

Low Capacitance ESD Protection Diodes for High-Speed Data Interfaces

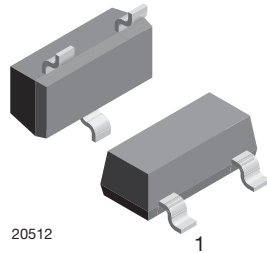

MARKING (example only)

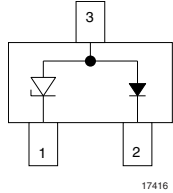
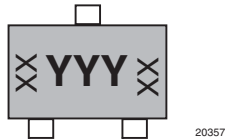

Bar = cathode marking

YYY = type code (see table below)

XX = date code

FEATURES

- IEC 61000-4-5 (lightning) see I_{PPM} below
- ESD-protection acc. IEC 61000-4-2
 ± 8 kV contact discharge
 ± 15 kV air discharge
- SOT-23 package
- High temperature soldering guaranteed:
 $260^\circ\text{C}/10$ s at terminals
- Low capacitance for high speed data lines, cellular handsets, USB port protection, LAN equipment, peripherals
- AEC-Q101 qualified
- e3 - Sn
- Material categorization: for definitions of compliance please see www.vishay.com/doc?99912



ORDERING INFORMATION							
PART NUMBER (EXAMPLE)	ENVIRONMENTAL AND QUALITY CODE				PACKAGING CODE		ORDERING CODE (EXAMPLE)
	AEC-Q101 QUALIFIED	RoHS-COMPLIANT + LEAD (Pb)-FREE		TIN PLATED	3K PER 7" REEL (8 mm TAPE), 15K/BOX = MOQ	10K PER 13" REEL (8 mm TAPE), 10K/BOX = MOQ	
		STANDARD	GREEN				
GL05T-		E		3	-08		GL05T-E3-08
GL05T-			G	3	-08		GL05T-G3-08
GL05T-	H	E		3	-08		GL05T-HE3-08
GL05T-	H		G	3	-08		GL05T-HG3-08
GL05T-		E		3		-18	GL05T-E3-18
GL05T-			G	3		-18	GL05T-G3-18
GL05T-	H	E		3		-18	GL05T-HE3-18
GL05T-	H		G	3		-18	GL05T-HG3-18

PACKAGE DATA							
DEVICE NAME	PACKAGE NAME	TYPE CODE	ENVIRONMENTAL STATUS	WEIGHT	MOLDING COMPOUND FLAMMABILITY RATING	MOISTURE SENSITIVITY LEVEL	SOLDERING CONDITIONS
GL05T	SOT-23	L05	Standard	8.8 mg	UL 94 V-0	MSL level 1 (according J-STD-020)	$260^\circ\text{C}/10$ s at terminals
		L06	Green	8.1 mg	UL 94 V-0	MSL level 1 (according J-STD-020)	$260^\circ\text{C}/10$ s at terminals
GL12T	SOT-23	L12	Standard	8.8 mg	UL 94 V-0	MSL level 1 (according J-STD-020)	$260^\circ\text{C}/10$ s at terminals
		L13	Green	8.1 mg	UL 94 V-0	MSL level 1 (according J-STD-020)	$260^\circ\text{C}/10$ s at terminals
GL15T	SOT-23	L15	Standard	8.8 mg	UL 94 V-0	MSL level 1 (according J-STD-020)	$260^\circ\text{C}/10$ s at terminals
		L16	Green	8.1 mg	UL 94 V-0	MSL level 1 (according J-STD-020)	$260^\circ\text{C}/10$ s at terminals
GL24T	SOT-23	L24	Standard	8.8 mg	UL 94 V-0	MSL level 1 (according J-STD-020)	$260^\circ\text{C}/10$ s at terminals
		L25	Green	8.1 mg	UL 94 V-0	MSL level 1 (according J-STD-020)	$260^\circ\text{C}/10$ s at terminals



ABSOLUTE MAXIMUM RATINGS GL05T					
PARAMETER	TEST CONDITIONS		SYMBOL	VALUE	UNIT
Peak pulse current	8/20 μ s	Pin 1-2 (pin 3 n.c.)	I_{PPM}	25	A
Peak pulse power	8/20 μ s waveform		P_{PP}	300	W
ESD immunity	Contact discharge acc. IEC 61000-4-2; 10 pulses		V_{ESD}	± 8	kV
	Air discharge acc. IEC 61000-4-2; 10 pulses			± 15	kV
Blocking voltage	$I_B = 1 \mu A$	Pin 2-1 or pin 2-3	V_B	70	V
Operating temperature	Junction temperature		T_J	-55 to +150	$^{\circ}C$
Storage temperature			T_{STG}	-55 to +150	$^{\circ}C$

ABSOLUTE MAXIMUM RATINGS GL12T					
PARAMETER	TEST CONDITIONS		SYMBOL	VALUE	UNIT
Peak pulse current	8/20 μ s	Pin 1-2 (pin 3 n.c.)	I_{PPM}	12	A
Peak pulse power	8/20 μ s waveform		P_{PP}	300	W
ESD immunity	Contact discharge acc. IEC 61000-4-2; 10 pulses		V_{ESD}	± 8	kV
	Air discharge acc. IEC 61000-4-2; 10 pulses			± 15	kV
Blocking voltage	$I_B = 1 \mu A$	Pin 2-1 or pin 2-3	V_B	70	V
Operating temperature	Junction temperature		T_J	-55 to +150	$^{\circ}C$
Storage temperature			T_{STG}	-55 to +150	$^{\circ}C$

ABSOLUTE MAXIMUM RATINGS GL15T					
PARAMETER	TEST CONDITIONS		SYMBOL	VALUE	UNIT
Peak pulse current	8/20 μ s	Pin 1-2 (pin 3 n.c.)	I_{PPM}	10	A
Peak pulse power	8/20 μ s waveform		P_{PP}	300	W
ESD immunity	Contact discharge acc. IEC 61000-4-2; 10 pulses		V_{ESD}	± 8	kV
	Air discharge acc. IEC 61000-4-2; 10 pulses			± 15	kV
Blocking voltage	$I_B = 1 \mu A$	Pin 2-1 or pin 2-3	V_B	70	V
Operating temperature	Junction temperature		T_J	-55 to +150	$^{\circ}C$
Storage temperature			T_{STG}	-55 to +150	$^{\circ}C$

ABSOLUTE MAXIMUM RATINGS GL24T					
PARAMETER	TEST CONDITIONS		SYMBOL	VALUE	UNIT
Peak pulse current	8/20 μ s	Pin 1-2 (pin 3 n.c.)	I_{PPM}	5	A
Peak pulse power	8/20 μ s waveform		P_{PP}	300	W
ESD immunity	Contact discharge acc. IEC 61000-4-2; 10 pulses		V_{ESD}	± 8	kV
	Air discharge acc. IEC 61000-4-2; 10 pulses			± 15	kV
Blocking voltage	$I_B = 1 \mu A$	Pin 2-1 or pin 2-3	V_B	70	V
Operating temperature	Junction temperature		T_J	-55 to +150	$^{\circ}C$
Storage temperature			T_{STG}	-55 to +150	$^{\circ}C$

The GLxxT contains an avalanche diode (pin 3-1) and a switching diode (pin 3-2). With pin 1 connected to the signal or data line and pin 2 connected to ground both diodes are in series (pin 3 remains unconnected). The big and robust avalanche diode, driven in reverse direction, provides the working range V_{RWM} of 5 V, 12 V, 15 V or 24 V. Due to its size the capacitance of the avalanche diode is in the range of typ. 260 pF (GL05T) and 65 pF (GL24T). The small switching diode in series has a low capacitance of just 2.5 pF (typ.). As both diodes are in series (with pin 3 not connected) the total capacitance of both diodes measured between pin 1 and 2 is as low as the capacitance of the switching diode.

Before the GLxxT can provide this low capacitance the big capacitance of the avalanche diode has to be charged up with the first signal or data pulses. This is usually no problem for digital signals like USB or other data ports.

With the GLxxT a signal or data line can be protected against positive transients only. For negative transients another GLxxT can be used to provide a back path for the negative transients as well.

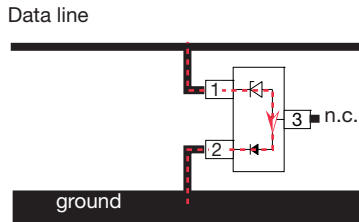

Uni
Unidirectional clamping performance for **positive** transients only.

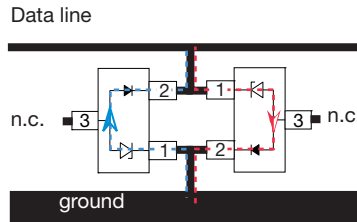

BiSy
Bidirectional and **Symmetrical** clamping performance for **positive** and **negative** transients.

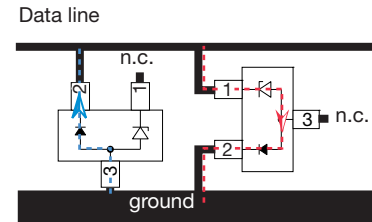

BiAs
Bidirectional and **Asymmetrical** clamping performance for **positive** and **negative** transients.

ELECTRICAL CHARACTERISTICS GL05T ($T_{amb} = 25\text{ }^{\circ}\text{C}$ unless otherwise specified)
pin 1 to pin 2; pin 3 not connected

PARAMETER	TEST CONDITIONS/REMARKS	SYMBOL	MIN.	TYP.	MAX.	UNIT
Protection paths	Number of lines which can be protected	$N_{channel}$	-	-	1	lines
Reverse stand-off voltage		V_{RWM}	-	-	5	V
Reverse voltage	at $I_R = 20\text{ }\mu\text{A}$	V_R	5	-	-	V
Reverse current	at $V_R = 5\text{ V}$	I_R	-	-	20	μA
Reverse breakdown voltage	at $I_R = 1\text{ mA}$	V_{BR}	6.9	7.5	8.0	V
Reverse clamping voltage	at $I_{PP} = 1\text{ A}$	V_C	-	-	9.8	V
	at $I_{PP} = 5\text{ A}$		-	-	11	V
Capacitance	at $V_R = 0\text{ V}$; $f = 1\text{ MHz}$	C_D	-	2.5	5	pF

ELECTRICAL CHARACTERISTICS GL12T ($T_{amb} = 25\text{ }^{\circ}\text{C}$ unless otherwise specified)
pin 1 to pin 2; pin 3 not connected

PARAMETER	TEST CONDITIONS/REMARKS	SYMBOL	MIN.	TYP.	MAX.	UNIT
Protection paths	Number of lines which can be protected	$N_{channel}$	-	-	1	lines
Reverse stand-off voltage		V_{RWM}	-	-	12	V
Reverse voltage	at $I_R = 1\text{ }\mu\text{A}$	V_R	12	-	-	V
Reverse current	at $V_R = 12\text{ V}$	I_R	-	-	1	μA
Reverse breakdown voltage	at $I_R = 1\text{ mA}$	V_{BR}	13.3	14.3	17.2	V
Reverse clamping voltage	at $I_{PP} = 1\text{ A}$	V_C	-	-	19	V
	at $I_{PP} = 5\text{ A}$		-	-	24	V
Capacitance	at $V_R = 0\text{ V}$; $f = 1\text{ MHz}$	C_D	-	2.5	5	pF

ELECTRICAL CHARACTERISTICS GL15T ($T_{amb} = 25\text{ }^{\circ}\text{C}$ unless otherwise specified)
pin 1 to pin 2; pin 3 not connected

PARAMETER	TEST CONDITIONS/REMARKS	SYMBOL	MIN.	TYP.	MAX.	UNIT
Protection paths	Number of lines which can be protected	$N_{channel}$	-	-	1	lines
Reverse stand-off voltage		V_{RWM}	-	-	15	V
Reverse voltage	at $I_R = 1\text{ }\mu\text{A}$	V_R	15	-	-	V
Reverse current	at $V_R = 15\text{ V}$	I_R	-	-	1	μA
Reverse breakdown voltage	at $I_R = 1\text{ mA}$	V_{BR}	16.7	17.7	22	V
Reverse clamping voltage	at $I_{PP} = 1\text{ A}$	V_C	-	-	24	V
	at $I_{PP} = 5\text{ A}$		-	-	33	V
Capacitance	at $V_R = 0\text{ V}$; $f = 1\text{ MHz}$	C_D	-	2.5	5	pF



ELECTRICAL CHARACTERISTICS GL24T ($T_{amb} = 25\text{ }^{\circ}\text{C}$ unless otherwise specified) pin 1 to pin 2; pin 3 not connected						
PARAMETER	TEST CONDITIONS/REMARKS	SYMBOL	MIN.	TYP.	MAX.	UNIT
Protection paths	Number of lines which can be protected	$N_{channel}$	-	-	1	lines
Reverse stand-off voltage		V_{RWM}	-	-	24	V
Reverse voltage	at $I_R = 1\text{ }\mu\text{A}$	V_R	24	-	-	V
Reverse current	at $V_R = 24\text{ V}$	I_R	-	-	1	μA
Reverse breakdown voltage	at $I_R = 1\text{ mA}$	V_{BR}	26.7	28.2	33	V
Reverse clamping voltage	at $I_{PP} = 1\text{ A}$	V_C	-	-	43	V
	at $I_{PP} = 5\text{ A}$		-	-	55	V
Capacitance	at $V_R = 0\text{ V}$; $f = 1\text{ MHz}$	C_D	-	2.5	5	pF

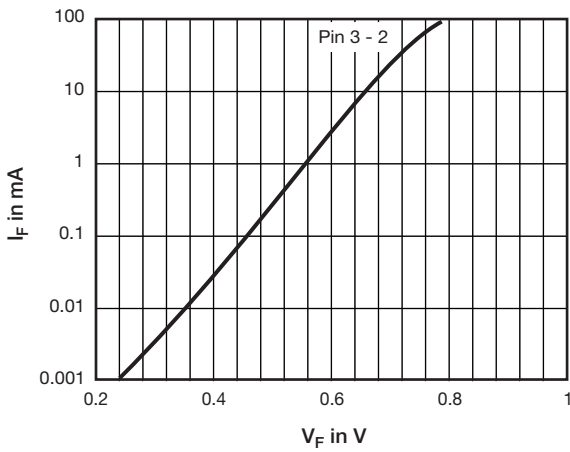

Fig. 1 - Typical Forward Current I_F vs. Forward Voltage V_F

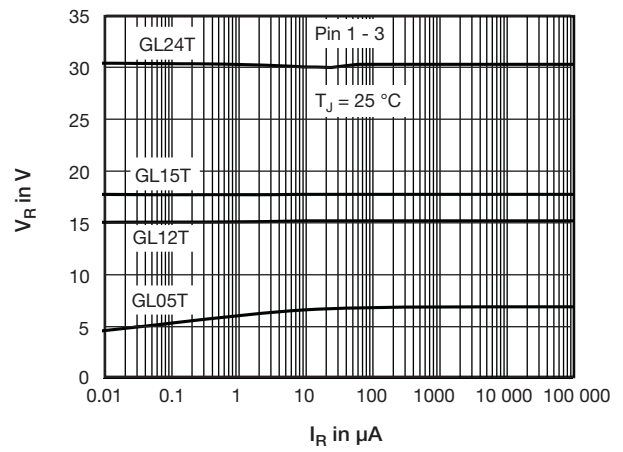

Fig. 3 - Typical Reverse Voltage V_R vs. Reverse Current I_R

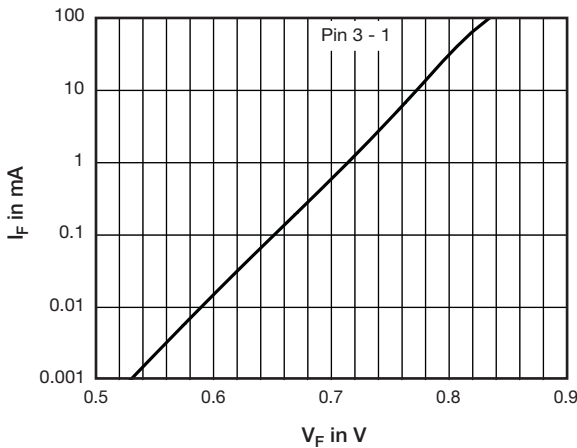
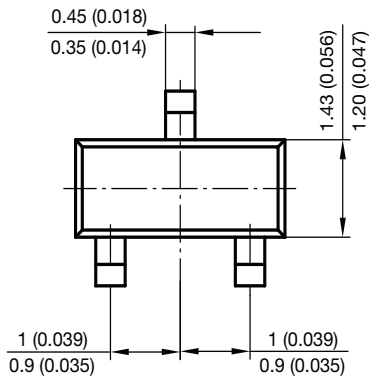
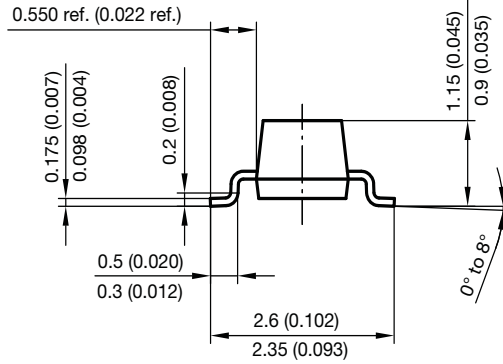
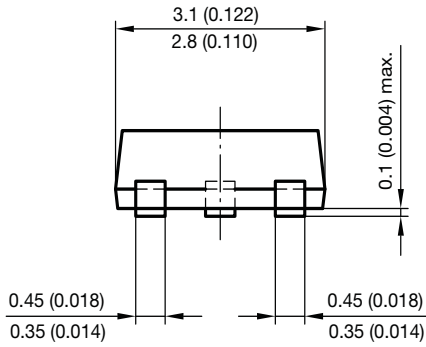

Fig. 2 - Typical Forward Current I_F vs. Forward Voltage V_F



PACKAGE DIMENSIONS in millimeters (inches): **SOT-23**



Foot print recommendation:

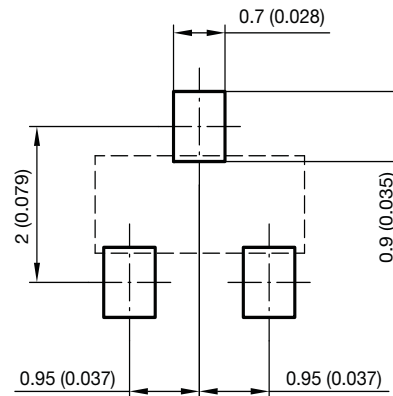

Document no.: 6.541-5014.01-4
Rev. 8 - Date: 23.Sept.2009
17418

Unreeling direction →

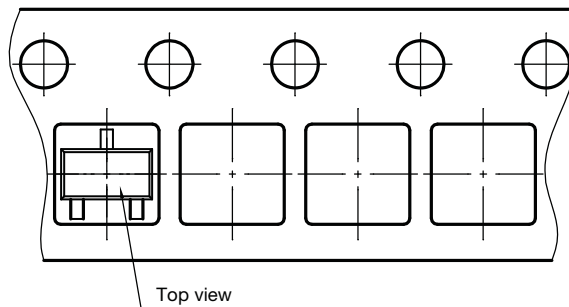

SOT-23

Orientation in carrier tape
SOT-23
S8-V-3929.01-006 (4)
04.02.2010
22607



Disclaimer

ALL PRODUCT, PRODUCT SPECIFICATIONS AND DATA ARE SUBJECT TO CHANGE WITHOUT NOTICE TO IMPROVE RELIABILITY, FUNCTION OR DESIGN OR OTHERWISE.

Vishay Intertechnology, Inc., its affiliates, agents, and employees, and all persons acting on its or their behalf (collectively, "Vishay"), disclaim any and all liability for any errors, inaccuracies or incompleteness contained in any datasheet or in any other disclosure relating to any product.

Vishay makes no warranty, representation or guarantee regarding the suitability of the products for any particular purpose or the continuing production of any product. To the maximum extent permitted by applicable law, Vishay disclaims (i) any and all liability arising out of the application or use of any product, (ii) any and all liability, including without limitation special, consequential or incidental damages, and (iii) any and all implied warranties, including warranties of fitness for particular purpose, non-infringement and merchantability.

Statements regarding the suitability of products for certain types of applications are based on Vishay's knowledge of typical requirements that are often placed on Vishay products in generic applications. Such statements are not binding statements about the suitability of products for a particular application. It is the customer's responsibility to validate that a particular product with the properties described in the product specification is suitable for use in a particular application. Parameters provided in datasheets and/or specifications may vary in different applications and performance may vary over time. All operating parameters, including typical parameters, must be validated for each customer application by the customer's technical experts. Product specifications do not expand or otherwise modify Vishay's terms and conditions of purchase, including but not limited to the warranty expressed therein.

Except as expressly indicated in writing, Vishay products are not designed for use in medical, life-saving, or life-sustaining applications or for any other application in which the failure of the Vishay product could result in personal injury or death. Customers using or selling Vishay products not expressly indicated for use in such applications do so at their own risk. Please contact authorized Vishay personnel to obtain written terms and conditions regarding products designed for such applications.

No license, express or implied, by estoppel or otherwise, to any intellectual property rights is granted by this document or by any conduct of Vishay. Product names and markings noted herein may be trademarks of their respective owners.

Material Category Policy

Vishay Intertechnology, Inc. hereby certifies that all its products that are identified as RoHS-Compliant fulfill the definitions and restrictions defined under Directive 2011/65/EU of The European Parliament and of the Council of June 8, 2011 on the restriction of the use of certain hazardous substances in electrical and electronic equipment (EEE) - recast, unless otherwise specified as non-compliant.

Please note that some Vishay documentation may still make reference to RoHS Directive 2002/95/EC. We confirm that all the products identified as being compliant to Directive 2002/95/EC conform to Directive 2011/65/EU.

Vishay Intertechnology, Inc. hereby certifies that all its products that are identified as Halogen-Free follow Halogen-Free requirements as per JEDEC JS709A standards. Please note that some Vishay documentation may still make reference to the IEC 61249-2-21 definition. We confirm that all the products identified as being compliant to IEC 61249-2-21 conform to JEDEC JS709A standards.