

GRM1556T1H2R2CD01#

"#" indicates a package specification code.



< List of part numbers with package codes >
 GRM1556T1H2R2CD01D , GRM1556T1H2R2CD01W , GRM1556T1H2R2CD01J

Shape

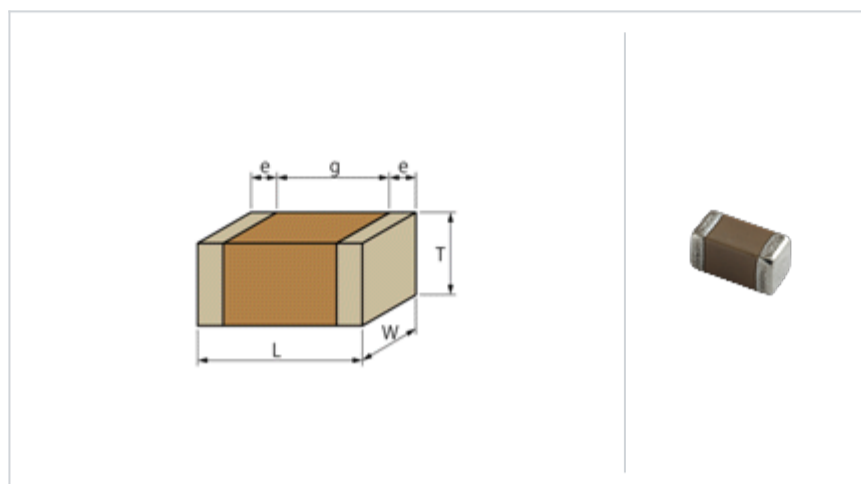

L size	1.0 ± 0.05mm
W size	0.5 ± 0.05mm
T size	0.5 ± 0.05mm
External terminal width e	0.15 to 0.35mm
Distance between external terminals g	0.3mm min.
Size code in inch(mm)	0402 (1005)

References

Packaging	Specifications	Minimum quantity
D	180mm Paper taping	10000
J	330mm Paper taping	50000
W	180mm Paper taping (W8P1*) * Width : 8mm, Pocket pitch : 1mm	20000

Mass (typ.)	
1 piece	1.6mg
180mm Reel	118g

Specifications

Capacitance	2.2pF ± 0.25pF
Rated voltage	50Vdc
Temperature characteristics (complied standard)	T2H(EIA)
Temperature coefficient	-470 ± 60ppm/
Temperature range of temperature characteristics	25 to 85
Operating temperature range	-55 to 125

⚠ Attention

- 1.This datasheet is downloaded from the website of Murata Manufacturing Co., Ltd. Therefore, it ' s specifications are subject to change or our products in it may be discontinued without advance notice. Please check with our sales representatives or product engineers before ordering.
- 2.This datasheet has only typical specifications because there is no space for detailed specifications. Therefore, please review our product specifications or consult the approval sheet for product specifications before ordering.