

THIS DRAWING IS UNPUBLISHED. RELEASED FOR PUBLICATION 20  
 © COPYRIGHT 20 Y ALL RIGHTS RESERVED.

LOC H DIST -

REVISIONS

P	LTR	DESCRIPTION	DATE	DWN	APVD
	G	Adhesive tape width changed from 6 mm to 9 mm	13NOV2014	NV	PS

REFERENCE MATING INTERFACE PATTERN:  
 1,27 STAGGERED PITCH x 1,5 ROW-DISTANCE.

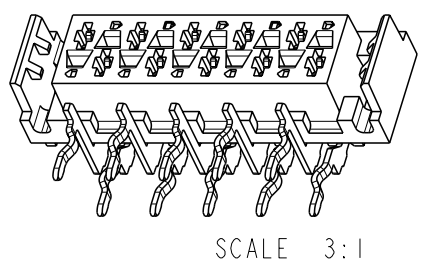
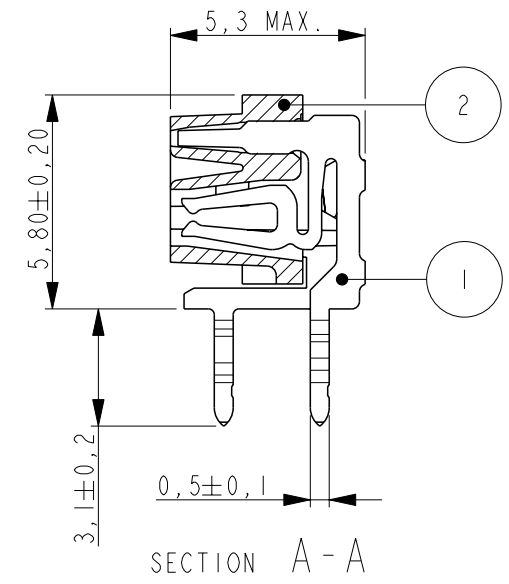
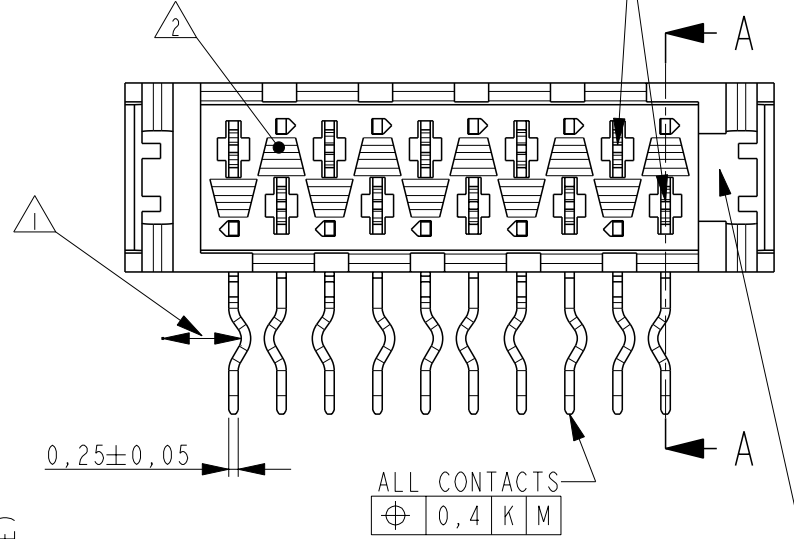

PART NUMBER	NR. OF POS "n"	"A" MAX
338070-4	4	9,7
338070-6	6	12,2
338070-8	8	14,7
1-338070-0	10	17,3
1-338070-2	12	19,8
1-338070-4	14	22,4
1-338070-6	16	24,9
1-338070-8	18	27,4
2-338070-0	20	30,0

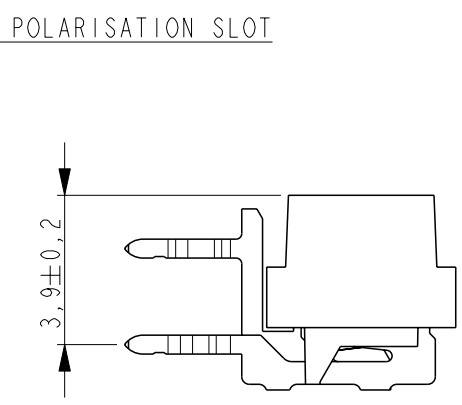
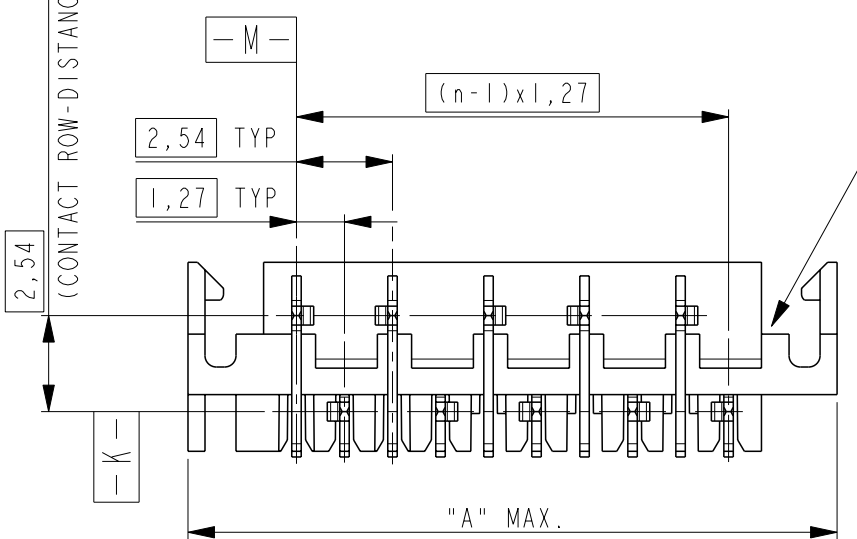

NOTES:

- 1 IN EACH ROW, DIRECTION OF KINKS STARTS RANDOM. IN EACH ROW, SEQUENTIAL CONTACTS HAVE OPPOSITE KINK DIRECTIONS.
- 2 CORING-OUTS FOR MANUFACTURING PURPOSE ONLY. SHAPE MAY VARY, BUT IS NOT FUNCTIONAL FOR THE APPLICATION.
- 3 SHOWN IS A 10 POSITION CONNECTOR.
- 4 THIS AREA IS RESERVED FOR CONTACTS.

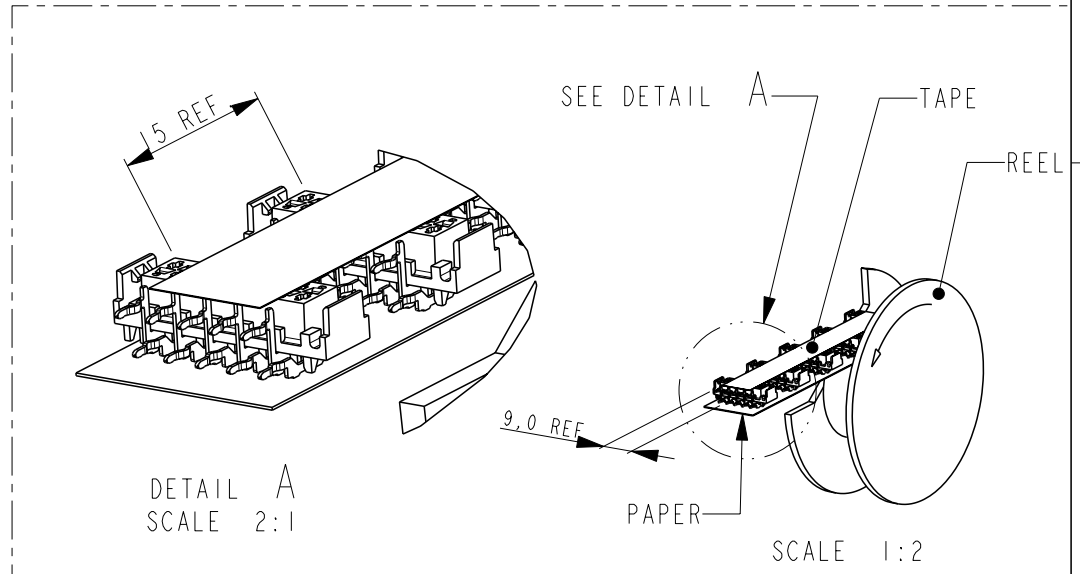

REEL PACKAGING  
 DEREELING DIRECTION AND CONNECTOR POSITION.  
 QUANTITY 2500 CONNECTORS PER REEL FOR ALL PART NUMBER,

PC-BOARD HOLE LAYOUT  
 (COMPONENT SIDE OF BOARD SHOWN)

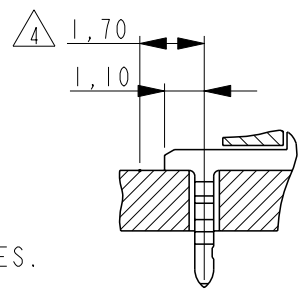
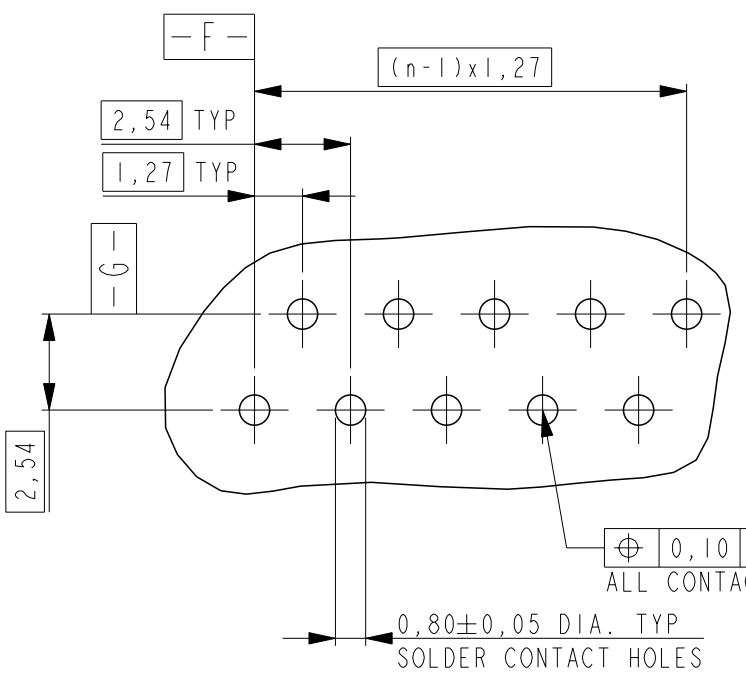

THIS DRAWING IS A CONTROLLED DOCUMENT.

DIMENSIONS:	TOLERANCES UNLESS OTHERWISE SPECIFIED:
mm	0 PLC ±-
	1 PLC ±-
	2 PLC ±-
	3 PLC ±-
	4 PLC ±-
	ANGLES ±1°
MATERIAL	FINISH

ITEM NO.	DESCRIPTION	MATERIAL	FINISH / COLOR
2	HOUSING	G.F. POLYESTER PBT	RED
1	FEMALE CONTACT	PHOSPHOR BRONZE	TIN OVER NICKEL

DWN 03-JUN-96 DENNIS KESSLER  
 CHK HUUB VAN DELFT  
 APVD ERIC LEIJTENS  
 PRODUCT SPEC 108-19052  
 APPLICATION SPEC -  
 WEIGHT -  
 Customer Drawing

**STE** TE Connectivity  
 NAME: CONNECTOR, FEMALE-ON-BOARD, SIDE-ENTRY, THRU-HOLE, WITH LATCHES, Micro-MatCh  
 SIZE: A3 CAGE CODE: 00779 DRAWING NO: C-338070 RESTRICTED TO: -  
 SCALE: 10:1 SHEET: 1 OF 1 REV: G