

## DS92001 3.3V B/LVDS-BLVDS Buffer

Check for Samples: [DS92001](#)

### FEATURES

- **Single +3.3 V Supply**
- **Receiver Inputs Accept LVDS/CML/LVPECL Signals**
- **TRI-STATE Outputs**
- **Receiver Input Threshold <  $\pm 100$  mV**
- **Fast Propagation Delay of 1.4 ns (typ)**
- **Low Jitter 400 Mbps Fully Differential Data Path**
- **Compatible with BLVDS 10-bit SerDes (40MHz)**
- **Compatible with ANSI/TIA/EIA-644-A LVDS Standard**
- **Available in SOIC and Space Saving WSON Package**
- **Industrial Temperature Range**

### DESCRIPTION

The DS92001 B/LVDS-BLVDS Buffer takes a BLVDS input signal and provides a BLVDS output signal. In many large systems, signals are distributed across backplanes. One of the limiting factors for system speed is the "stub length" or the distance between the transmission line and the unterminated receivers on individual cards. Although it is generally recognized that this distance should be as short as possible to maximize system performance, real-world packaging concerns often make it difficult to make the stubs as short as the designer would like.

The DS92001 has edge transitions optimized for multidrop backplanes where the switching frequency is in the 200 MHz range or less. The output edge rate is critical in some systems where long stubs may be present, and utilizing a slow transition allows for longer stub lengths.

The DS92001, available in the WSON package, will allow the receiver inputs to be placed very close to the main transmission line, thus improving system performance.

A wide input dynamic range allows the DS92001 to receive differential signals from LVPECL, CML as well as LVDS sources. This will allow the device to also fill the role of an LVPECL-BLVDS or CML-BLVDS translator.

### Connection and Block Diagrams

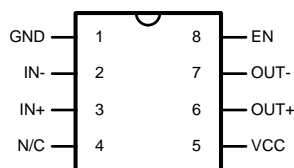

**Figure 1. SOIC Package Number D0008A  
Top View**

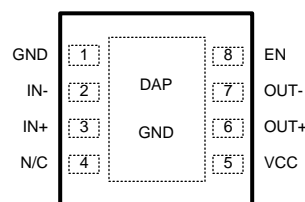

**Figure 2. WSON Package Number NGK0008A  
Top View**

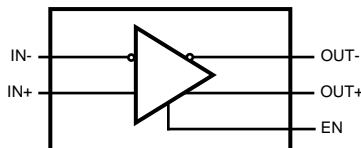

Please be aware that an important notice concerning availability, standard warranty, and use in critical applications of Texas Instruments semiconductor products and disclaimers thereto appears at the end of this data sheet.

All trademarks are the property of their respective owners.

**Table 1. Functional Operation**

BLVDS Inputs [IN+] – [IN-]	BLVDS Outputs	
	OUT+	OUT-
$VID \geq 0.1V$	H	L
$VID \leq -0.1V$	L	H
$-0.1V \leq VID \leq 0.1V$	Undefined	Undefined



These devices have limited built-in ESD protection. The leads should be shorted together or the device placed in conductive foam during storage or handling to prevent electrostatic damage to the MOS gates.

**Absolute Maximum Ratings<sup>(1)(2)</sup>**

Supply Voltage ( $V_{CC}$ )		-0.3V to +4V
LVC MOS/LVTTL Input Voltage (EN)		-0.3V to ( $V_{CC} + 0.3V$ )
B/LVDS Receiver Input Voltage (IN+, IN-)		-0.3V to +4V
BLVDS Driver Output Voltage (OUT+, OUT-)		-0.3V to +4V
BLVDS Output Short Circuit Current		Continuous
Junction Temperature		+150°C
Storage Temperature Range		-65°C to +150°C
Lead Temperature Range Soldering (4 sec.)		+260°C
Maximum Package Power Dissipation at 25°C	D Package	726 mW
	Derate D Package	5.8 mW/°C above +25°C
	NGK Package	2.44 W
	Derate NGK Package	19.49 mW/°C above +25°C
ESD Ratings	(HBM, 1.5kΩ, 100pF)	≥2.5kV
	(EIAJ, 0Ω, 200pF)	≥250V

- (1) "Absolute Maximum Ratings" are those values beyond which the safety of the device cannot be ensured. They are not meant to imply that the device should be operated at these limits. The table of "Electrical Characteristics" specifies conditions of device operation.
- (2) If Military/Aerospace specified devices are required, please contact the TI Sales Office/Distributors for availability and specifications.

**Recommended Operating Conditions**

	Min	Typ	Max	Units
Supply Voltage ( $V_{CC}$ )	3.0	3.3	3.6	V
Receiver Differential Input Voltage ( $V_{ID}$ ) with $V_{CM}=1.2V$	0.1		2.4	V
Operating Free Air Temperature	-40	+25	+85	°C
B/LVDS Input Rise/Fall 20% to 80%		2	20	ns

## Electrical Characteristics

Over recommended operating supply and temperature ranges unless otherwise specified. <sup>(1)(2)</sup>

Symbol	Parameter	Conditions	Min	Typ	Max	Units
<b>LVC MOS/LVTTL DC SPECIFICATIONS (EN)</b>						
V <sub>IH</sub>	High Level Input Voltage		2.0		V <sub>CC</sub>	V
V <sub>IL</sub>	Low Level Input Voltage		GND		0.8	V
I <sub>IH</sub>	High Level Input Current	V <sub>IN</sub> = V <sub>CC</sub> or 2.0V		+7	+20	μA
I <sub>IL</sub>	Low Level Input Current	V <sub>IN</sub> = GND or 0.8V	-10	±1	+10	μA
V <sub>CL</sub>	Input Clamp Voltage	I <sub>CL</sub> = -18 mA		-0.6	-1.5	V
<b>BLVDS OUTPUT DC SPECIFICATIONS (OUT)</b>						
V <sub>OD</sub>	Differential Output Voltage <sup>(1)</sup>	R <sub>L</sub> = 27Ω	250	350	500	mV
		R <sub>L</sub> = 50Ω	350	450	600	mV
ΔV <sub>OD</sub>	Change in Magnitude of V <sub>OD</sub> for Complimentary Output States	R <sub>L</sub> = 27Ω or 50Ω See <a href="#">Figure 3</a> and <a href="#">Figure 4</a>			20	mV
V <sub>OS</sub>	Offset Voltage	R <sub>L</sub> = 27Ω or R <sub>L</sub> = 50Ω	1.1	1.25	1.375	V
ΔV <sub>OS</sub>	Change in Magnitude of V <sub>OS</sub> for Complimentary Output States	See <a href="#">Figure 3</a>		2	20	mV
I <sub>OZ</sub>	Output TRI-STATE Current	EN = 0V, V <sub>OUT</sub> = V <sub>CC</sub> or GND	-20	±5	+20	μA
I <sub>OFF</sub>	Power-Off Leakage Current	V <sub>CC</sub> = 0V or Open Circuit, V <sub>OUT</sub> = 3.6V	-20	±5	+20	μA
I <sub>OS1</sub>	Output Short Circuit Current <sup>(3)</sup>	EN = V <sub>CC</sub> , V <sub>CM</sub> = 1.2V, V <sub>ID</sub> = 200mV, V <sub>OUT+</sub> = 0V, or V <sub>ID</sub> = -200mV, V <sub>CM</sub> = 1.2V, V <sub>OUT-</sub> = 0V		-30	-60	mA
		V <sub>ID</sub> = -200mV, V <sub>CM</sub> = 1.2V, V <sub>OUT+</sub> = V <sub>CC</sub> , or V <sub>ID</sub> = 200mV, V <sub>CM</sub> = 1.2V, V <sub>OUT-</sub> = V <sub>CC</sub>		53	80	mA
I <sub>OSD</sub>	Differential Output Short Circuit Current <sup>(3)</sup>	EN = V <sub>CC</sub> , V <sub>ID</sub> =  200mV , V <sub>CM</sub> = 1.2V, V <sub>OD</sub> = 0V (connect true and complement outputs through a current meter)		30	42	mA
<b>B/LVDS RECEIVER DC SPECIFICATIONS (IN)</b>						
V <sub>TH</sub>	Differential Input High Threshold <sup>(4)</sup>	V <sub>CM</sub> = +0.05V, +1.2V or +3.25V		-30	-5	mV
V <sub>TL</sub>	Differential Input Low Threshold <sup>(4)</sup>		-70	-30		mV
V <sub>CMR</sub>	Common Mode Voltage Range <sup>(4)</sup>		V <sub>ID</sub>  /2		V <sub>CC</sub> - V <sub>ID</sub>  /2	V
I <sub>IN</sub>	Input Current	V <sub>IN</sub> = V <sub>CC</sub>	V <sub>CC</sub> = 3.6V or 0V	1.5	20	μA
		V <sub>IN</sub> = 0V		1.5	20	μA
ΔI <sub>IN</sub>	Change in Magnitude of I <sub>IN</sub>	V <sub>IN</sub> = V <sub>CC</sub>		1	6	μA
		V <sub>IN</sub> = 0V		1	6	μA
<b>SUPPLY CURRENT</b>						
I <sub>CCD</sub>	Total Dynamic Supply Current (includes load current)	EN = V <sub>CC</sub> , R <sub>L</sub> = 27Ω or 50Ω, C <sub>L</sub> = 15 pF, Freq. = 200MHz 50% duty cycle, V <sub>ID</sub> = 200mV, V <sub>CM</sub> = 1.2V		50	65	mA
I <sub>CCZ</sub>	TRI-STATE Supply Current	EN = 0V, Freq. = 200MHz 50% duty cycle, V <sub>ID</sub> = 200mV, V <sub>CM</sub> = 1.2V		36	46	mA

- (1) Current into device pins is defined as positive. Current out of device pins is defined as negative. All voltages are referenced to ground except V<sub>ID</sub>, V<sub>OD</sub>, V<sub>TH</sub>, V<sub>TL</sub>, and ΔV<sub>OD</sub>. V<sub>OD</sub> has a value and direction. Positive direction means OUT+ is a more positive voltage than OUT-.
- (2) All typical are given for V<sub>CC</sub> = +3.3V and T<sub>A</sub> = +25°C, unless otherwise stated.
- (3) Output short circuit current (I<sub>OS</sub>) is specified as magnitude only, minus sign indicates direction only.
- (4) The parameters are specified by design. The limits are based on statistical analysis of the device performance over the PVT (process, voltage and temperature) range.

## AC Electrical Characteristics

Over recommended operating supply and temperature ranges unless otherwise specified.<sup>(1)</sup>

Symbol	Parameter	Conditions	Min	Typ	Max	Units
<b>LVDS OUTPUT AC SPECIFICATIONS (OUT)</b>						
$t_{PHLD}$	Differential Propagation Delay High to Low <sup>(2)</sup>	$V_{ID} = 200\text{mV}$ , $V_{CM} = 1.2\text{V}$ , $R_L = 27\Omega$ or $50\Omega$ , $C_L = 15\text{pF}$ See <a href="#">Figure 5</a> and <a href="#">Figure 6</a>	1.0	1.4	2.0	ns
$t_{PLHD}$	Differential Propagation Delay Low to High <sup>(2)</sup>		1.0	1.4	2.0	ns
$t_{SKD1}$	Pulse Skew $ t_{PLHD} - t_{PHLD} $ (measure of duty cycle) <sup>(3)(4)</sup>		0	20	200	ps
$t_{SKD3}$	Part-to-Part Skew <sup>(3)(5)</sup>		0	200	300	ps
$t_{SKD4}$	Part-to-Part Skew <sup>(3)(6)</sup>		0		1	ns
$t_{LHT}$	Rise Time <sup>(3)(2)</sup> 20% to 80% points	$R_L = 50\Omega$ or $27\Omega$ , $C_L = 15\text{pF}$ See <a href="#">Figure 5</a> and <a href="#">Figure 7</a>	0.350	0.6	1.0	ns
$t_{HLT}$	Fall Time <sup>(3)(2)</sup> 80% to 20% points		0.350	0.6	1.0	ns
$t_{PHZ}$	Disable Time (Active High to Z)	$R_L = 50\Omega$ , $C_L = 15\text{pF}$ See <a href="#">Figure 8</a> and <a href="#">Figure 9</a>		3	25	ns
$t_{PLZ}$	Disable Time (Active Low to Z)			3	25	ns
$t_{PZH}$	Enable Time (Z to Active High)			100	120	ns
$t_{PZL}$	Enable Time (Z to Active Low)			100	120	ns
$t_{DJ}$	LVDS Data Jitter, Deterministic (Peak-to-Peak) <sup>(7)</sup>	$V_{ID} = 300\text{mV}$ ; PRBS = $2^{23} - 1$ data; $V_{CM} = 1.2\text{V}$ at 400Mbps (NRZ)			78	ps
$t_{RJ}$	LVDS Clock Jitter, Random <sup>(7)</sup>	$V_{ID} = 300\text{mV}$ ; $V_{CM} = 1.2\text{V}$ at 200MHz clock			36	ps
$f_{MAX}$	Maximum specified frequency <sup>(8)</sup>	$V_{ID} = 200\text{mV}$ , $V_{CM} = 1.2\text{V}$	200	300		MHz

- (1) All typical are given for  $V_{CC} = +3.3\text{V}$  and  $T_A = +25^\circ\text{C}$ , unless otherwise stated.
- (2) Propagation delay, rise and fall times are specified by design and characterization to 200MHz. Generator for these tests:  $50\text{MHz} \leq f \leq 200\text{MHz}$ ,  $Z_o = 50\Omega$ ,  $t_r, t_f \leq 0.5\text{ns}$ . Generator used was HP8130A (300MHz capability).
- (3) The parameters are specified by design. The limits are based on statistical analysis of the device performance over the PVT (process, voltage and temperature) range.
- (4)  $t_{SKD1}$ :  $|t_{PLHD} - t_{PHLD}|$ , is the magnitude difference in differential propagation delay time between the positive going edge and the negative going edge of the same channel (a measure of duty cycle).
- (5)  $t_{SKD3}$ : Part to Part Skew, is defined as the difference between the minimum and maximum specified differential propagation delays. This specification applies to devices at the same  $V_{CC}$  and within  $5^\circ\text{C}$  of each other within the operating temperature range. This parameter specified by design and characterization.
- (6)  $t_{SKD4}$ : Part to Part Skew, is the differential channel-to-channel skew of any event between devices. This specification applies to devices over recommended operating temperature and voltage ranges, and across process distribution.  $t_{SKD4}$  is defined as  $|Max - Min|$  differential propagation delay.
- (7) The parameters are specified by design. The limits are based on statistical analysis of the device performance over the PVT range with the following test equipment setup: Agilent 86130A used as stimulus, 5 feet of RG142B cable with DUT test board and Agilent 86100A (digital scope mainframe) with Agilent 86122A (20GHz scope module). Data input jitter pk to pk = 22 picoseconds; Clock input jitter = 24 picoseconds;  $t_{DJ}$  measured 100 picoseconds,  $t_{RJ}$  measured 60 picoseconds.
- (8)  $f_{MAX}$  test: Generator (HP8133A or equivalent), Input duty cycle = 50%. Output criteria:  $V_{OD} \geq 200\text{mV}$ , Duty Cycle better than 45/55%. This specification is specified by design and characterization. A minimum is specified, which means that the device will operate to specified conditions from DC to the minimum specified AC frequency. The typical value is always greater than the minimum specification.

DC Test Circuits

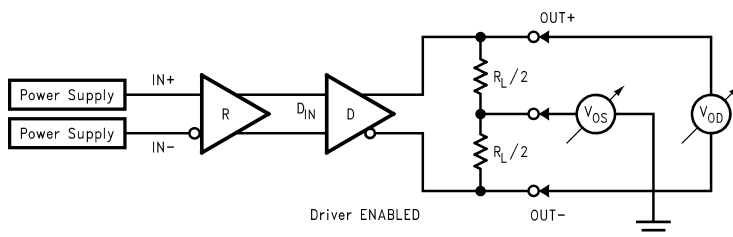

Figure 3. Differential Driver DC Test Circuit

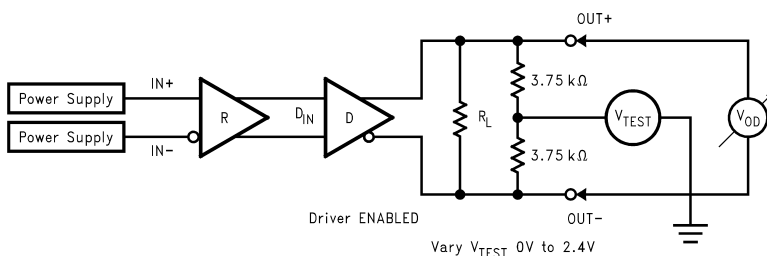

Figure 4. Differential Driver Full Load DC Test Circuit

AC Test Circuits and Timing Diagrams

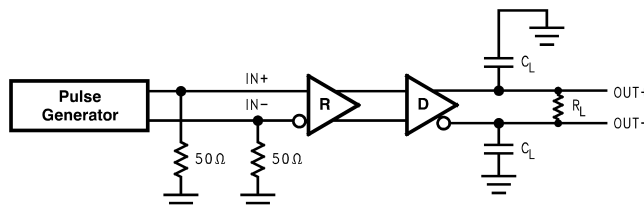

Figure 5. BLVDS Output Load

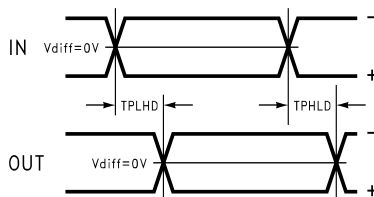

Figure 6. Propagation Delay Low-to-High and High-to-Low

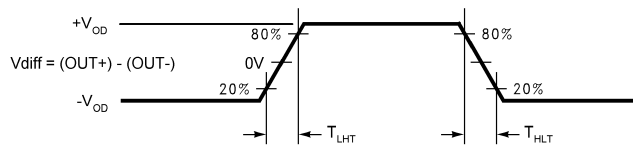

Figure 7. BLVDS Output Transition Time

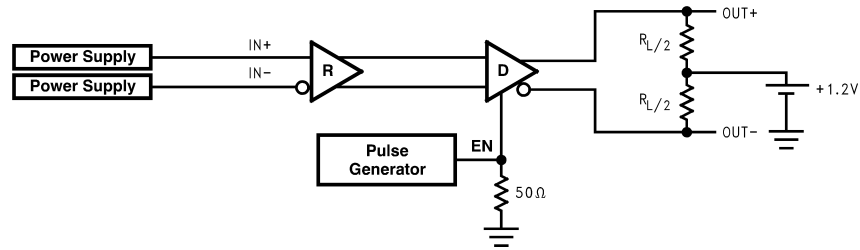

Figure 8. TRI-STATE Delay Test Circuit

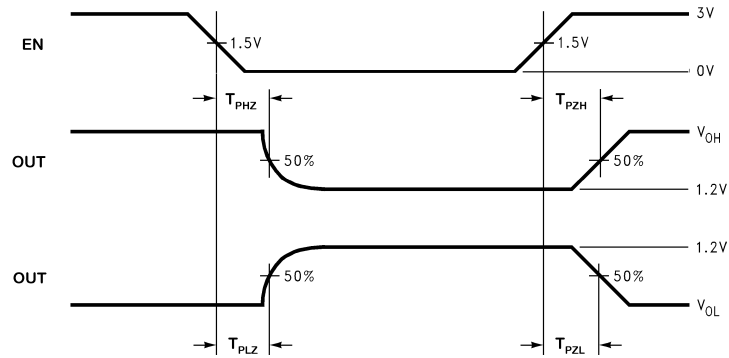

Figure 9. Output active to TRI-STATE and TRI-STATE to active output time

## PIN DESCRIPTIONS

Pin Name	Pin #	Input/Output	Description
GND	1	P	Ground
IN -	2	I	Inverting receiver B/LVDS input pin
IN+	3	I	Non-inverting receiver B/LVDS input pin
N/C	4	NA	"NO CONNECT" pin
V <sub>CC</sub>	5	P	Power Supply, 3.3V ± 0.3V.
OUT+	6	O	Non-inverting driver BLVDS output pin
OUT -	7	O	Inverting driver BLVDS output pin
EN	8	I	Enable pin. When EN is LOW, the driver is disabled and the BLVDS outputs are in TRI-STATE. When EN is HIGH, the driver is enabled. LVCMOS/LVTTL levels.
GND	DAP	P	WSON Package Ground

Typical Applications

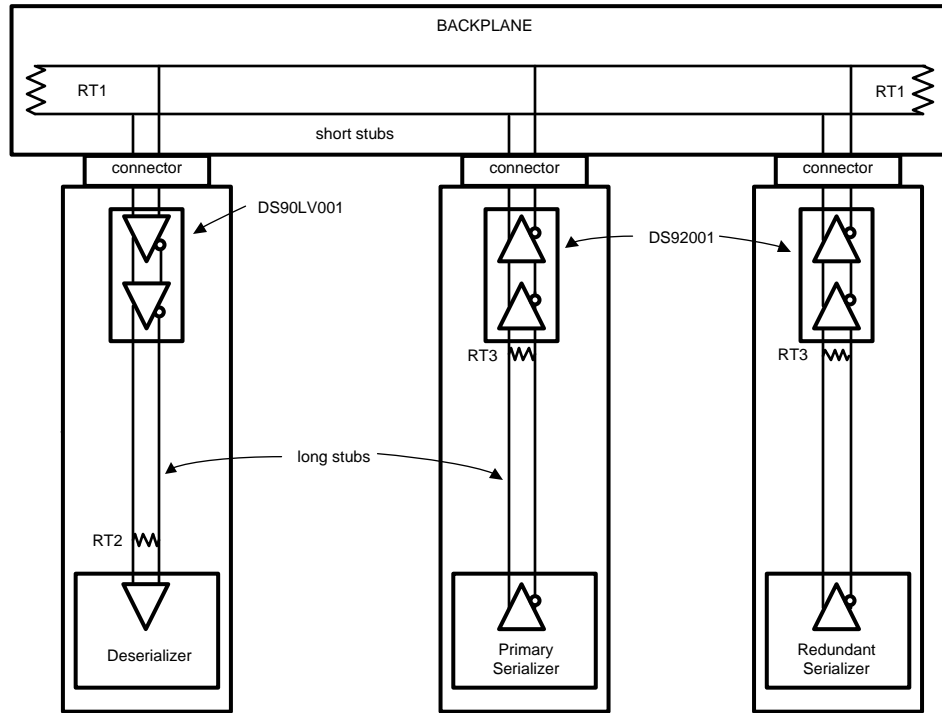

Figure 10. Backplane Stub-Hider Application

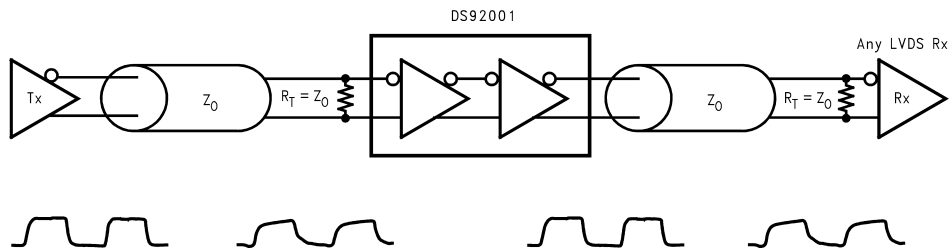

Figure 11. Cable Repeater Application

## APPLICATION INFORMATION

The DS92001 can be used as a "stub-hider." In many systems, signals are distributed across backplanes, and one of the limiting factors for system speed is the "stub length" or the distance between the transmission line and the unterminated receivers on the individual cards. See [Figure 10](#). Although it is generally recognized that this distance should be as short as possible to maximize system performance, real-world packaging concerns and PCB designs often make it difficult to make the stubs as short as the designer would like. The DS92001, available in the WSON package, can improve system performance by allowing the receiver to be placed very close to the main transmission line either on the backplane itself or very close to the connector on the card. Longer traces to the LVDS receiver may be placed after the DS92001. This very small WSON package is a 75% space savings over the SOIC package.

The DS92001 may also be used as a repeater as shown in [Figure 11](#). The signal is recovered and redriven at full strength down the following segment. The DS92001 may also be used as a level translator, as it accepts LVDS, BLVDS, and LVPECL inputs.

### POWER DECOUPLING RECOMMENDATIONS

Bypass capacitors must be used on power pins. Use high frequency ceramic (surface mount is recommended) 0.1 $\mu$ F and 0.01 $\mu$ F capacitors in parallel at the power supply pin with the smallest value capacitor closest to the device supply pin. Additional scattered capacitors over the printed circuit board will improve decoupling. Multiple vias should be used to connect the decoupling capacitors to the power planes. A 10 $\mu$ F (35V) or greater solid tantalum capacitor should be connected at the power entry point on the printed circuit board between the supply and ground.

### PC BOARD CONSIDERATIONS

Use at least 4 PCB board layers (top to bottom): LVDS signals, ground, power, TTL signals.

Isolate TTL signals from LVDS signals, otherwise the TTL signals may couple onto the LVDS lines. It is best to put TTL and LVDS signals on different layers which are isolated by a power/ground plane(s).

Keep drivers and receivers as close to the (LVDS port side) connectors as possible.

For PC board considerations for the WSON package, please refer to application note AN-1187 "Leadless Leadframe Package" (Literature Number SNOA401). It is important to note that to optimize signal integrity (minimize jitter and noise coupling), the WSON thermal land pad, which is a metal (normally copper) rectangular region located under the package as seen in [Figure 12](#), should be attached to ground and match the dimensions of the exposed pad on the PCB (1:1 ratio).

#### Top View

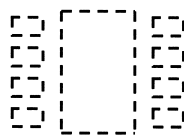

**Figure 12. WSON Thermal Land Pad and Pin Pads**

### DIFFERENTIAL TRACES

Use controlled impedance traces which match the differential impedance of your transmission medium (ie. cable) and termination resistor. Run the differential pair trace lines as close together as possible as soon as they leave the IC (stubs should be < 10mm long). This will help eliminate reflections and ensure noise is coupled as common-mode. In fact, we have seen that differential signals which are 1mm apart radiate far less noise than traces 3mm apart since magnetic field cancellation is much better with the closer traces. In addition, noise induced on the differential lines is much more likely to appear as common-mode which is rejected by the receiver.

Match electrical lengths between traces to reduce skew. Skew between the signals of a pair means a phase difference between signals which destroys the magnetic field cancellation benefits of differential signals and EMI will result. Do not rely solely on the auto-route function for differential traces. Carefully review dimensions to match differential impedance and provide isolation for the differential lines. Minimize the number of vias and other discontinuities on the line.

Avoid 90° turns (these cause impedance discontinuities). Use arcs or 45° bevels.

Within a pair of traces, the distance between the two traces should be minimized to maintain common-mode rejection of the receivers. On the printed circuit board, this distance should remain constant to avoid discontinuities in differential impedance. Minor violations at connection points are allowable.

## TERMINATION

Use a termination resistor which best matches the differential impedance or your transmission line. The resistor should be between 90Ω and 130Ω for point-to-point links. Multidrop (driver in the middle) or multipoint configurations are typically terminated at both ends. The termination value may be lower than 100Ω due to loading effects and in the 50Ω to 100Ω range. Remember that the current mode outputs need the termination resistor to generate the differential voltage.

Surface mount 1% - 2% resistors are the best. PCB stubs, component lead, and the distance from the termination to the receiver inputs should be minimized. The distance between the termination resistor and the receiver should be < 10mm (12mm MAX).

## PROBING LVDS TRANSMISSION LINES

Always use high impedance (> 100kΩ), low capacitance (< 2 pF) scope probes with a wide bandwidth (1 GHz) scope. Improper probing will give deceiving results.

## REVISION HISTORY

Changes from Revision E (April 2013) to Revision F	Page
• Changed layout of National Data Sheet to TI format .....	<a href="#">9</a>

**PACKAGING INFORMATION**

Orderable Device	Status (1)	Package Type	Package Drawing	Pins	Package Qty	Eco Plan (2)	Lead/Ball Finish (6)	MSL Peak Temp (3)	Op Temp (°C)	Device Marking (4/5)	Samples
DS92001TLD/NOPB	ACTIVE	WSON	NGK	8	1000	Green (RoHS & no Sb/Br)	CU SN	Level-3-260C-168 HR	-40 to 85	92001	<a href="#">Samples</a>
DS92001TMA/NOPB	ACTIVE	SOIC	D	8	95	Green (RoHS & no Sb/Br)	CU SN	Level-1-260C-UNLIM	-40 to 85	92001 TMA	<a href="#">Samples</a>
DS92001TMAX/NOPB	ACTIVE	SOIC	D	8	2500	Green (RoHS & no Sb/Br)	CU SN	Level-1-260C-UNLIM	-40 to 85	92001 TMA	<a href="#">Samples</a>

(1) The marketing status values are defined as follows:

**ACTIVE:** Product device recommended for new designs.

**LIFEBUY:** TI has announced that the device will be discontinued, and a lifetime-buy period is in effect.

**NRND:** Not recommended for new designs. Device is in production to support existing customers, but TI does not recommend using this part in a new design.

**PREVIEW:** Device has been announced but is not in production. Samples may or may not be available.

**OBsolete:** TI has discontinued the production of the device.

(2) Eco Plan - The planned eco-friendly classification: Pb-Free (RoHS), Pb-Free (RoHS Exempt), or Green (RoHS & no Sb/Br) - please check <http://www.ti.com/productcontent> for the latest availability information and additional product content details.

**TBD:** The Pb-Free/Green conversion plan has not been defined.

**Pb-Free (RoHS):** TI's terms "Lead-Free" or "Pb-Free" mean semiconductor products that are compatible with the current RoHS requirements for all 6 substances, including the requirement that lead not exceed 0.1% by weight in homogeneous materials. Where designed to be soldered at high temperatures, TI Pb-Free products are suitable for use in specified lead-free processes.

**Pb-Free (RoHS Exempt):** This component has a RoHS exemption for either 1) lead-based flip-chip solder bumps used between the die and package, or 2) lead-based die adhesive used between the die and leadframe. The component is otherwise considered Pb-Free (RoHS compatible) as defined above.

**Green (RoHS & no Sb/Br):** TI defines "Green" to mean Pb-Free (RoHS compatible), and free of Bromine (Br) and Antimony (Sb) based flame retardants (Br or Sb do not exceed 0.1% by weight in homogeneous material)

(3) MSL, Peak Temp. - The Moisture Sensitivity Level rating according to the JEDEC industry standard classifications, and peak solder temperature.

(4) There may be additional marking, which relates to the logo, the lot trace code information, or the environmental category on the device.

(5) Multiple Device Markings will be inside parentheses. Only one Device Marking contained in parentheses and separated by a "~" will appear on a device. If a line is indented then it is a continuation of the previous line and the two combined represent the entire Device Marking for that device.

(6) Lead/Ball Finish - Orderable Devices may have multiple material finish options. Finish options are separated by a vertical ruled line. Lead/Ball Finish values may wrap to two lines if the finish value exceeds the maximum column width.

**Important Information and Disclaimer:** The information provided on this page represents TI's knowledge and belief as of the date that it is provided. TI bases its knowledge and belief on information provided by third parties, and makes no representation or warranty as to the accuracy of such information. Efforts are underway to better integrate information from third parties. TI has taken and

continues to take reasonable steps to provide representative and accurate information but may not have conducted destructive testing or chemical analysis on incoming materials and chemicals. TI and TI suppliers consider certain information to be proprietary, and thus CAS numbers and other limited information may not be available for release.

In no event shall TI's liability arising out of such information exceed the total purchase price of the TI part(s) at issue in this document sold by TI to Customer on an annual basis.

## TAPE AND REEL INFORMATION

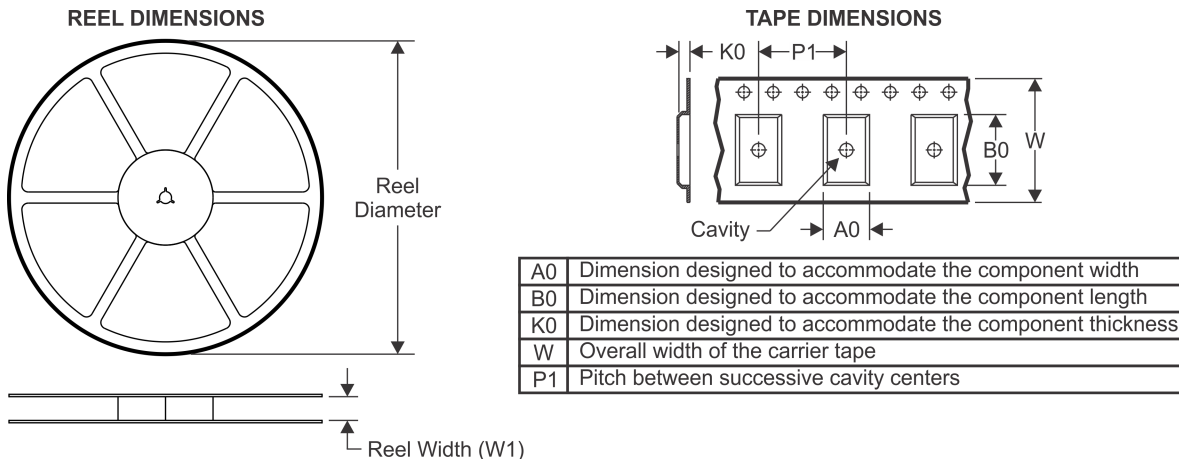

### QUADRANT ASSIGNMENTS FOR PIN 1 ORIENTATION IN TAPE

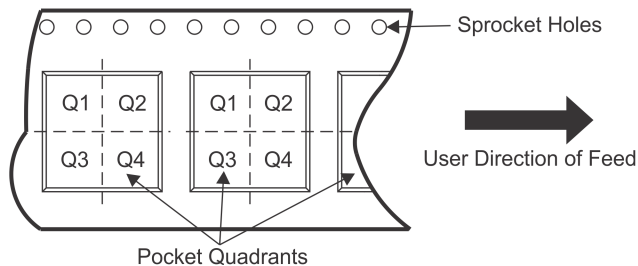

\*All dimensions are nominal

Device	Package Type	Package Drawing	Pins	SPQ	Reel Diameter (mm)	Reel Width W1 (mm)	A0 (mm)	B0 (mm)	K0 (mm)	P1 (mm)	W (mm)	Pin1 Quadrant
DS92001TLD/NOPB	WSON	NGK	8	1000	178.0	12.4	3.3	3.3	1.0	8.0	12.0	Q1
DS92001TMAX/NOPB	SOIC	D	8	2500	330.0	12.4	6.5	5.4	2.0	8.0	12.0	Q1

**TAPE AND REEL BOX DIMENSIONS**



\*All dimensions are nominal

Device	Package Type	Package Drawing	Pins	SPQ	Length (mm)	Width (mm)	Height (mm)
DS92001TLD/NOPB	WSON	NGK	8	1000	213.0	191.0	55.0
DS92001TMAX/NOPB	SOIC	D	8	2500	367.0	367.0	35.0

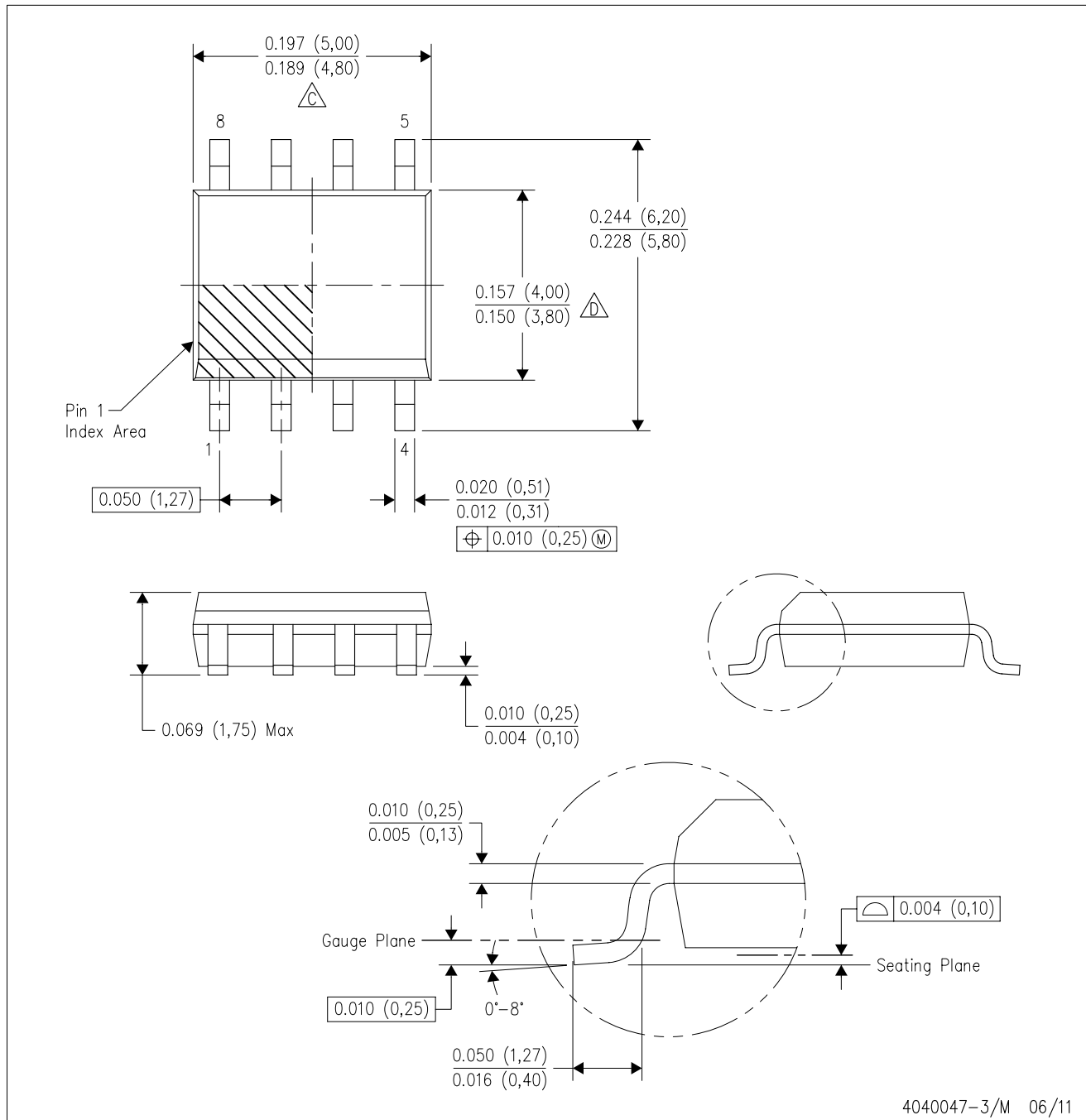

D (R-PDSO-G8)

PLASTIC SMALL OUTLINE



- NOTES:
- A. All linear dimensions are in inches (millimeters).
  - B. This drawing is subject to change without notice.
  - C. Body length does not include mold flash, protrusions, or gate burrs. Mold flash, protrusions, or gate burrs shall not exceed 0.006 (0,15) each side.
  - D. Body width does not include interlead flash. Interlead flash shall not exceed 0.017 (0,43) each side.
  - E. Reference JEDEC MS-012 variation AA.

## IMPORTANT NOTICE

Texas Instruments Incorporated and its subsidiaries (TI) reserve the right to make corrections, enhancements, improvements and other changes to its semiconductor products and services per JESD46, latest issue, and to discontinue any product or service per JESD48, latest issue. Buyers should obtain the latest relevant information before placing orders and should verify that such information is current and complete. All semiconductor products (also referred to herein as "components") are sold subject to TI's terms and conditions of sale supplied at the time of order acknowledgment.

TI warrants performance of its components to the specifications applicable at the time of sale, in accordance with the warranty in TI's terms and conditions of sale of semiconductor products. Testing and other quality control techniques are used to the extent TI deems necessary to support this warranty. Except where mandated by applicable law, testing of all parameters of each component is not necessarily performed.

TI assumes no liability for applications assistance or the design of Buyers' products. Buyers are responsible for their products and applications using TI components. To minimize the risks associated with Buyers' products and applications, Buyers should provide adequate design and operating safeguards.

TI does not warrant or represent that any license, either express or implied, is granted under any patent right, copyright, mask work right, or other intellectual property right relating to any combination, machine, or process in which TI components or services are used. Information published by TI regarding third-party products or services does not constitute a license to use such products or services or a warranty or endorsement thereof. Use of such information may require a license from a third party under the patents or other intellectual property of the third party, or a license from TI under the patents or other intellectual property of TI.

Reproduction of significant portions of TI information in TI data books or data sheets is permissible only if reproduction is without alteration and is accompanied by all associated warranties, conditions, limitations, and notices. TI is not responsible or liable for such altered documentation. Information of third parties may be subject to additional restrictions.

Resale of TI components or services with statements different from or beyond the parameters stated by TI for that component or service voids all express and any implied warranties for the associated TI component or service and is an unfair and deceptive business practice. TI is not responsible or liable for any such statements.

Buyer acknowledges and agrees that it is solely responsible for compliance with all legal, regulatory and safety-related requirements concerning its products, and any use of TI components in its applications, notwithstanding any applications-related information or support that may be provided by TI. Buyer represents and agrees that it has all the necessary expertise to create and implement safeguards which anticipate dangerous consequences of failures, monitor failures and their consequences, lessen the likelihood of failures that might cause harm and take appropriate remedial actions. Buyer will fully indemnify TI and its representatives against any damages arising out of the use of any TI components in safety-critical applications.

In some cases, TI components may be promoted specifically to facilitate safety-related applications. With such components, TI's goal is to help enable customers to design and create their own end-product solutions that meet applicable functional safety standards and requirements. Nonetheless, such components are subject to these terms.

No TI components are authorized for use in FDA Class III (or similar life-critical medical equipment) unless authorized officers of the parties have executed a special agreement specifically governing such use.

Only those TI components which TI has specifically designated as military grade or "enhanced plastic" are designed and intended for use in military/aerospace applications or environments. Buyer acknowledges and agrees that any military or aerospace use of TI components which have **not** been so designated is solely at the Buyer's risk, and that Buyer is solely responsible for compliance with all legal and regulatory requirements in connection with such use.

TI has specifically designated certain components as meeting ISO/TS16949 requirements, mainly for automotive use. In any case of use of non-designated products, TI will not be responsible for any failure to meet ISO/TS16949.

### Products

Audio	<a href="http://www.ti.com/audio">www.ti.com/audio</a>
Amplifiers	<a href="http://amplifier.ti.com">amplifier.ti.com</a>
Data Converters	<a href="http://dataconverter.ti.com">dataconverter.ti.com</a>
DLP® Products	<a href="http://www.dlp.com">www.dlp.com</a>
DSP	<a href="http://dsp.ti.com">dsp.ti.com</a>
Clocks and Timers	<a href="http://www.ti.com/clocks">www.ti.com/clocks</a>
Interface	<a href="http://interface.ti.com">interface.ti.com</a>
Logic	<a href="http://logic.ti.com">logic.ti.com</a>
Power Mgmt	<a href="http://power.ti.com">power.ti.com</a>
Microcontrollers	<a href="http://microcontroller.ti.com">microcontroller.ti.com</a>
RFID	<a href="http://www.ti-rfid.com">www.ti-rfid.com</a>
OMAP Applications Processors	<a href="http://www.ti.com/omap">www.ti.com/omap</a>
Wireless Connectivity	<a href="http://www.ti.com/wirelessconnectivity">www.ti.com/wirelessconnectivity</a>

### Applications

Automotive and Transportation	<a href="http://www.ti.com/automotive">www.ti.com/automotive</a>
Communications and Telecom	<a href="http://www.ti.com/communications">www.ti.com/communications</a>
Computers and Peripherals	<a href="http://www.ti.com/computers">www.ti.com/computers</a>
Consumer Electronics	<a href="http://www.ti.com/consumer-apps">www.ti.com/consumer-apps</a>
Energy and Lighting	<a href="http://www.ti.com/energy">www.ti.com/energy</a>
Industrial	<a href="http://www.ti.com/industrial">www.ti.com/industrial</a>
Medical	<a href="http://www.ti.com/medical">www.ti.com/medical</a>
Security	<a href="http://www.ti.com/security">www.ti.com/security</a>
Space, Avionics and Defense	<a href="http://www.ti.com/space-avionics-defense">www.ti.com/space-avionics-defense</a>
Video and Imaging	<a href="http://www.ti.com/video">www.ti.com/video</a>

### TI E2E Community

[e2e.ti.com](http://e2e.ti.com)