

Dual 150mA Ultra Low-Dropout Regulator

Check for Samples: [LP2966](#)

FEATURES

- Ultra Low Drop-Out Voltage
- Low Ground Pin Current
- $1\mu\text{A}$ Quiescent Current in Shutdown Mode
- Independent Shutdown of Each LDO Regulator
- Output Voltage Accuracy $\pm 1\%$
- Ensured 150mA Output Current at Each Output
- Low Output Noise
- Error Flags Indicate Status of Each Output
- Available in VSSOP-8 Surface Mount Package
- Low Output Capacitor Requirements (1 μF)
- Operates with Low ESR Ceramic Capacitors in Most Applications
- Over Temperature/Over Current Protection
- -40°C to $+125^{\circ}\text{C}$ Junction Temperature Range

APPLICATIONS

- Cellular and Wireless Applications
- Palmtop/Laptop Computer
- GPS Systems
- Flat Panel Displays
- Post Regulators
- USB Applications
- Hand Held Equipment and Multimeters
- Wireless Data Terminals
- Other Battery Powered Applications

KEY SPECIFICATIONS

- **Dropout Voltage: Varies Linearly with Load Current.** Typically 0.9 mV at 1mA Load Current and 135mV at 150mA Load Current
- **Ground Pin Current: Typically 300 μA at 1mA Load Current and 340 μA at 100mA Load Current (with One Shutdown Pin Pulled Low)**
- **Shutdown Mode: Less than 1 μA Quiescent Current when Both Shutdown Pins are Pulled Low**
- **Error Flag: Open Drain Output, Goes Low when the Corresponding Output Drops 10% Below Nominal**
- **Precision Output Voltage: Multiple Output Voltage Options Available Ranging from 1.8V to 5.0V with an Ensured Accuracy of $\pm 1\%$ at Room Temperature**

DESCRIPTION

The LP2966 dual ultra low-dropout (LDO) regulator operates from a +2.70V to +7.0V input supply. Each output delivers 150mA over full temperature range. The IC operates with extremely low drop-out voltage and quiescent current, which makes it very suitable for battery powered and portable applications. Each LDO in the LP2966 has independent shutdown capability. The LP2966 provides low noise performance with low ground pin current in an extremely small VSSOP-8 package (refer to package dimensions and [CONNECTION DIAGRAM](#) for more information on VSSOP-8 package). A wide range of preset voltage options are available for each output. In addition, many more are available upon request with minimum orders. In all, 256 voltage combinations are possible.



Please be aware that an important notice concerning availability, standard warranty, and use in critical applications of Texas Instruments semiconductor products and disclaimers thereto appears at the end of this data sheet.

All trademarks are the property of their respective owners.

TYPICAL APPLICATION CIRCUIT

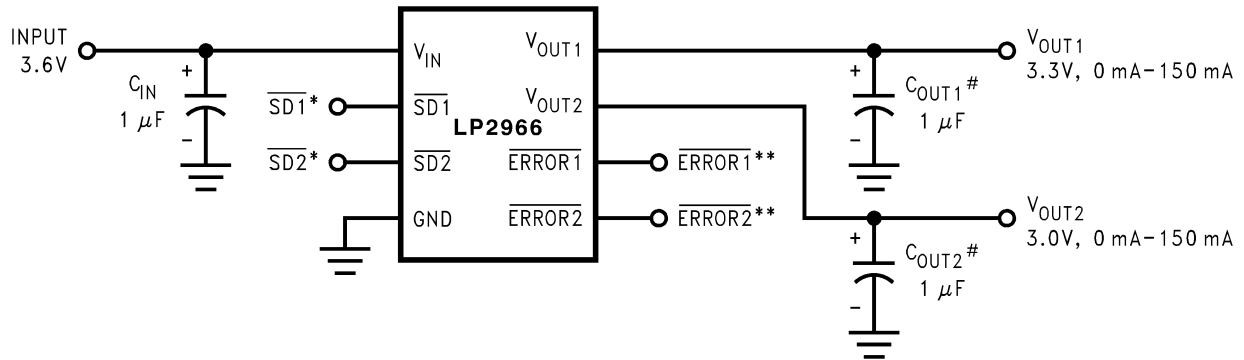

*SD1 and SD2 must be actively terminated through a pull up resistor. Tie to V_{IN} if not used.

**ERROR1 and ERROR2 are open drain outputs. These pins must be connected to ground if not used.

Minimum output capacitance is 1μF to insure stability over full load current range. More capacitance improves superior dynamic performance and provides additional stability margin.

BLOCK DIAGRAM

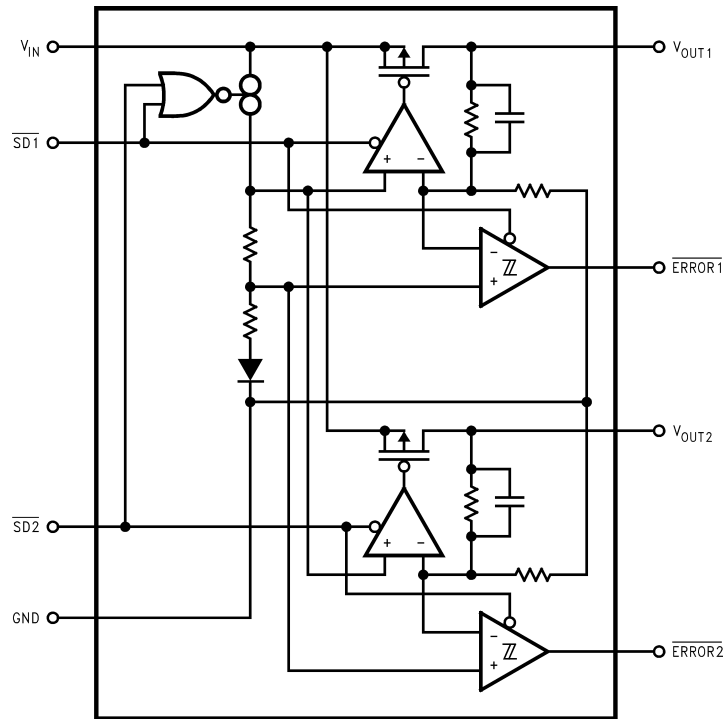

CONNECTION DIAGRAM

Top View

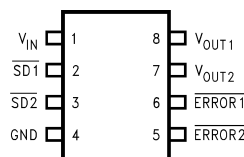

**Figure 1. VSSOP-8 Package
8-Lead Small Outline Integrated Circuit
See Package Number DGK0008A**

PIN DESCRIPTIONS

Pin	Name	Function
1	VIN	Input Supply pin
2	$\overline{SD1}$	Active low shutdown pin for output 1
3	$\overline{SD2}$	Active low shutdown pin for output 2
4	GND	Ground
5	$\overline{ERROR2}$	Error flag for output 2 - Normally high impedance, should be connected to ground if not used.
6	$\overline{ERROR1}$	Error flag for output 1 - Normally high impedance, should be connected to ground if not used.
7	VOUT2	Output 2
8	VOUT1	Output 1



These devices have limited built-in ESD protection. The leads should be shorted together or the device placed in conductive foam during storage or handling to prevent electrostatic damage to the MOS gates.

ABSOLUTE MAXIMUM RATINGS⁽¹⁾⁽²⁾

Storage Temperature Range	-65 to +150°C
Lead Temp. (Soldering, 5 sec.)	260°C
Power Dissipation ⁽³⁾	Internally Limited
ESD Rating ⁽⁴⁾	2kV
Input Supply Voltage (Survival)	-0.3V to 7.5V
Shutdown Input Voltage (Survival)	-0.3V to (VIN + 0.3V)
Maximum Voltage for \overline{ERROR} Pins	10V
I _{OUT} (Survival)	Short Circuit Protected
Output Voltage (Survival) ⁽⁵⁾⁽⁶⁾	-0.3V to (VIN + 0.3V)

- (1) Absolute Maximum Ratings indicate limits beyond which damage to the device may occur. Operating ratings indicate conditions for which the device is intended to be functional, but do not ensure specific performance limits. For ensured specifications and test conditions, see [ELECTRICAL CHARACTERISTICS](#). The ensured specifications apply only for the test conditions listed. Some performance characteristics may degrade when the device is not operated under the listed test conditions.
- (2) If Military/Aerospace specified devices are required, please contact the Texas Instruments Sales Office/ Distributors for availability and specifications.
- (3) At elevated temperatures, devices must be derated based on package thermal resistance. The device in the surface-mount package must be derated at $\theta_{JA} = 235^{\circ}\text{C}/\text{W}$, junction-to-ambient. Please refer to [APPLICATIONS INFORMATION](#): Maximum Current Capability for further information. The device has internal thermal protection.
- (4) The human body model is a 100pF capacitor discharged through a 1.5k Ω resistor into each pin.
- (5) If used in a dual-supply system where the regulator load is returned to a negative supply, the LP2966 output must be diode-clamped to ground.
- (6) The output PMOS structure contains a diode between the V_{IN} and V_{OUT} terminals that is normally reverse-biased. Reversing the polarity from V_{IN} and V_{OUT} will turn on this diode.

OPERATING RATINGS⁽¹⁾

Input Supply Voltage	2.7V to 7.0V
Shutdown Input Voltage	-0.3V to (VIN + 0.3V)
Operating Junction Temperature Range	-40°C to +125°C
Maximum Voltage for \overline{ERROR} pins	10V

- (1) Absolute Maximum Ratings indicate limits beyond which damage to the device may occur. Operating ratings indicate conditions for which the device is intended to be functional, but do not ensure specific performance limits. For ensured specifications and test conditions, see [ELECTRICAL CHARACTERISTICS](#). The ensured specifications apply only for the test conditions listed. Some performance characteristics may degrade when the device is not operated under the listed test conditions.

ELECTRICAL CHARACTERISTICS

Limits in standard typeface are for $T_j = 25^\circ\text{C}$, and limits in **boldface type** apply over the full operating junction temperature range. Unless otherwise specified, $V_{IN} = V_{O(NOM)} + 1\text{V}^{(1)}$, $C_{OUT} = 1\mu\text{F}$, $I_{OUT} = 1\text{mA}$, $C_{IN} = 1\mu\text{F}$, $V_{SD1} = V_{SD2} = V_{IN}$.

Symbol	Parameter	Conditions	Typ ⁽²⁾	LP2966IMM ⁽³⁾		Unit
				Min	Max	
$V_o^{(4)}$	Output Voltage Tolerance	$V_{OUT} + 1\text{V} < V_{IN} < 7.0\text{V}$	0.0	-1	1	% V_{NOM}
		$1\text{mA} < I_L < 100\text{mA}$	0.0	-3	3	% V_{NOM}
$\Delta V_o / \Delta V_{IN}^{(4)(5)}$	Output Voltage Line Regulation		0.1			mV/V
$\Delta V_o / \Delta I_{OUT}$	Output Voltage Load Regulation ⁽⁶⁾	$1\text{mA} < I_L < 100\text{mA}^{(6)}$	0.1			mV/mA
$\Delta V_{O2} / \Delta I_{OUT1}$	Output Voltage Cross Regulation ⁽⁷⁾	$1\text{mA} < I_{L1} < 100\text{mA}^{(7)}$	0.0004			mV/mA
$V_{IN} - V_{OUT}$	Dropout Voltage ⁽⁸⁾	$I_L = 1\text{mA}$	0.9		2.0 3.0	mV
		$I_L = 100\text{mA}$	90		130 180	
		$I_L = 150\text{mA}$	135		195 270	
$I_{GND(1,0)}^{(9)}$	Ground Pin Current (One LDO On)	$I_L = 1\text{mA}$ $V_{SD2} \leq 0.1\text{V}$, $V_{SD1} = V_{IN}$	300			μA
		$I_L = 100\text{mA}$ $V_{SD2} \leq 0.1\text{V}$, $V_{SD1} = V_{IN}$	340			
$I_{GND(1,1)}$	Ground Pin Current (Both LDOs On)	$I_L = 1\text{mA}$	340		450 500	μA
		$I_L = 100\text{mA}$	420		540 600	
$I_{GND(0,0)}$	Ground Pin Current in Shutdown Mode	$V_{SD1} = V_{SD2} \leq 0.1\text{V}$	0.006		0.3 10	μA
$I_{O(PK)}$	Peak Output Current	See ⁽¹⁰⁾ $V_{OUT} \geq V_{OUT(NOM)} - 5\%$	500	350 150		mA
Short Circuit Foldback Protection						
I_{FB}	Short Circuit Foldback Knee	See ⁽¹⁰⁾⁽¹¹⁾	600			mA

- (1) The condition $V_{IN} = V_{O(NOM)} + 1\text{V}$ applies when $V_{out1} = V_{out2}$. If $V_{out1} \neq V_{out2}$, then this condition would apply to the output which is greater in value. As an example, if $V_{out1} = 3.3\text{V}$ and $V_{out2} = 5\text{V}$, then the condition $V_{IN} = V_{O(NOM)} + 1\text{V}$ would apply to V_{out2} only.
- (2) :Typical numbers are at 25°C and represent the most likely parametric norm.
- (3) :Limits are 100% production tested at 25°C . Limits over the operating temperature range are ensured through correlation using Statistical Quality Control (SQC) methods. The limits are used to calculate Averaging Outgoing Quality Level (AOQL).
- (4) Output voltage tolerance specification also includes the line regulation and load regulation.
- (5) Output voltage line regulation is defined as the change in output voltage from the nominal value due to change in input line voltage.
- (6) Output voltage load regulation is defined as the change in output voltage from the nominal value when the load current changes from 1mA to 100mA.
- (7) Output voltage cross regulation is defined as the percentage change in the output voltage from the nominal value at one output when the load current changes from 1mA to full load in the other output. This is an important parameter in multiple output regulators. The specification for $\Delta V_{O1} / \Delta I_{OUT2}$ is equal to the specification for $\Delta V_{O2} / \Delta I_{OUT1}$.
- (8) Dropout voltage is defined as the input to output differential at which the output voltage drops 100mV below the nominal value. Drop-out voltage specification applies only to output voltages greater than 2.7V. For output voltages below 2.7V, the drop-out voltage is nothing but the input to output differential, since the minimum input voltage is 2.7V.
- (9) The limits for the ground pin current specification, $I_{GND(0,1)}$ will be same as the limits for the specification, $I_{GND(1,0)}$.
- (10) At elevated temperatures, devices must be derated based on package thermal resistance. The device in the surface-mount package must be derated at $\theta_{JA} = 235^\circ\text{C/W}$, junction-to-ambient. Please refer to [APPLICATIONS INFORMATION: Maximum Current Capability](#) for further information. The device has internal thermal protection.
- (11) LP2966 has fold back current limited short circuit protection. The knee is the current at which the output voltage drops 10% below the nominal value.

ELECTRICAL CHARACTERISTICS (continued)

Limits in standard typeface are for $T_j = 25^\circ\text{C}$, and limits in **boldface type** apply over the full operating junction temperature range. Unless otherwise specified, $V_{IN} = V_{O(NOM)} + 1\text{V}^{(1)}$, $C_{OUT} = 1\mu\text{F}$, $I_{OUT} = 1\text{mA}$, $C_{IN} = 1\mu\text{F}$, $V_{SD1} = V_{SD2} = V_{IN}$.

Symbol	Parameter	Conditions	Typ ⁽²⁾	LP2966IMM ⁽³⁾		Unit
				Min	Max	
Over Temperature Protection						
Tsh(t)	Shutdown Threshold		165			°C
Tsh(h)	Thermal Shutdown Hysteresis		25			°C
Shutdown Input						
V _{SDT}	Shutdown Threshold ⁽¹²⁾	Output = Low	0		0.1	V
		Output = High	V _{IN}	V_{IN} - 0.1		
T _{dOFF}	Turn-off Delay ⁽¹³⁾	I _L = 100 mA	20			μsec
T _{dON}	Turn-on Delay ⁽¹³⁾	I _L = 100 mA	25			μsec
I _{SD}	SD Input Current	V _{SD} = V _{IN}	1			nA
		V _{SD} = 0 V	1			
Error Flag Comparators						
V _T	Threshold (output goes high to low)	See ⁽¹⁴⁾	10	5	16	%
V _{TH}	Threshold Hysteresis	See ⁽¹⁴⁾	5	2	8	%
V _{ERR(Sat)}	Error Flag Saturation	I _{Fsink} = 100μA	0.015		0.1	V
I _{EF(leak)}	Error Flag Pin Leakage Current		1			nA
I _(EFsink)	Error Flag Pin Sink Current		1			mA
AC Parameters						
PSRR	Ripple Rejection	V _{IN} = V _{OUT} + 1V, f = 120Hz, V _{OUT} = 3.3V	60			dB
		V _{IN} = V _{OUT} + 0.3V, f = 120Hz, V _{OUT} = 3.3V	40			
pn(1/f)	Output Noise Density	f = 120Hz	1			μV/√Hz
e _n	Output Noise Voltage (rms)	BW = 10Hz – 100kHz, C _{OUT} = 10μF	150			μV(rms)
		BW = 300Hz – 300kHz, C _{OUT} = 10μF	100			

(12) V_{SDT} is the shutdown pin voltage threshold below which the output is disabled.

(13) Turn-on delay is the time interval between the low to high transition on the shutdown pin to the output voltage settling to within 5% of the nominal value. Turn-off delay is the time interval between the high to low transition on the shutdown pin to the output voltage dropping below 50% of the nominal value. The external load impedance influences the output voltage decay in shutdown mode.

(14) Error Flag threshold and hysteresis are specified as the percentage below the regulated output voltage.

TYPICAL PERFORMANCE CHARACTERISTICS

Unless otherwise specified, $V_{IN} = V_{O(NOM)} + 1V$, $V_{OUT} = 3.3V$, $C_{OUT} = 1\mu F$, $I_{OUT} = 1mA$, $C_{IN} = 1\mu F$, $V_{SD1} = V_{SD2} = V_{IN}$, and $T_A = 25^\circ C$.

Ground Pin Current vs Supply Voltage (one LDO on)

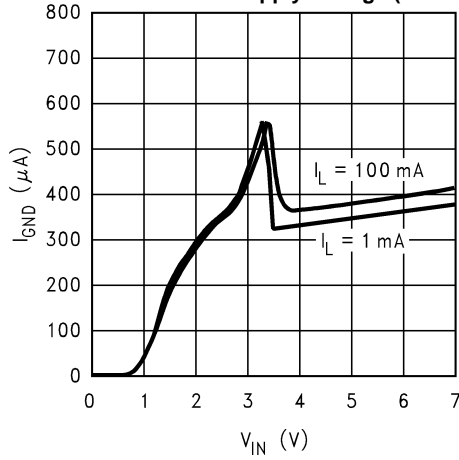

Figure 2.

Ground Pin Current vs Supply Voltage (both LDOs on)

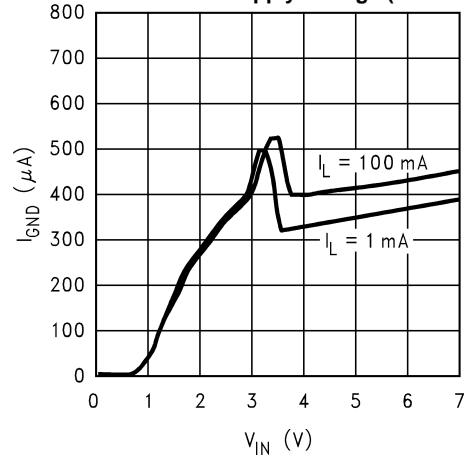

Figure 3.

Ground Pin Current vs Load Current over temperature (one LDO on)

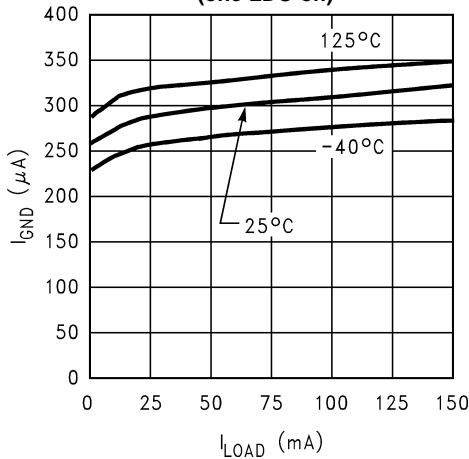

Figure 4.

Ground Pin Current vs Load Current over temperature (both LDOs on)

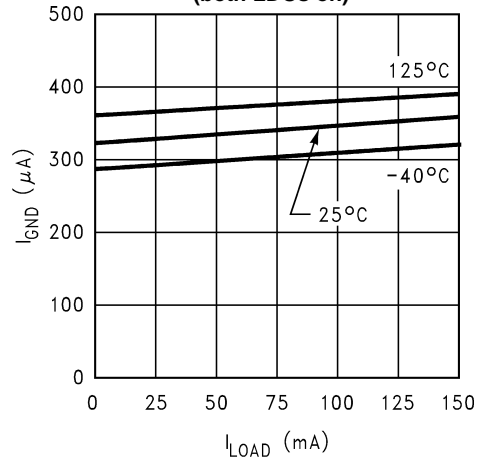

Figure 5.

Output Voltage vs Temperature

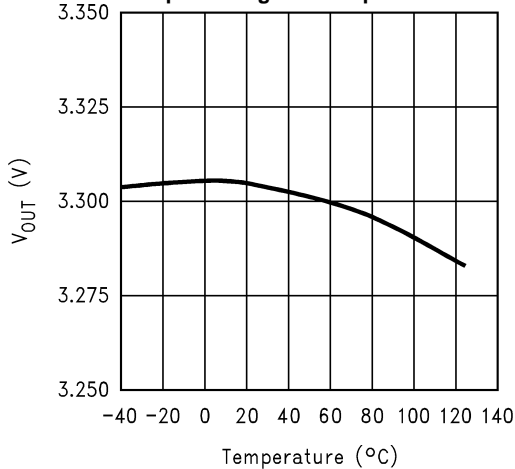

Figure 6.

Drop-out Voltage vs Temperature

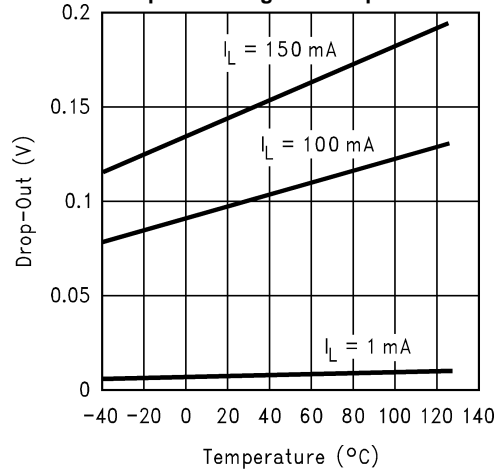

Figure 7.

TYPICAL PERFORMANCE CHARACTERISTICS (continued)

Unless otherwise specified, $V_{IN} = V_{O(NOM)} + 1V$, $V_{OUT} = 3.3V$, $C_{OUT} = 1\mu F$, $I_{OUT} = 1mA$, $C_{IN} = 1\mu F$, $V_{SD1} = V_{SD2} = V_{IN}$, and $T_A = 25^\circ C$.

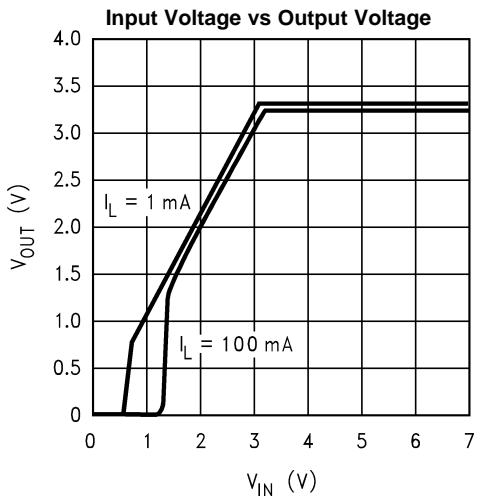

Figure 8.

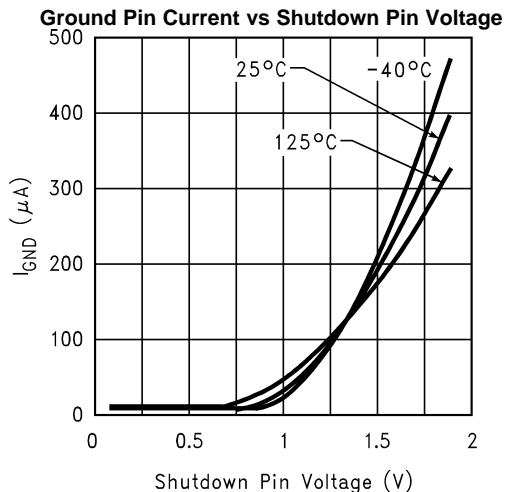

Figure 9.

Ground Pin Current vs Input Voltage (Both LDOs off)

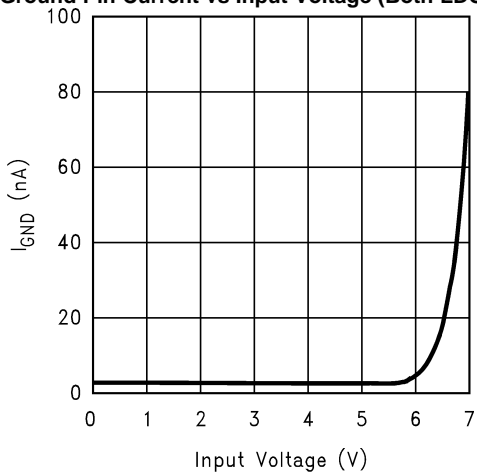

Figure 10.

Short-Circuit Foldback Protection

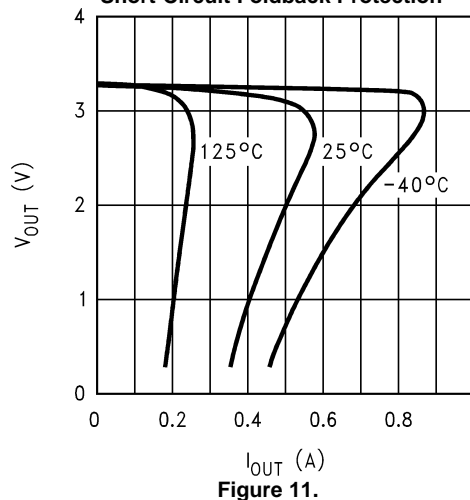

Figure 11.

Line Transient Response
($C_{OUT} = 2.2\mu F$, $I_{OUT} = 1mA$)

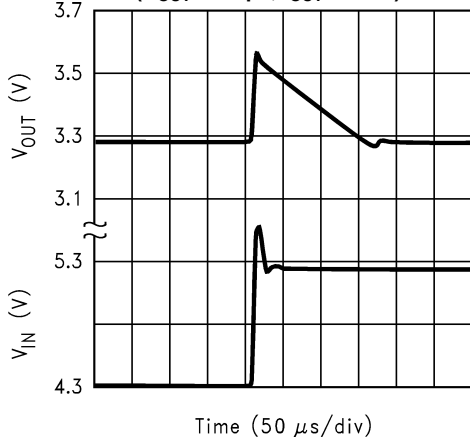

Figure 12.

Line Transient Response
($C_{OUT} = 2.2\mu F$, $I_{OUT} = 1mA$)

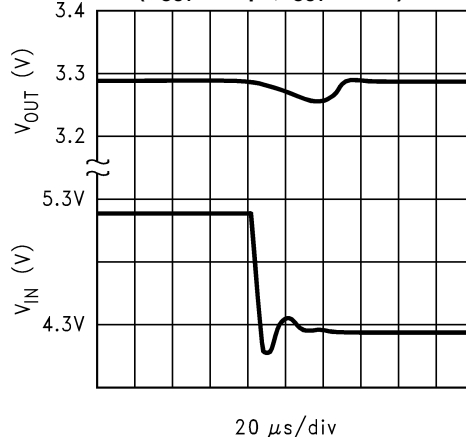
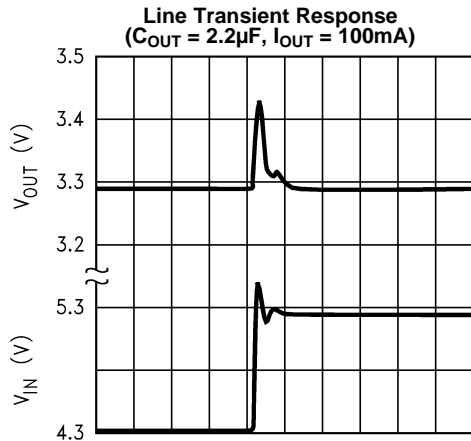

Figure 13.

TYPICAL PERFORMANCE CHARACTERISTICS (continued)

Unless otherwise specified, $V_{IN} = V_{O(NOM)} + 1V$, $V_{OUT} = 3.3V$, $C_{OUT} = 1\mu F$, $I_{OUT} = 1mA$, $C_{IN} = 1\mu F$, $V_{SD1} = V_{SD2} = V_{IN}$, and $T_A = 25^\circ C$.



50 μs /div
Figure 14.

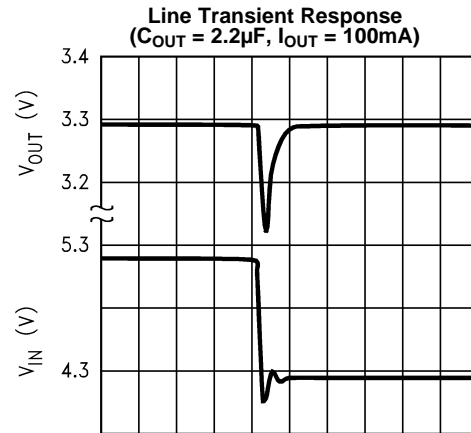

50 μs /div
Figure 15.

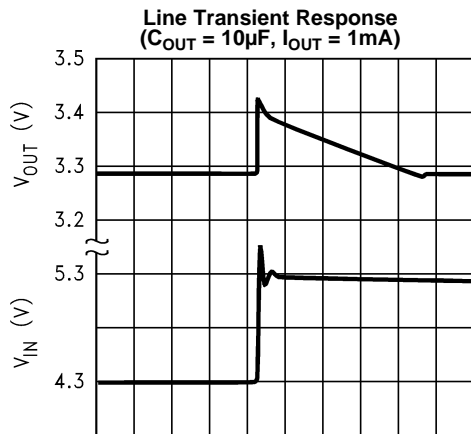

100 μs /div
Figure 16.

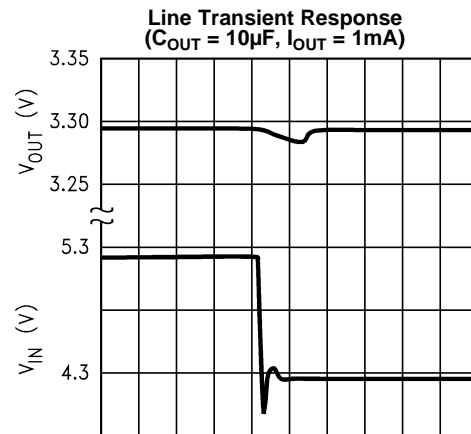

50 μs /div
Figure 17.

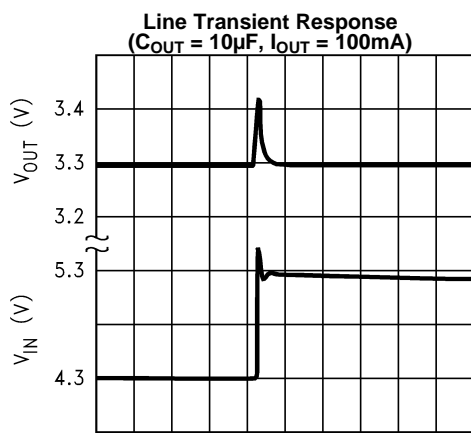

100 μs /div
Figure 18.

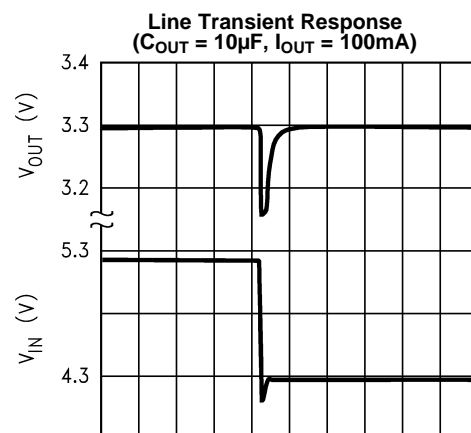

100 μs /div
Figure 19.

TYPICAL PERFORMANCE CHARACTERISTICS (continued)

Unless otherwise specified, $V_{IN} = V_{O(NOM)} + 1V$, $V_{OUT} = 3.3V$, $C_{OUT} = 1\mu F$, $I_{OUT} = 1mA$, $C_{IN} = 1\mu F$, $V_{SD1} = V_{SD2} = V_{IN}$, and $T_A = 25^\circ C$.

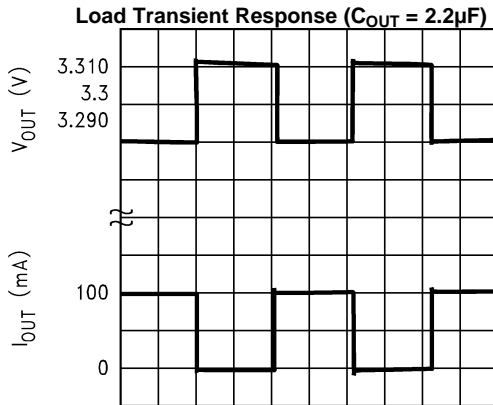

10 ms/div
Figure 20.

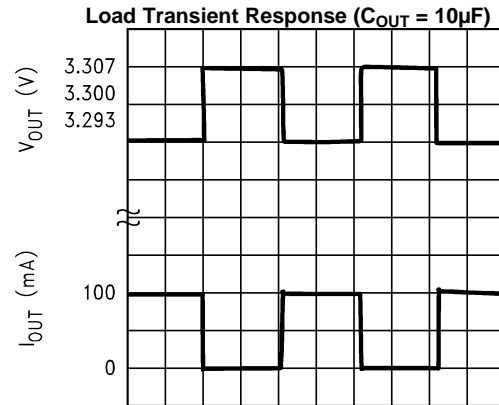

10 ms/div
Figure 21.

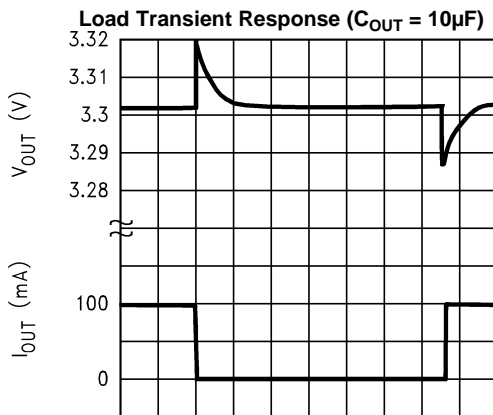

500 ms/div
Figure 22.

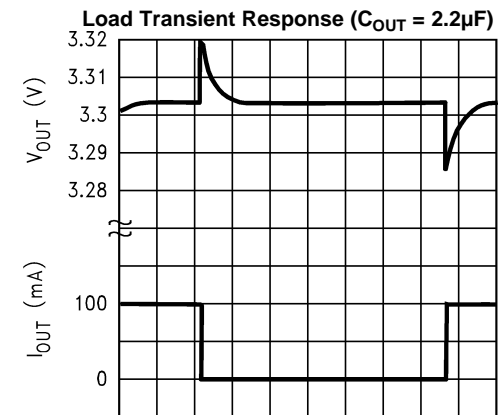

500 ms/div
Figure 23.

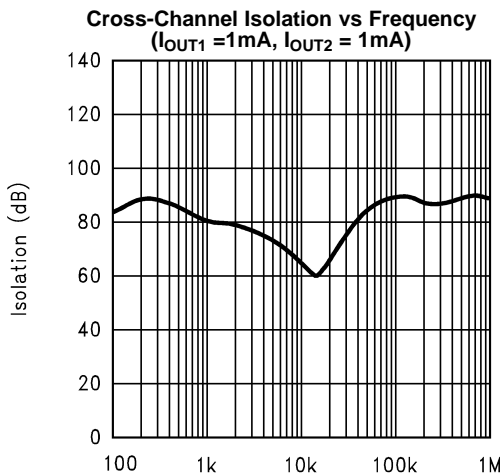

Frequency (Hz)
Figure 24.

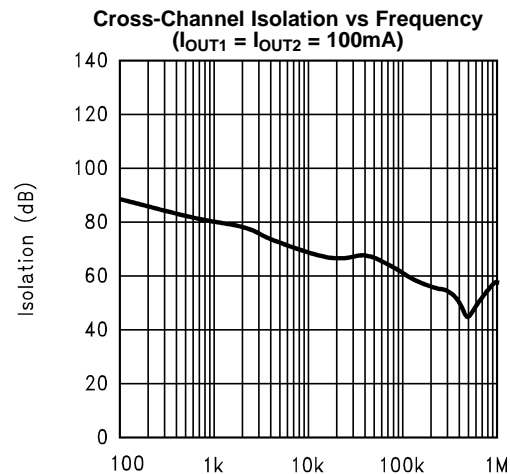

Frequency (Hz)
Figure 25.

TYPICAL PERFORMANCE CHARACTERISTICS (continued)

Unless otherwise specified, $V_{IN} = V_{O(NOM)} + 1V$, $V_{OUT} = 3.3V$, $C_{OUT} = 1\mu F$, $I_{OUT} = 1mA$, $C_{IN} = 1\mu F$, $V_{SD1} = V_{SD2} = V_{IN}$, and $T_A = 25^\circ C$.

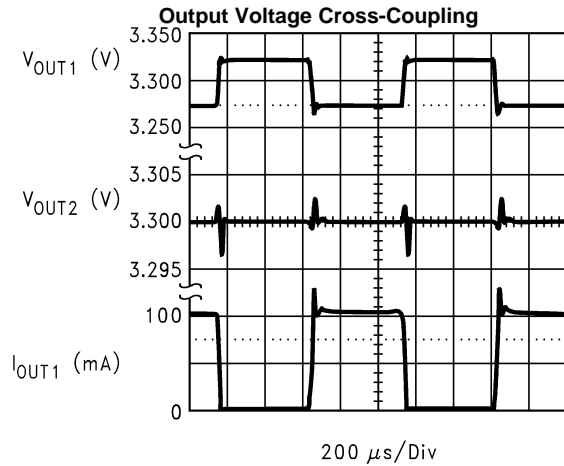

Figure 26.

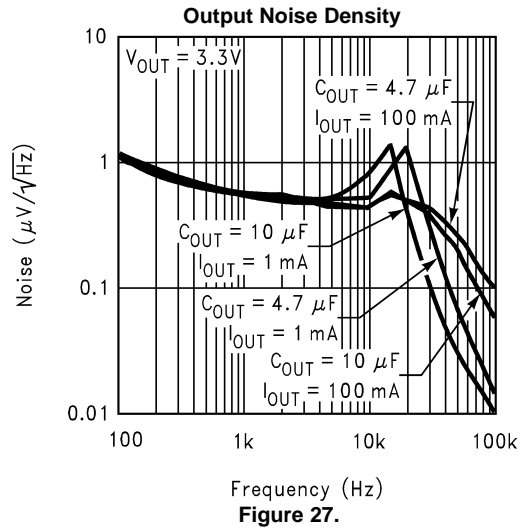

Figure 27.

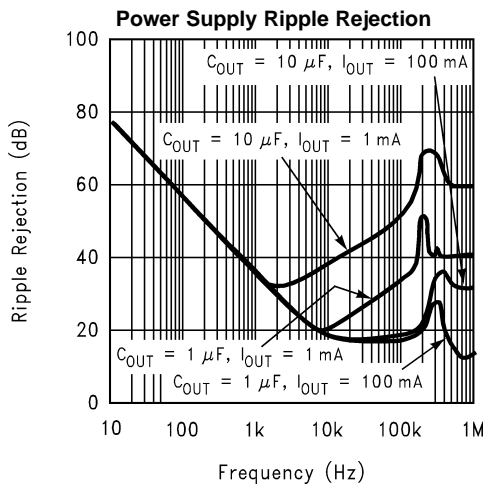

Figure 28.

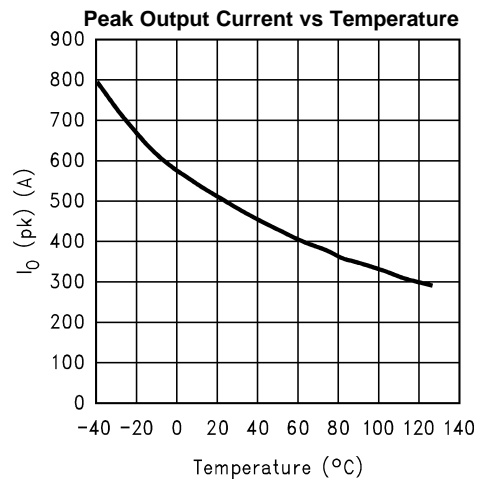

Figure 29.

APPLICATIONS INFORMATION

Input Capacitor Selection

LP2966 requires a minimum input capacitance of $1\mu\text{F}$ between the input and ground pins to prevent any impedance interactions with the supply. This capacitor should be located very close to the input pin. This capacitor can be of any type such as ceramic, tantalum, or aluminium. Any good quality capacitor which has good tolerance over temperature and frequency is recommended.

Output Capacitor Selection

The LP2966 requires a minimum of $1\mu\text{F}$ capacitance on each output for proper operation. To insure stability, this capacitor should maintain its ESR (equivalent series resistance) in the stable region of the ESR curves (Figure 30 and Figure 31) over the full operating temperature range of the application. The output capacitor should have a good tolerance over temperature, voltage, and frequency. The output capacitor can be increased without limit. Larger capacitance provides better stability and noise performance. The output capacitor should be connected very close to the Vout pin of the IC.

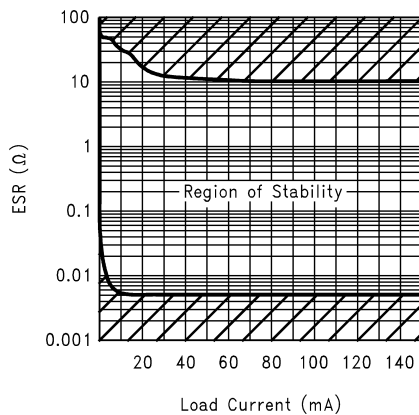

Figure 30. ESR Curve for $V_{\text{OUT}} = 5\text{V}$ and $C_{\text{OUT}} = 2.2\mu\text{F}$

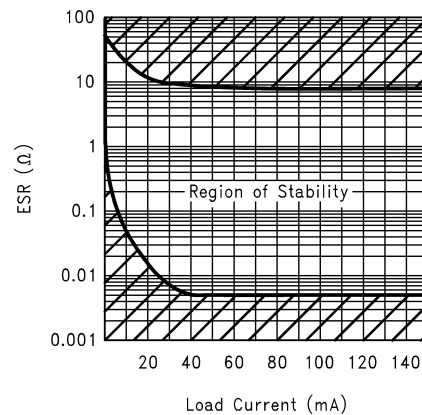

Figure 31. ESR Curve for $V_{\text{OUT}} = 3.3\text{V}$ and $C_{\text{OUT}} = 2.2\mu\text{F}$

LP2966 works best with Tantalum capacitors. However, the ESR and the capacitance value of these capacitors vary a lot with temperature, voltage, and frequency. So while using Tantalum capacitors, it should be ensured that the ESR is within the limits for stability over the full operating temperature range.

For output voltages greater than 2.5V, good quality ceramic capacitors (such as the X7R series from Taiyoyuden) can also be used with LP2966 in applications not requiring light load operation ($< 5\text{mA}$ for the 5V output option). Once again, it should be ensured that the capacitance value and the ESR are within the limits for stability over the full operating temperature range.

The ESRD Series Polymer Aluminium Electrolytic capacitors from Cornell Dubilier are very stable over temperature and frequency. The excellent capacitance and ESR tolerance of these capacitors over voltage, temperature and frequency make these capacitors very suitable for use with LDO regulators.

Output Noise

Noise is specified in two ways:

Spot Noise or **Output Noise Density** is the RMS sum of all noise sources, measured at the regulator output, at a specific frequency (measured with a 1Hz bandwidth). This type of noise is usually plotted on a curve as a function of frequency.

Total Output Noise or **Broad-Band Noise** is the RMS sum of spot noise over a specified bandwidth, usually several decades of frequencies.

Attention should be paid to the units of measurement. Spot noise is measured in units $\mu\text{V}/\sqrt{\text{Hz}}$ or $\text{nV}/\sqrt{\text{Hz}}$ and total output noise is measured in $\mu\text{V}(\text{rms})$.

The primary source of noise in low-dropout regulators is the internal reference. In CMOS regulators, noise has a low frequency component and a high frequency component, which strongly depend on the silicon area and quiescent current. Noise can be reduced in two ways: by increasing the transistor area or by increasing the current drawn by the internal reference. Increasing the area will increase the die size and decreases the chance of fitting the die into a small package. Increasing the current drawn by the internal reference increases the total supply current (ground pin current) of the IC. Using an optimized trade-off of ground pin current and die size, LP2966 achieves low noise performance with low quiescent current in an VSSOP-8 package.

Short-Circuit Foldback Protection

In the presence of a short or excessive load current condition, the LP2966 uses an internal short circuit foldback mechanism that regulates the maximum deliverable output current. A strong negative temperature coefficient is designed into the circuit to enable extremely higher peak output current capability (in excess of 400mA per output at room temperature, see [TYPICAL PERFORMANCE CHARACTERISTICS](#)). Thus, a system designer using the LP2966 can achieve higher peak output current capability in applications where the LP2966 internal junction temperature is kept below 125°C. Refer to [APPLICATIONS INFORMATION](#) on calculating the maximum output current capability of the LP2966 for your application.

Error Flag Operation

The LP2966 produces a logic low signal at the Error Flag pin ($\overline{\text{ERROR}}$) when the corresponding output drops out of regulation due to low input voltage, current limiting, or thermal limiting. This flag has a built in Hysteresis. The timing diagram in [Figure 32](#) shows the relationship between the $\overline{\text{ERROR}}$ and the output voltage. In this example, the input voltage is changed to demonstrate the functionality of the Error Flag.

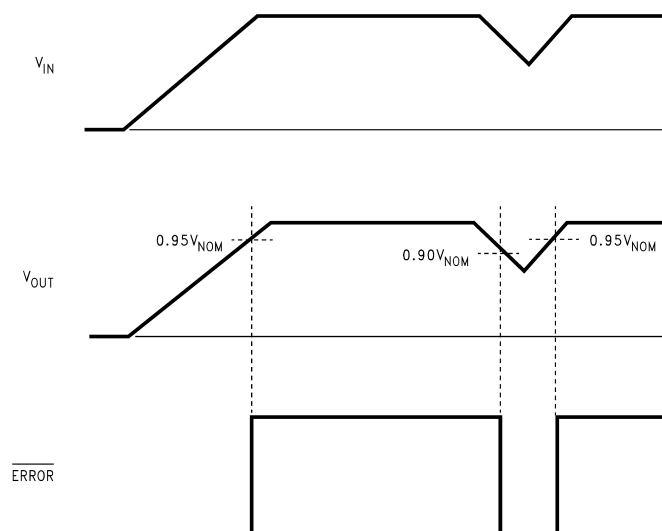

Figure 32. Error Flag Operation

The internal error flag comparators have open drain output stages. Hence, the $\overline{\text{ERROR}}$ pins should be pulled high through a pull up resistor. Although the $\overline{\text{ERROR}}$ pin can sink current of 1mA, this current adds to the battery drain. Hence, the value of the pull up resistor should be in the range of 100k Ω to 1M Ω . **The $\overline{\text{ERROR}}$ pins must be connected to ground if this function is not used.** It should also be noted that when the shutdown pins are pulled low, the $\overline{\text{ERROR}}$ pins are forced to be invalid for reasons of saving power in shutdown mode.

Shutdown Operation

The two LDO regulators in the LP2966 have independent shutdown. A CMOS Logic level signal at the shutdown ($\overline{\text{SD}}$) pin will turn-off the corresponding regulator. Pins $\overline{\text{SD1}}$ and $\overline{\text{SD2}}$ must be actively terminated through a 100k Ω pull-up resistor for a proper operation. If these pins are driven from a source that actively pulls high and low (such as a CMOS rail to rail comparator), the pull-up resistor is not required. These pins must be tied to V_{in} if not used.

Drop-Out Voltage

The drop-out voltage of a regulator is defined as the minimum input-to-output differential required to stay within 100mV of the output voltage measured with a 1V differential. The LP2966 uses an internal MOSFET with an $R_{ds(on)}$ of 1 Ω . For CMOS LDOs, the drop-out voltage is the product of the load current and the $R_{ds(on)}$ of the internal MOSFET.

Reverse Current Path

The internal MOSFET in the LP2966 has an inherent parasitic diode. During normal operation, the input voltage is higher than the output voltage and the parasitic diode is reverse biased. However, if the output is pulled above the input in an application, then current flows from the output to the input as the parasitic diode gets forward biased. The output can be pulled above the input as long as the current in the parasitic diode is limited to 150mA.

Maximum Output Current Capability

Each output in the LP2966 can deliver a current of more than 150mA over the full operating temperature range. However, the maximum output current capability should be derated by the junction temperature. Under all possible conditions, the junction temperature must be within the range specified under operating conditions. The LP2966 is available in VSSOP-8 package. This package has a junction to ambient temperature coefficient (θ_{ja}) of 235 $^{\circ}\text{C}/\text{W}$ with minimum amount of copper area. The total power dissipation of the device is approximately given by:

$$P_D = (V_{in} - V_{OUT1})I_{OUT1} + (V_{in} - V_{OUT2})I_{OUT2} \quad (1)$$

The maximum power dissipation, P_{Dmax} , that the device can tolerate can be calculated by using the formula:

$$P_{Dmax} = (T_{jmax} - T_A)/\theta_{ja}$$

where

- T_{jmax} is the maximum specified junction temperature (125 $^{\circ}\text{C}$)
 - T_A is the ambient temperature
- (2)

Figure 33 through Figure 37 show the variation of thermal coefficient with different layout scenarios.

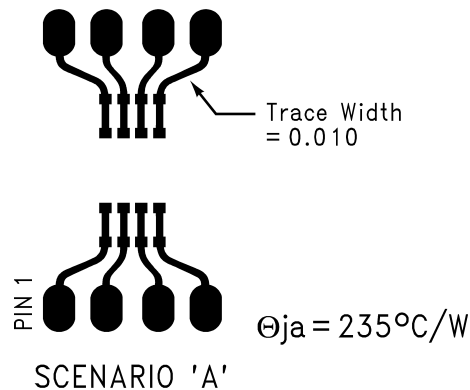

Figure 33.

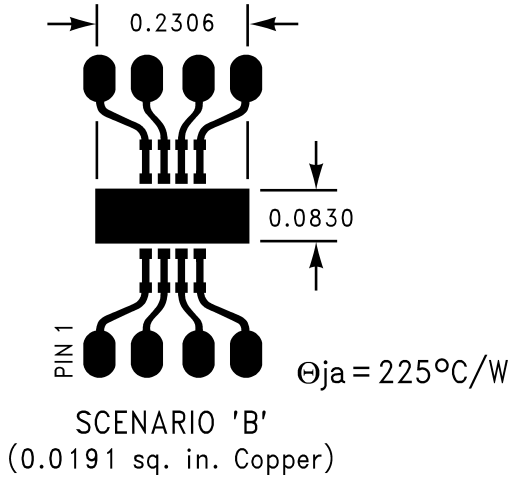

Figure 34.

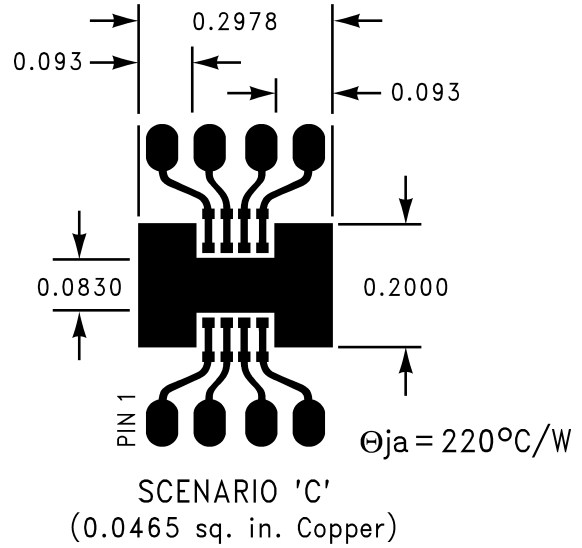

Figure 35.

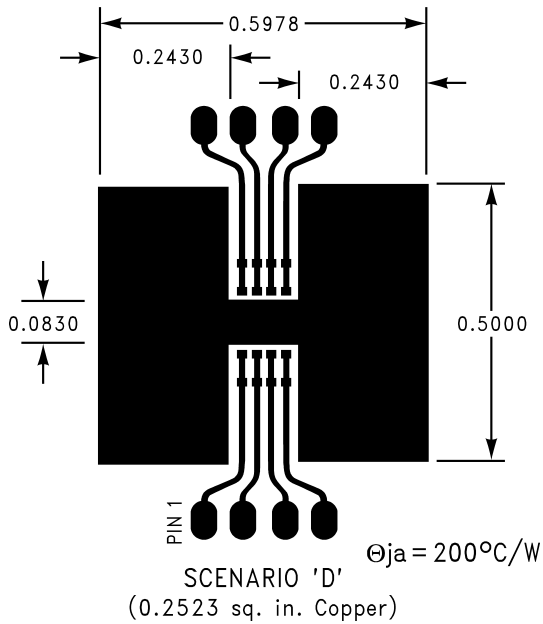

Figure 36.

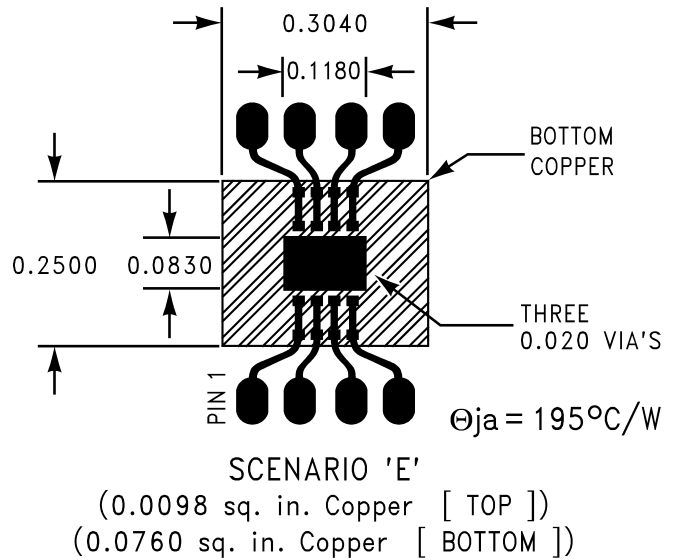

Figure 37.

REVISION HISTORY

Changes from Revision D (April 2013) to Revision E	Page
• Changed layout of National Data Sheet to TI format	14

PACKAGING INFORMATION

Orderable Device	Status (1)	Package Type	Package Drawing	Pins	Package Qty	Eco Plan (2)	Lead/Ball Finish (6)	MSL Peak Temp (3)	Op Temp (°C)	Device Marking (4/5)	Samples
LP2966IMM-1833/NOPB	ACTIVE	VSSOP	DGK	8	1000	Green (RoHS & no Sb/Br)	CU SN	Level-1-260C-UNLIM	-40 to 125	LCFB	Samples
LP2966IMM-2518/NOPB	ACTIVE	VSSOP	DGK	8	1000	Green (RoHS & no Sb/Br)	CU SN	Level-1-260C-UNLIM		LJKB	Samples
LP2966IMM-2525/NOPB	ACTIVE	VSSOP	DGK	8	1000	Green (RoHS & no Sb/Br)	CU SN	Level-1-260C-UNLIM	-40 to 125	LAAB	Samples
LP2966IMM-2828/NOPB	ACTIVE	VSSOP	DGK	8	1000	Green (RoHS & no Sb/Br)	CU SN	Level-1-260C-UNLIM	-40 to 125	LABB	Samples
LP2966IMM-3325	NRND	VSSOP	DGK	8	1000	TBD	Call TI	Call TI		LARB	
LP2966IMM-3325/NOPB	ACTIVE	VSSOP	DGK	8	1000	Green (RoHS & no Sb/Br)	CU SN	Level-1-260C-UNLIM		LARB	Samples
LP2966IMM-5050/NOPB	ACTIVE	VSSOP	DGK	8	1000	Green (RoHS & no Sb/Br)	CU SN	Level-1-260C-UNLIM	-40 to 125	LAFB	Samples
LP2966IMMX-3325	NRND	VSSOP	DGK	8		TBD	Call TI	Call TI		LARB	
LP2966IMMX-3325/NOPB	ACTIVE	VSSOP	DGK	8	3500	Green (RoHS & no Sb/Br)	CU SN	Level-1-260C-UNLIM		LARB	Samples

(1) The marketing status values are defined as follows:

ACTIVE: Product device recommended for new designs.

LIFEBUY: TI has announced that the device will be discontinued, and a lifetime-buy period is in effect.

NRND: Not recommended for new designs. Device is in production to support existing customers, but TI does not recommend using this part in a new design.

PREVIEW: Device has been announced but is not in production. Samples may or may not be available.

OBSOLETE: TI has discontinued the production of the device.

(2) Eco Plan - The planned eco-friendly classification: Pb-Free (RoHS), Pb-Free (RoHS Exempt), or Green (RoHS & no Sb/Br) - please check <http://www.ti.com/productcontent> for the latest availability information and additional product content details.

TBD: The Pb-Free/Green conversion plan has not been defined.

Pb-Free (RoHS): TI's terms "Lead-Free" or "Pb-Free" mean semiconductor products that are compatible with the current RoHS requirements for all 6 substances, including the requirement that lead not exceed 0.1% by weight in homogeneous materials. Where designed to be soldered at high temperatures, TI Pb-Free products are suitable for use in specified lead-free processes.

Pb-Free (RoHS Exempt): This component has a RoHS exemption for either 1) lead-based flip-chip solder bumps used between the die and package, or 2) lead-based die adhesive used between the die and leadframe. The component is otherwise considered Pb-Free (RoHS compatible) as defined above.

Green (RoHS & no Sb/Br): TI defines "Green" to mean Pb-Free (RoHS compatible), and free of Bromine (Br) and Antimony (Sb) based flame retardants (Br or Sb do not exceed 0.1% by weight in homogeneous material)

(3) MSL, Peak Temp. - The Moisture Sensitivity Level rating according to the JEDEC industry standard classifications, and peak solder temperature.

(4) There may be additional marking, which relates to the logo, the lot trace code information, or the environmental category on the device.

(5) Multiple Device Markings will be inside parentheses. Only one Device Marking contained in parentheses and separated by a "~" will appear on a device. If a line is indented then it is a continuation of the previous line and the two combined represent the entire Device Marking for that device.

(6) Lead/Ball Finish - Orderable Devices may have multiple material finish options. Finish options are separated by a vertical ruled line. Lead/Ball Finish values may wrap to two lines if the finish value exceeds the maximum column width.

Important Information and Disclaimer:The information provided on this page represents TI's knowledge and belief as of the date that it is provided. TI bases its knowledge and belief on information provided by third parties, and makes no representation or warranty as to the accuracy of such information. Efforts are underway to better integrate information from third parties. TI has taken and continues to take reasonable steps to provide representative and accurate information but may not have conducted destructive testing or chemical analysis on incoming materials and chemicals. TI and TI suppliers consider certain information to be proprietary, and thus CAS numbers and other limited information may not be available for release.

In no event shall TI's liability arising out of such information exceed the total purchase price of the TI part(s) at issue in this document sold by TI to Customer on an annual basis.

TAPE AND REEL INFORMATION

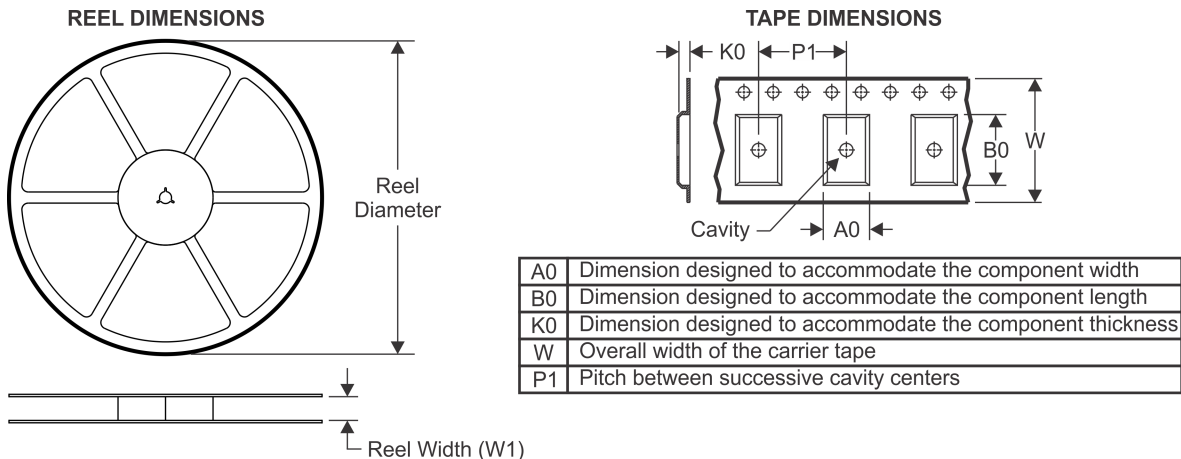

QUADRANT ASSIGNMENTS FOR PIN 1 ORIENTATION IN TAPE



*All dimensions are nominal

Device	Package Type	Package Drawing	Pins	SPQ	Reel Diameter (mm)	Reel Width W1 (mm)	A0 (mm)	B0 (mm)	K0 (mm)	P1 (mm)	W (mm)	Pin1 Quadrant
LP2966IMM-1833/NOPB	VSSOP	DGK	8	1000	178.0	12.4	5.3	3.4	1.4	8.0	12.0	Q1
LP2966IMM-2518/NOPB	VSSOP	DGK	8	1000	178.0	12.4	5.3	3.4	1.4	8.0	12.0	Q1
LP2966IMM-2525/NOPB	VSSOP	DGK	8	1000	178.0	12.4	5.3	3.4	1.4	8.0	12.0	Q1
LP2966IMM-2828/NOPB	VSSOP	DGK	8	1000	178.0	12.4	5.3	3.4	1.4	8.0	12.0	Q1
LP2966IMM-3325	VSSOP	DGK	8	1000	178.0	12.4	5.3	3.4	1.4	8.0	12.0	Q1
LP2966IMM-3325/NOPB	VSSOP	DGK	8	1000	178.0	12.4	5.3	3.4	1.4	8.0	12.0	Q1
LP2966IMM-5050/NOPB	VSSOP	DGK	8	1000	178.0	12.4	5.3	3.4	1.4	8.0	12.0	Q1
LP2966IMMX-3325/NOPB	VSSOP	DGK	8	3500	330.0	12.4	5.3	3.4	1.4	8.0	12.0	Q1

TAPE AND REEL BOX DIMENSIONS

*All dimensions are nominal

Device	Package Type	Package Drawing	Pins	SPQ	Length (mm)	Width (mm)	Height (mm)
LP2966IMM-1833/NOPB	VSSOP	DGK	8	1000	210.0	185.0	35.0
LP2966IMM-2518/NOPB	VSSOP	DGK	8	1000	210.0	185.0	35.0
LP2966IMM-2525/NOPB	VSSOP	DGK	8	1000	210.0	185.0	35.0
LP2966IMM-2828/NOPB	VSSOP	DGK	8	1000	210.0	185.0	35.0
LP2966IMM-3325	VSSOP	DGK	8	1000	210.0	185.0	35.0
LP2966IMM-3325/NOPB	VSSOP	DGK	8	1000	210.0	185.0	35.0
LP2966IMM-5050/NOPB	VSSOP	DGK	8	1000	210.0	185.0	35.0
LP2966IMMX-3325/NOPB	VSSOP	DGK	8	3500	367.0	367.0	35.0

DGK (S-PDSO-G8)

PLASTIC SMALL-OUTLINE PACKAGE



- NOTES:
- A. All linear dimensions are in millimeters.
 - B. This drawing is subject to change without notice.
 - C. Body length does not include mold flash, protrusions, or gate burrs. Mold flash, protrusions, or gate burrs shall not exceed 0.15 per end.
 - D. Body width does not include interlead flash. Interlead flash shall not exceed 0.50 per side.
 - E. Falls within JEDEC MO-187 variation AA, except interlead flash.



- NOTES:
- A. All linear dimensions are in millimeters.
 - B. This drawing is subject to change without notice.
 - C. Publication IPC-7351 is recommended for alternate designs.
 - D. Laser cutting apertures with trapezoidal walls and also rounding corners will offer better paste release. Customers should contact their board assembly site for stencil design recommendations. Refer to IPC-7525 for other stencil recommendations.
 - E. Customers should contact their board fabrication site for solder mask tolerances between and around signal pads.

IMPORTANT NOTICE

Texas Instruments Incorporated and its subsidiaries (TI) reserve the right to make corrections, enhancements, improvements and other changes to its semiconductor products and services per JESD46, latest issue, and to discontinue any product or service per JESD48, latest issue. Buyers should obtain the latest relevant information before placing orders and should verify that such information is current and complete. All semiconductor products (also referred to herein as "components") are sold subject to TI's terms and conditions of sale supplied at the time of order acknowledgment.

TI warrants performance of its components to the specifications applicable at the time of sale, in accordance with the warranty in TI's terms and conditions of sale of semiconductor products. Testing and other quality control techniques are used to the extent TI deems necessary to support this warranty. Except where mandated by applicable law, testing of all parameters of each component is not necessarily performed.

TI assumes no liability for applications assistance or the design of Buyers' products. Buyers are responsible for their products and applications using TI components. To minimize the risks associated with Buyers' products and applications, Buyers should provide adequate design and operating safeguards.

TI does not warrant or represent that any license, either express or implied, is granted under any patent right, copyright, mask work right, or other intellectual property right relating to any combination, machine, or process in which TI components or services are used. Information published by TI regarding third-party products or services does not constitute a license to use such products or services or a warranty or endorsement thereof. Use of such information may require a license from a third party under the patents or other intellectual property of the third party, or a license from TI under the patents or other intellectual property of TI.

Reproduction of significant portions of TI information in TI data books or data sheets is permissible only if reproduction is without alteration and is accompanied by all associated warranties, conditions, limitations, and notices. TI is not responsible or liable for such altered documentation. Information of third parties may be subject to additional restrictions.

Resale of TI components or services with statements different from or beyond the parameters stated by TI for that component or service voids all express and any implied warranties for the associated TI component or service and is an unfair and deceptive business practice. TI is not responsible or liable for any such statements.

Buyer acknowledges and agrees that it is solely responsible for compliance with all legal, regulatory and safety-related requirements concerning its products, and any use of TI components in its applications, notwithstanding any applications-related information or support that may be provided by TI. Buyer represents and agrees that it has all the necessary expertise to create and implement safeguards which anticipate dangerous consequences of failures, monitor failures and their consequences, lessen the likelihood of failures that might cause harm and take appropriate remedial actions. Buyer will fully indemnify TI and its representatives against any damages arising out of the use of any TI components in safety-critical applications.

In some cases, TI components may be promoted specifically to facilitate safety-related applications. With such components, TI's goal is to help enable customers to design and create their own end-product solutions that meet applicable functional safety standards and requirements. Nonetheless, such components are subject to these terms.

No TI components are authorized for use in FDA Class III (or similar life-critical medical equipment) unless authorized officers of the parties have executed a special agreement specifically governing such use.

Only those TI components which TI has specifically designated as military grade or "enhanced plastic" are designed and intended for use in military/aerospace applications or environments. Buyer acknowledges and agrees that any military or aerospace use of TI components which have **not** been so designated is solely at the Buyer's risk, and that Buyer is solely responsible for compliance with all legal and regulatory requirements in connection with such use.

TI has specifically designated certain components as meeting ISO/TS16949 requirements, mainly for automotive use. In any case of use of non-designated products, TI will not be responsible for any failure to meet ISO/TS16949.

Products

Audio	www.ti.com/audio
Amplifiers	amplifier.ti.com
Data Converters	dataconverter.ti.com
DLP® Products	www.dlp.com
DSP	dsp.ti.com
Clocks and Timers	www.ti.com/clocks
Interface	interface.ti.com
Logic	logic.ti.com
Power Mgmt	power.ti.com
Microcontrollers	microcontroller.ti.com
RFID	www.ti-rfid.com
OMAP Applications Processors	www.ti.com/omap
Wireless Connectivity	www.ti.com/wirelessconnectivity

Applications

Automotive and Transportation	www.ti.com/automotive
Communications and Telecom	www.ti.com/communications
Computers and Peripherals	www.ti.com/computers
Consumer Electronics	www.ti.com/consumer-apps
Energy and Lighting	www.ti.com/energy
Industrial	www.ti.com/industrial
Medical	www.ti.com/medical
Security	www.ti.com/security
Space, Avionics and Defense	www.ti.com/space-avionics-defense
Video and Imaging	www.ti.com/video

TI E2E Community

e2e.ti.com