

PROTECTION PRODUCTS - RailClamp®

Description

The RClamp®0582BQ transient voltage suppressor is specifically designed to protect sensitive components which are connected to high-speed data and transmission lines from overvoltage caused by ESD (electrostatic discharge), CDE (cable discharge events), and EFT (electrical fast transients). It is rated to Grade 2 of AEC-Q100 for use in automotive applications.

The RClamp®0582BQ features high peak pulse current capability ($I_{pp}=15A$, $t_p=8/20\mu s$) for use in applications that require high surge immunity testing. It has a maximum capacitance of only 1.2pF (pin 1 or 2 to pin3). They may be used to meet the ESD immunity requirements of IEC 61000-4-2 ($\pm 30kV$ air, $\pm 25kV$ contact discharge). Each device can be configured to protect 1 bidirectional line or two unidirectional lines.

These devices are in a small SC-75 (SOT-523) package and feature a lead-free, matte tin finish. They are compatible with both lead free and SnPb assembly techniques. The combination of small size, low capacitance, and high level of surge protection makes them a flexible solution for protection of USB 2.0, LVDS, and video interfaces.

Features

- ◆ Transient protection for high-speed data lines to **IEC 61000-4-2 (ESD) $\pm 30kV$ (air), $\pm 25kV$ (contact)**
IEC 61000-4-4 (EFT) 40A (5/50ns)
- ◆ Qualified to AEC-Q100, Grade 2
- ◆ Protects up to two I/O lines
- ◆ Low capacitance (**$<1.2pF$**)
- ◆ High surge capability: **15A ($t_p=8/20\mu s$)**
- ◆ Low leakage current and clamping voltage
- ◆ Low operating voltage: 5.0V
- ◆ Solid-state silicon-avalanche technology

Mechanical Characteristics

- ◆ SC-75 (SOT-523) package
- ◆ Lead Finish: Matte Tin
- ◆ Pb-Free, Halogen Free, RoHS/WEEE Compliant
- ◆ Molding compound flammability rating: UL 94V-0
- ◆ Packaging: Tape and Reel

Applications

- ◆ USB 2.0
- ◆ Video Lines
- ◆ LVDS Lines

Dimensions

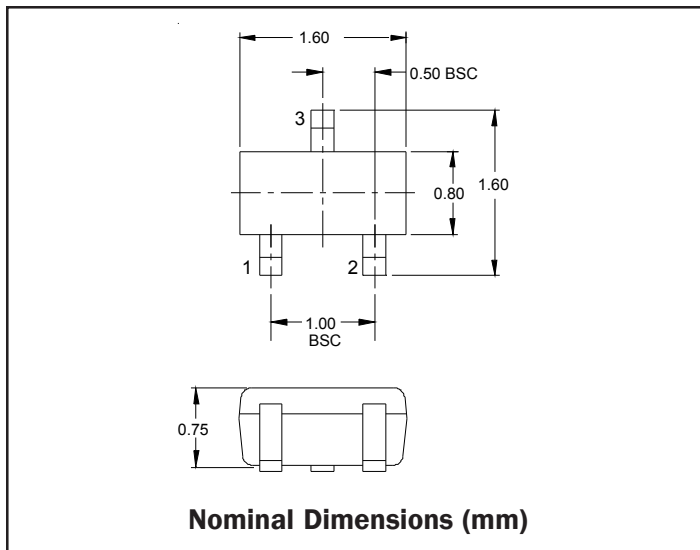

Schematic & PIN Configuration

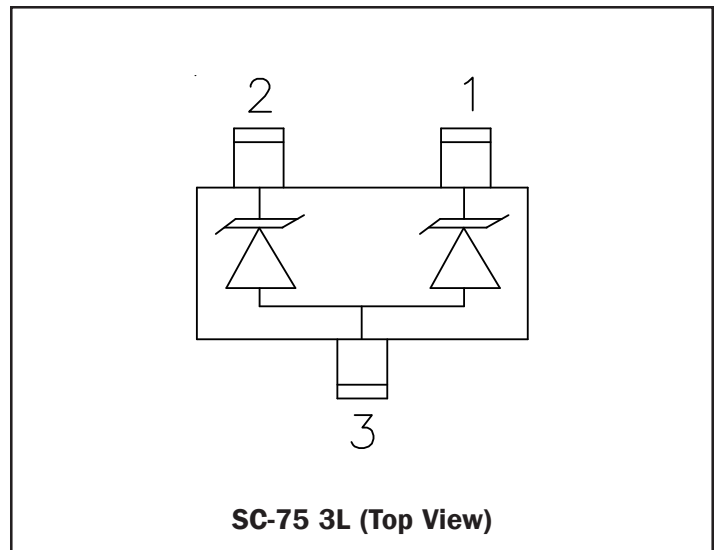

PROTECTION PRODUCTS
Absolute Maximum Rating

Rating	Symbol	Value	Units
Peak Pulse Power (tp = 8/20μs)	P_{pk}	300	Watts
Peak Pulse Current (tp = 8/20μs)	I_{pp}	15	A
ESD per IEC 61000-4-2 (Air) ESD per IEC 61000-4-2 (Contact)	V_{ESD}	30 25	kV
Operating Temperature	T_J	-40 to +105	°C
Storage Temperature	T_{STG}	-55 to +150	°C

Electrical Characteristics (T=25°C)

Parameter	Symbol	Conditions	Minimum	Typical	Maximum	Units
Reverse Stand-Off Voltage	V_{RWM}	Pin 1 or Pin 2 to Pin 3			5	V
Reverse Breakdown Voltage	V_{BR}	$I_t = 1mA$ Pin 1 or Pin 2 to Pin 3	6		11	V
Reverse Leakage Current	I_R	$V_{RWM} = 5V, T=25°C$ Pin 1 or Pin 2 to Pin 3 and Between Pins 1 and 2			0.100	μA
Reverse Leakage Current	I_R	$V_{RWM} = 5V, T=105°C$ Pin 1 or Pin 2 to Pin 3 and Between Pins 1 and 2			0.300	μA
Clamping Voltage	V_C	$I_{pp} = 5A, tp = 8/20μs$ Pin 1 or Pin 2 to Pin 3			15	V
Clamping Voltage	V_C	$I_{pp} = 15A, tp = 8/20μs$ Pin 1 or Pin 2 to Pin 3			20	V
Junction Capacitance	C_j	$V_R = 0V, f = 1MHz$ Pin 1 to Pin 2		0.50	0.8	pF
Junction Capacitance	C_j	$V_R = 0V, f = 1MHz$ Pin 1 or Pin 2 to Pin 3			1.2	pF

PROTECTION PRODUCTS

Typical Characteristics

Non-Repetitive Peak Pulse Power vs. Pulse Time

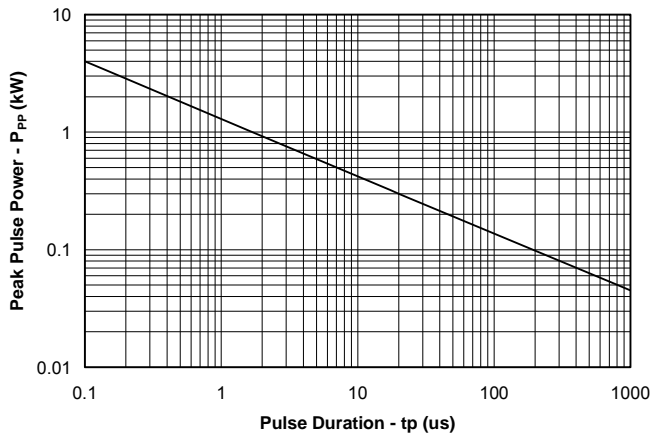

Power Derating Curve

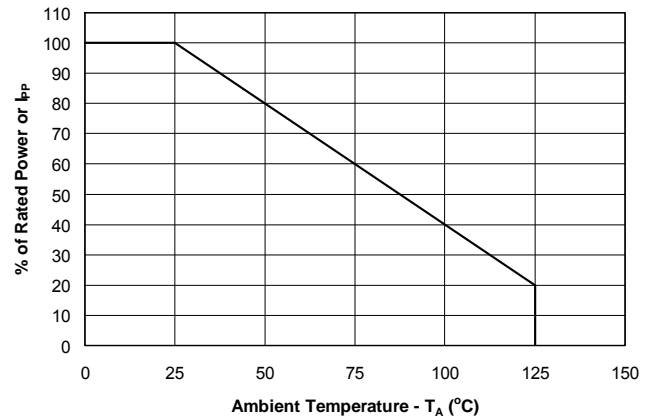

Clamping Voltage vs. Peak Pulse Current Pin 1 or Pin 2 to Pin 3

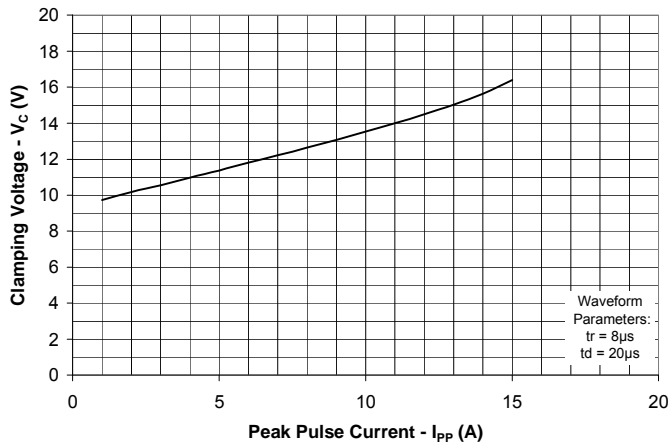

Normalized Capacitance vs. Reverse Voltage Pin 1 or Pin 2 to Pin 3

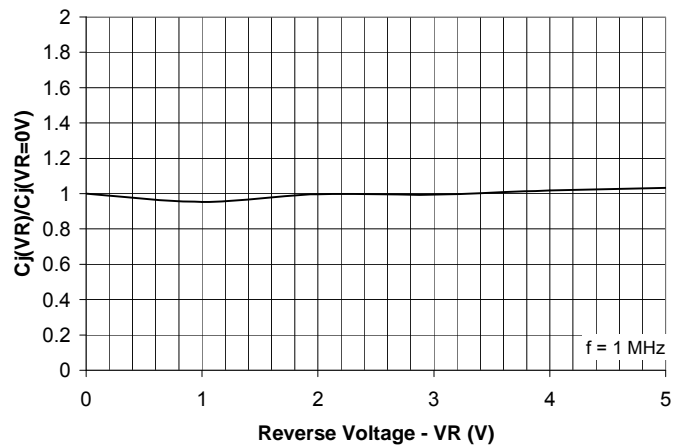

ESD Clamping - Pin 1 or Pin 2 to Pin 3 (8kV Contact per IEC 61000-4-2)

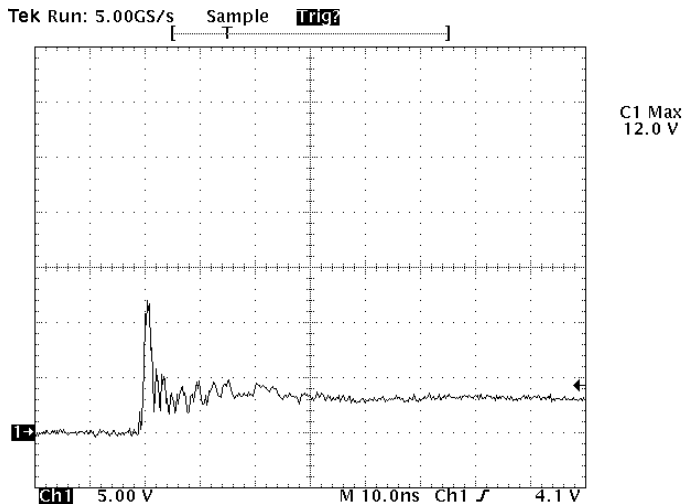

Insertion Loss S21 (Pin 1 or Pin 2 to Pin 3)

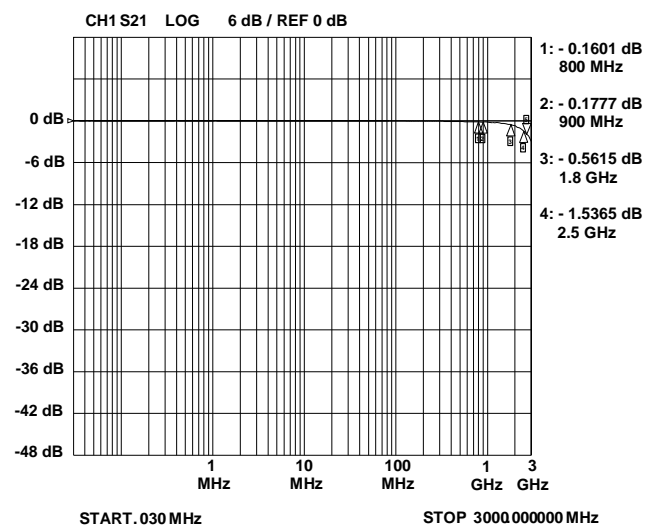

Note: Data is taken with a 10x attenuator

Forward Voltage vs. Forward Current
(Pin 3 to Pin 1 or Pin 2)

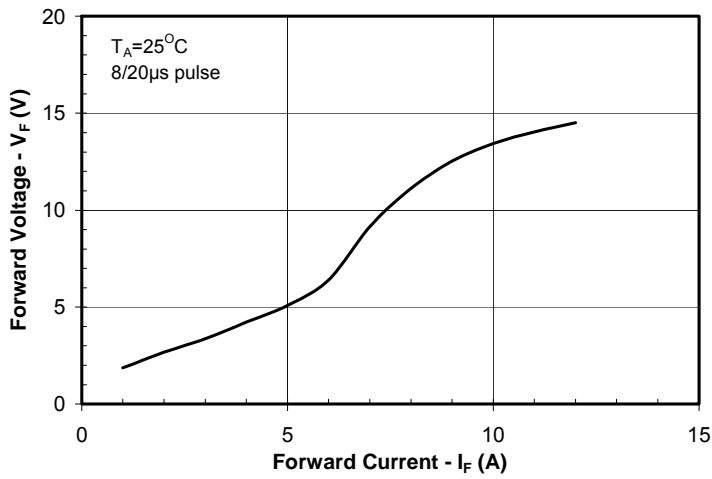

Normalized Capacitance vs. Temperature
(Pin 1 or Pin 2 to Pin 3)

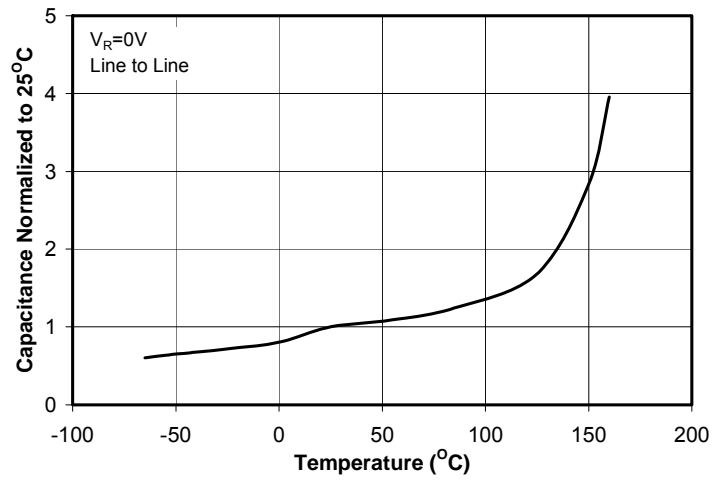

Reverse Leakage Current vs. Temperature
(Pin 1 or Pin 2 to Pin 3)

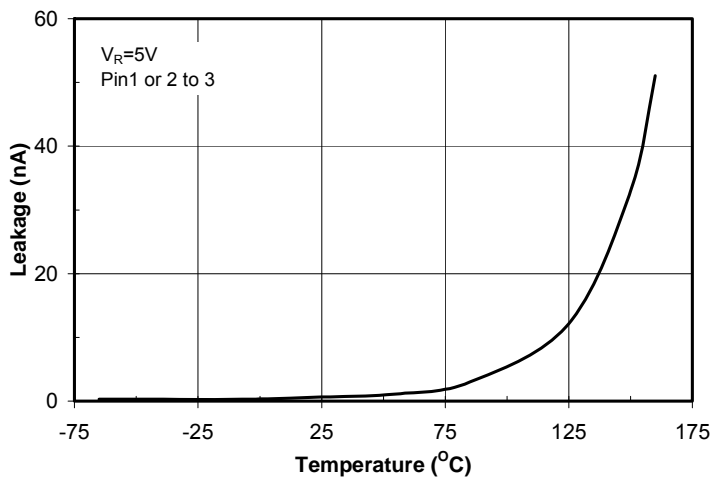

PROTECTION PRODUCTS**Applications Information****Device Connection Options**

This device is optimized for protection of two high speed data lines. The device is connected as follows:

Protection of two lines is achieved by connecting data lines at pins 1 & 2. Pin 3 is connected to ground. The connection to ground should be made directly to a ground plane. The path length should also be kept as short as possible to minimize parasitic inductance.

Matte Tin Lead Finish

Matte tin has become the industry standard lead-free replacement for SnPb lead finishes. A matte tin finish is composed of 100% tin solder with large grains. Since the solder volume on the leads is small compared to the solder paste volume that is placed on the land pattern of the PCB, the reflow profile will be determined by the requirements of the solder paste. Therefore, these devices are compatible with both lead-free and SnPb assembly techniques. In addition, unlike other lead-free compositions, matte tin does not have any added alloys that can cause degradation of the solder joint.

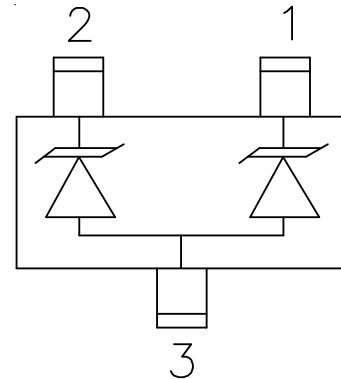
Figure 1. Pin Configuration

PROTECTION PRODUCTS

Outline Drawing -SC-75 (SOT-523)

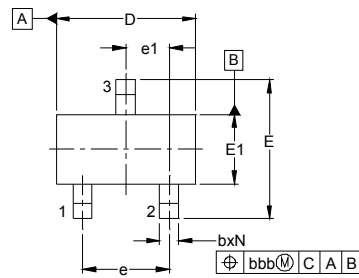

DIM	INCHES			MILLIMETERS		
	MIN	NOM	MAX	MIN	NOM	MAX
A	.023	-	.035	0.60	-	0.90
A1	.000	-	.004	0.00	-	0.10
A2	.023	.030	.031	0.60	0.75	0.80
b	.005	-	.012	0.15	-	0.30
c	.003	-	.008	0.10	-	0.20
D	.059	.063	.067	1.50	1.60	1.70
E	.057	.063	.069	1.45	1.60	1.75
E1	.029	.031	.033	0.75	0.80	0.85
e	.039 BSC			1.00 BSC		
e1	.020 BSC			0.50 BSC		
L	(.009)			(0.22)		
N	3			3		
θ	0°	-	8°	0°	-	8°
aaa	.004			0.10		
bbb	.008			0.20		

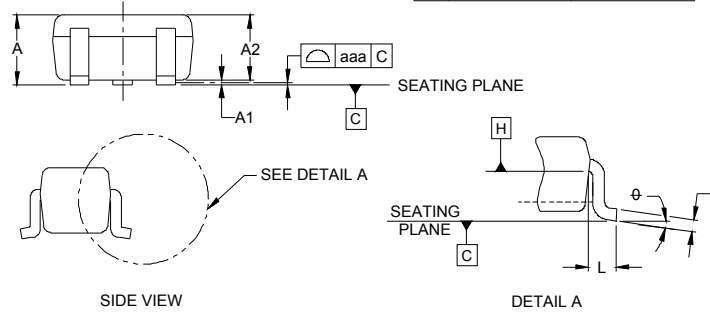

NOTES:

1. CONTROLLING DIMENSIONS ARE IN MILLIMETERS (ANGLES IN DEGREES).
2. DATUMS $-A-$ AND $-B-$ TO BE DETERMINED AT DATUM PLANE $-H-$.
3. DIMENSIONS "E1" AND "D" DO NOT INCLUDE MOLD FLASH, PROTRUSIONS OR GATE BURRS.

Land Pattern -SC-75 (SOT-523)

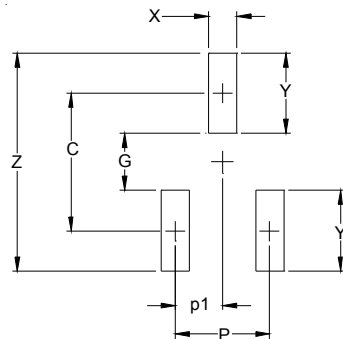

DIM	DIMENSIONS	
	INCHES	MILLIMETERS
C	(.055)	(1.40)
P	.039	1.00
p1	.020	0.50
G	.024	0.60
X	.016	0.40
Y	.031	0.80
Z	.087	2.20

NOTES:

1. THIS LAND PATTERN IS FOR REFERENCE PURPOSES ONLY CONSULT YOUR MANUFACTURING GROUP TO ENSURE YOUR COMPANY'S MANUFACTURING GUIDELINES ARE MET.

PROTECTION PRODUCTS

Marking

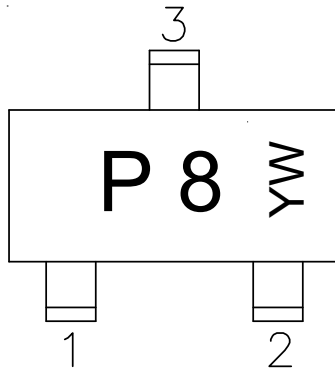

YW = Date Code

Ordering Information

Part Number	Lead Finish	Qty per Reel	Reel Size
RClamp0582BQ.TCT	Pb Free	3,000	7 Inch

RailClamp and RClamp are registered trademarks of Semtech Corporation

Tape and Reel Specification

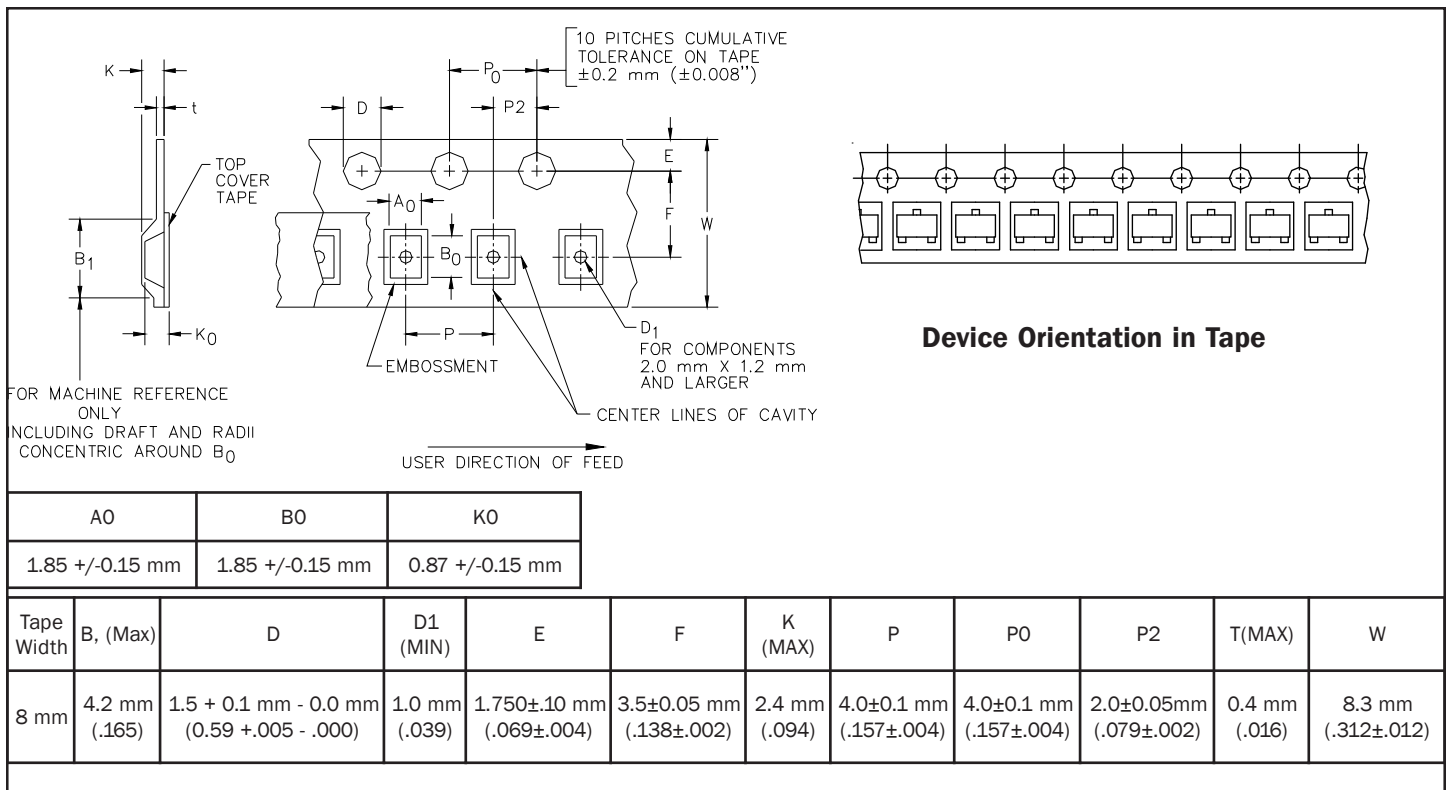

Contact Information

Semtech Corporation
 Protection Products Division
 200 Flynn Rd., Camarillo, CA 93012
 Phone: (805)498-2111 FAX (805)498-3804