

## Dual P-Channel 30-V (D-S) MOSFET

PRODUCT SUMMARY			
V <sub>DS</sub> (V)	R <sub>DS(on)</sub> (Ω)	I <sub>D</sub> (A)	Q <sub>g</sub> (Typ.)
- 30	0.020 at V <sub>GS</sub> = - 10 V	- 10.9	49
	0.031 at V <sub>GS</sub> = - 4.5 V	- 8.8	

### FEATURES

- Halogen-free According to IEC 61249-2-21 Available
- TrenchFET<sup>®</sup> Power MOSFETs
- New Low Thermal Resistance PowerPAK<sup>®</sup> Package with Low 1.07 mm Profile



**RoHS**  
COMPLIANT  
HALOGEN  
**FREE**  
Available

### APPLICATIONS

- Battery and Load Switching
  - Notebook PCs
  - Game Systems
  - Set-Top Box

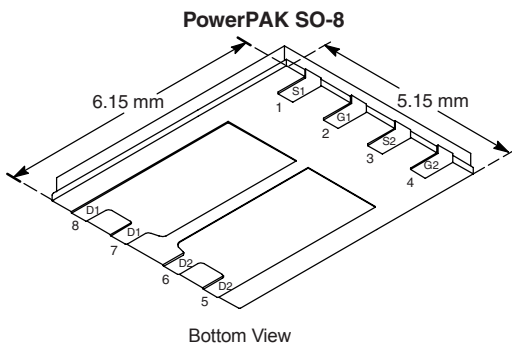

**Ordering Information:** Si7945DP-T1-E3 (Lead (Pb)-free)  
Si7945DP-T1-GE3 (Lead (Pb)-free and Halogen-free)

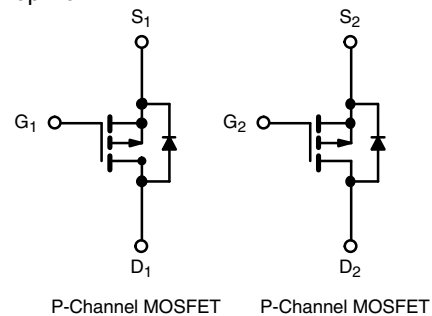

ABSOLUTE MAXIMUM RATINGS T <sub>A</sub> = 25 °C, unless otherwise noted					
Parameter	Symbol	10 s	Steady State	Unit	
Drain-Source Voltage	V <sub>DS</sub>	- 30		V	
Gate-Source Voltage	V <sub>GS</sub>	± 20			
Continuous Drain Current (T <sub>J</sub> = 150 °C) <sup>a</sup>	I <sub>D</sub>	T <sub>A</sub> = 25 °C	- 10.9	- 7.0	A
		T <sub>A</sub> = 70 °C	- 8.7	- 5.6	
Pulsed Drain Current	I <sub>DM</sub>	- 30			
Continuous Source Current (Diode Conduction) <sup>a</sup>	I <sub>S</sub>	- 2.9	- 1.2		
Maximum Power Dissipation <sup>a</sup>	P <sub>D</sub>	T <sub>A</sub> = 25 °C	3.5	1.4	W
		T <sub>A</sub> = 70 °C	2.2	0.9	
Operating Junction and Storage Temperature Range	T <sub>J</sub> , T <sub>stg</sub>	- 55 to 150		°C	
Soldering Recommendations (Peak Temperature) <sup>b, c</sup>		260			

THERMAL RESISTANCE RATINGS					
Parameter	Symbol	Typical	Maximum	Unit	
Maximum Junction-to-Ambient <sup>a</sup>	R <sub>thJA</sub>	t ≤ 10 s	26	35	°C/W
		Steady State	60	85	
Maximum Junction-to-Case (Drain)	R <sub>thJC</sub>	2.5	3.1		

Notes:

- Surface Mounted on 1" x 1" FR4 board.
- See Solder Profile ([www.vishay.com/ppg?73257](http://www.vishay.com/ppg?73257)). The PowerPAK SO-8 is a leadless package. The end of the lead terminal is exposed copper (not plated) as a result of the singulation process in manufacturing. A solder fillet at the exposed copper tip cannot be guaranteed and is not required to ensure adequate bottom side solder interconnection.
- Rework Conditions: manual soldering with a soldering iron is not recommended for leadless components.

<b>SPECIFICATIONS</b> $T_J = 25\text{ }^\circ\text{C}$ , unless otherwise noted						
Parameter	Symbol	Test Conditions	Min.	Typ.	Max.	Unit
<b>Static</b>						
Gate Threshold Voltage	$V_{GS(th)}$	$V_{DS} = V_{GS}, I_D = -250\text{ }\mu\text{A}$	- 1.0		- 3.0	V
Gate-Body Leakage	$I_{GSS}$	$V_{DS} = 0\text{ V}, V_{GS} = \pm 20\text{ V}$			$\pm 100$	nA
Zero Gate Voltage Drain Current	$I_{DSS}$	$V_{DS} = -30\text{ V}, V_{GS} = 0\text{ V}$			- 1	$\mu\text{A}$
		$V_{DS} = -30\text{ V}, V_{GS} = 0\text{ V}, T_J = 55\text{ }^\circ\text{C}$			- 5	
On-State Drain Current <sup>a</sup>	$I_{D(on)}$	$V_{DS} \leq -5\text{ V}, V_{GS} = -10\text{ V}$	- 30			A
Drain-Source On-State Resistance <sup>a</sup>	$R_{DS(on)}$	$V_{GS} = -10\text{ V}, I_D = -10.9\text{ A}$		0.016	0.020	$\Omega$
		$V_{GS} = -4.5\text{ V}, I_D = -8.8\text{ A}$		0.025	0.031	
Forward Transconductance <sup>a</sup>	$g_{fs}$	$V_{DS} = -15\text{ V}, I_D = -10.9\text{ A}$		26		S
Diode Forward Voltage <sup>a</sup>	$V_{SD}$	$I_S = -2.9\text{ A}, V_{GS} = 0\text{ V}$		- 0.8	- 1.2	V
<b>Dynamic<sup>b</sup></b>						
Total Gate Charge	$Q_g$	$V_{DS} = -15\text{ V}, V_{GS} = -10\text{ V}, I_D = -10.9\text{ A}$		49	74	nC
Gate-Source Charge	$Q_{gs}$		7.3			
Gate-Drain Charge	$Q_{gd}$		13			
Turn-On Delay Time	$t_{d(on)}$	$V_{DD} = -15\text{ V}, R_L = 15\text{ }\Omega$ $I_D \equiv -1\text{ A}, V_{GEN} = -10\text{ V}, R_g = 6\text{ }\Omega$		15	25	ns
Rise Time	$t_r$		15	25		
Turn-Off Delay Time	$t_{d(off)}$		130	200		
Fall Time	$t_f$		80	120		
Source-Drain Reverse Recovery Time	$t_{rr}$		$I_F = -2.9\text{ A}, di/dt = 100\text{ A}/\mu\text{s}$		85	

Notes:

- a. Pulse test; pulse width  $\leq 300\text{ }\mu\text{s}$ , duty cycle  $\leq 2\%$ .
- b. Guaranteed by design, not subject to production testing.

Stresses beyond those listed under "Absolute Maximum Ratings" may cause permanent damage to the device. These are stress ratings only, and functional operation of the device at these or any other conditions beyond those indicated in the operational sections of the specifications is not implied. Exposure to absolute maximum rating conditions for extended periods may affect device reliability.

## TYPICAL CHARACTERISTICS $25\text{ }^\circ\text{C}$ , unless otherwise noted

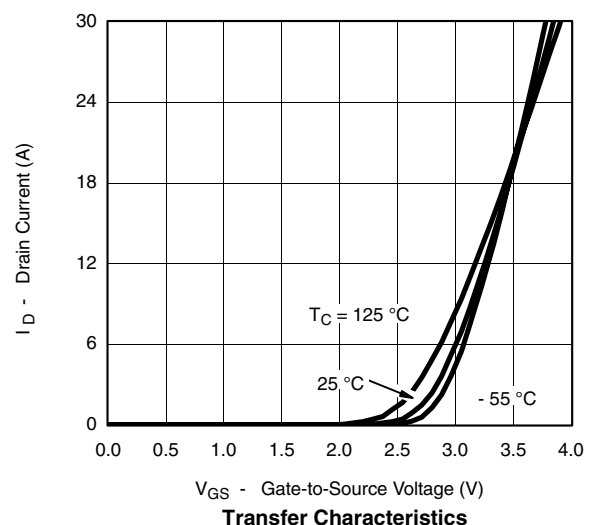
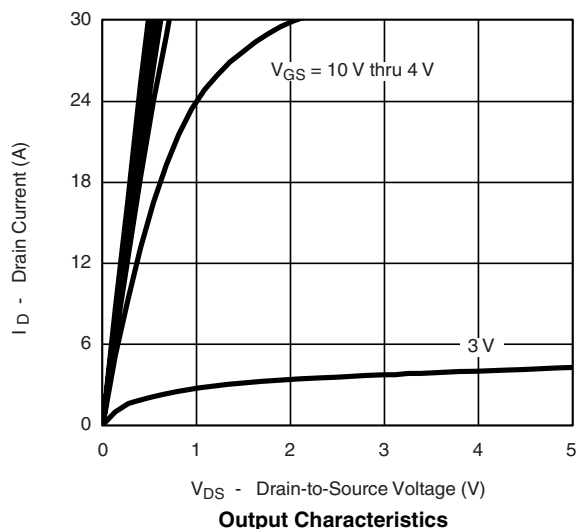

**TYPICAL CHARACTERISTICS** 25 °C, unless otherwise noted

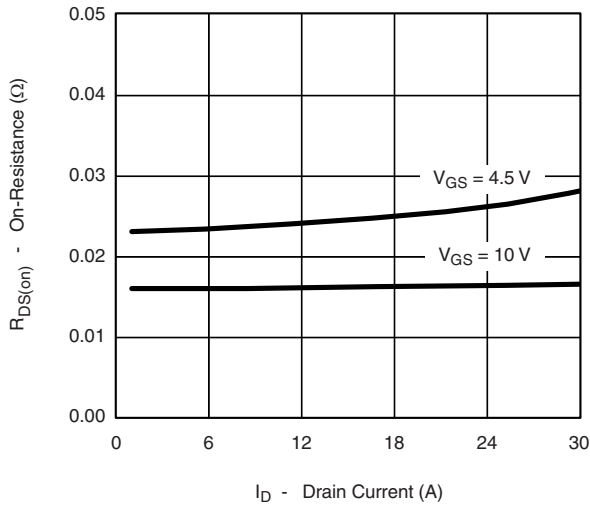

**On-Resistance vs. Drain Current**

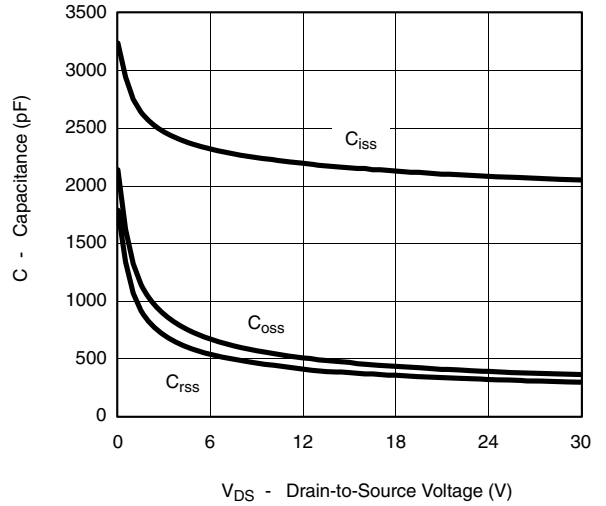

**Capacitance**

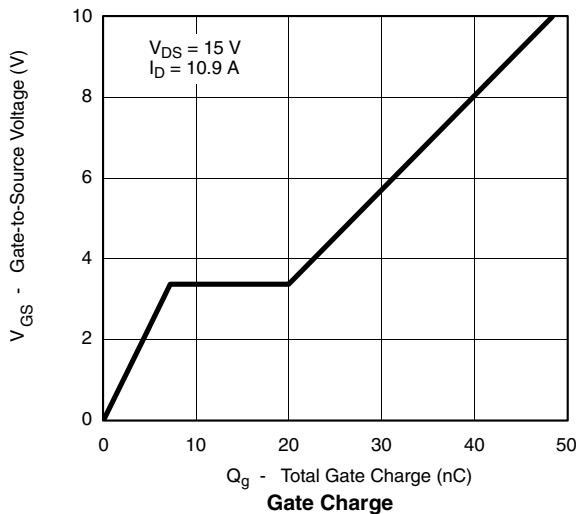

**Gate Charge**

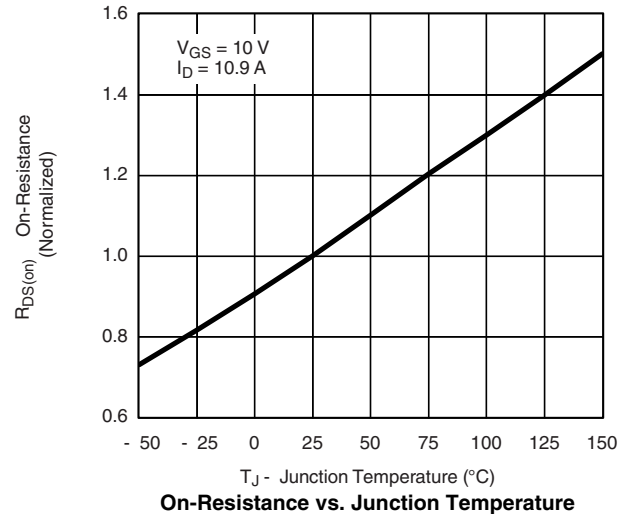

**On-Resistance vs. Junction Temperature**

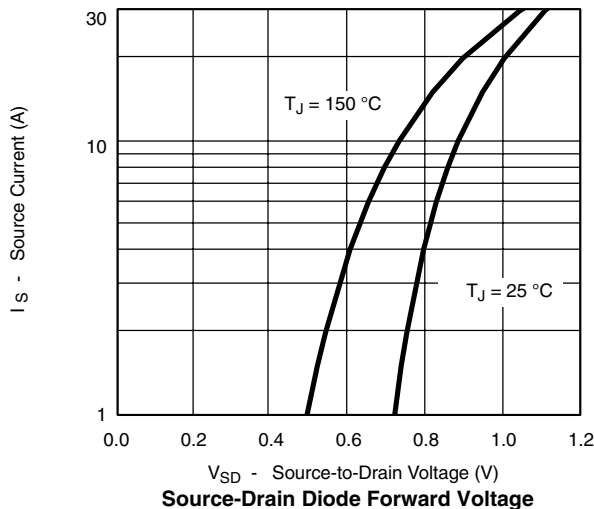

**Source-Drain Diode Forward Voltage**

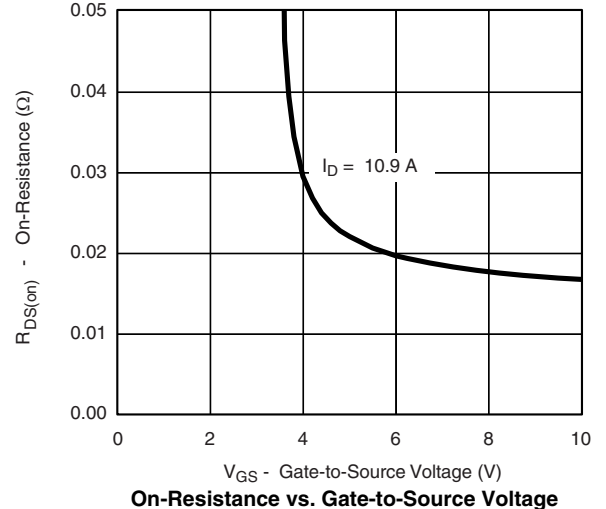

**On-Resistance vs. Gate-to-Source Voltage**

**TYPICAL CHARACTERISTICS** 25 °C, unless otherwise noted

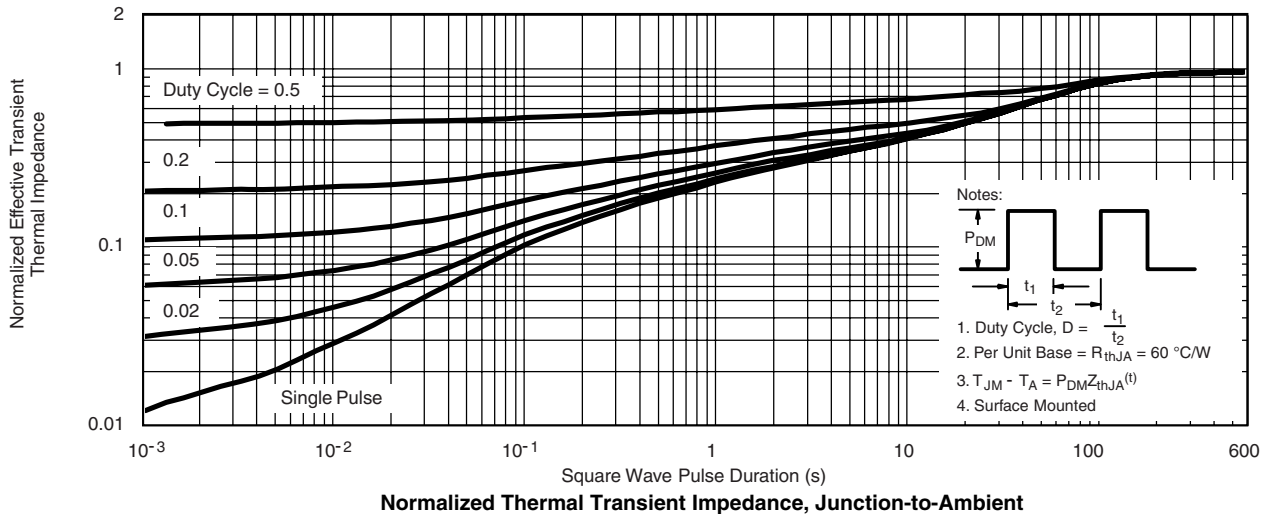
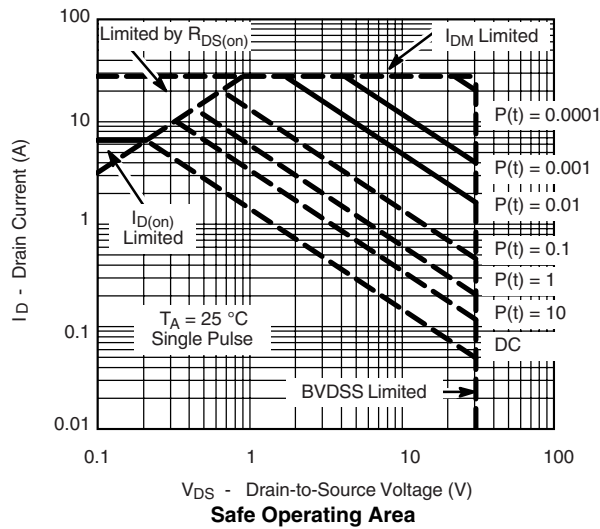
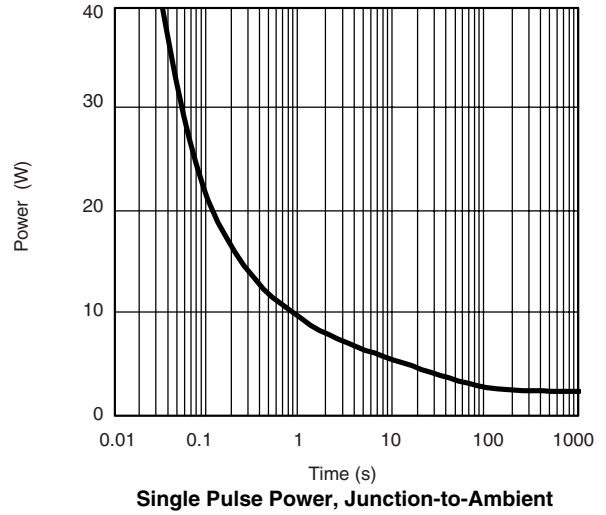
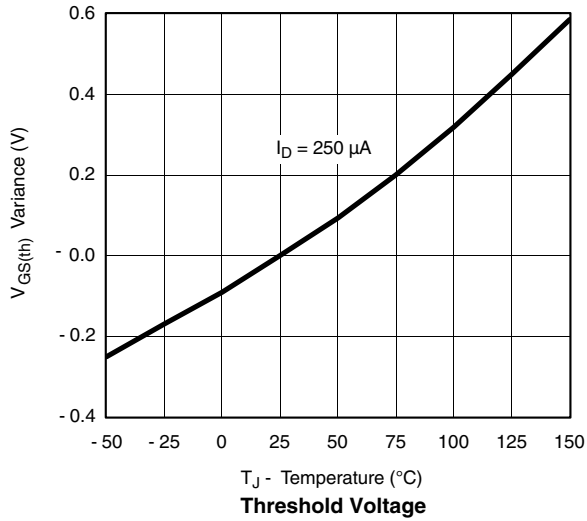



**TYPICAL CHARACTERISTICS** 25 °C, unless otherwise noted

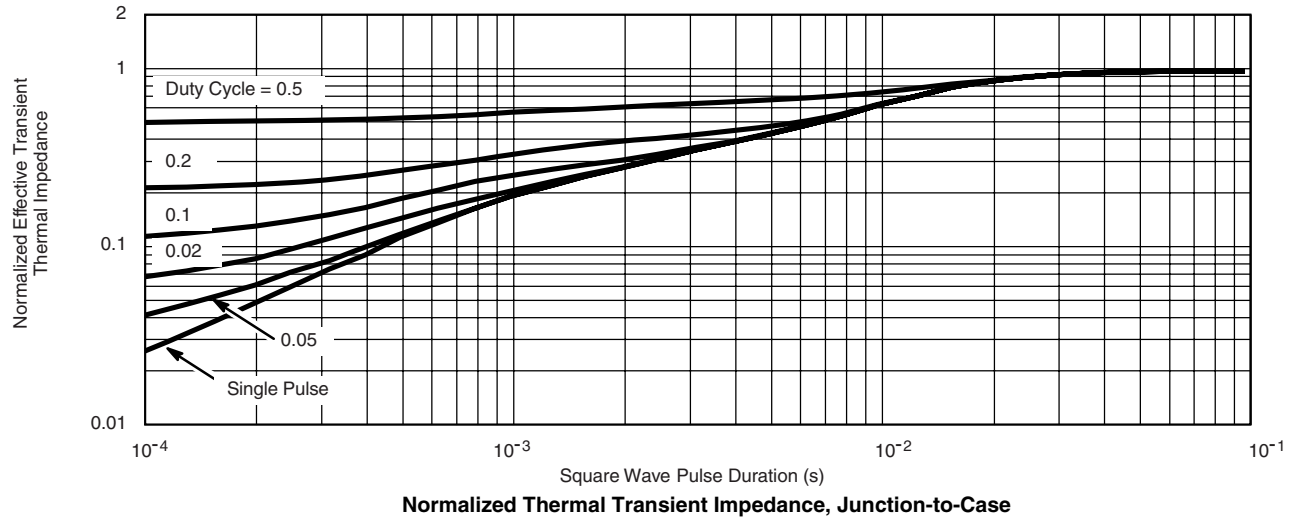

Vishay Siliconix maintains worldwide manufacturing capability. Products may be manufactured at one of several qualified locations. Reliability data for Silicon Technology and Package Reliability represent a composite of all qualified locations. For related documents such as package/tape drawings, part marking, and reliability data, see [www.vishay.com/ppg?72090](http://www.vishay.com/ppg?72090).



## Disclaimer

ALL PRODUCT, PRODUCT SPECIFICATIONS AND DATA ARE SUBJECT TO CHANGE WITHOUT NOTICE TO IMPROVE RELIABILITY, FUNCTION OR DESIGN OR OTHERWISE.

Vishay Intertechnology, Inc., its affiliates, agents, and employees, and all persons acting on its or their behalf (collectively, "Vishay"), disclaim any and all liability for any errors, inaccuracies or incompleteness contained in any datasheet or in any other disclosure relating to any product.

Vishay makes no warranty, representation or guarantee regarding the suitability of the products for any particular purpose or the continuing production of any product. To the maximum extent permitted by applicable law, Vishay disclaims (i) any and all liability arising out of the application or use of any product, (ii) any and all liability, including without limitation special, consequential or incidental damages, and (iii) any and all implied warranties, including warranties of fitness for particular purpose, non-infringement and merchantability.

Statements regarding the suitability of products for certain types of applications are based on Vishay's knowledge of typical requirements that are often placed on Vishay products in generic applications. Such statements are not binding statements about the suitability of products for a particular application. It is the customer's responsibility to validate that a particular product with the properties described in the product specification is suitable for use in a particular application. Parameters provided in datasheets and/or specifications may vary in different applications and performance may vary over time. All operating parameters, including typical parameters, must be validated for each customer application by the customer's technical experts. Product specifications do not expand or otherwise modify Vishay's terms and conditions of purchase, including but not limited to the warranty expressed therein.

Except as expressly indicated in writing, Vishay products are not designed for use in medical, life-saving, or life-sustaining applications or for any other application in which the failure of the Vishay product could result in personal injury or death. Customers using or selling Vishay products not expressly indicated for use in such applications do so at their own risk. Please contact authorized Vishay personnel to obtain written terms and conditions regarding products designed for such applications.

No license, express or implied, by estoppel or otherwise, to any intellectual property rights is granted by this document or by any conduct of Vishay. Product names and markings noted herein may be trademarks of their respective owners.

## Material Category Policy

**Vishay Intertechnology, Inc. hereby certifies that all its products that are identified as RoHS-Compliant fulfill the definitions and restrictions defined under Directive 2011/65/EU of The European Parliament and of the Council of June 8, 2011 on the restriction of the use of certain hazardous substances in electrical and electronic equipment (EEE) - recast, unless otherwise specified as non-compliant.**

**Please note that some Vishay documentation may still make reference to RoHS Directive 2002/95/EC. We confirm that all the products identified as being compliant to Directive 2002/95/EC conform to Directive 2011/65/EU.**

**Vishay Intertechnology, Inc. hereby certifies that all its products that are identified as Halogen-Free follow Halogen-Free requirements as per JEDEC JS709A standards. Please note that some Vishay documentation may still make reference to the IEC 61249-2-21 definition. We confirm that all the products identified as being compliant to IEC 61249-2-21 conform to JEDEC JS709A standards.**