

FEATURES

- Member of the Texas Instruments Widebus™ Family
- DOC™ Circuitry Dynamically Changes Output Impedance, Resulting in Noise Reduction Without Speed Degradation
- Dynamic Drive Capability Is Equivalent to Standard Outputs With I_{OH} and I_{OL} of ± 24 mA at 2.5-V V_{CC}
- Control Inputs V_{IH}/V_{IL} Levels Are Referenced to V_{CCB} Voltage
- If Either V_{CC} Input Is at GND, Both Ports Are in the High-Impedance State
- Overvoltage-Tolerant Inputs/Outputs Allow Mixed-Voltage-Mode Data Communications
- I_{off} Supports Partial-Power-Down Mode Operation
- Fully Configurable Dual-Rail Design Allows Each Port to Operate Over Full 1.4-V to 3.6-V Power-Supply Range
- Latch-Up Performance Exceeds 100 mA Per JESD 78, Class II
- ESD Protection Exceeds JESD 22
 - 2000-V Human-Body Model (A114-A)
 - 200-V Machine Model (A115-A)
 - 1000-V Charged-Device Model (C101)

DESCRIPTION

This 16-bit (dual-octal) noninverting bus transceiver uses two separate configurable power-supply rails. The A port is designed to track V_{CCA} . V_{CCA} accepts any supply voltage from 1.4 V to 3.6 V. The B port is designed to track V_{CCB} . V_{CCB} accepts any supply voltage from 1.4 V to 3.6 V. This allows for universal low-voltage bidirectional translation between any of the 1.5-V, 1.8-V, 2.5-V, and 3.3-V voltage nodes.

The SN74AVCB164245 is designed for asynchronous communication between data buses. The device transmits data from the A bus to the B bus or from the B bus to the A bus, depending on the logic level at the direction-control (DIR) input. The output-enable (\overline{OE}) input can be used to disable the outputs so the buses are effectively isolated.

The SN74AVCB164245 is designed so that the control pins (1DIR, 2DIR, $1\overline{OE}$, and $2\overline{OE}$) are supplied by V_{CCB} .

To ensure the high-impedance state during power up or power down, \overline{OE} should be tied to V_{CCB} through a pullup resistor; the minimum value of the resistor is determined by the current-sinking capability of the driver.

This device is fully specified for partial-power-down applications using I_{off} . The I_{off} circuitry disables the outputs, preventing damaging current backflow through the device when it is powered down. If either V_{CC} input is at GND, both ports are in the high-impedance state.

ORDERING INFORMATION

T_A	PACKAGE ⁽¹⁾		ORDERABLE PART NUMBER	TOP-SIDE MARKING
–40°C to 85°C	FBGA – GRD	Tape and reel	74AVCB164245GRDR	WB4245
	FBGA – ZRD (Pb-Free)	Tape and reel	74AVCB164245ZRDR	
	TSSOP – DGG	Tape and reel	SN74AVCB164245GR	AVCB164245
	TVSOP – DGV	Tape and reel	SN74AVCB164245VR	WB4245
	VFBGA – GQL	Tape and reel	SN74AVCB164245KR	
	VFBGA – ZQL (Pb-Free)	Tape and reel	74AVCB164245ZQLR	

(1) Package drawings, standard packing quantities, thermal data, symbolization, and PCB design guidelines are available at www.ti.com/sc/package.



Please be aware that an important notice concerning availability, standard warranty, and use in critical applications of Texas Instruments semiconductor products and disclaimers thereto appears at the end of this data sheet.

Widebus, DOC are trademarks of Texas Instruments.

SN74AVCB164245
16-BIT DUAL-SUPPLY BUS TRANSCEIVER
WITH CONFIGURABLE VOLTAGE TRANSLATION AND 3-STATE OUTPUTS

SCES394D–JUNE 2002–REVISED JUNE 2005

TERMINAL ASSIGNMENTS

DGG OR DGV PACKAGE
(TOP VIEW)

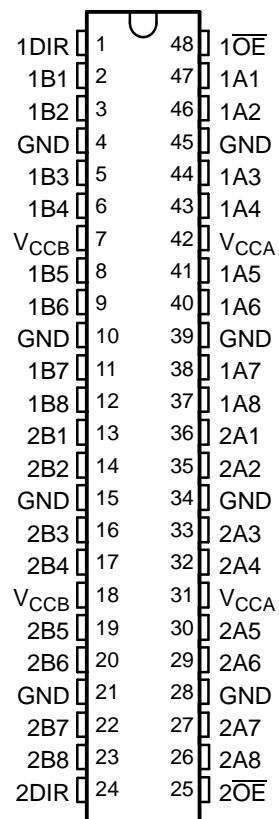

**GQL OR ZQL PACKAGE
(TOP VIEW)**

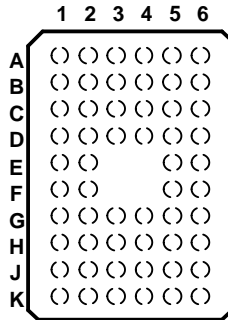

**TERMINAL ASSIGNMENTS
(56-Ball GQL/ZQL Package)⁽¹⁾**

	1	2	3	4	5	6
A	1DIR	NC	NC	NC	NC	1 \overline{OE}
B	1B2	1B1	GND	GND	1A1	1A2
C	1B4	1B3	V _{CCB}	V _{CCA}	1A3	1A4
D	1B6	1B5	GND	GND	1A5	1A6
E	1B8	1B7			1A7	1A8
F	2B1	2B2			2A2	2A1
G	2B3	2B4	GND	GND	2A4	2A3
H	2B5	2B6	V _{CCB}	V _{CCA}	2A6	2A5
J	2B7	2B8	GND	GND	2A8	2A7
K	2DIR	NC	NC	NC	NC	2 \overline{OE}

(1) NC - No internal connection

**GRD OR ZRD PACKAGE
(TOP VIEW)**

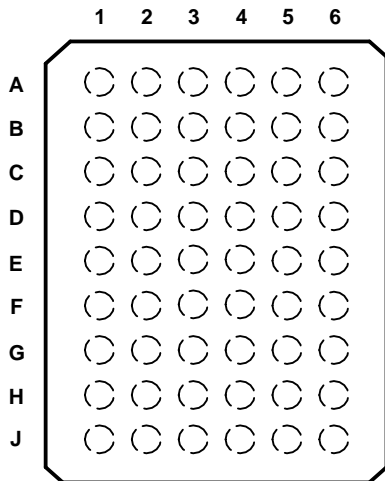

**TERMINAL ASSIGNMENTS
(54-Ball GRD/ZRD Package)⁽¹⁾**

	1	2	3	4	5	6
A	1B1	NC	1DIR	1 \overline{OE}	NC	1A1
B	1B3	1B2	NC	NC	1A2	1A3
C	1B5	1B4	V _{CCB}	V _{CCA}	1A4	1A5
D	1B7	1B6	GND	GND	1A6	1A7
E	2B1	1B8	GND	GND	1A8	2A1
F	2B3	2B2	GND	GND	2A2	2A3
G	2B5	2B4	V _{CCB}	V _{CCA}	2A4	2A5
H	2B7	2B6	NC	NC	2A6	2A7
J	2B8	NC	2DIR	2 \overline{OE}	NC	2A8

(1) NC - No internal connection

**FUNCTION TABLE
(EACH 8-BIT SECTION)**

INPUTS		OPERATION
\overline{OE}	DIR	
L	L	B data to A bus
L	H	A data to B bus
H	X	Isolation

SN74AVCB164245

16-BIT DUAL-SUPPLY BUS TRANSCEIVER

WITH CONFIGURABLE VOLTAGE TRANSLATION AND 3-STATE OUTPUTS

SCES394D–JUNE 2002–REVISED JUNE 2005

LOGIC DIAGRAM (POSITIVE LOGIC)

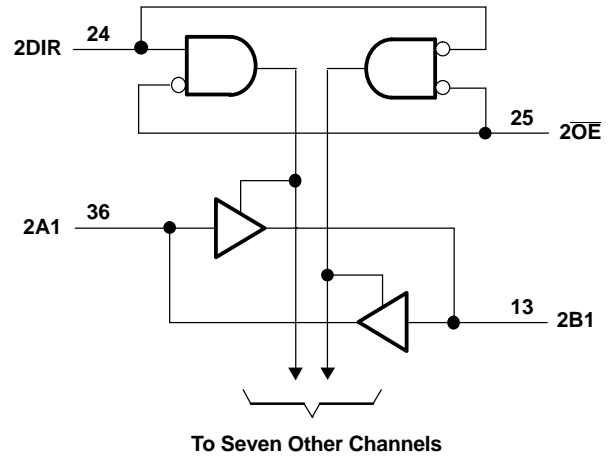

Pin numbers shown are for the DGG and DGV packages.

Absolute Maximum Ratings⁽¹⁾

over operating free-air temperature range (unless otherwise noted)

		MIN	MAX	UNIT	
V_{CCA} V_{CCB}	Supply voltage range	-0.5	4.6	V	
V_I	Input voltage range ⁽²⁾	I/O ports (A port)	-0.5	4.6	V
		I/O ports (B port)	-0.5	4.6	
		Control inputs	-0.5	4.6	
V_O	Voltage range applied to any output in the high-impedance or power-off state ⁽²⁾	A port	-0.5	4.6	V
		B port	-0.5	4.6	
V_O	Voltage range applied to any output in the high or low state ⁽²⁾⁽³⁾	A port	-0.5	$V_{CCA} + 0.5$	V
		B port	-0.5	$V_{CCB} + 0.5$	
I_{IK}	Input clamp current	$V_I < 0$	-50	mA	
I_{OK}	Output clamp current	$V_O < 0$	-50	mA	
I_O	Continuous output current		50	mA	
	Continuous current through V_{CCA} , V_{CCB} , or GND		100	mA	
θ_{JA}	Package thermal impedance ⁽⁴⁾	DGG package	70	°C/W	
		DGV package	58		
		GQL/ZQL package	28		
		GRD/ZRD package	36		
T_{stg}	Storage temperature range	-65	150	°C	

- (1) Stresses beyond those listed under "absolute maximum ratings" may cause permanent damage to the device. These are stress ratings only, and functional operation of the device at these or any other conditions beyond those indicated under "recommended operating conditions" is not implied. Exposure to absolute-maximum-rated conditions for extended periods may affect device reliability.
- (2) The input and output negative-voltage ratings may be exceeded if the input and output current ratings are observed.
- (3) The output positive-voltage rating may be exceeded up to 4.6 V maximum if the output current rating is observed.
- (4) The package thermal impedance is calculated in accordance with JESD 51-7.

Recommended Operating Conditions⁽¹⁾⁽²⁾⁽³⁾

over operating free-air temperature range (unless otherwise noted)

		V_{CCI}	V_{CCO}	MIN	MAX	UNIT
V_{CCA}	Supply voltage			1.4	3.6	V
V_{CCB}	Supply voltage			1.4	3.6	V
V_{IH}	High-level input voltage	Data inputs	1.4 V to 1.95 V		$V_{CCI} \times 0.65$	V
			1.95 V to 2.7 V		1.7	
			2.7 V to 3.6 V		2	
V_{IL}	Low-level input voltage	Data inputs	1.4 V to 1.95 V		$V_{CCI} \times 0.35$	V
			1.95 V to 2.7 V		0.7	
			2.7 V to 3.6 V		0.8	
V_{IH}	High-level input voltage	Control inputs (referenced to V_{CCB})	1.4 V to 1.95 V		$V_{CCB} \times 0.65$	V
			1.95 V to 2.7 V		1.7	
			2.7 V to 3.6 V		2	
V_{IL}	Low-level input voltage	Control inputs (referenced to V_{CCB})	1.4 V to 1.95 V		$V_{CCB} \times 0.35$	V
			1.95 V to 2.7 V		0.7	
			2.7 V to 3.6 V		0.8	
V_I	Input voltage			0	3.6	V
V_O	Output voltage	Active state		0	V_{CCO}	V
		3-state		0	3.6	
I_{OH}	High-level output current		1.4 V to 1.6 V		–2	mA
			1.65 V to 1.95 V		–4	
			2.3 V to 2.7 V		–8	
			3 V to 3.6 V		–12	
I_{OL}	Low-level output current		1.4 V to 1.6 V		2	mA
			1.65 V to 1.95 V		4	
			2.3 V to 2.7 V		8	
			3 V to 3.6 V		12	
$\Delta t/\Delta v$	Input transition rise or fall rate				5	ns/V
T_A	Operating free-air temperature			–40	85	°C

 (1) V_{CCI} is the V_{CC} associated with the data input port.

 (2) V_{CCO} is the V_{CC} associated with the data output port.

 (3) All unused data inputs of the device must be held at V_{CCI} or GND to ensure proper device operation. Refer to the TI application report, *Implications of Slow or Floating CMOS Inputs*, literature number SCBA004.

SN74AVCB164245
16-BIT DUAL-SUPPLY BUS TRANSCEIVER
WITH CONFIGURABLE VOLTAGE TRANSLATION AND 3-STATE OUTPUTS

SCES394D–JUNE 2002–REVISED JUNE 2005

Electrical Characteristics⁽¹⁾⁽²⁾

over operating free-air temperature range (unless otherwise noted)

PARAMETER		TEST CONDITIONS		V _{CCA}	V _{CCB}	MIN	TYP ⁽³⁾	MAX	UNIT
V _{OH}		I _{OH} = –100 μA	V _I = V _{IH}	1.4 V to 3.6 V	1.4 V to 3.6 V	V _{CCO} – 0.2			V
		I _{OH} = –2 mA	V _I = V _{IH}	1.4 V	1.4 V	1.05			
		I _{OH} = –4 mA	V _I = V _{IH}	1.65 V	1.65 V	1.2			
		I _{OH} = –8 mA	V _I = V _{IH}	2.3 V	2.3 V	1.75			
		I _{OH} = –12 mA	V _I = V _{IH}	3 V	3 V	2.3			
V _{OL}		I _{OH} = 100 μA	V _I = V _{IL}	1.4 V to 3.6 V	1.4 V to 3.6 V	0.2			V
		I _{OH} = 2 mA	V _I = V _{IL}	1.4 V	1.4 V	0.35			
		I _{OH} = 4 mA	V _I = V _{IL}	1.65 V	1.65 V	0.45			
		I _{OH} = 8 mA	V _I = V _{IL}	2.3 V	2.3 V	0.55			
		I _{OH} = 12 mA	V _I = V _{IL}	3 V	3 V	0.7			
I _I	Control inputs	V _I = V _{CCB} or GND		1.4 V to 3.6 V	3.6 V	±2.5			μA
I _{off}	A port	V _I or V _O = 0 to 3.6 V		0 V	0 to 3.6 V	±10			μA
	B port			0 to 3.6 V	0 V	±10			
I _{OZ} ⁽⁴⁾	A or B ports	V _O = V _{CCO} or GND, V _I = V _{CCI} or GND	$\overline{OE} = V_{IH}$	3.6 V	3.6 V	±12.5			μA
	B port		$\overline{OE} = \text{don't care}$	0 V	3.6 V	±12.5			
	A port			3.6 V	0 V	±12.5			
I _{CCA}	V _I = V _{CCI} or GND, I _O = 0			1.6 V	1.6 V	20			μA
				1.95 V	1.95 V	20			
				2.7 V	2.7 V	30			
				0 V	3.6 V	–40			
				3.6 V	0 V	40			
				3.6 V	3.6 V	40			
I _{CCB}	V _I = V _{CCI} or GND, I _O = 0			1.6 V	1.6 V	20			μA
				1.95 V	1.95 V	20			
				2.7 V	2.7 V	30			
				0 V	3.6 V	40			
				3.6 V	0 V	–40			
				3.6 V	3.6 V	40			
C _i	Control inputs	V _I = 3.3 V or GND		3.3 V	3.3 V	4			pF
C _{io}	A or B ports	V _O = 3.3 V or GND		3.3 V	3.3 V	5			pF

- (1) V_{CCO} is the V_{CC} associated with the output port.
- (2) V_{CCI} is the V_{CC} associated with the input port.
- (3) All typical values are at T_A = 25°C.
- (4) For I/O ports, the parameter I_{OZ} includes the input leakage current.

Switching Characteristics

over recommended operating free-air temperature range, $V_{CCA} = 1.5 \text{ V} \pm 0.1 \text{ V}$ (see [Figure 2](#))

PARAMETER	FROM (INPUT)	TO (OUTPUT)	$V_{CCB} = 1.5 \text{ V}$ 0.1 V		$V_{CCB} = 1.8 \text{ V}$ 0.15 V		$V_{CCB} = 2.5 \text{ V}$ 0.2 V		$V_{CCB} = 3.3 \text{ V}$ 0.3 V		UNIT
			MIN	MAX	MIN	MAX	MIN	MAX	MIN	MAX	
t_{pd}	A	B	1.7	6.7	1.9	6.3	1.8	5.5	1.7	5.8	ns
	B	A	1.8	6.8	2.2	7.4	2.1	7.6	2.1	7.3	
t_{en}	\overline{OE}	A	2.5	8.4	2.4	7.4	2.1	5.2	1.9	4.2	ns
		B	2.1	9	2.9	9.8	3.2	10	3	9.8	
t_{dis}	\overline{OE}	A	2.2	6.9	2.3	6.1	1.3	3.6	1.3	3	ns
		B	2.1	7.1	2.3	6.4	1.7	5.1	1.6	4.8	

Switching Characteristics

over recommended operating free-air temperature range, $V_{CCA} = 1.8 \text{ V} \pm 0.15 \text{ V}$ (see [Figure 2](#))

PARAMETER	FROM (INPUT)	TO (OUTPUT)	$V_{CCB} = 1.5 \text{ V}$ 0.1 V		$V_{CCB} = 1.8 \text{ V}$ 0.15 V		$V_{CCB} = 2.5 \text{ V}$ 0.2 V		$V_{CCB} = 3.3 \text{ V}$ 0.3 V		UNIT
			MIN	MAX	MIN	MAX	MIN	MAX	MIN	MAX	
t_{pd}	A	B	1.7	6.7	1.8	6	1.7	4.7	1.6	4.3	ns
	B	A	1.4	5.5	1.8	6	1.8	5.8	1.8	5.5	
t_{en}	\overline{OE}	A	2.6	8.5	2.5	7.5	2.2	5.3	1.9	4.2	ns
		B	1.8	7.6	2.6	7.7	2.6	7.6	2.6	7.4	
t_{dis}	\overline{OE}	A	2.3	7	2.3	6.1	1.3	3.6	1.3	3	ns
		B	1.8	7	2.5	6.3	1.8	4.7	1.7	4.4	

Switching Characteristics

over recommended operating free-air temperature range, $V_{CCA} = 2.5 \text{ V} \pm 0.2 \text{ V}$ (see [Figure 2](#))

PARAMETER	FROM (INPUT)	TO (OUTPUT)	$V_{CCB} = 1.5 \text{ V}$ 0.1 V		$V_{CCB} = 1.8 \text{ V}$ 0.15 V		$V_{CCB} = 2.5 \text{ V}$ 0.2 V		$V_{CCB} = 3.3 \text{ V}$ 0.3 V		UNIT
			MIN	MAX	MIN	MAX	MIN	MAX	MIN	MAX	
t_{pd}	A	B	1.6	6	1.8	5.6	1.5	4	1.4	3.4	ns
	B	A	1.3	4.6	1.7	4.4	1.5	4	1.4	3.7	
t_{en}	\overline{OE}	A	3.1	8.5	2.5	7.5	2.2	5.3	1.9	4.2	ns
		B	1.7	5.7	2.2	5.5	2.2	5.3	2.2	5.1	
t_{dis}	\overline{OE}	A	2.4	7	3	6.1	1.4	3.6	1.2	3	ns
		B	1.2	5.8	1.9	5	1.4	3.6	1.3	3.3	

Switching Characteristics

over recommended operating free-air temperature range, $V_{CCA} = 3.3 \text{ V} \pm 0.3 \text{ V}$ (see [Figure 2](#))

PARAMETER	FROM (INPUT)	TO (OUTPUT)	$V_{CCB} = 1.5 \text{ V}$ 0.1 V		$V_{CCB} = 1.8 \text{ V}$ 0.15 V		$V_{CCB} = 2.5 \text{ V}$ 0.2 V		$V_{CCB} = 3.3 \text{ V}$ 0.3 V		UNIT
			MIN	MAX	MIN	MAX	MIN	MAX	MIN	MAX	
t_{pd}	A	B	1.5	5.9	1.7	5.4	1.5	3.7	1.4	3.1	ns
	B	A	1.3	4.5	1.6	3.8	1.5	3.3	1.4	3.1	
t_{en}	\overline{OE}	A	2.6	8.3	2.5	7.4	2.2	5.2	1.9	4.1	ns
		B	1.6	4.9	2	4.5	2	4.3	1.9	4.1	
t_{dis}	\overline{OE}	A	2.3	7	3	6	1.3	3.5	1.2	3.5	ns
		B	1.3	6.9	2.1	5.5	1.6	3.8	1.5	3.5	

SN74AVCB164245
16-BIT DUAL-SUPPLY BUS TRANSCEIVER
WITH CONFIGURABLE VOLTAGE TRANSLATION AND 3-STATE OUTPUTS

SCES394D–JUNE 2002–REVISED JUNE 2005

Operating Characteristics

V_{CCA} and $V_{CCB} = 3.3\text{ V}$, $T_A = 25^\circ\text{C}$

PARAMETER		TEST CONDITIONS	TYP	UNIT
C_{pdA} (V_{CCA})	Power dissipation capacitance per transceiver, A-port input, B-port output	Outputs enabled	14	pF
		Outputs disabled	7	
	Power dissipation capacitance per transceiver, B-port input, A-port output	Outputs enabled	20	
		Outputs disabled	7	
C_{pdB} (V_{CCB})	Power dissipation capacitance per transceiver, A-port input, B-port output	Outputs enabled	20	pF
		Outputs disabled	7	
	Power dissipation capacitance per transceiver, B-port input, A-port output	Outputs enabled	14	
		Outputs disabled	7	

Output Description

The DOC™ circuitry is implemented, which, during the transition, initially lowers the output impedance to effectively drive the load and, subsequently, raises the impedance to reduce noise. Figure 1 shows typical V_{OL} vs I_{OL} and V_{OH} vs I_{OH} curves to illustrate the output impedance and drive capability of the circuit. At the beginning of the signal transition, the DOC circuit provides a maximum dynamic drive that is equivalent to a high-drive standard-output device. For more information, refer to the TI application reports, *AVC Logic Family Technology and Applications*, literature number SCEA006, and *Dynamic Output Control (DOC™) Circuitry Technology and Applications*, literature number SCEA009.

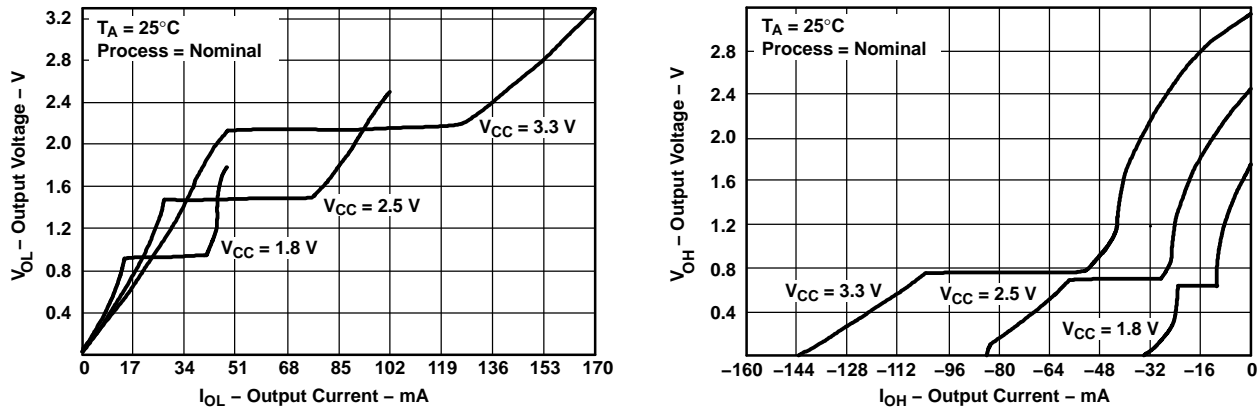
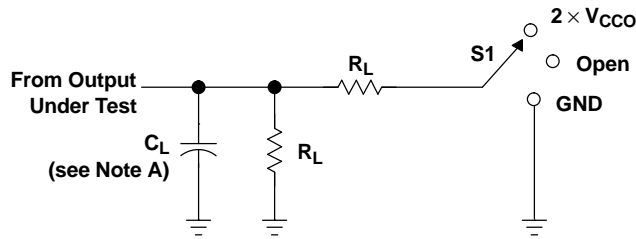

Figure 1. Typical Output Voltage vs Output Current

PARAMETER MEASUREMENT INFORMATION



LOAD CIRCUIT

TEST	S1
t_{pd}	Open
t_{PLZ}/t_{PZL}	$2 \times V_{CCO}$
t_{PHZ}/t_{PZH}	GND

V_{CCO}	C_L	R_L	V_{TP}
$1.5\text{ V} \pm 0.1\text{ V}$	15 pF	2 k Ω	0.1 V
$1.8\text{ V} \pm 0.15\text{ V}$	30 pF	1 k Ω	0.15 V
$2.5\text{ V} \pm 0.2\text{ V}$	30 pF	500 Ω	0.15 V
$3.3\text{ V} \pm 0.3\text{ V}$	30 pF	500 Ω	0.3 V

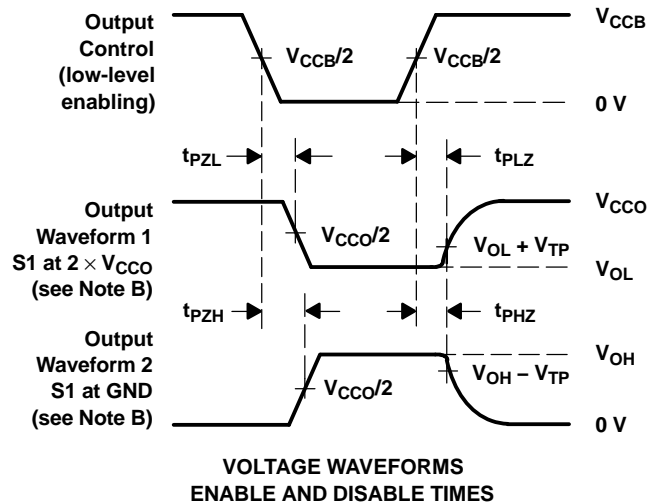
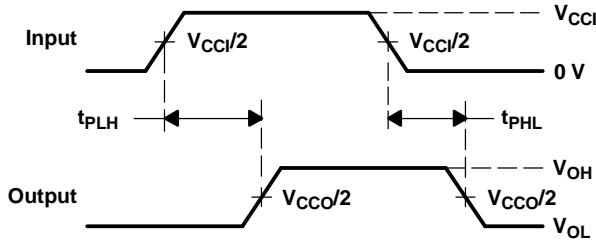
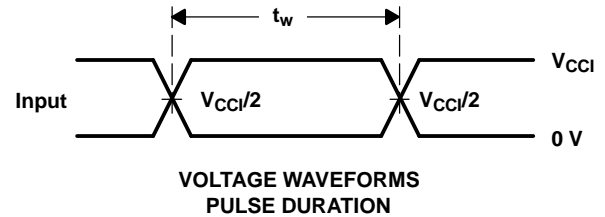

- NOTES: A. C_L includes probe and jig capacitance.
 B. Waveform 1 is for an output with internal conditions such that the output is low, except when disabled by the output control. Waveform 2 is for an output with internal conditions such that the output is high, except when disabled by the output control.
 C. All input pulses are supplied by generators having the following characteristics: $PRR \leq 10\text{ MHz}$, $Z_O = 50\ \Omega$, $dv/dt \geq 1\text{ V/ns}$.
 D. The outputs are measured one at a time, with one transition per measurement.
 E. t_{PLZ} and t_{PHZ} are the same as t_{dis} .
 F. t_{PZL} and t_{PZH} are the same as t_{en} .
 G. t_{PLH} and t_{PHL} are the same as t_{pd} .
 H. V_{CCi} is the V_{CC} associated with the input port.
 I. V_{CCO} is the V_{CC} associated with the output port.

Figure 2. Load Circuit and Voltage Waveforms

PACKAGING INFORMATION

Orderable Device	Status (1)	Package Type	Package Drawing	Pins	Package Qty	Eco Plan (2)	Lead/Ball Finish (6)	MSL Peak Temp (3)	Op Temp (°C)	Device Marking (4/5)	Samples
74AVCB164245GRDR	OBSOLETE	BGA MICROSTAR JUNIOR	GRD	54		TBD	Call TI	Call TI	-40 to 85		
74AVCB164245GRE4	ACTIVE	TSSOP	DGG	48	2000	Green (RoHS & no Sb/Br)	CU NIPDAU	Level-1-260C-UNLIM	-40 to 85	AVCB164245	Samples
74AVCB164245GRG4	ACTIVE	TSSOP	DGG	48	2000	Green (RoHS & no Sb/Br)	CU NIPDAU	Level-1-260C-UNLIM	-40 to 85	AVCB164245	Samples
74AVCB164245VRE4	ACTIVE	TVSOP	DGV	48	2000	Green (RoHS & no Sb/Br)	CU NIPDAU	Level-1-260C-UNLIM	-40 to 85	WB4245	Samples
74AVCB164245ZQLR	ACTIVE	BGA MICROSTAR JUNIOR	ZQL	56	1000	Green (RoHS & no Sb/Br)	SNAGCU	Level-1-260C-UNLIM	-40 to 85	WB4245	Samples
74AVCB164245ZRDR	ACTIVE	BGA MICROSTAR JUNIOR	ZRD	54	1000	Green (RoHS & no Sb/Br)	SNAGCU	Level-1-260C-UNLIM	-40 to 85	WB4245	Samples
SN74AVCB164245GR	ACTIVE	TSSOP	DGG	48	2000	Green (RoHS & no Sb/Br)	CU NIPDAU	Level-1-260C-UNLIM	-40 to 85	AVCB164245	Samples
SN74AVCB164245KR	OBSOLETE	BGA MICROSTAR JUNIOR	GQL	56		TBD	Call TI	Call TI	-40 to 85	WB4245	
SN74AVCB164245VR	ACTIVE	TVSOP	DGV	48	2000	Green (RoHS & no Sb/Br)	CU NIPDAU	Level-1-260C-UNLIM	-40 to 85	WB4245	Samples

(1) The marketing status values are defined as follows:

ACTIVE: Product device recommended for new designs.

LIFEBUY: TI has announced that the device will be discontinued, and a lifetime-buy period is in effect.

NRND: Not recommended for new designs. Device is in production to support existing customers, but TI does not recommend using this part in a new design.

PREVIEW: Device has been announced but is not in production. Samples may or may not be available.

OBSOLETE: TI has discontinued the production of the device.

(2) Eco Plan - The planned eco-friendly classification: Pb-Free (RoHS), Pb-Free (RoHS Exempt), or Green (RoHS & no Sb/Br) - please check <http://www.ti.com/productcontent> for the latest availability information and additional product content details.

TBD: The Pb-Free/Green conversion plan has not been defined.

Pb-Free (RoHS): TI's terms "Lead-Free" or "Pb-Free" mean semiconductor products that are compatible with the current RoHS requirements for all 6 substances, including the requirement that lead not exceed 0.1% by weight in homogeneous materials. Where designed to be soldered at high temperatures, TI Pb-Free products are suitable for use in specified lead-free processes.

Pb-Free (RoHS Exempt): This component has a RoHS exemption for either 1) lead-based flip-chip solder bumps used between the die and package, or 2) lead-based die adhesive used between the die and leadframe. The component is otherwise considered Pb-Free (RoHS compatible) as defined above.

Green (RoHS & no Sb/Br): TI defines "Green" to mean Pb-Free (RoHS compatible), and free of Bromine (Br) and Antimony (Sb) based flame retardants (Br or Sb do not exceed 0.1% by weight in homogeneous material)

(3) MSL, Peak Temp. - The Moisture Sensitivity Level rating according to the JEDEC industry standard classifications, and peak solder temperature.

(4) There may be additional marking, which relates to the logo, the lot trace code information, or the environmental category on the device.

(5) Multiple Device Markings will be inside parentheses. Only one Device Marking contained in parentheses and separated by a "~" will appear on a device. If a line is indented then it is a continuation of the previous line and the two combined represent the entire Device Marking for that device.

(6) Lead/Ball Finish - Orderable Devices may have multiple material finish options. Finish options are separated by a vertical ruled line. Lead/Ball Finish values may wrap to two lines if the finish value exceeds the maximum column width.

Important Information and Disclaimer: The information provided on this page represents TI's knowledge and belief as of the date that it is provided. TI bases its knowledge and belief on information provided by third parties, and makes no representation or warranty as to the accuracy of such information. Efforts are underway to better integrate information from third parties. TI has taken and continues to take reasonable steps to provide representative and accurate information but may not have conducted destructive testing or chemical analysis on incoming materials and chemicals. TI and TI suppliers consider certain information to be proprietary, and thus CAS numbers and other limited information may not be available for release.

In no event shall TI's liability arising out of such information exceed the total purchase price of the TI part(s) at issue in this document sold by TI to Customer on an annual basis.

OTHER QUALIFIED VERSIONS OF SN74AVCB164245 :

- Automotive: [SN74AVCB164245-Q1](#)
- Enhanced Product: [SN74AVCB164245-EP](#)

NOTE: Qualified Version Definitions:

- Automotive - Q100 devices qualified for high-reliability automotive applications targeting zero defects
- Enhanced Product - Supports Defense, Aerospace and Medical Applications

TAPE AND REEL INFORMATION

QUADRANT ASSIGNMENTS FOR PIN 1 ORIENTATION IN TAPE

*All dimensions are nominal

Device	Package Type	Package Drawing	Pins	SPQ	Reel Diameter (mm)	Reel Width W1 (mm)	A0 (mm)	B0 (mm)	K0 (mm)	P1 (mm)	W (mm)	Pin1 Quadrant
74AVCB164245ZQLR	BGA MICROSTAR JUNIOR	ZQL	56	1000	330.0	16.4	4.8	7.3	1.5	8.0	16.0	Q1
74AVCB164245ZRDR	BGA MICROSTAR JUNIOR	ZRD	54	1000	330.0	16.4	5.8	8.3	1.55	8.0	16.0	Q1
SN74AVCB164245GR	TSSOP	DGG	48	2000	330.0	24.4	8.6	15.8	1.8	12.0	24.0	Q1
SN74AVCB164245VR	TVSOP	DGV	48	2000	330.0	16.4	7.1	10.2	1.6	12.0	16.0	Q1

TAPE AND REEL BOX DIMENSIONS

*All dimensions are nominal

Device	Package Type	Package Drawing	Pins	SPQ	Length (mm)	Width (mm)	Height (mm)
74AVCB164245ZQLR	BGA MICROSTAR JUNIOR	ZQL	56	1000	336.6	336.6	28.6
74AVCB164245ZRDR	BGA MICROSTAR JUNIOR	ZRD	54	1000	336.6	336.6	28.6
SN74AVCB164245GR	TSSOP	DGG	48	2000	367.0	367.0	45.0
SN74AVCB164245VR	TVSOP	DGV	48	2000	367.0	367.0	38.0

ZQL (R-PBGA-N56)

PLASTIC BALL GRID ARRAY

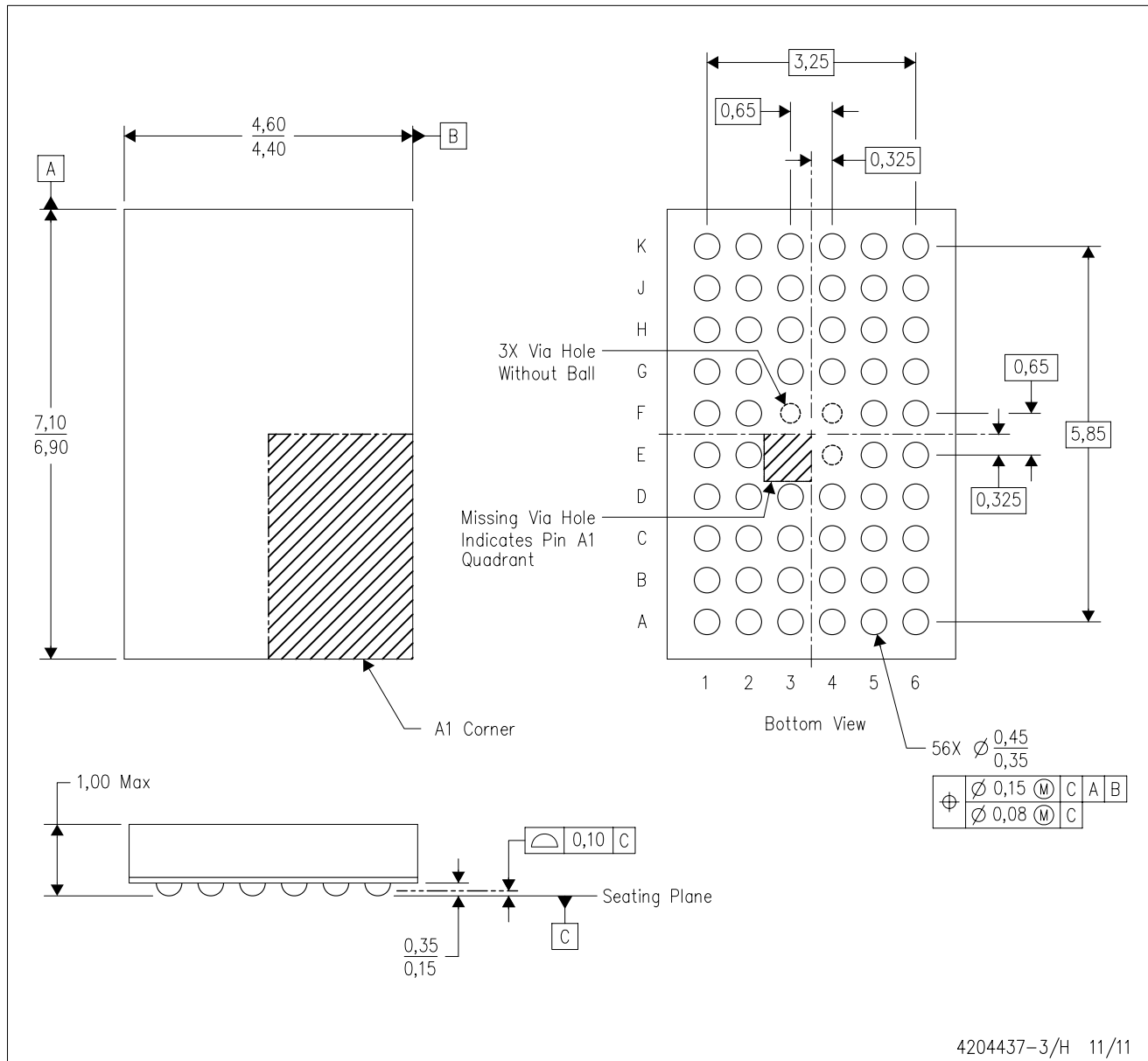

- NOTES:
- A. All linear dimensions are in millimeters. Dimensioning and tolerancing per ASME Y14.5M-1994.
 - B. This drawing is subject to change without notice.
 - C. Falls within JEDEC MO-285 variation BA-2.
 - D. This package is Pb-free. Refer to the 56 GQL package (drawing 4200583) for tin-lead (SnPb).

GRD (R-PBGA-N54)

PLASTIC BALL GRID ARRAY

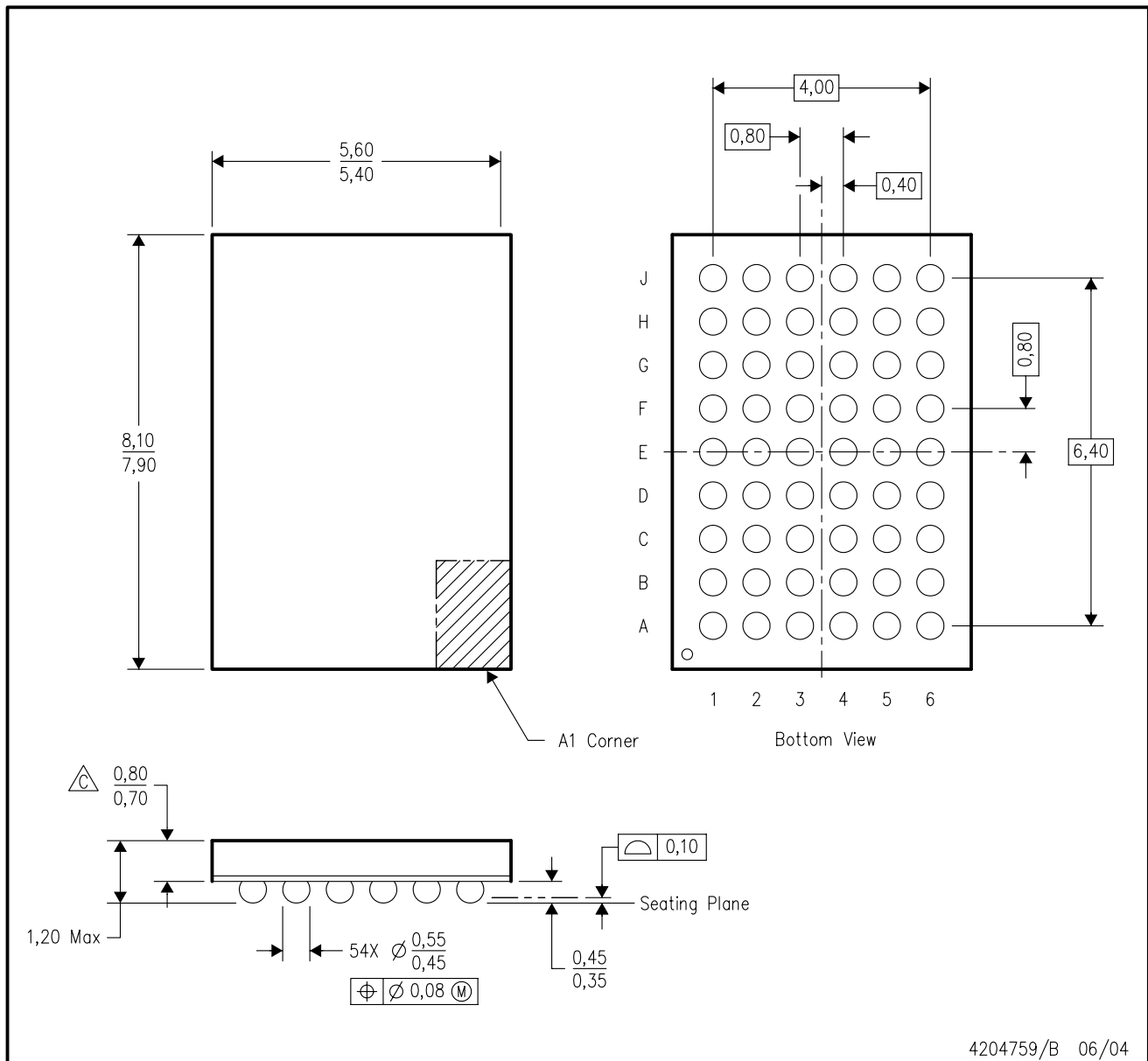

- NOTES:
- A. All linear dimensions are in millimeters.
 - B. This drawing is subject to change without notice.
 - $\triangle C$ Falls within JEDEC MO-205 variation DD.
 - D. This package is tin-lead (SnPb). Refer to the 54 ZRD package (drawing 4204760) for lead-free.

ZRD (R-PBGA-N54)

PLASTIC BALL GRID ARRAY

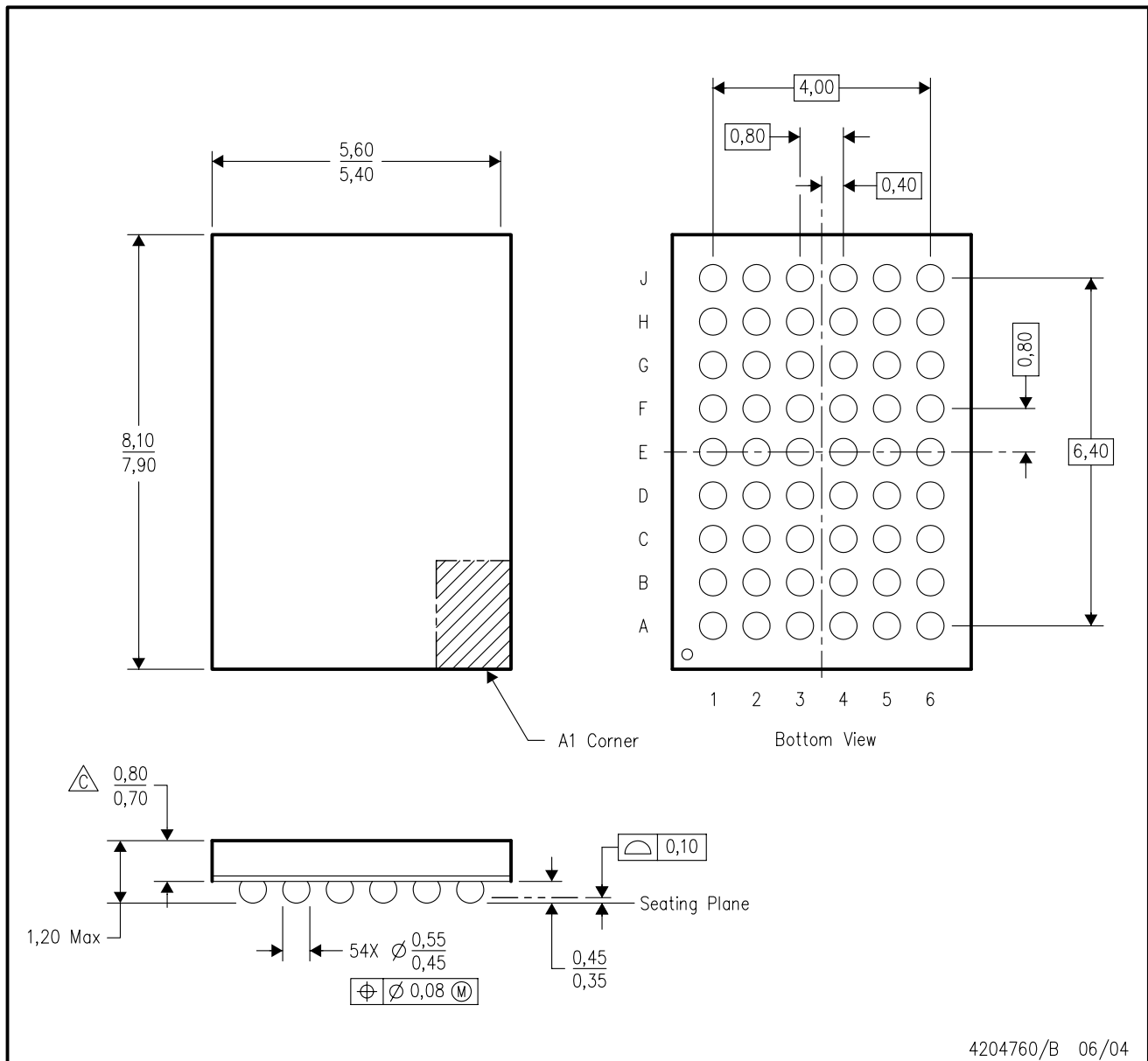

- NOTES:
- A. All linear dimensions are in millimeters.
 - B. This drawing is subject to change without notice.
 -  Falls within JEDEC MO-205 variation DD.
 - D. This package is lead-free. Refer to the 54 GRD package (drawing 4204759) for tin-lead (SnPb).

DGV (R-PDSO-G**)

PLASTIC SMALL-OUTLINE

24 PINS SHOWN



- NOTES: A. All linear dimensions are in millimeters.
 B. This drawing is subject to change without notice.
 C. Body dimensions do not include mold flash or protrusion, not to exceed 0,15 per side.
 D. Falls within JEDEC: 24/48 Pins – MO-153
 14/16/20/56 Pins – MO-194

GQL (R-PBGA-N56)

PLASTIC BALL GRID ARRAY

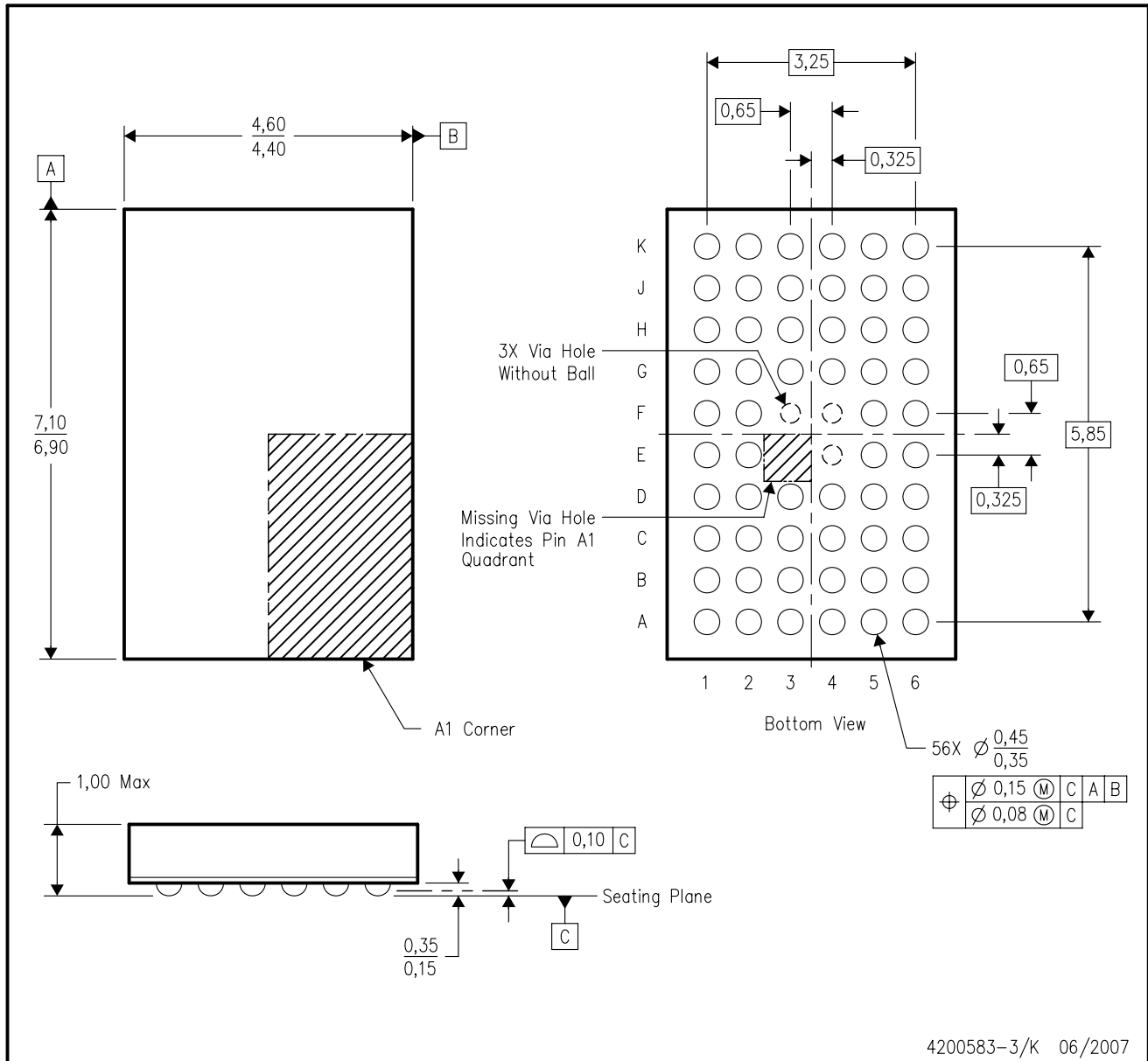

- NOTES:
- A. All linear dimensions are in millimeters. Dimensioning and tolerancing per ASME Y14.5M-1994.
 - B. This drawing is subject to change without notice.
 - C. Falls within JEDEC MO-285 variation BA-2.
 - D. This package is tin-lead (SnPb). Refer to the 56 ZQL package (drawing 4204437) for lead-free.

DGG (R-PDSO-G**)

PLASTIC SMALL-OUTLINE PACKAGE

48 PINS SHOWN



- NOTES: A. All linear dimensions are in millimeters.
 B. This drawing is subject to change without notice.
 C. Body dimensions do not include mold protrusion not to exceed 0,15.
 D. Falls within JEDEC MO-153

IMPORTANT NOTICE

Texas Instruments Incorporated and its subsidiaries (TI) reserve the right to make corrections, enhancements, improvements and other changes to its semiconductor products and services per JESD46, latest issue, and to discontinue any product or service per JESD48, latest issue. Buyers should obtain the latest relevant information before placing orders and should verify that such information is current and complete. All semiconductor products (also referred to herein as "components") are sold subject to TI's terms and conditions of sale supplied at the time of order acknowledgment.

TI warrants performance of its components to the specifications applicable at the time of sale, in accordance with the warranty in TI's terms and conditions of sale of semiconductor products. Testing and other quality control techniques are used to the extent TI deems necessary to support this warranty. Except where mandated by applicable law, testing of all parameters of each component is not necessarily performed.

TI assumes no liability for applications assistance or the design of Buyers' products. Buyers are responsible for their products and applications using TI components. To minimize the risks associated with Buyers' products and applications, Buyers should provide adequate design and operating safeguards.

TI does not warrant or represent that any license, either express or implied, is granted under any patent right, copyright, mask work right, or other intellectual property right relating to any combination, machine, or process in which TI components or services are used. Information published by TI regarding third-party products or services does not constitute a license to use such products or services or a warranty or endorsement thereof. Use of such information may require a license from a third party under the patents or other intellectual property of the third party, or a license from TI under the patents or other intellectual property of TI.

Reproduction of significant portions of TI information in TI data books or data sheets is permissible only if reproduction is without alteration and is accompanied by all associated warranties, conditions, limitations, and notices. TI is not responsible or liable for such altered documentation. Information of third parties may be subject to additional restrictions.

Resale of TI components or services with statements different from or beyond the parameters stated by TI for that component or service voids all express and any implied warranties for the associated TI component or service and is an unfair and deceptive business practice. TI is not responsible or liable for any such statements.

Buyer acknowledges and agrees that it is solely responsible for compliance with all legal, regulatory and safety-related requirements concerning its products, and any use of TI components in its applications, notwithstanding any applications-related information or support that may be provided by TI. Buyer represents and agrees that it has all the necessary expertise to create and implement safeguards which anticipate dangerous consequences of failures, monitor failures and their consequences, lessen the likelihood of failures that might cause harm and take appropriate remedial actions. Buyer will fully indemnify TI and its representatives against any damages arising out of the use of any TI components in safety-critical applications.

In some cases, TI components may be promoted specifically to facilitate safety-related applications. With such components, TI's goal is to help enable customers to design and create their own end-product solutions that meet applicable functional safety standards and requirements. Nonetheless, such components are subject to these terms.

No TI components are authorized for use in FDA Class III (or similar life-critical medical equipment) unless authorized officers of the parties have executed a special agreement specifically governing such use.

Only those TI components which TI has specifically designated as military grade or "enhanced plastic" are designed and intended for use in military/aerospace applications or environments. Buyer acknowledges and agrees that any military or aerospace use of TI components which have **not** been so designated is solely at the Buyer's risk, and that Buyer is solely responsible for compliance with all legal and regulatory requirements in connection with such use.

TI has specifically designated certain components as meeting ISO/TS16949 requirements, mainly for automotive use. In any case of use of non-designated products, TI will not be responsible for any failure to meet ISO/TS16949.

Products

Audio	www.ti.com/audio
Amplifiers	amplifier.ti.com
Data Converters	dataconverter.ti.com
DLP® Products	www.dlp.com
DSP	dsp.ti.com
Clocks and Timers	www.ti.com/clocks
Interface	interface.ti.com
Logic	logic.ti.com
Power Mgmt	power.ti.com
Microcontrollers	microcontroller.ti.com
RFID	www.ti-rfid.com
OMAP Applications Processors	www.ti.com/omap
Wireless Connectivity	www.ti.com/wirelessconnectivity

Applications

Automotive and Transportation	www.ti.com/automotive
Communications and Telecom	www.ti.com/communications
Computers and Peripherals	www.ti.com/computers
Consumer Electronics	www.ti.com/consumer-apps
Energy and Lighting	www.ti.com/energy
Industrial	www.ti.com/industrial
Medical	www.ti.com/medical
Security	www.ti.com/security
Space, Avionics and Defense	www.ti.com/space-avionics-defense
Video and Imaging	www.ti.com/video

TI E2E Community

e2e.ti.com