

## FLATLINK™ TRANSMITTER

Check for Samples: [SN75LVDS83A](#)

### FEATURES

- LVDS Display Serdes Interfaces Directly to LCD Display Panels with Integrated LVDS
- Package Options: 8.1mm x 14mm TSSOP
- 3.3V Tolerant Data Inputs
- Transfer Rate up to 100Mpps (Mega Pixel Per Second); Pixel Clock Frequency Range 10MHz to 100MHz
- Suited for Display Resolutions Ranging From HVGA up to HD With Low EMI
- Operates From a Single 3.3V Supply and 170mW (typ.) at 75MHz
- 28 Data Channels Plus Clock In Low-Voltage TTL to 4 Data Channels Plus Clock Out

### Low-Voltage Differential

- Consumes Less Than 1mW When Disabled
- Selectable Rising or Falling Clock Edge Triggered Inputs
- ESD: 5kV HBM
- Support Spread Spectrum Clocking (SSC)
- Compatible with all OMAP™2x, OMAP™3x, and DaVinci™ Application Processors

### APPLICATIONS

- LCD Display Panel Driver
- UMPC and Netbook PC
- Digital Picture Frame

### DESCRIPTION

The SN75LVDS83A FlatLink™ transmitter contains four 7-bit parallel-load serial-out shift registers, a 7X clock synthesizer, and five Low-Voltage Differential Signaling (LVDS) line drivers in a single integrated circuit. These functions allow 28 bits of single-ended LVTTTL data to be synchronously transmitted over five balanced-pair conductors for receipt by a compatible receiver, such as the SN75LVDS82 and LCD panels with integrated LVDS receiver.

When transmitting, data bits D0 through D27 are each loaded into registers upon the edge of the input clock signal (CLKIN). The rising or falling edge of the clock can be selected via the clock select (CLKSEL) pin. The frequency of CLKIN is multiplied seven times, and then used to unload the data registers in 7-bit slices and serially. The four serial streams and a phase-locked clock (CLKOUT) are then output to LVDS output drivers. The frequency of CLKOUT is the same as the input clock, CLKIN.

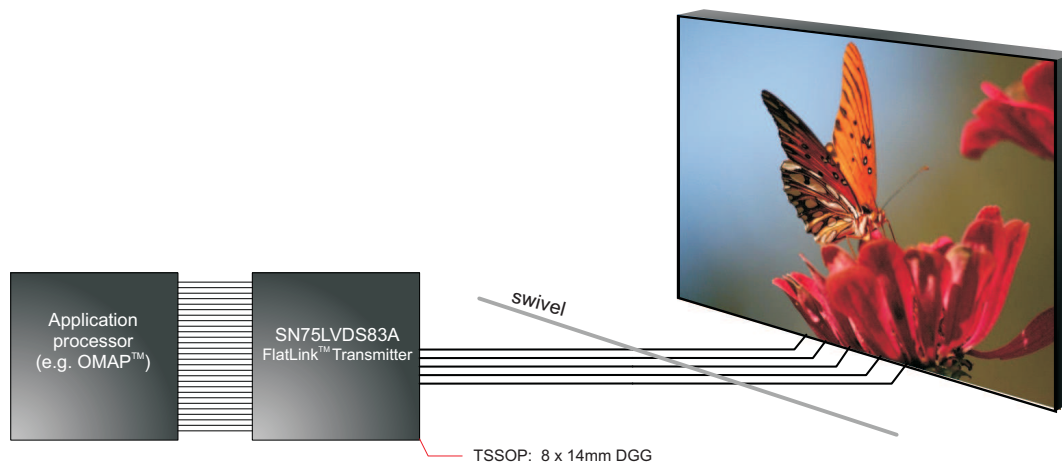

Please be aware that an important notice concerning availability, standard warranty, and use in critical applications of Texas Instruments semiconductor products and disclaimers thereto appears at the end of this data sheet.

OMAP, DaVinci, FlatLink are trademarks of Texas Instruments.

# SN75LVDS83A

SLLS980D – JUNE 2009 – REVISED JUNE 2011

[www.ti.com](http://www.ti.com)



This integrated circuit can be damaged by ESD. Texas Instruments recommends that all integrated circuits be handled with appropriate precautions. Failure to observe proper handling and installation procedures can cause damage.

ESD damage can range from subtle performance degradation to complete device failure. Precision integrated circuits may be more susceptible to damage because very small parametric changes could cause the device not to meet its published specifications.

## DESCRIPTION (CONTINUED)

The SN75LVDS83A requires no external components and little or no control. The data bus appears the same at the input to the transmitter and output of the receiver with the data transmission transparent to the user(s). The only user intervention is selecting a clock rising edge by inputting a high level to CLKSEL or a falling edge with a low-level input, and the possible use of the Shutdown/Clear (SHTDN). SHTDN is an active-low input to inhibit the clock, and shut off the LVDS output drivers for lower power consumption. A low-level on this signal clears all internal registers to a low-level.

The SN75LVDS83A is characterized for operation over ambient air temperatures of -10°C to 70°C.

Alternative device option: The SN75LVDS83B is an alternative to the SN75LVDS83A for clock frequency range of 10MHz–135MHz. The SN75LVDS83B is available in a smaller BGA package in addition to the TSSOP package.

## ORDERING INFORMATION<sup>(1)</sup>

PART NUMBER	PART MARKING	PACKAGE
SN75LVDS83ADGG	LVDS83A	56-pin DGG TUBE
SN75LVDS83ADGGR	LVDS83A	56-pin DGG LARGE T&R

(1) For the most current package and ordering information, see the Package Option Addendum located at the end of this data sheet, or refer to our web site at [www.ti.com](http://www.ti.com).

## ABSOLUTE MAXIMUM RATINGS<sup>(1)</sup>

	VALUE	UNIT
Supply voltage range, VCC, LVDSVCC, PLLVCC <sup>(2)</sup>	-0.5 to 4	V
Voltage range at any output terminal	-0.5 to VCC + 0.5	V
Voltage range at any input terminal	-0.5 to VCC + 0.5	V
Continuous power dissipation	See the Dissipation Rating Table	
ESD rating	Human Body Model (HBM) <sup>(3)</sup> all pins	5
	Charged Device Model (CDM) <sup>(4)</sup> all pins	500
	Machine Model (MM) <sup>(5)</sup> all pins	150

(1) Stresses above these ratings may cause permanent damage. Exposure to absolute maximum conditions for extended periods may degrade device reliability. These are stress ratings only, and functional operation of the device at these or any other conditions beyond those specified is not implied.

(2) All voltages are with respect to the GND terminals.

(3) In accordance with JEDEC Standard 22, Test Method A114-A.

(4) In accordance with JEDEC Standard 22, Test Method C101.

(5) In accordance with JEDEC Standard 22, Test Method A115-A.

## RECOMMENDED OPERATING CONDITIONS

over operating free-air temperature range (unless otherwise noted)

	MIN	NOM	MAX	UNIT
Supply voltage, VCC	3	3.3	3.6	V
LVDS output supply voltage, LVDSVCC	3	3.3	3.6	
PLL analog supply voltage, PLLVCC	3	3.3	3.6	
Power supply noise on any VCC terminal			0.1	
High-level input voltage, $V_{IH}$	$VCC/2 + 0.5$			V
Low-level input voltage, $V_{IL}$	$VCC/2 - 0.5$			V
Differential load impedance, $Z_L$	90		132	$\Omega$
Operating free-air temperature, $T_A$	-10		70	C

## DISSIPATION RATINGS

PACKAGE	CIRCUIT BOARD MODEL <sup>(1)</sup>	$T_{JA} \leq 25^\circ\text{C}$	DERATING FACTOR <sup>(2)</sup> ABOVE $T_{JA} = 25^\circ\text{C}$	$T_{JA} = 70^\circ\text{C}$ POWER RATING
DGG	Low-K	1111 mW	12.3mW/°C	555 mW
	High-K	1730 mW	19mW/°C	865 mW

(1) In accordance with the High-K and Low-K thermal metric definitions of EIA/JESD51-2.

(2) This is the inverse of the junction-to-ambient thermal resistance when board-mounted and with no air flow.

## TIMING REQUIREMENTS

PARAMETER	MIN	MAX	UNIT
Input clock period, $t_c$	10	100	ns
Input clock modulation (SSC)			
	w/ modulation frequency 30 kHz	8%	
	w/ modulation frequency 50 kHz	6%	
High-level input clock pulse width duration, $t_w$	$0.4 t_c$	$0.6 t_c$	ns
Input signal transition time, $t_t$		3	ns
Data set up time, D0 through D27 before CLKIN (See <a href="#">Figure 3</a> )	2		ns
Data hold time, D0 through D27 after CLKIN	0.8		ns

**SN75LVDS83A**

SLLS980D – JUNE 2009 – REVISED JUNE 2011

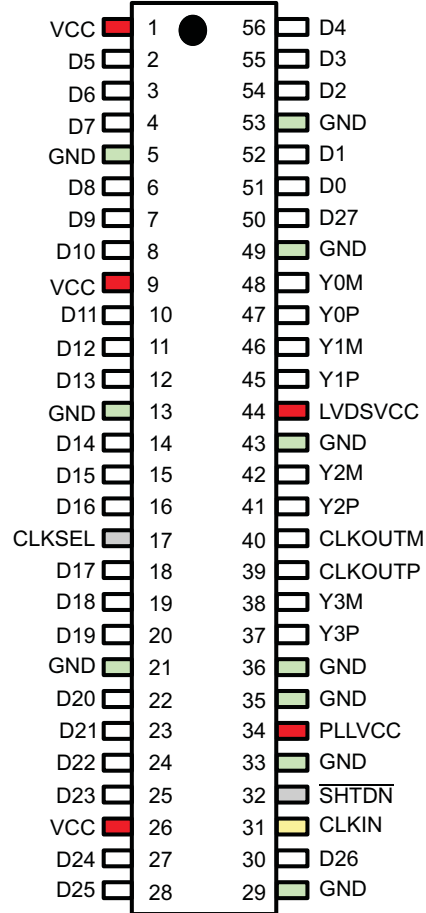
[www.ti.com](http://www.ti.com)
**DGG PACKAGE  
(TOP VIEW)**

**DGG PIN LIST**

Pin #	Signal	Pin #	Signal	Pin #	Signal	Pin #	Signal
1	VCC	15	D15	29	GND	43	GND
2	D5	16	D16	30	D26	44	LVDSVCC
3	D6	17	CLKSEL	31	CLKIN	45	Y1P
4	D7	18	D17	32	$\overline{\text{SHTDN}}$	46	Y1M
5	GND	19	D18	33	GND	47	Y0P
6	D8	20	D19	34	PLLVCC	48	Y0M
7	D9	21	GND	35	GND	49	GND
8	D10	22	D20	36	GND	50	D27
9	VCC	23	D21	37	Y3P	51	D0
10	D11	24	D22	38	Y3M	52	D1
11	D12	25	D23	39	CLKOUTP	53	GND
12	D13	26	VCC	40	CLKOUTM	54	D2
13	GND	27	D24	41	Y2P	55	D3
14	D14	28	D25	42	Y2M	56	D4

**PIN FUNCTIONS**

TERMINAL	I/O	DESCRIPTION
Y0P, Y0M, Y1P, Y1M, Y2P, Y2M	LVDS Out	Differential LVDS data outputs. Outputs are high-impedance when $\overline{\text{SHTDN}}$ is pulled low (de-asserted)
Y3P, Y3M		Differential LVDS Data outputs. Output is high-impedance when $\overline{\text{SHTDN}}$ is pulled low (de-asserted). Note: if the application only requires 18-bit color, this output can be left open.
CLKP, CLKM		Differential LVDS pixel clock output. Output is high-impedance when $\overline{\text{SHTDN}}$ is pulled low (de-asserted).
D0 – D27	CMOS IN with pulldn	Data inputs. To connect a graphic source successfully to a display, the bit assignment of D[27:0] is critical (and not necessarily intuitive). For input bit assignment see <a href="#">Figure 14</a> to <a href="#">Figure 17</a> for details. Note: if application only requires 18-bit color, connect unused inputs D5, D10, D11, D16, D17, D23, and D27 to GND.
CLKIN		Input pixel clock; rising or falling clock polarity is selectable by Control input CLKSEL.
$\overline{\text{SHTDN}}$		Device shut down; pull low (de-assert) to shut down the device (low power, resets all registers) and high (assert) for normal operation.
CLKSEL		Selects between rising edge input clock trigger (CLKSEL = $V_{IH}$ ) and falling edge input clock trigger (CLKSEL = $V_{IL}$ ).
VCC	Power Supply <sup>(1)</sup>	3.3V digital Supply Voltage
PLLVCC		3.3V PLL analog supply
LVDSVCC		3.3V LVDS output analog supply
GND		Supply Ground for VCC, LVDSVCC, and PLLVCC.

- (1) For a multilayer pcb, it is recommended to keep one common GND layer underneath the device and connect all ground terminals directly to this plane.

SN75LVDS83A

SLLS980D – JUNE 2009 – REVISED JUNE 2011

www.ti.com

FUNCTIONAL BLOCK DIAGRAM

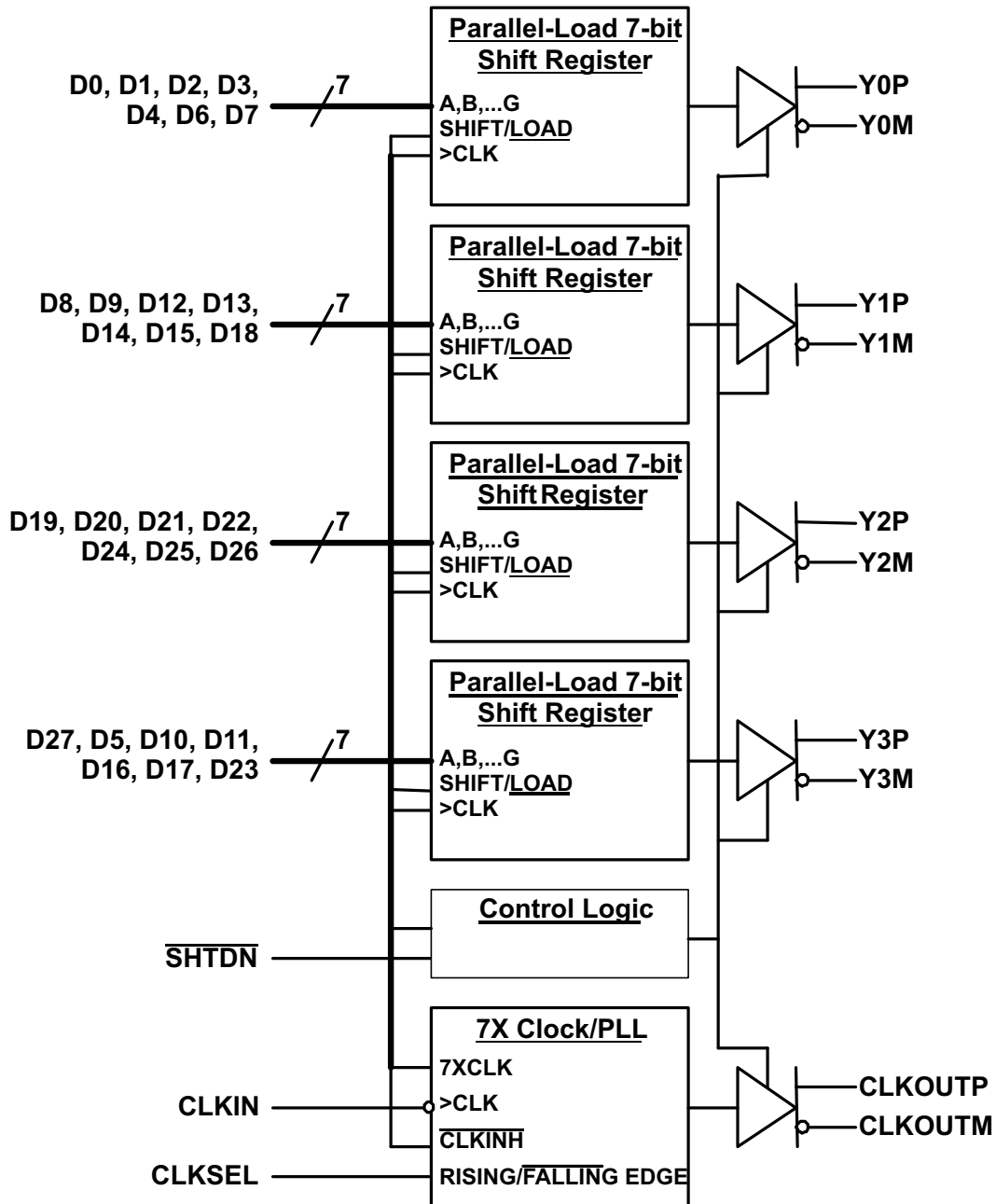

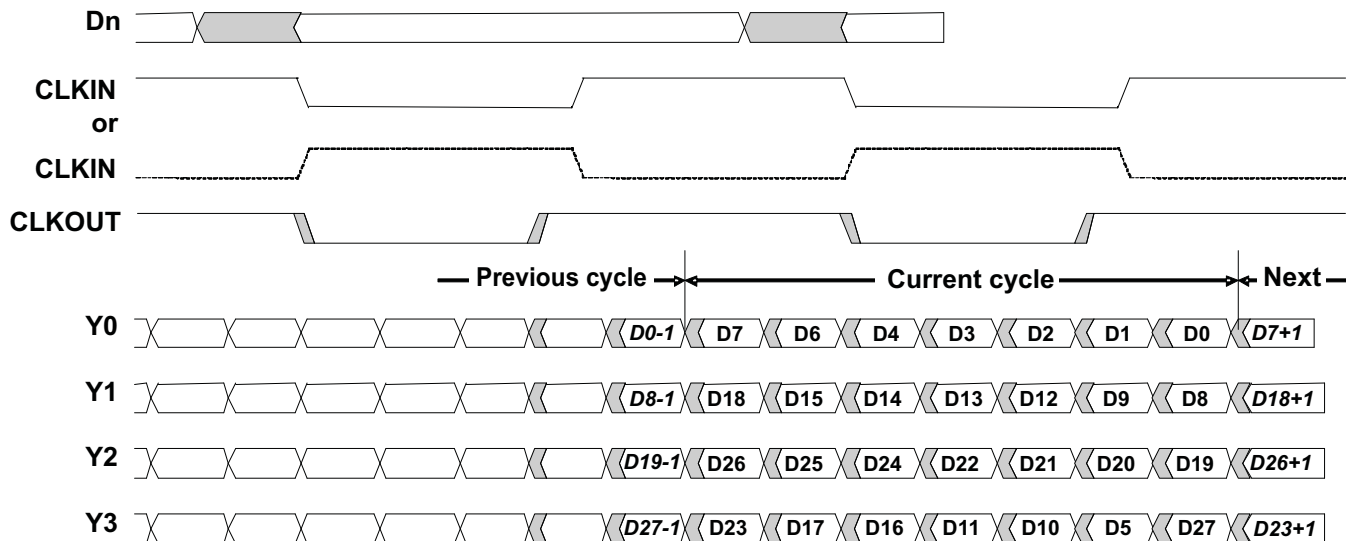

Figure 1. Typical SN75LVDS83A Load and Shift Sequences

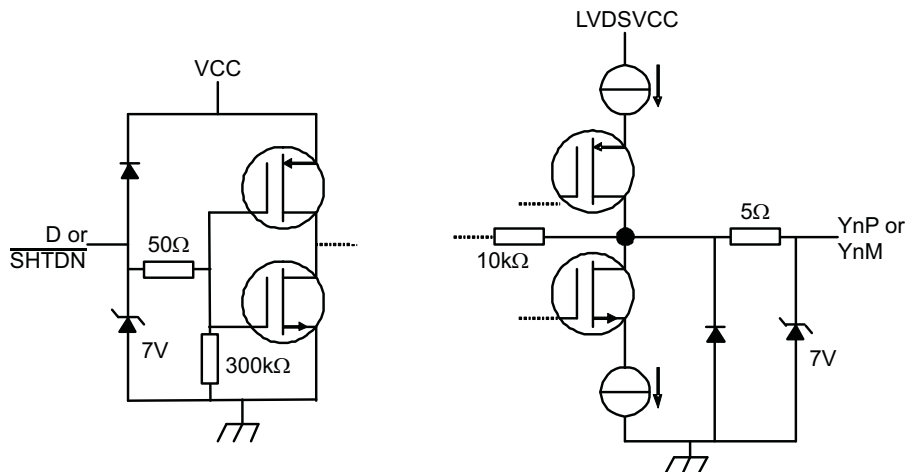

Figure 2. Equivalent Input and Output Schematic Diagrams

**SN75LVDS83A**

SLLS980D – JUNE 2009 – REVISED JUNE 2011

[www.ti.com](http://www.ti.com)
**ELECTRICAL CHARACTERISTICS**

over operating free-air temperature range (unless otherwise noted)

PARAMETER		TEST CONDITIONS	MIN	TYP <sup>(1)</sup>	MAX	UNIT
$V_T$	Input voltage threshold		VCC/2			V
$ V_{OD} $	Differential steady-state output voltage magnitude	$R_L = 100\Omega$ , See <a href="#">Figure 4</a>	250		450	mV
$\Delta V_{OD} $	Change in the steady-state differential output voltage magnitude between opposite binary states			1	35	mV
$V_{OC(SS)}$	Steady-state common-mode output voltage		1.125		1.375	V
$V_{OC(PP)}$	Peak-to-peak common-mode output voltage	See <a href="#">Figure 4</a> $t_{R/F} (Dx, CLKIN) = 1ns$			100	mV
$I_{IH}$	High-level input current	$V_{IH} = VCC$			25	$\mu A$
$I_{IL}$	Low-level input current	$V_{IL} = 0V$			$\pm 10$	$\mu A$
$I_{OS}$	Short-circuit output current	$V_{OY} = 0V$			$\pm 24$	mA
		$V_{OD} = 0V$			$\pm 12$	mA
$I_{OZ}$	High-impedance state output current	$V_O = 0V$ to VCC			$\pm 20$	$\mu A$
$R_{pdn}$	Input pull-down integrated resistor on all inputs (Dx, CLKSEL, SHTDN, CLKIN)			100		k $\Omega$
$I_Q$	Quiescent current	disabled, all inputs at GND; $SHTDN = V_{IL}$		2	100	$\mu A$
$I_{CC}$	Supply current (average)	$SHTDN = V_{IH}$ , $R_L = 100\Omega$ (5 places), grayscale pattern ( <a href="#">Figure 5</a> ) $VCC = 3.3V$ , $f_{CLK} = 75MHz$		52.3	62.2	mA
		$SHTDN = V_{IH}$ , $R_L = 100\Omega$ (5 places), 50% transition density pattern ( <a href="#">Figure 5</a> ), $VCC = 3.3V$ , $f_{CLK} = 75MHz$		53.9	67.1	mA
		$SHTDN = V_{IH}$ , $R_L = 100\Omega$ (5 places), worst-case pattern ( <a href="#">Figure 6</a> ), $VCC = 3.6V$ , $f_{CLK} = 75MHz$		65	79.3	mA
		$SHTDN = V_{IH}$ , $R_L = 100\Omega$ (5 places), worst-case pattern ( <a href="#">Figure 6</a> ), $f_{CLK} = 100MHz$			96.8	mA
$C_I$	Input capacitance			2		pF

 (1) All typical values are at VCC = 3.3 V, T<sub>A</sub> = 25°C.

## SWITCHING CHARACTERISTICS

over operating free-air temperature range (unless otherwise noted)

PARAMETER		TEST CONDITIONS	MIN	TYP <sup>(1)</sup>	MAX	UNIT
$t_0$	Delay time, CLKOUT $\uparrow$ after Yn valid (serial bit position 0, equal D1, D9, D20, D5)	See <a href="#">Figure 7</a> , $t_C = 10$ ns,  Input clock jitter  < 25 ps <sup>(2)</sup>	-0.1	0	0.1	ns
$t_1$	Delay time, CLKOUT $\uparrow$ after Yn valid (serial bit position 1, equal D0, D8, D19, D27)		$1/7 t_C - 0.1$		$1/7 t_C + 0.1$	ns
$t_2$	Delay time, CLKOUT $\uparrow$ after Yn valid (serial bit position 2, equal D7, D18, D26, D23)		$2/7 t_C - 0.1$		$2/7 t_C + 0.1$	ns
$t_3$	Delay time, CLKOUT $\uparrow$ after Yn valid (serial bit position 3; equal D6, D15, D25, D17)		$3/7 t_C - 0.1$		$3/7 t_C + 0.1$	ns
$t_4$	Delay time, CLKOUT $\uparrow$ after Yn valid (serial bit position 4, equal D4, D14, D24, D16)		$4/7 t_C - 0.1$		$4/7 t_C + 0.1$	ns
$t_5$	Delay time, CLKOUT $\uparrow$ after Yn valid (serial bit position 5, equal D3, D13, D22, D11)		$5/7 t_C - 0.1$		$5/7 t_C + 0.1$	ns
$t_6$	Delay time, CLKOUT $\uparrow$ after Yn valid (serial bit position 6, equal D2, D12, D21, D10)		$6/7 t_C - 0.1$		$6/7 t_C + 0.1$	ns
$t_{sk(o)}$	Output skew, $t_n - n/7 t_C$	Target Potential adjustment after char	-0.1 (-0.15)		0.1 (0.15)	ns
$t_7$	Delay time, CLKIN $\downarrow$ to CLKOUT $\downarrow$	$t_C = 10$ ns ( $\pm 0.2\%$ ),  Input clock jitter  < 50 ps, See <a href="#">Figure 7</a>		TBD		ns
$t_{c(o)}$	Output clock period			$t_C$		ns
$\Delta t_{c(o)}$	Output clock cycle-to-cycle jitter <sup>(3)</sup>	$t_C = 10$ ns; clean reference clock, see <a href="#">Figure 8</a>		$\pm 40$		ps
		$t_C = 10$ ns with 0.05UI added noise modulated at 3MHz, see <a href="#">Figure 8</a>		$\pm 44$		
		$t_C = 10$ ns with 0.1UI added noise modulated at 3MHz, see <a href="#">Figure 8</a>		$\pm 42$		
$t_w$	High-level output clock pulse duration			$4/7 t_C$		ns
$t_{r/f}$	Differential output voltage transition time ( $t_r$ or $t_f$ )	$f_{CLK}$ See <a href="#">Figure 4</a>		225	500	ps
$t_{en}$	Enable time, $\overline{SHTDN}$ $\uparrow$ to phase lock (Yn valid)	$f_{CLK} = 100$ MHz, See <a href="#">Figure 9</a>		6		ms
$t_{dis}$	Disable time, $\overline{SHTDN}$ $\downarrow$ to off-state (CLKOUT high-impedance)	$f_{CLK} = 100$ MHz, See <a href="#">Figure 10</a>		7		ns

(1) All typical values are at  $V_{CC} = 3.3$  V,  $T_A = 25^\circ\text{C}$ .

(2) |Input clock jitter| is the magnitude of the change in the input clock period.

(3) The output clock cycle-to-cycle jitter is the largest recorded change in the output clock period from one cycle to the next cycle observed over 15,000 cycles. Tektronix TDSJIT3 Jitter Analysis software was used to derive the maximum and minimum jitter value.

PARAMETER MEASUREMENT INFORMATION

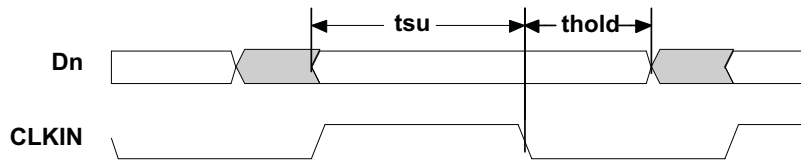

All input timing is defined at  $IOVDD / 2$  on an input signal with a 10% to 90% rise or fall time of less than 3 ns. CLKSEL = 0V.

Figure 3. Set Up and Hold Time Definition

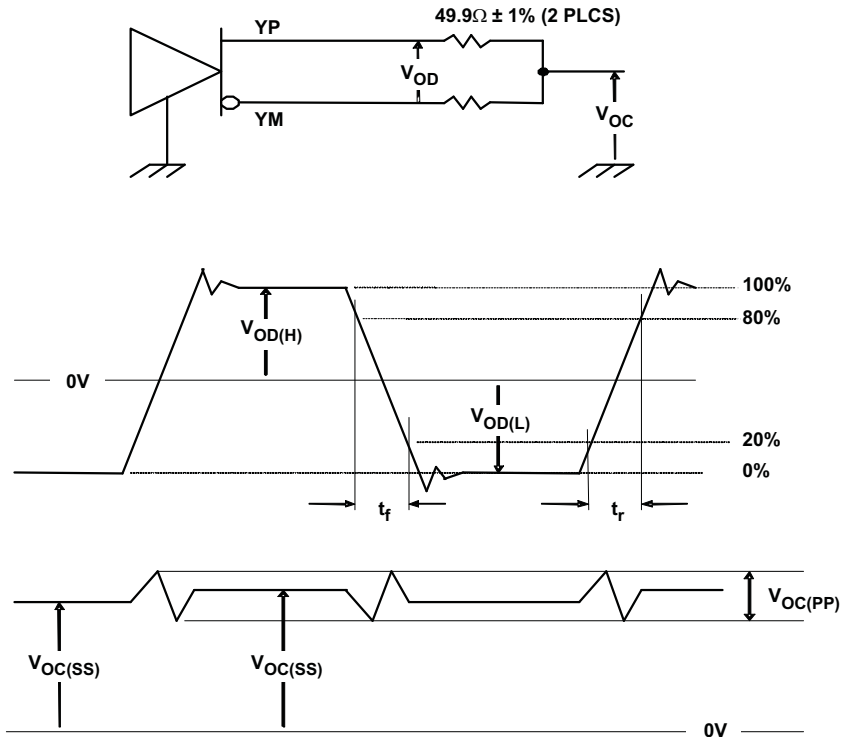
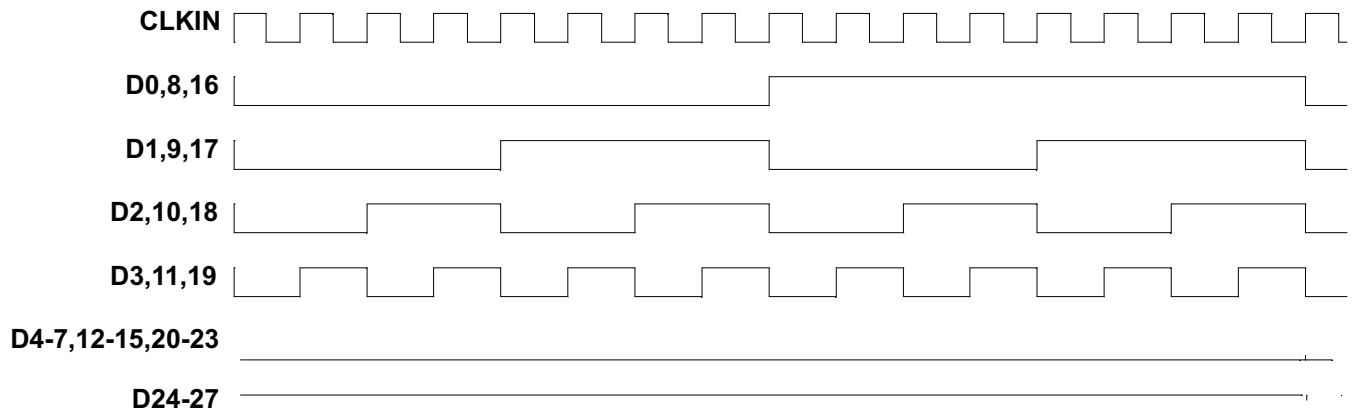

Figure 4. Test Load and Voltage Definitions for LVDS Outputs.



The 16 grayscale test pattern test device power consumption for a typical display pattern.

Figure 5. 16 Grayscale Test Pattern

PARAMETER MEASUREMENT INFORMATION (continued)

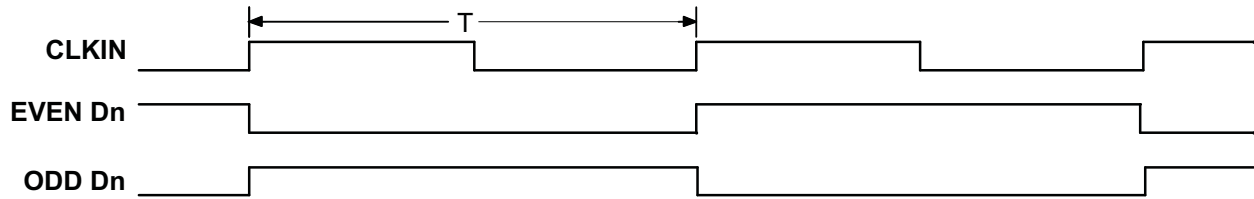

The worst-case test pattern produces nearly the maximum switching frequency for all of the LVDS outputs.

Figure 6. Worst-Case Power Test Pattern

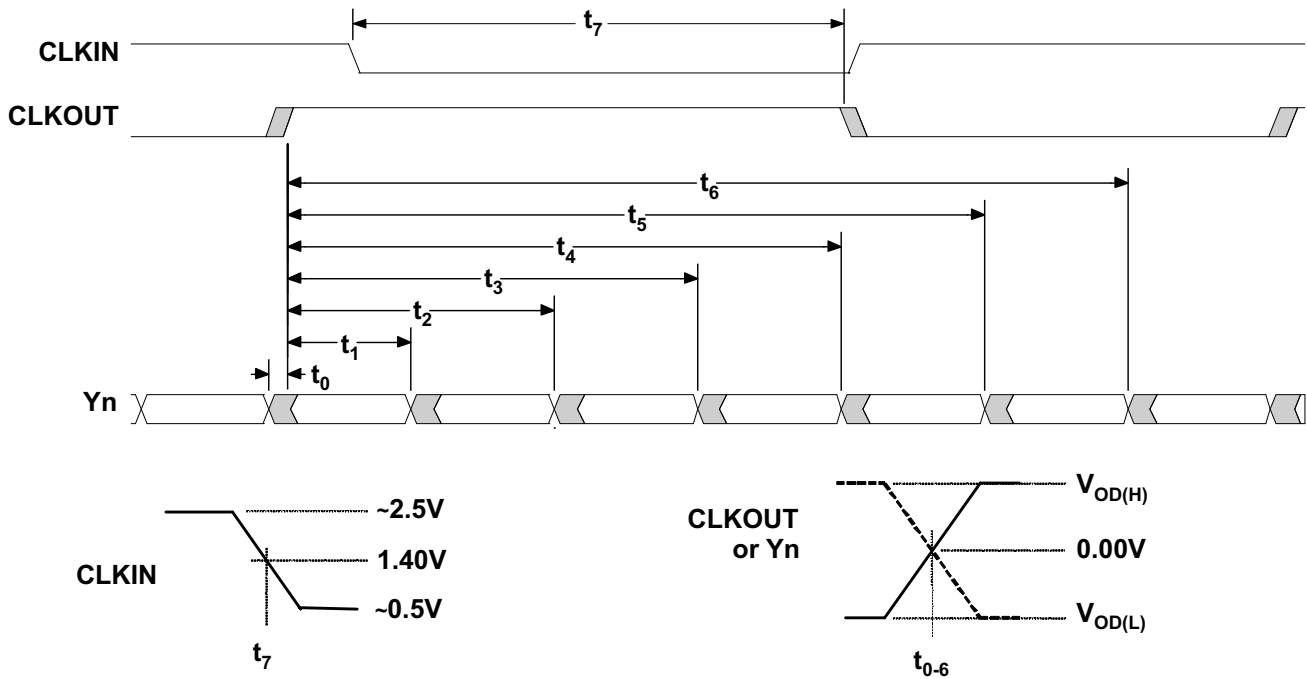

CLKOUT is shown with CLKSEL at high-level.  
CLKIN polarity depends on CLKSEL input level.

Figure 7. SN75LVDS83A Timing Definitions

PARAMETER MEASUREMENT INFORMATION (continued)

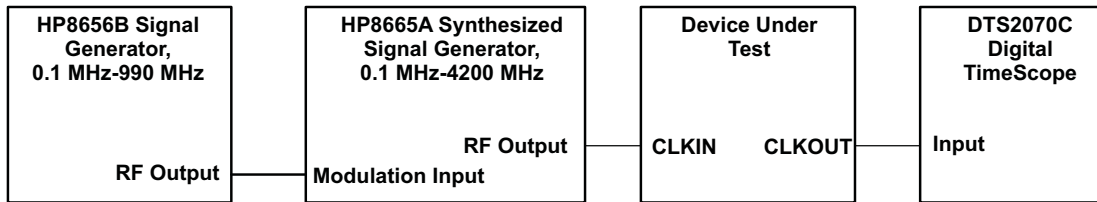
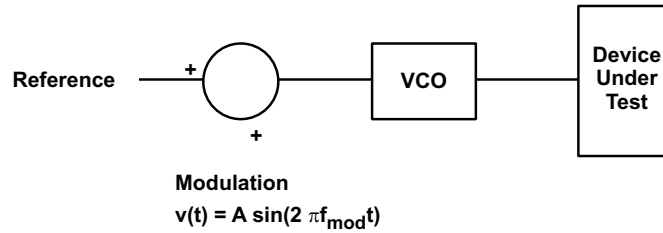

Figure 8. Output Clock Jitter Test Set Up

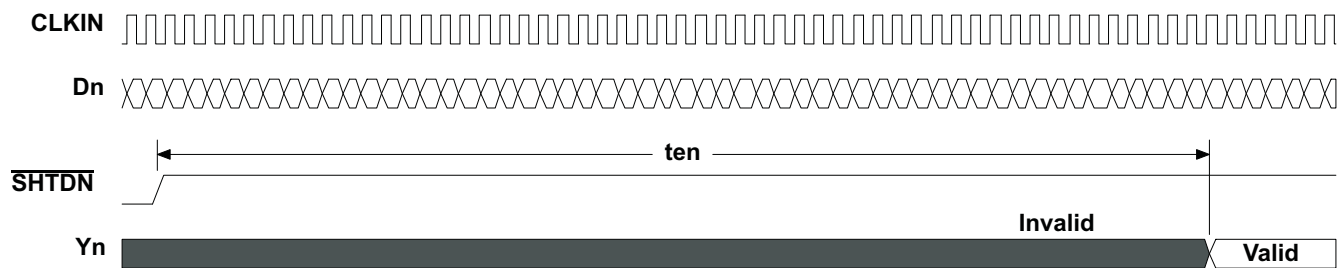

Figure 9. Enable Time Waveforms

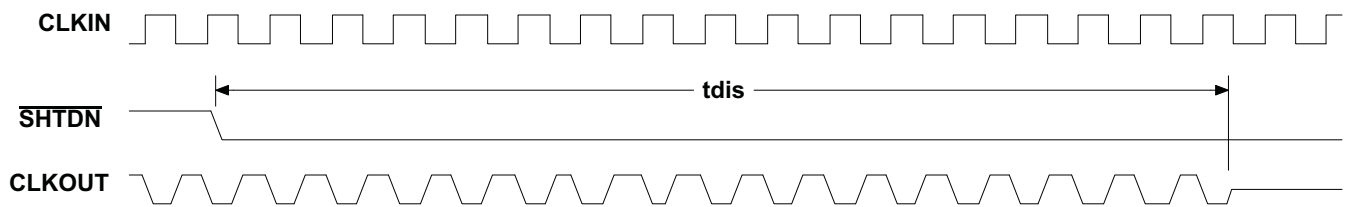

Figure 10. Disable Time Waveforms

TYPICAL CHARACTERISTICS

AVERAGE GRAYSCALE ICC  
vs  
CLOCK FREQUENCY

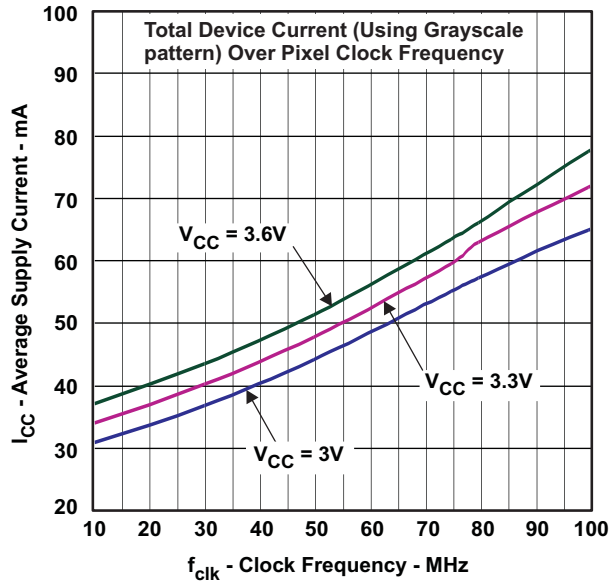

Figure 11.

OUTPUT CLOCK JITTER  
vs  
INPUT CLOCK JITTER

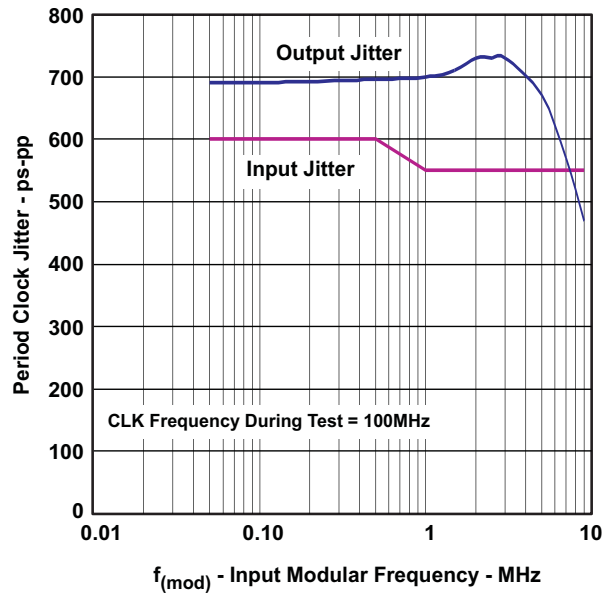
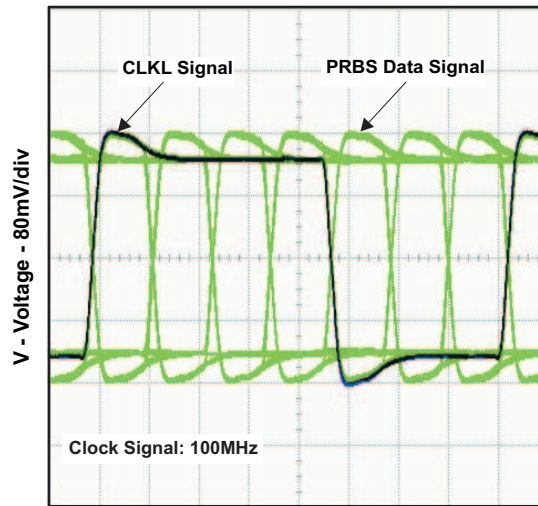

Figure 12.

TYPICAL PRBS OUTPUT SIGNAL  
OVER ONE CLOCK PERIOD



t<sub>k</sub> - Time - 1.2ns/div

Figure 13.

## APPLICATION INFORMATION

This section describes the power up sequence, provides information on device connectivity to various GPU and LCD display panels, and offers a pcb routing example.

### Power Up Sequence

The SN75LVDS83A does not require a specific power up sequence.

The user experience can be impacted by the way a system powers up and powers down an LCD screen. The following sequence is recommended:

Power up sequence (SN75LVDS83A SHTDN input initially low):

1. Ramp up LCD power (maybe 0.5ms to 10ms) but keep backlight turned off.
2. Wait for additional 0-200ms to ensure display noise will not occur.
3. Enable video source output; start sending black video data.
4. Toggle LVDS83A shutdown to  $SHTDN = V_{IH}$
5. Send >1ms of black video data; this allows the LVDS83A to be phase locked, and the display to show black data first.
6. Start sending true image data.
7. Enable backlight.

Power Down sequence (SN75LVDS83A SHTDN input initially high):

1. Disable LCD backlight; wait for the minimum time specified in the LCD data sheet for the backlight to go low.
2. Video source output data switch from active video data to black image data (all visible pixel turn black); drive this for >2 frame times.
3. Set SN75LVDS83A input  $SHTDN = GND$ ; wait for 250ns.
4. Disable the video output of the video source.
5. Remove power from the LCD panel for lowest system power.

### Signal Connectivity

While there is no formal industry standardized specification for the input interface of LVDS LCD panels, the industry has aligned over the years on a certain data format (bit order). [Figure 14](#) through [Figure 17](#) show how each signal should be connected from the graphic source through the SN75LVDS83A input, output and LVDS LCD panel input. Detailed notes are provided with each figure.

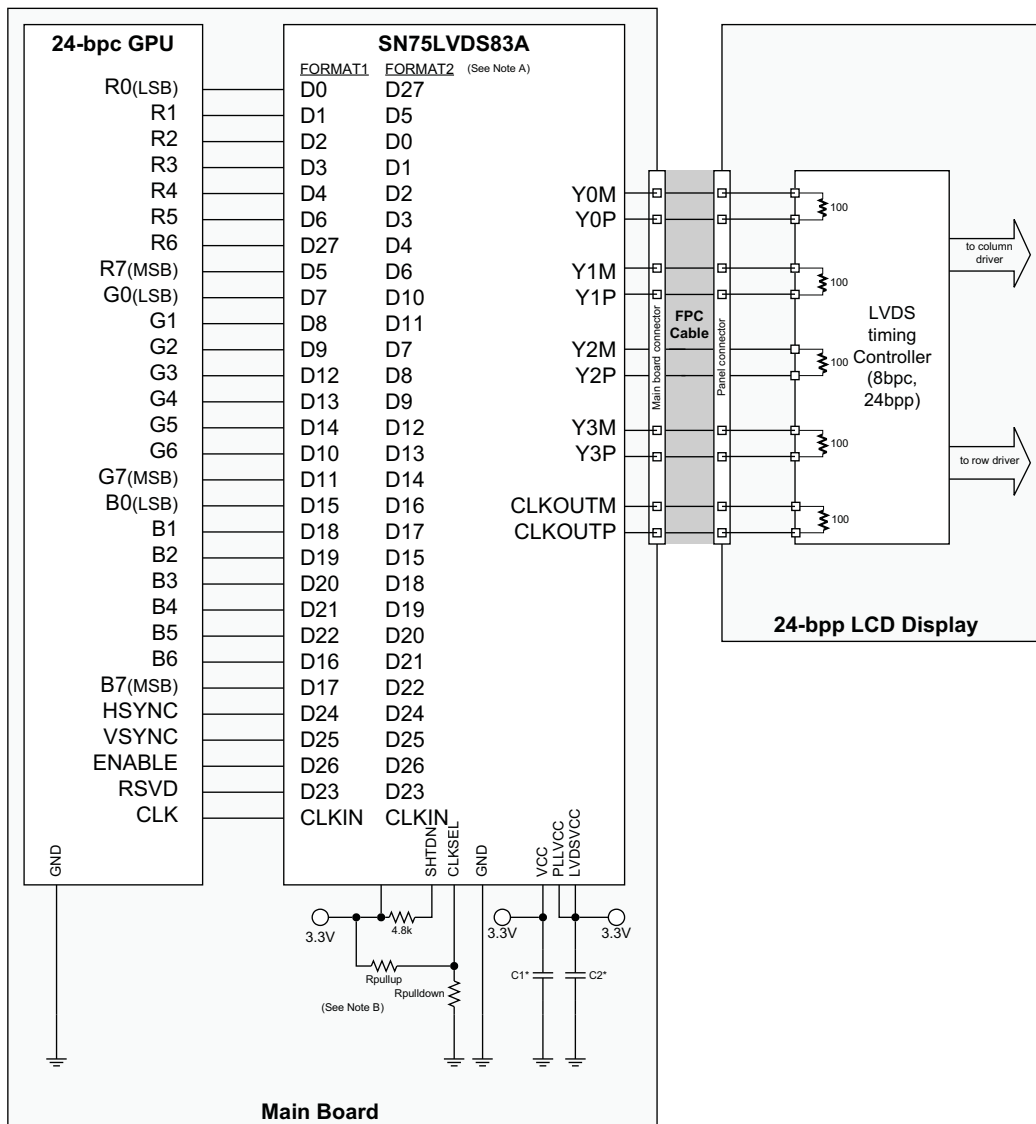

Note A. **FORMAT**: The majority of 24-bit LCD display panels require the two LSBs of each color to be transferred over the 4th serial data output Y3. Other 24-bit LCD display panels require the two LSB of each color to be transmitted over the Y3 output. The system designer needs to verify which format is expected by checking the LCD display data sheet.

- Format 1: use with displays expecting the 2 MSB to be transmitted over the 4th data channel Y3. This is the dominant data format in today's LCD panels
- Format 2: use with displays expecting the 2 LSB to be transmitted over the 4th data channel.

Note B. **Rpullup**: install only to use rising edge triggered clocking.

**Rpulldown**: install only to use falling edge triggered clocking.

- C1: decoupling cap for the VDDIO supply; install at least  $1 \times 0.1\mu\text{F}$  and  $1 \times 0.01\mu\text{F}$
- C2: decoupling cap for the VDD supply; install at least  $1 \times 0.1\mu\text{F}$  and  $1 \times 0.01\mu\text{F}$ .

**Figure 14. 24-Bit Color Host to 24-bit LCD Panel Application**

# SN75LVDS83A

SLLS980D – JUNE 2009 – REVISED JUNE 2011

www.ti.com

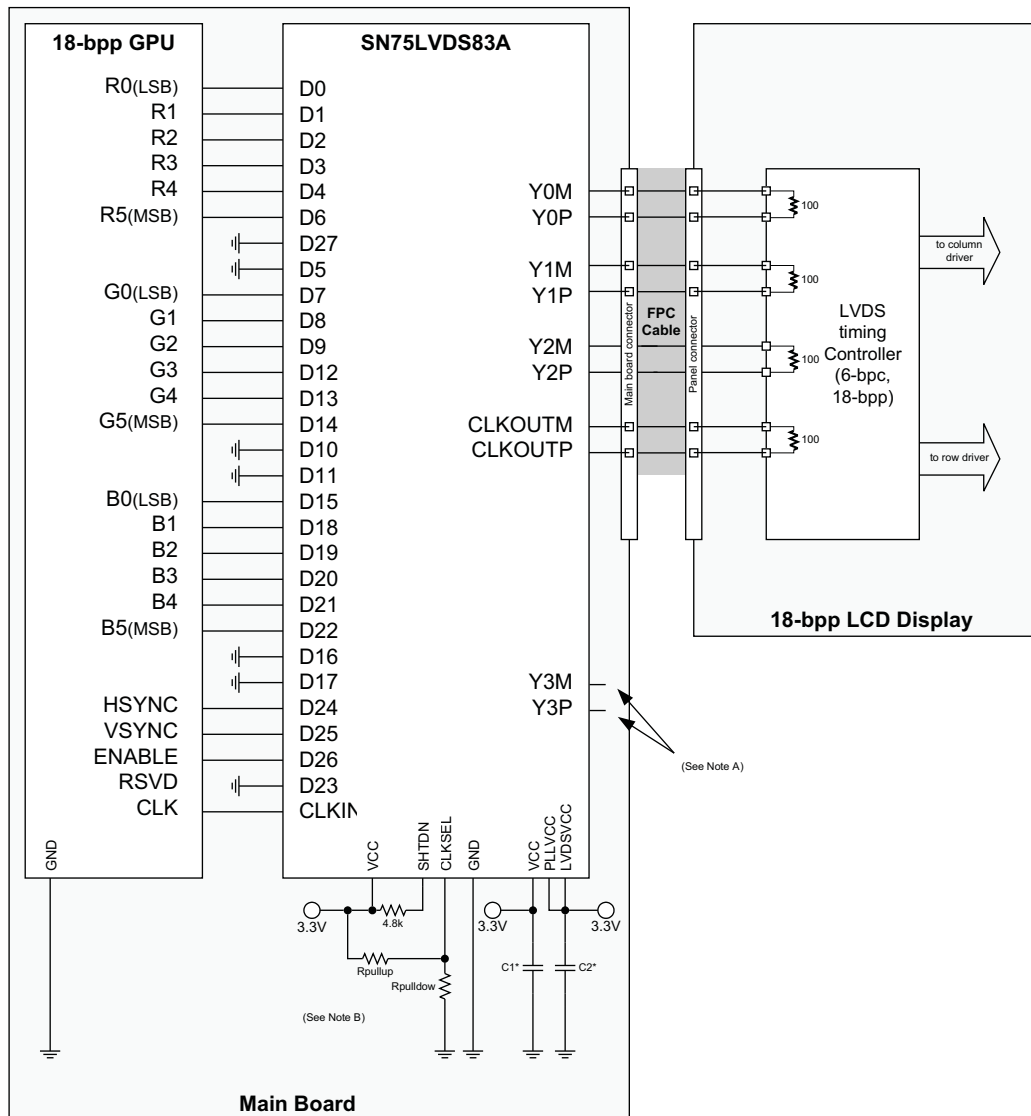

Note A. Leave output Y3 NC.

Note B. **Rpullup**: install only to use rising edge triggered clocking.

**Rpulldown**: install only to use falling edge triggered clocking.

- C1: decoupling cap for the VDDIO supply; install at least  $1 \times 0.1\mu\text{F}$  and  $1 \times 0.01\mu\text{F}$ .
- C2: decoupling cap for the VDD supply; install at least  $1 \times 0.1\mu\text{F}$  and  $1 \times 0.01\mu\text{F}$ .

**Figure 15. 18-Bit Color Host to 18-Bit Color LCD Panel Display Application**

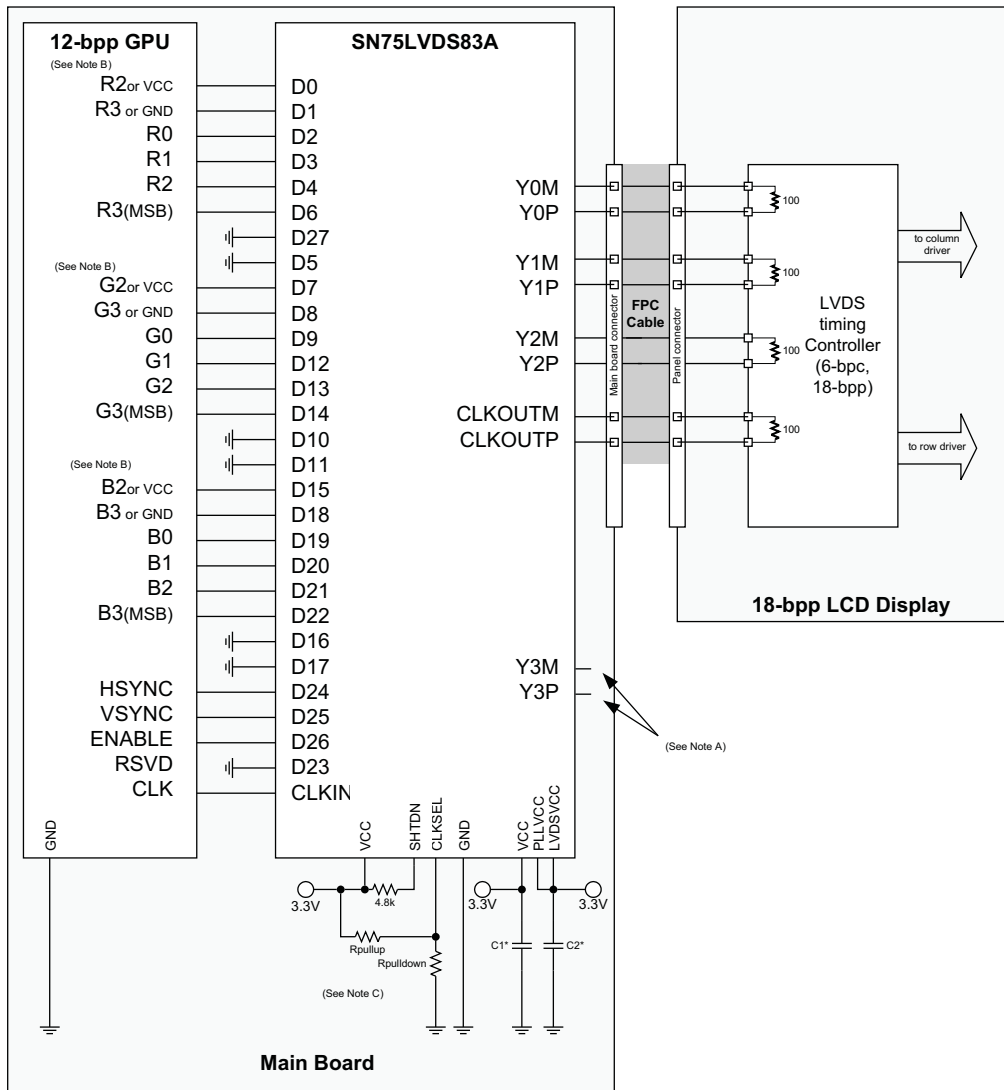

Note A. Leave output Y3 N.C.

Note B. **R3, G3, B3**: this MSB of each color also connects to the 5th bit of each color for increased dynamic range of the entire color space at the expense of none-linear step sizes between each step. For linear steps with less dynamic range, connect D1, D8, and D18 to GND.

**R2, G2, B2**: these outputs also connects to the LSB of each color for increased, dynamic range of the entire color space at the expense of none-linear step sizes between each step. For linear steps with less dynamic range, connect D0, D7, and D15 to VCC.

Note C. **Rpullup**: install only to use rising edge triggered clocking.

**Rpulldown**: install only to use falling edge triggered clocking.

- C1: decoupling cap for the VDDIO supply; install at least 1 × 0.1µF and 1 × 0.01µF.
- C2: decoupling cap for the VDD supply; install at least 1 × 0.1µF and 1 × 0.01µF.

Figure 16. 12-Bit Color Host to 18-Bit Color LCD Panel Display Application

# SN75LVDS83A

SLLS980D – JUNE 2009 – REVISED JUNE 2011

www.ti.com

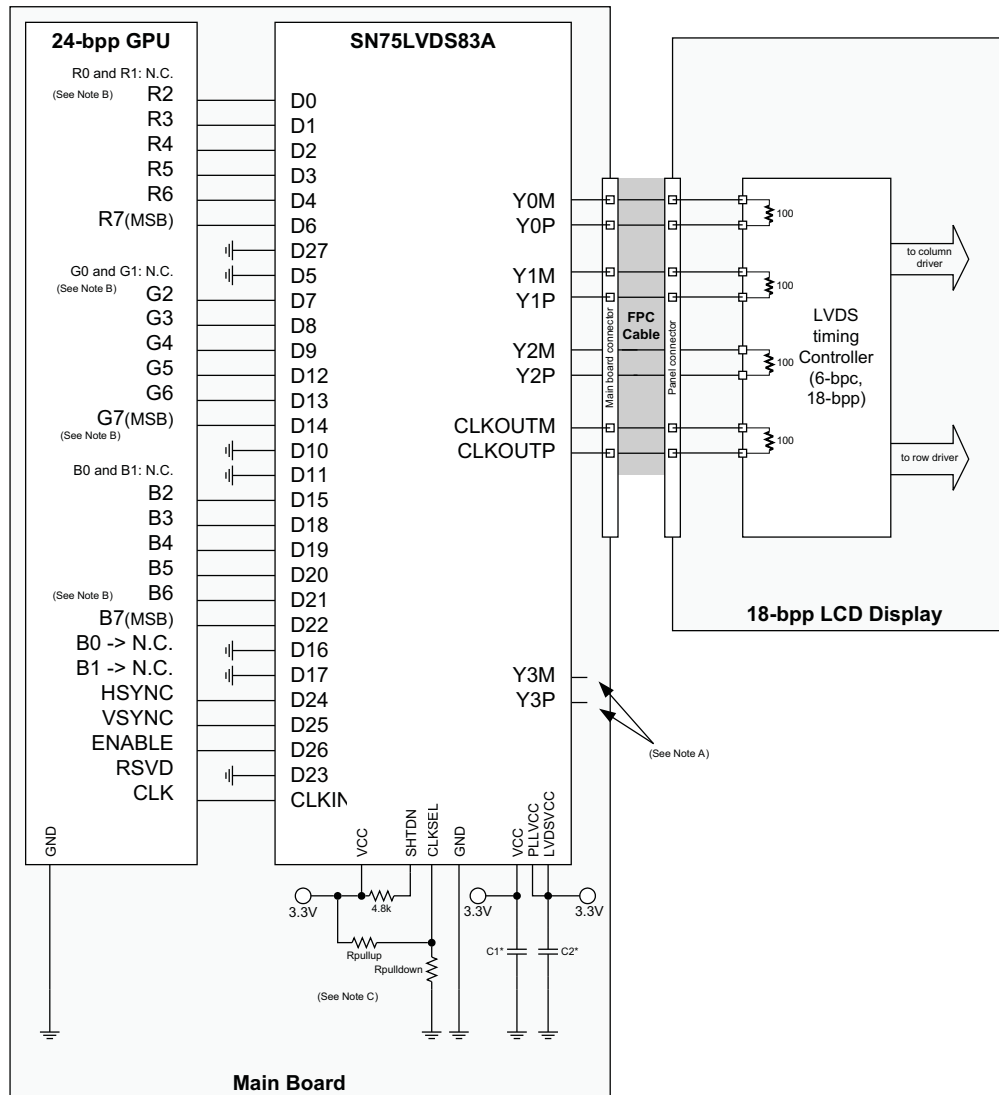

Note A. Leave output Y3 NC.

Note B. **R0, R1, G0, G1, B0, B1**: For improved image quality, the GPU should dither the 24-bit output pixel down to 18-bit per pixel.

Note C. **Rpullup**: install only to use rising edge triggered clocking.

**Rpulldown**: install only to use falling edge triggered clocking.

- C1: decoupling cap for the VDDIO supply; install at least 1 × 0.1µF and 1 × 0.01µF.
- C2: decoupling cap for the VDD supply; install at least 1 × 0.1µF and 1 × 0.01µF.

**Figure 17. 24-Bit Color Host to 18-Bit Color LCD Panel Display Application**

Typical Application Schematic

Figure 18 represents the schematic drawing of the SN75LVDS83A evaluation module.

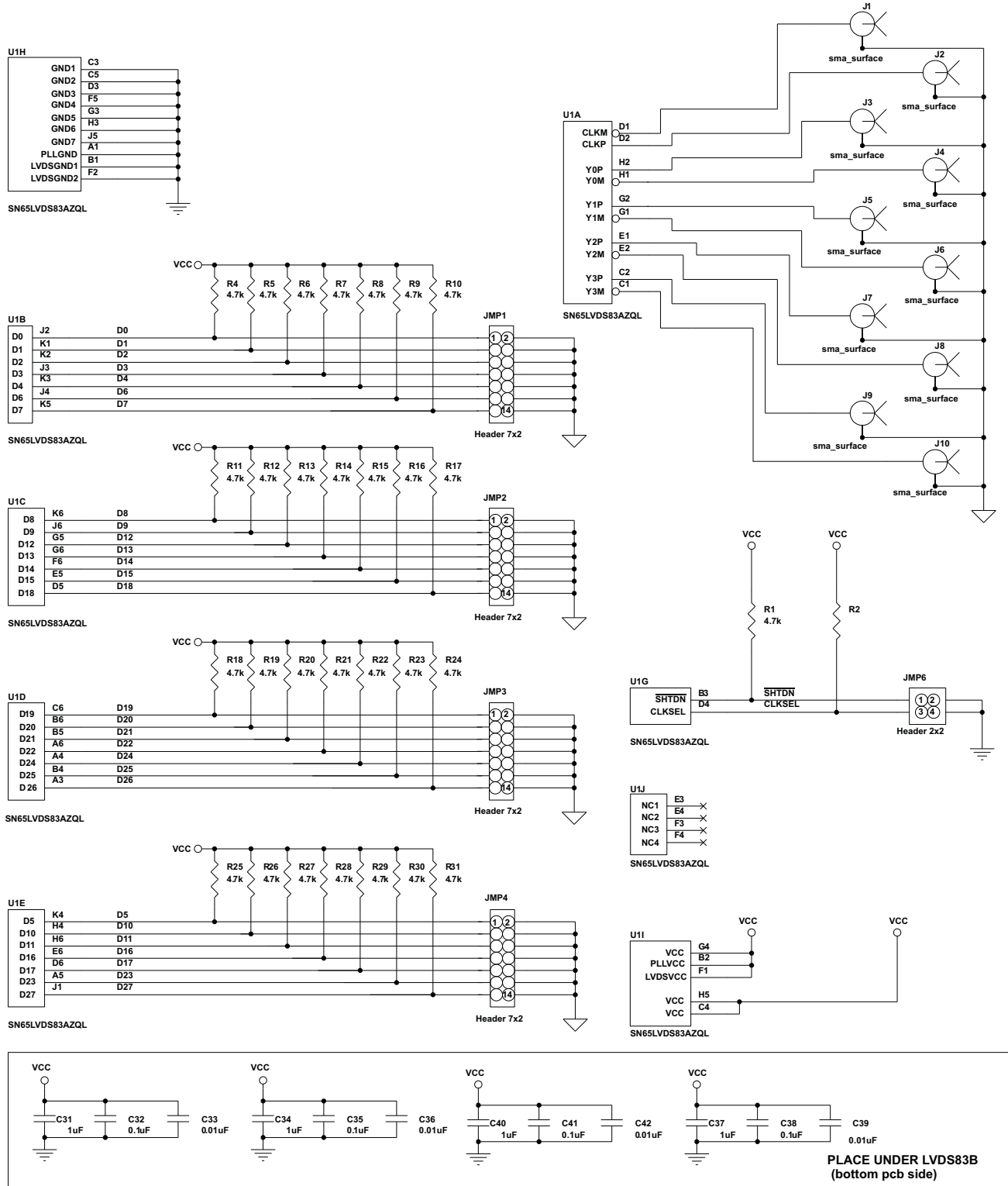

Figure 18. Schematic Example (SN75LVDS83A Evaluation Board)

## REVISION HISTORY

<b>Changes from Original (June 2009) to Revision A</b>	<b>Page</b>
<ul style="list-style-type: none"> <li>• Changed Description text From: Alternative device option: The SN75LVDS83A is an alternative... To: Alternative device option: The SN75LVDS83B is an alternative... .. 2</li> <li>• Changed <a href="#">Figure 13</a> - TYPICAL PRBS OUTPUT SIGNAL OVER ONE CLOCK PERIOD ..... 13</li> </ul>	2 13
<b>Changes from Revision A (June 2009) to Revision B</b>	<b>Page</b>
<ul style="list-style-type: none"> <li>• Changed the data sheet From Product Preview To Production. .... 1</li> </ul>	1
<b>Changes from Revision B (July 2009) to Revision C</b>	<b>Page</b>
<ul style="list-style-type: none"> <li>• Deleted sentence in the Pin Functions table for entry D0 - D27 - "supports 1.8V to 3.3V input voltage selectable by VDD supply." ..... 5</li> </ul>	5
<b>Changes from Revision C (JAugust 2009) to Revision D</b>	<b>Page</b>
<ul style="list-style-type: none"> <li>• Changed <a href="#">Figure 14</a>: From G7(LSB) To G7(MSB) ..... 15</li> </ul>	15

**PACKAGING INFORMATION**

Orderable Device	Status (1)	Package Type	Package Drawing	Pins	Package Qty	Eco Plan (2)	Lead/Ball Finish	MSL Peak Temp (3)	Op Temp (°C)	Top-Side Markings (4)	Samples
SN75LVDS83ADGG	ACTIVE	TSSOP	DGG	56	35	Green (RoHS & no Sb/Br)	CU NIPDAU	Level-2-260C-1 YEAR	-10 to 70	LVDS83A	<a href="#">Samples</a>
SN75LVDS83ADGGR	ACTIVE	TSSOP	DGG	56	2000	Green (RoHS & no Sb/Br)	CU NIPDAU	Level-2-260C-1 YEAR	-10 to 70	LVDS83A	<a href="#">Samples</a>

(1) The marketing status values are defined as follows:

**ACTIVE:** Product device recommended for new designs.

**LIFEBUY:** TI has announced that the device will be discontinued, and a lifetime-buy period is in effect.

**NRND:** Not recommended for new designs. Device is in production to support existing customers, but TI does not recommend using this part in a new design.

**PREVIEW:** Device has been announced but is not in production. Samples may or may not be available.

**OBSOLETE:** TI has discontinued the production of the device.

(2) Eco Plan - The planned eco-friendly classification: Pb-Free (RoHS), Pb-Free (RoHS Exempt), or Green (RoHS & no Sb/Br) - please check <http://www.ti.com/productcontent> for the latest availability information and additional product content details.

**TBD:** The Pb-Free/Green conversion plan has not been defined.

**Pb-Free (RoHS):** TI's terms "Lead-Free" or "Pb-Free" mean semiconductor products that are compatible with the current RoHS requirements for all 6 substances, including the requirement that lead not exceed 0.1% by weight in homogeneous materials. Where designed to be soldered at high temperatures, TI Pb-Free products are suitable for use in specified lead-free processes.

**Pb-Free (RoHS Exempt):** This component has a RoHS exemption for either 1) lead-based flip-chip solder bumps used between the die and package, or 2) lead-based die adhesive used between the die and leadframe. The component is otherwise considered Pb-Free (RoHS compatible) as defined above.

**Green (RoHS & no Sb/Br):** TI defines "Green" to mean Pb-Free (RoHS compatible), and free of Bromine (Br) and Antimony (Sb) based flame retardants (Br or Sb do not exceed 0.1% by weight in homogeneous material)

(3) MSL, Peak Temp. -- The Moisture Sensitivity Level rating according to the JEDEC industry standard classifications, and peak solder temperature.

(4) Multiple Top-Side Markings will be inside parentheses. Only one Top-Side Marking contained in parentheses and separated by a "~" will appear on a device. If a line is indented then it is a continuation of the previous line and the two combined represent the entire Top-Side Marking for that device.

**Important Information and Disclaimer:** The information provided on this page represents TI's knowledge and belief as of the date that it is provided. TI bases its knowledge and belief on information provided by third parties, and makes no representation or warranty as to the accuracy of such information. Efforts are underway to better integrate information from third parties. TI has taken and continues to take reasonable steps to provide representative and accurate information but may not have conducted destructive testing or chemical analysis on incoming materials and chemicals. TI and TI suppliers consider certain information to be proprietary, and thus CAS numbers and other limited information may not be available for release.

In no event shall TI's liability arising out of such information exceed the total purchase price of the TI part(s) at issue in this document sold by TI to Customer on an annual basis.

## TAPE AND REEL INFORMATION

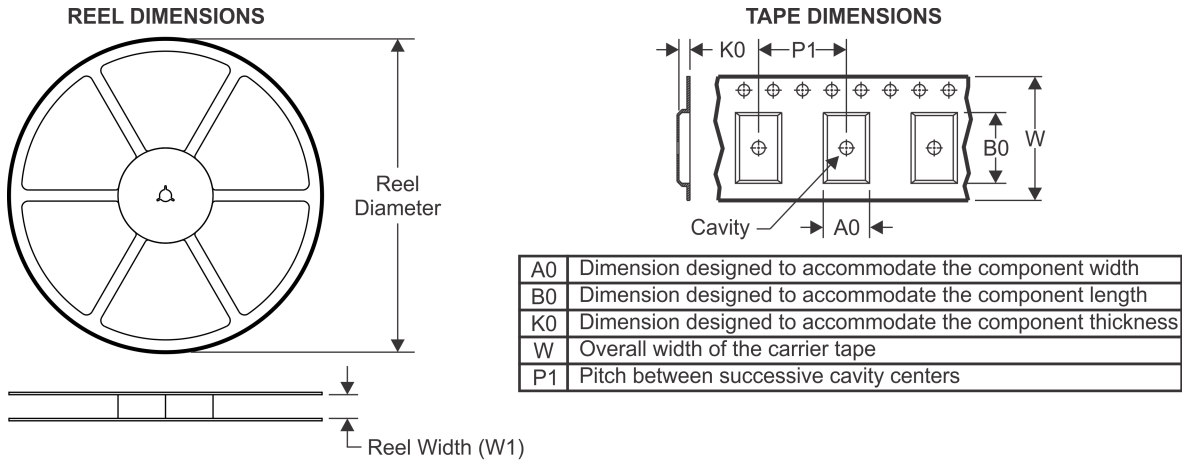

### QUADRANT ASSIGNMENTS FOR PIN 1 ORIENTATION IN TAPE



\*All dimensions are nominal

Device	Package Type	Package Drawing	Pins	SPQ	Reel Diameter (mm)	Reel Width W1 (mm)	A0 (mm)	B0 (mm)	K0 (mm)	P1 (mm)	W (mm)	Pin1 Quadrant
SN75LVDS83ADGGR	TSSOP	DGG	56	2000	330.0	24.4	8.6	15.6	1.8	12.0	24.0	Q1

TAPE AND REEL BOX DIMENSIONS



\*All dimensions are nominal

Device	Package Type	Package Drawing	Pins	SPQ	Length (mm)	Width (mm)	Height (mm)
SN75LVDS83ADGGR	TSSOP	DGG	56	2000	367.0	367.0	45.0

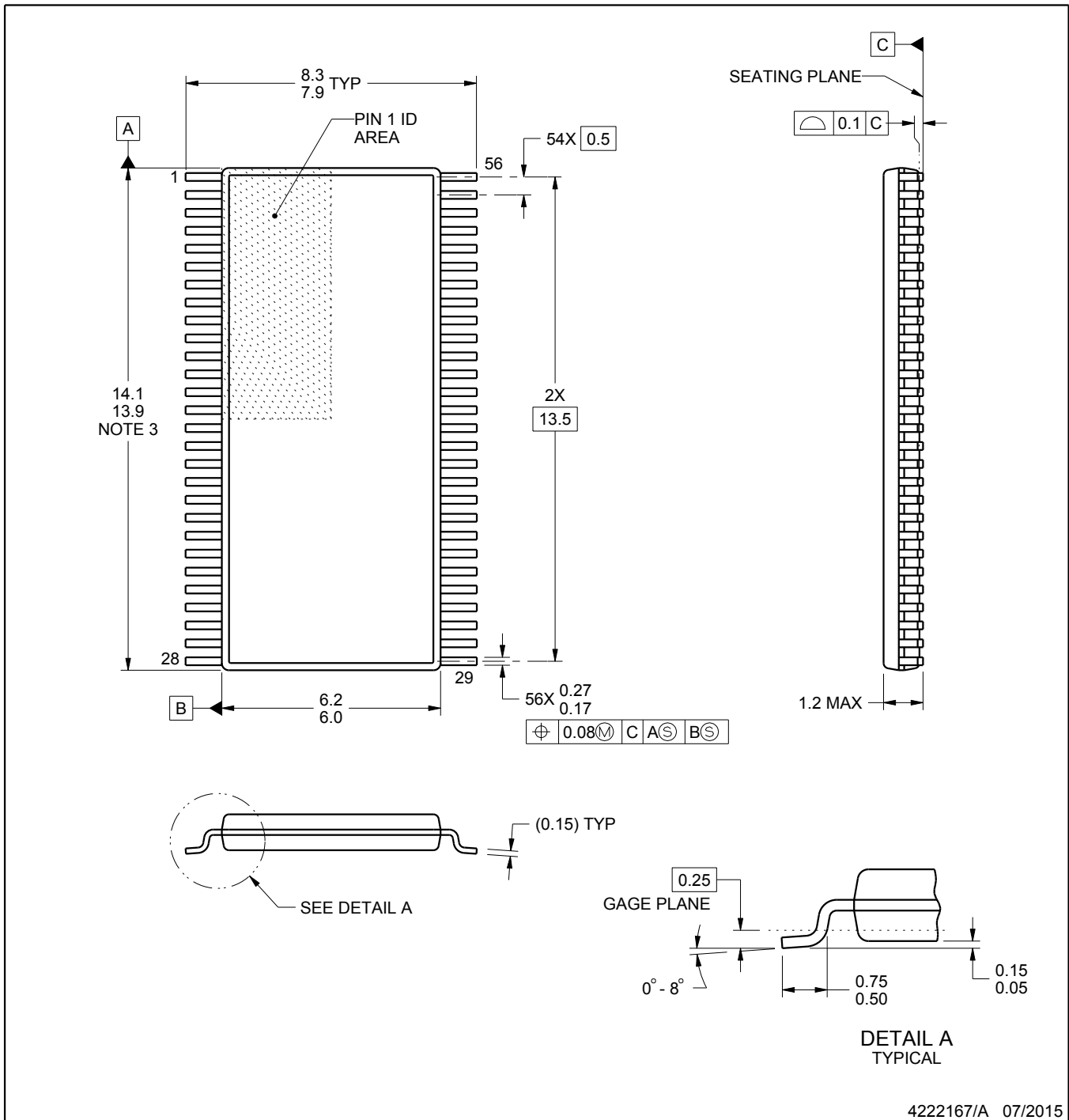

4222167/A 07/2015

NOTES:

1. All linear dimensions are in millimeters. Any dimensions in parenthesis are for reference only. Dimensioning and tolerancing per ASME Y14.5M.
2. This drawing is subject to change without notice.
3. This dimension does not include mold flash, protrusions, or gate burrs. Mold flash, protrusions, or gate burrs shall not exceed 0.15 mm per side.
4. Reference JEDEC registration MO-153.

# EXAMPLE BOARD LAYOUT

DGG0056A

TSSOP - 1.2 mm max height

SMALL OUTLINE PACKAGE

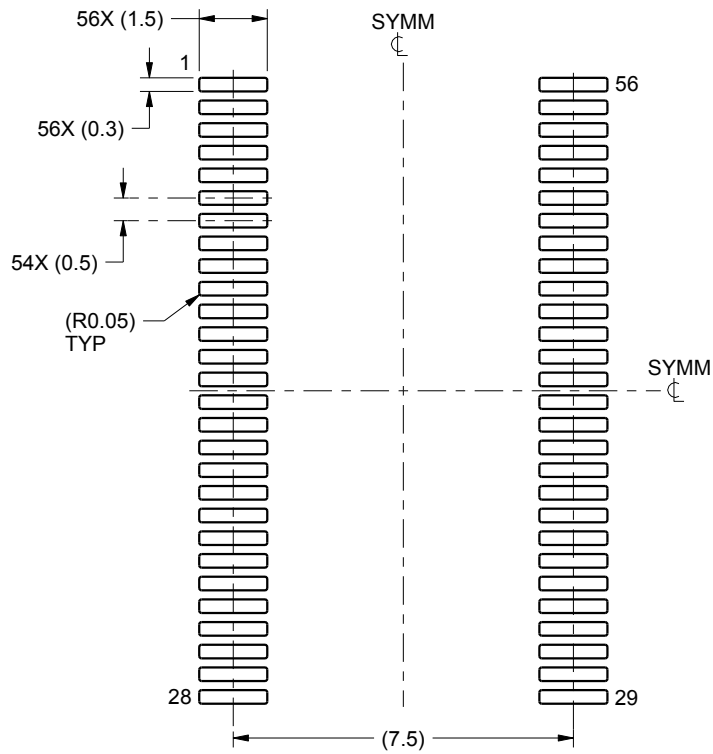

LAND PATTERN EXAMPLE  
SCALE:6X

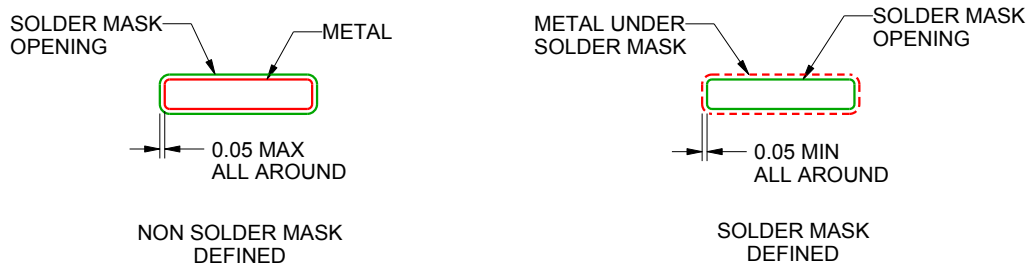

SOLDER MASK DETAILS

4222167/A 07/2015

NOTES: (continued)

- 5. Publication IPC-7351 may have alternate designs.
- 6. Solder mask tolerances between and around signal pads can vary based on board fabrication site.

# EXAMPLE STENCIL DESIGN

DGG0056A

TSSOP - 1.2 mm max height

SMALL OUTLINE PACKAGE

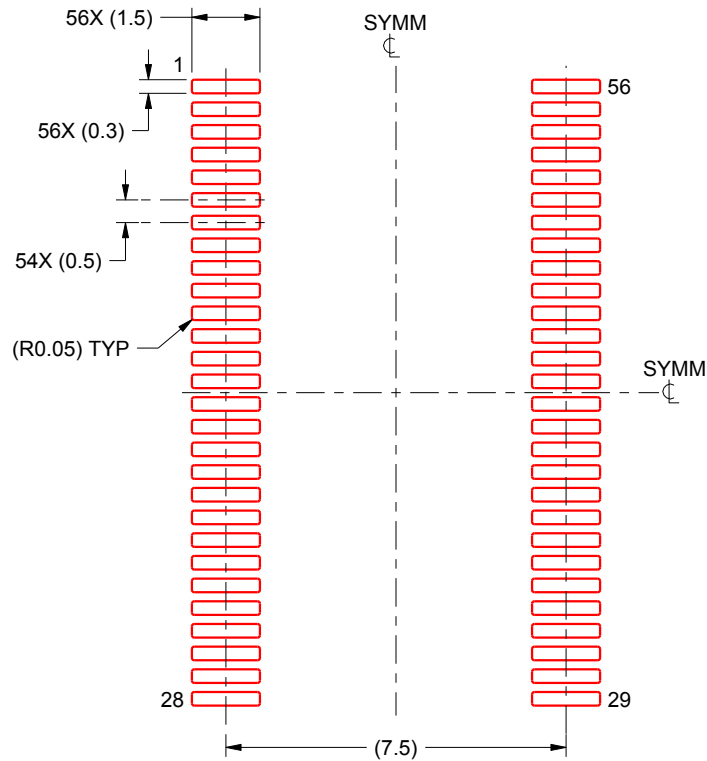

SOLDER PASTE EXAMPLE  
BASED ON 0.125 mm THICK STENCIL  
SCALE:6X

4222167/A 07/2015

NOTES: (continued)

7. Laser cutting apertures with trapezoidal walls and rounded corners may offer better paste release. IPC-7525 may have alternate design recommendations.
8. Board assembly site may have different recommendations for stencil design.

## IMPORTANT NOTICE

Texas Instruments Incorporated and its subsidiaries (TI) reserve the right to make corrections, enhancements, improvements and other changes to its semiconductor products and services per JESD46, latest issue, and to discontinue any product or service per JESD48, latest issue. Buyers should obtain the latest relevant information before placing orders and should verify that such information is current and complete. All semiconductor products (also referred to herein as "components") are sold subject to TI's terms and conditions of sale supplied at the time of order acknowledgment.

TI warrants performance of its components to the specifications applicable at the time of sale, in accordance with the warranty in TI's terms and conditions of sale of semiconductor products. Testing and other quality control techniques are used to the extent TI deems necessary to support this warranty. Except where mandated by applicable law, testing of all parameters of each component is not necessarily performed.

TI assumes no liability for applications assistance or the design of Buyers' products. Buyers are responsible for their products and applications using TI components. To minimize the risks associated with Buyers' products and applications, Buyers should provide adequate design and operating safeguards.

TI does not warrant or represent that any license, either express or implied, is granted under any patent right, copyright, mask work right, or other intellectual property right relating to any combination, machine, or process in which TI components or services are used. Information published by TI regarding third-party products or services does not constitute a license to use such products or services or a warranty or endorsement thereof. Use of such information may require a license from a third party under the patents or other intellectual property of the third party, or a license from TI under the patents or other intellectual property of TI.

Reproduction of significant portions of TI information in TI data books or data sheets is permissible only if reproduction is without alteration and is accompanied by all associated warranties, conditions, limitations, and notices. TI is not responsible or liable for such altered documentation. Information of third parties may be subject to additional restrictions.

Resale of TI components or services with statements different from or beyond the parameters stated by TI for that component or service voids all express and any implied warranties for the associated TI component or service and is an unfair and deceptive business practice. TI is not responsible or liable for any such statements.

Buyer acknowledges and agrees that it is solely responsible for compliance with all legal, regulatory and safety-related requirements concerning its products, and any use of TI components in its applications, notwithstanding any applications-related information or support that may be provided by TI. Buyer represents and agrees that it has all the necessary expertise to create and implement safeguards which anticipate dangerous consequences of failures, monitor failures and their consequences, lessen the likelihood of failures that might cause harm and take appropriate remedial actions. Buyer will fully indemnify TI and its representatives against any damages arising out of the use of any TI components in safety-critical applications.

In some cases, TI components may be promoted specifically to facilitate safety-related applications. With such components, TI's goal is to help enable customers to design and create their own end-product solutions that meet applicable functional safety standards and requirements. Nonetheless, such components are subject to these terms.

No TI components are authorized for use in FDA Class III (or similar life-critical medical equipment) unless authorized officers of the parties have executed a special agreement specifically governing such use.

Only those TI components which TI has specifically designated as military grade or "enhanced plastic" are designed and intended for use in military/aerospace applications or environments. Buyer acknowledges and agrees that any military or aerospace use of TI components which have **not** been so designated is solely at the Buyer's risk, and that Buyer is solely responsible for compliance with all legal and regulatory requirements in connection with such use.

TI has specifically designated certain components as meeting ISO/TS16949 requirements, mainly for automotive use. In any case of use of non-designated products, TI will not be responsible for any failure to meet ISO/TS16949.

### Products

Audio	<a href="http://www.ti.com/audio">www.ti.com/audio</a>
Amplifiers	<a href="http://amplifier.ti.com">amplifier.ti.com</a>
Data Converters	<a href="http://dataconverter.ti.com">dataconverter.ti.com</a>
DLP® Products	<a href="http://www.dlp.com">www.dlp.com</a>
DSP	<a href="http://dsp.ti.com">dsp.ti.com</a>
Clocks and Timers	<a href="http://www.ti.com/clocks">www.ti.com/clocks</a>
Interface	<a href="http://interface.ti.com">interface.ti.com</a>
Logic	<a href="http://logic.ti.com">logic.ti.com</a>
Power Mgmt	<a href="http://power.ti.com">power.ti.com</a>
Microcontrollers	<a href="http://microcontroller.ti.com">microcontroller.ti.com</a>
RFID	<a href="http://www.ti-rfid.com">www.ti-rfid.com</a>
OMAP Applications Processors	<a href="http://www.ti.com/omap">www.ti.com/omap</a>
Wireless Connectivity	<a href="http://www.ti.com/wirelessconnectivity">www.ti.com/wirelessconnectivity</a>

### Applications

Automotive and Transportation	<a href="http://www.ti.com/automotive">www.ti.com/automotive</a>
Communications and Telecom	<a href="http://www.ti.com/communications">www.ti.com/communications</a>
Computers and Peripherals	<a href="http://www.ti.com/computers">www.ti.com/computers</a>
Consumer Electronics	<a href="http://www.ti.com/consumer-apps">www.ti.com/consumer-apps</a>
Energy and Lighting	<a href="http://www.ti.com/energy">www.ti.com/energy</a>
Industrial	<a href="http://www.ti.com/industrial">www.ti.com/industrial</a>
Medical	<a href="http://www.ti.com/medical">www.ti.com/medical</a>
Security	<a href="http://www.ti.com/security">www.ti.com/security</a>
Space, Avionics and Defense	<a href="http://www.ti.com/space-avionics-defense">www.ti.com/space-avionics-defense</a>
Video and Imaging	<a href="http://www.ti.com/video">www.ti.com/video</a>

### TI E2E Community

[e2e.ti.com](http://e2e.ti.com)