

# LM3490 100 mA, SOT-23, Quasi Low-Dropout Linear Voltage Regulator with Logic-Controlled ON/OFF

Check for Samples: [LM3490](#)

## FEATURES

- 3.3, 5, 12, and 15V Versions Available
- Logic-Controlled ON/OFF
- Packaged in the Tiny 5-Lead SOT-23 Package

## APPLICATIONS

- Tiny Alternative to LM78LXX Series and Similar Devices
- Tiny  $5V \pm 5\%$  to 3.3V, 100 mA Converter
- Post Regulator for Switching DC/DC Converter
- Bias Supply for Analog Circuits

## KEY SPECIFICATIONS

- 30V Maximum Input for Operation
- 1.2V Specified Maximum Dropout over Full Load and Temperature Ranges
- 100 mA Specified Load Current
- $\pm 5\%$  Specified Output Voltage Tolerance over Full Load and Temperature Ranges
- $-40$  to  $+125^\circ\text{C}$  Junction Temperature Range for Operation

## Typical Application Circuit

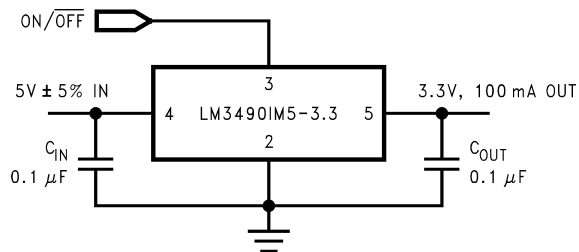

## DESCRIPTION

The LM3490 is an integrated linear voltage regulator. It features operation from an input as high as 30V and a specified maximum dropout of 1.2V at the full 100 mA load. Standard packaging for the LM3490 is the 5-lead SOT-23 package. A logic-controlled ON/OFF feature makes the LM3490 ideal for powering subsystems ON and OFF as needed.

The 5, 12, and 15V members of the LM3490 series are intended as tiny alternatives to industry standard LM78LXX series and similar devices. The 1.2V quasi low dropout of LM3490 series devices makes them a nice fit in many applications where the 2 to 2.5V dropout of LM78LXX series devices precludes their (LM78LXX series devices) use.

The LM3490 series features a 3.3V member. The SOT packaging and quasi low dropout features of the LM3490 series converge in this device to provide a very nice, very tiny 3.3V, 100 mA bias supply that regulates directly off the system  $5V \pm 5\%$  power supply.

## Connection Diagram

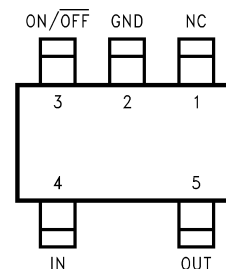

**Figure 1. Top View  
SOT-23 Package  
5-Lead, Molded-Plastic Small-Outline Transistor  
(SOT) Package  
Package Code DBV0005A**



Please be aware that an important notice concerning availability, standard warranty, and use in critical applications of Texas Instruments semiconductor products and disclaimers thereto appears at the end of this data sheet.

All trademarks are the property of their respective owners.



These devices have limited built-in ESD protection. The leads should be shorted together or the device placed in conductive foam during storage or handling to prevent electrostatic damage to the MOS gates.

## ABSOLUTE MAXIMUM RATINGS<sup>(1)(2)</sup>

Input Voltage (IN to GND)		35V
Voltage ON/OFF to GND		5.5V
Power Dissipation <sup>(3)</sup>		400 mW
Junction Temp. (T <sub>J</sub> ) <sup>(3)</sup>		+150°C
Ambient Storage Temp.		-65 to +150°C
Soldering Time, Temp. <sup>(4)</sup>	Wave	4sec., 260°C
	Infrared	10sec., 240°C
	Vapor Phase	75sec., 219°C
ESD <sup>(5)</sup>	ON/OFF	1.0kV
	All Other Pins	2.0kV

- (1) Absolute Maximum Ratings are limits beyond which damage to the device may occur. Operating Ratings are conditions under which operation of the device is specified. Operating Ratings do not imply ensured performance limits. For ensured performance limits and associated test conditions, see the Electrical Characteristics tables.
- (2) If Military/Aerospace specified devices are required, please contact the Texas Instruments Sales Office/Distributors for availability and specifications.
- (3) The Absolute Maximum power dissipation depends on the ambient temperature and can be calculated using  $P = (T_J - T_A)/\theta_{JA}$  where  $T_J$  is the junction temperature,  $T_A$  is the ambient temperature, and  $\theta_{JA}$  is the junction-to-ambient thermal resistance. The 400 mW rating results from substituting the Absolute Maximum junction temperature, 150°C, for  $T_J$ , 50°C for  $T_A$ , and 250°C/W for  $\theta_{JA}$ . More power can be safely dissipated at lower ambient temperatures. Less power can be safely dissipated at higher ambient temperatures. The Absolute Maximum power dissipation can be increased by 4 mW for each °C below 50°C ambient. It must be derated by 4 mW for each °C above 50°C ambient. A  $\theta_{JA}$  of 250°C/W represents the worst-case condition of no heat sinking of the 5-lead plastic SOT-23 package. Heat sinking enables the safe dissipation of more power. The LM3490 actively limits its junction temperature to about 150°C.
- (4) Times shown are dwell times. Temperatures shown are dwell temperatures. For detailed information on soldering plastic small-outline packages, see <http://www.ti.com>.
- (5) For testing purposes, ESD was applied using the human-body model, a 100 pF capacitor discharged through a 1.5 kΩ resistor.

## OPERATING RATINGS<sup>(1)</sup>

Maximum Input Voltage (IN to GND)		30V
Voltage ON/OFF to GND		0 to 5V
Junction Temperature (T <sub>J</sub> )		-40 to +125°C
Maximum Power Dissipation <sup>(2)</sup>		300 mW

- (1) Absolute Maximum Ratings are limits beyond which damage to the device may occur. Operating Ratings are conditions under which operation of the device is specified. Operating Ratings do not imply ensured performance limits. For ensured performance limits and associated test conditions, see the Electrical Characteristics tables.
- (2) As with the Absolute Maximum power dissipation, the maximum power dissipation for operation depends on the ambient temperature. The 300 mW rating appearing under Operating Ratings results from substituting the maximum junction temperature for operation, 125°C, for  $T_J$ , 50°C for  $T_A$ , and 250°C/W for  $\theta_{JA}$  in  $P = (T_J - T_A)/\theta_{JA}$ . More power can be dissipated at lower ambient temperatures. Less power can be dissipated at higher ambient temperatures. The maximum power dissipation for operation appearing under Operating Ratings can be increased by 4 mW for each °C below 50°C ambient. It must be derated by 4 mW for each °C above 50°C ambient. A  $\theta_{JA}$  of 250°C/W represents the worst-case condition of no heat sinking of the 5-lead plastic SOT-23 package. Heat sinking enables the dissipation of more power during operation.

**ELECTRICAL CHARACTERISTICS LM3490-3.3, LM3490-5.0**

$V_{IN} = V_{NOM} + 1.5V$  unless otherwise noted. Typical and limits appearing in normal type apply for  $T_A = T_J = 25^\circ C$ . Limits appearing in boldface type apply over the entire junction temperature range for operation,  $-40$  to  $+125^\circ C$ <sup>(1)(2)(3)</sup>

Nominal Output Voltage ( $V_{NOM}$ )			3.3V		5.0V		Units
Symbol	Parameter	Conditions	Typical	Limit	Typical	Limit	
$V_{OUT}$	Output Voltage	$1\text{ mA} \leq I_{OUT} \leq 100\text{ mA}$	3.30	3.17 <b>3.14</b> 3.43 <b>3.46</b>	5.00	4.80 <b>4.75</b> 5.20 <b>5.25</b>	V V(min) V(min) V(max) V(max)
$\Delta V_{OUT}$	Line Regulation	$V_{NOM} + 1.5V \leq V_{IN} \leq 30V$ , $I_{OUT} = 1\text{ mA}$	7	<b>25</b>	9	<b>25</b>	mV mV(max)
$\Delta V_{OUT}$	Load Regulation	$10\text{ mA} \leq I_{OUT} \leq 100\text{ mA}$	15	<b>40</b>	15	<b>40</b>	mV mV(max)
$I_{GND}$	Ground Pin Current	$V_{NOM} + 1.5V \leq V_{IN} \leq 30V$ , No Load					
		$V_{ON/OFF} = 5V$	2	<b>4</b>	2	<b>4</b>	mA mA(max)
		$V_{ON/OFF} = 0V$	0.1	<b>5</b>	0.1	<b>5</b>	$\mu A$ $\mu A$ (max)
$V_{IN} - V_{OUT}$	Dropout Voltage	$I_{OUT} = 10\text{ mA}$	0.7	0.9 <b>1.0</b>	0.7	0.9 <b>1.0</b>	V V(max) V(max)
		$I_{OUT} = 100\text{ mA}$	0.9	1.1 <b>1.2</b>	0.9	1.1 <b>1.2</b>	V V(max) V(max)
$e_n$	Output Noise Voltage	$V_{IN} = 10V$ , Bandwidth: 10 Hz to 100 kHz	100		150		$\mu V_{rms}$
$V_{IL}$	Maximum Low Level Input Voltage at ON/OFF			<b>0.2</b>		<b>0.2</b>	V(max)
$V_{IH}$	Minimum High Level Input Voltage at ON/OFF			<b>2.0</b>		<b>2.0</b>	V(min)
$I_{IL}$		$V_{ON/OFF} = 0V$		<b>-1</b>		<b>-1</b>	$\mu A$ (max)
$I_{IH}$		$V_{ON/OFF} = 5V$	1	<b>20</b>	1	<b>20</b>	$\mu A$ $\mu A$ (max)

- (1) A typical is the center of characterization data taken with  $T_A = T_J = 25^\circ C$ . Typical values are not ensured.
- (2) All limits are specified. All electrical characteristics having room-temperature limits are tested during production with  $T_A = T_J = 25^\circ C$ . All hot and cold limits are specified by correlating the electrical characteristics to process and temperature variations and applying statistical process control.
- (3) All voltages except dropout are with respect to the voltage at the GND pin.

**ELECTRICAL CHARACTERISTICS LM3490-12, LM3490-15**

$V_{IN} = V_{NOM} + 1.5V$  unless otherwise noted. Typical and limits appearing in normal type apply for  $T_A = T_J = 25^\circ C$ . Limits appearing in boldface type apply over the entire junction temperature range for operation,  $-40$  to  $+125^\circ C$ <sup>(1)(2)(3)</sup>

Nominal Output Voltage ( $V_{NOM}$ )			12V		15V		Units
Symbol	Parameter	Conditions	Typical	Limit	Typical	Limit	
$V_{OUT}$	Output Voltage	$1\text{ mA} \leq I_{OUT} \leq 100\text{ mA}$	12.00	11.52 <b>11.40</b> 12.48 <b>12.60</b>	15.00	14.40 <b>14.25</b> 15.60 <b>15.75</b>	V V(min) V(min) V(max) V(max)
$\Delta V_{OUT}$	Line Regulation	$V_{NOM} + 1.5V \leq V_{IN} \leq 30V$ , $I_{OUT} = 1\text{ mA}$	14	<b>40</b>	16	<b>40</b>	mV mV(max)
$\Delta V_{OUT}$	Load Regulation	$10\text{ mA} \leq I_{OUT} \leq 100\text{ mA}$	36	<b>60</b>	45	<b>75</b>	mV mV(max)
$I_{GND}$	Ground Pin Current	$V_{NOM} + 1.5V \leq V_{IN} \leq 30V$ , No Load					
		$V_{ON/OFF} = 5V$	2	<b>4</b>	2	<b>4</b>	mA mA(max)
		$V_{ON/OFF} = 0V$	0.1	<b>5</b>	0.1	<b>5</b>	$\mu A$ $\mu A$ (max)
$V_{IN} - V_{OUT}$	Dropout Voltage	$I_{OUT} = 10\text{ mA}$	0.7	0.9 <b>1.0</b>	0.7	0.9 <b>1.0</b>	V V(max) V(max)
		$I_{OUT} = 100\text{ mA}$	0.9	1.1 <b>1.2</b>	0.9	1.1 <b>1.2</b>	V V(max) V(max)
$e_n$	Output Noise Voltage	$V_{IN} = 10V$ , Bandwidth: 10 Hz to 100 kHz	360		450		$\mu V_{rms}$
$V_{IL}$	Maximum Low Level Input Voltage at ON/OFF			<b>0.2</b>		<b>0.2</b>	V(max)
$V_{IH}$	Minimum High Level Input Voltage at ON/OFF			<b>2.0</b>		<b>2.0</b>	V(min)
$I_{IL}$		$V_{ON/OFF} = 0V$		<b>-1</b>		<b>-1</b>	$\mu A$ (max)
$I_{IH}$		$V_{ON/OFF} = 5V$	1	<b>20</b>	1	<b>20</b>	$\mu A$ $\mu A$ (max)

- (1) A typical is the center of characterization data taken with  $T_A = T_J = 25^\circ C$ . Typical values are not ensured.
- (2) All limits are specified. All electrical characteristics having room-temperature limits are tested during production with  $T_A = T_J = 25^\circ C$ . All hot and cold limits are specified by correlating the electrical characteristics to process and temperature variations and applying statistical process control.
- (3) All voltages except dropout are with respect to the voltage at the GND pin.

**TYPICAL PERFORMANCE CHARACTERISTICS**

Unless indicated otherwise,  $V_{IN} = V_{NOM} + 1.5V$ ,  $C_{IN} = 0.1 \mu F$ ,  $C_{OUT} = 0.1 \mu F$ , and  $T_A = 25^\circ C$ .

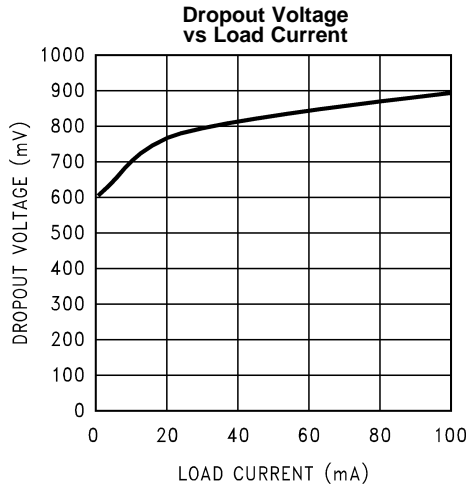

Figure 2.

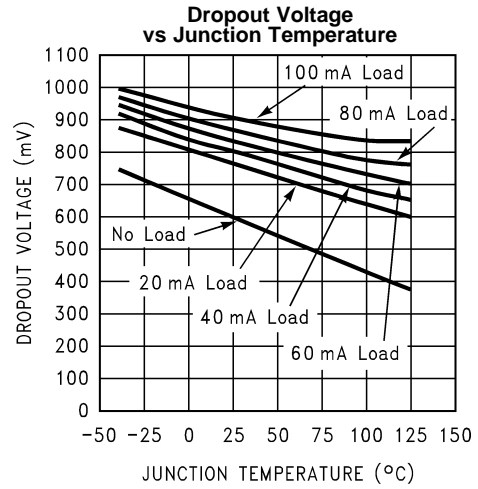

Figure 3.

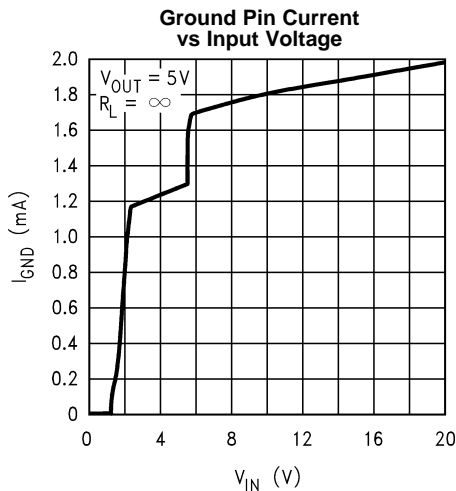

Figure 4.

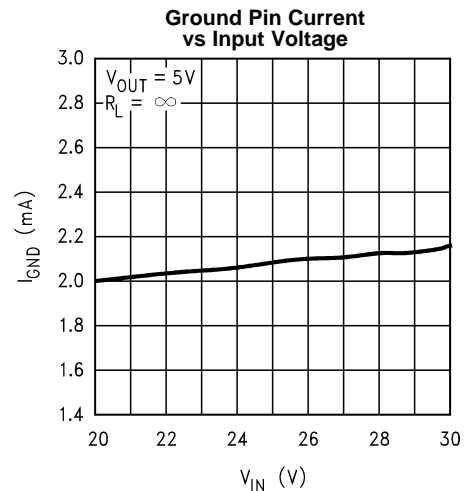

Figure 5.

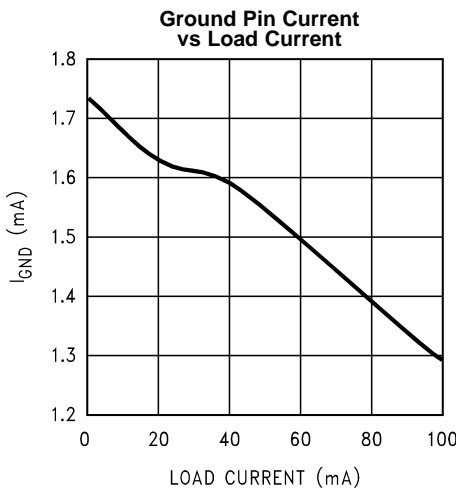

Figure 6.

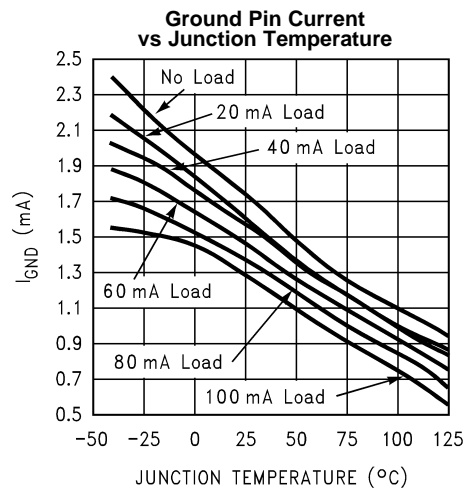

Figure 7.

**TYPICAL PERFORMANCE CHARACTERISTICS (continued)**

Unless indicated otherwise,  $V_{IN} = V_{NOM} + 1.5V$ ,  $C_{IN} = 0.1 \mu F$ ,  $C_{OUT} = 0.1 \mu F$ , and  $T_A = 25^\circ C$ .

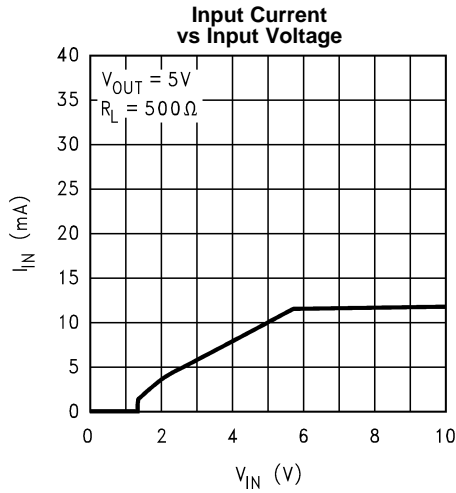

Figure 8.

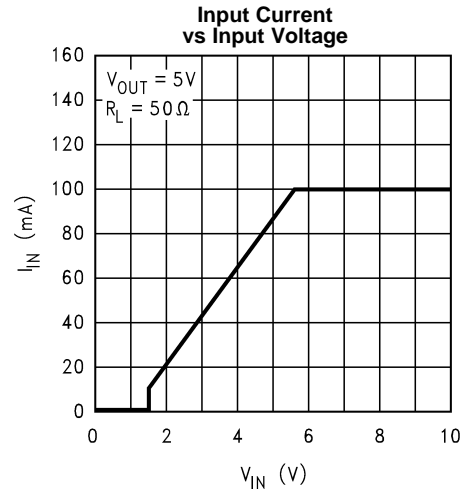
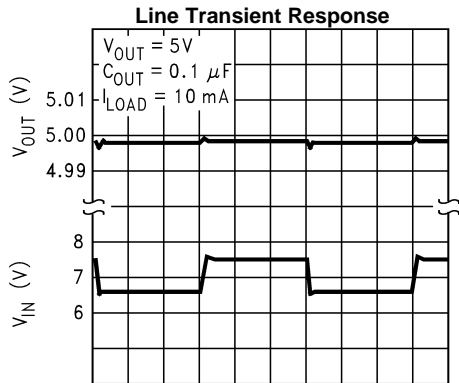
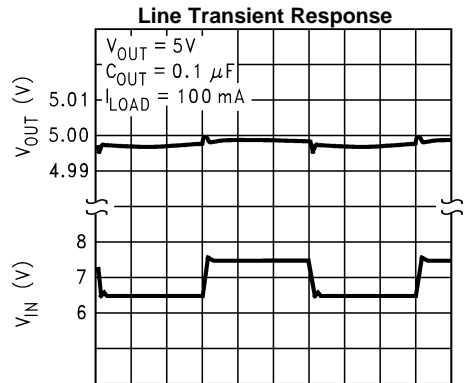

Figure 9.



200  $\mu s$ /Div  
Figure 10.



200  $\mu s$ /Div  
Figure 11.

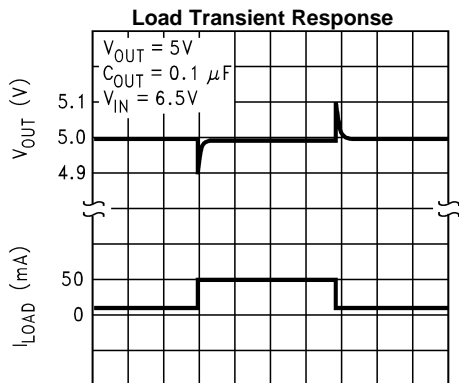

50  $\mu s$ /Div  
Figure 12.

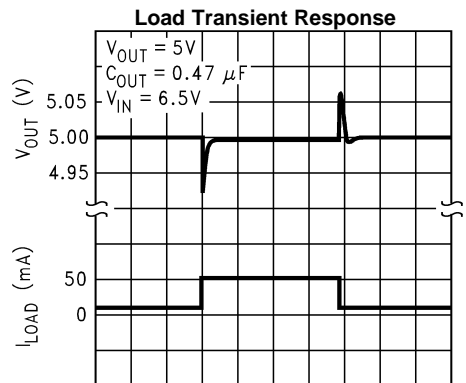

50  $\mu s$ /Div  
Figure 13.

**TYPICAL PERFORMANCE CHARACTERISTICS (continued)**

Unless indicated otherwise,  $V_{IN} = V_{NOM} + 1.5V$ ,  $C_{IN} = 0.1 \mu F$ ,  $C_{OUT} = 0.1 \mu F$ , and  $T_A = 25^\circ C$ .

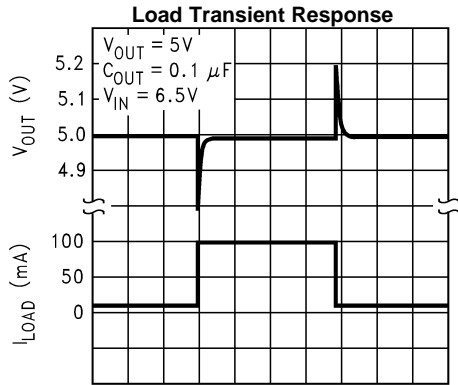

50  $\mu s$ /Div  
Figure 14.

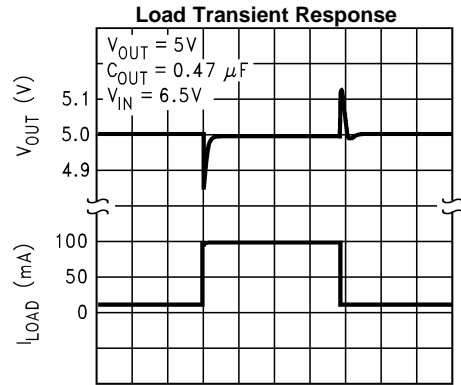

50  $\mu s$ /Div  
Figure 15.

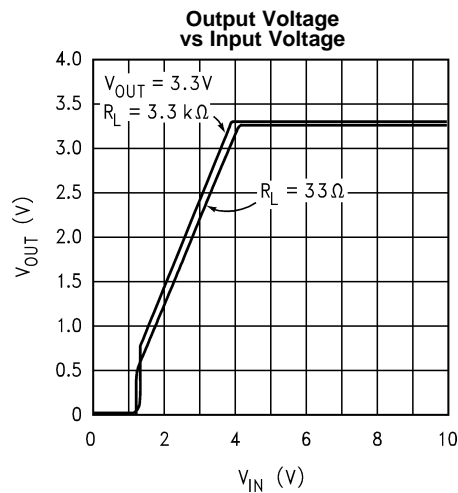

Figure 16.

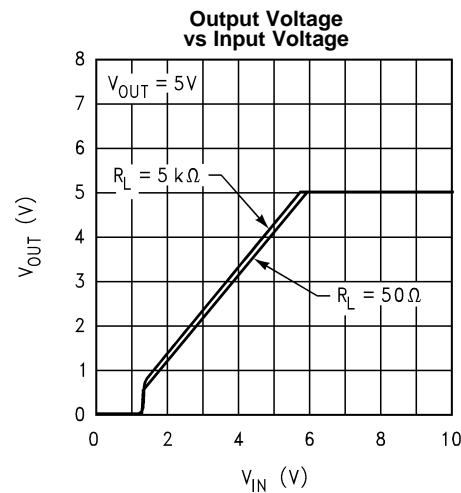

Figure 17.

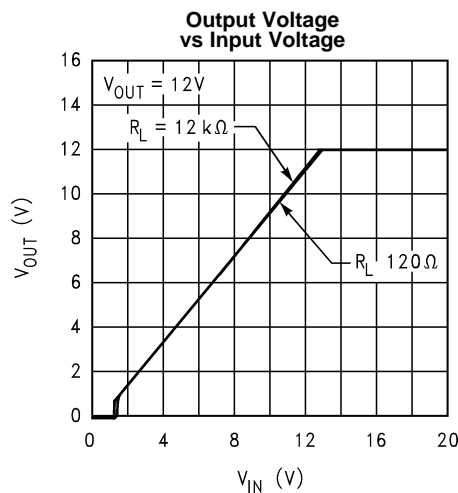

Figure 18.

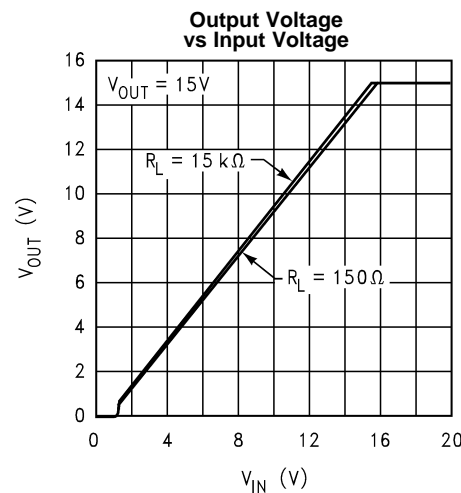

Figure 19.

**TYPICAL PERFORMANCE CHARACTERISTICS (continued)**

Unless indicated otherwise,  $V_{IN} = V_{NOM} + 1.5V$ ,  $C_{IN} = 0.1 \mu F$ ,  $C_{OUT} = 0.1 \mu F$ , and  $T_A = 25^\circ C$ .

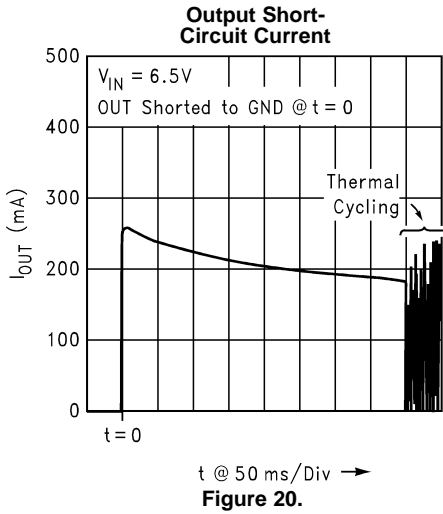

Figure 20.

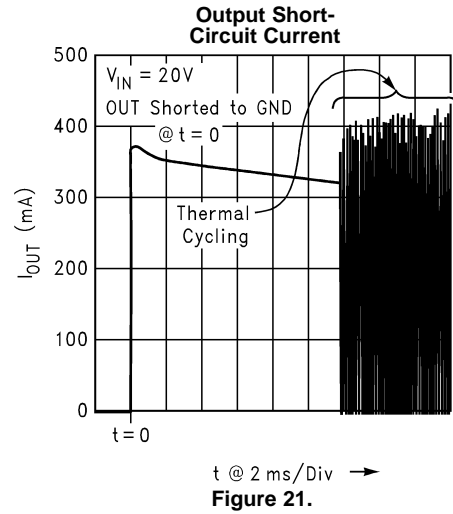

Figure 21.

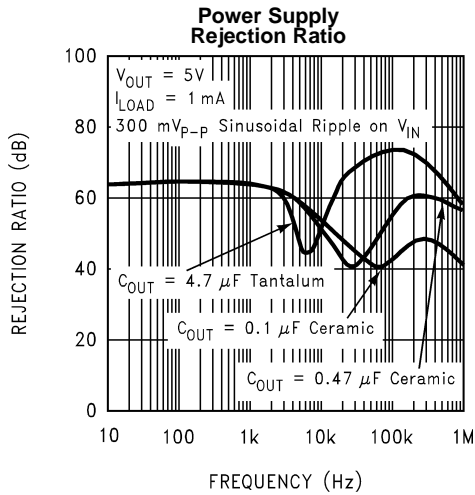

Figure 22.

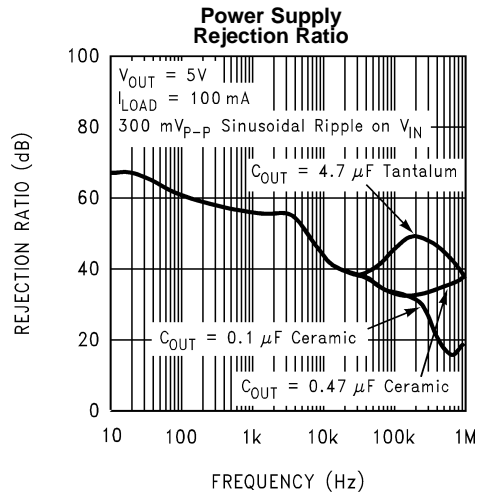

Figure 23.

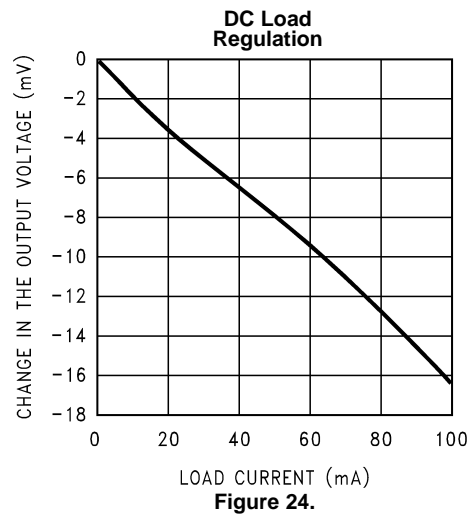

Figure 24.

## APPLICATIONS INFORMATION

### ON/OFF Pin

The LM3490 features a logic controlled ON/OFF pin that will allow the output voltage to be disabled, or enabled, as needed. The defined operating voltage range for this pin is 0.0V to 5.0V. The ON/OFF pin can not be left floating, as the output status cannot be ensured. Additionally, the ON/OFF pin should not be biased below ground potential as unpredictable device behavior may occur.



Pulling the ON/OFF pin voltage to a value between the  $V_{IH}$  threshold and 5.0V will enable the output voltage. Pulling the ON/OFF pin voltage to a value between the  $V_{IL}$  threshold and Ground potential will disable the output voltage. Although the ON/OFF threshold is typically 725mV, and has no hysteresis, the ON/OFF signal must rise and fall, cleanly and promptly, from voltage levels that are below the  $V_{IL}$  threshold and above the  $V_{IH}$  threshold.

The ON/OFF pin has no internal pull-up or pull-down to establish a default condition and, as a result, this pin must be terminated, either actively or passively, to an appropriate voltage level.

## REVISION HISTORY

Changes from Revision D (April 2013) to Revision E	Page
• Changed layout of National Data Sheet to TI format .....	<a href="#">9</a>

**PACKAGING INFORMATION**

Orderable Device	Status (1)	Package Type	Package Drawing	Pins	Package Qty	Eco Plan (2)	Lead/Ball Finish (6)	MSL Peak Temp (3)	Op Temp (°C)	Device Marking (4/5)	Samples
LM3490IM5-12	NRND	SOT-23	DBV	5	1000	TBD	Call TI	Call TI	-40 to 125	L80B	
LM3490IM5-12/NOPB	ACTIVE	SOT-23	DBV	5	1000	Green (RoHS & no Sb/Br)	CU SN	Level-1-260C-UNLIM	-40 to 125	L80B	
LM3490IM5-3.3	NRND	SOT-23	DBV	5	1000	TBD	Call TI	Call TI	-40 to 125	L78B	
LM3490IM5-3.3/NOPB	ACTIVE	SOT-23	DBV	5	1000	Green (RoHS & no Sb/Br)	CU SN	Level-1-260C-UNLIM	-40 to 125	L78B	
LM3490IM5-5.0/NOPB	ACTIVE	SOT-23	DBV	5	1000	Green (RoHS & no Sb/Br)	CU SN	Level-1-260C-UNLIM	-40 to 125	L79B	
LM3490IM5X-12/NOPB	ACTIVE	SOT-23	DBV	5	3000	Green (RoHS & no Sb/Br)	CU SN	Level-1-260C-UNLIM	-40 to 125	L80B	
LM3490IM5X-5.0	NRND	SOT-23	DBV	5		TBD	Call TI	Call TI	-40 to 125	L79B	
LM3490IM5X-5.0/NOPB	ACTIVE	SOT-23	DBV	5	3000	Green (RoHS & no Sb/Br)	CU SN	Level-1-260C-UNLIM	-40 to 125	L79B	

(1) The marketing status values are defined as follows:

**ACTIVE:** Product device recommended for new designs.

**LIFEBUY:** TI has announced that the device will be discontinued, and a lifetime-buy period is in effect.

**NRND:** Not recommended for new designs. Device is in production to support existing customers, but TI does not recommend using this part in a new design.

**PREVIEW:** Device has been announced but is not in production. Samples may or may not be available.

**OBSOLETE:** TI has discontinued the production of the device.

(2) Eco Plan - The planned eco-friendly classification: Pb-Free (RoHS), Pb-Free (RoHS Exempt), or Green (RoHS & no Sb/Br) - please check <http://www.ti.com/productcontent> for the latest availability information and additional product content details.

**TBD:** The Pb-Free/Green conversion plan has not been defined.

**Pb-Free (RoHS):** TI's terms "Lead-Free" or "Pb-Free" mean semiconductor products that are compatible with the current RoHS requirements for all 6 substances, including the requirement that lead not exceed 0.1% by weight in homogeneous materials. Where designed to be soldered at high temperatures, TI Pb-Free products are suitable for use in specified lead-free processes.

**Pb-Free (RoHS Exempt):** This component has a RoHS exemption for either 1) lead-based flip-chip solder bumps used between the die and package, or 2) lead-based die adhesive used between the die and leadframe. The component is otherwise considered Pb-Free (RoHS compatible) as defined above.

**Green (RoHS & no Sb/Br):** TI defines "Green" to mean Pb-Free (RoHS compatible), and free of Bromine (Br) and Antimony (Sb) based flame retardants (Br or Sb do not exceed 0.1% by weight in homogeneous material)

(3) MSL, Peak Temp. - The Moisture Sensitivity Level rating according to the JEDEC industry standard classifications, and peak solder temperature.

(4) There may be additional marking, which relates to the logo, the lot trace code information, or the environmental category on the device.

<sup>(5)</sup> Multiple Device Markings will be inside parentheses. Only one Device Marking contained in parentheses and separated by a "-" will appear on a device. If a line is indented then it is a continuation of the previous line and the two combined represent the entire Device Marking for that device.

<sup>(6)</sup> Lead/Ball Finish - Orderable Devices may have multiple material finish options. Finish options are separated by a vertical ruled line. Lead/Ball Finish values may wrap to two lines if the finish value exceeds the maximum column width.

**Important Information and Disclaimer:**The information provided on this page represents TI's knowledge and belief as of the date that it is provided. TI bases its knowledge and belief on information provided by third parties, and makes no representation or warranty as to the accuracy of such information. Efforts are underway to better integrate information from third parties. TI has taken and continues to take reasonable steps to provide representative and accurate information but may not have conducted destructive testing or chemical analysis on incoming materials and chemicals. TI and TI suppliers consider certain information to be proprietary, and thus CAS numbers and other limited information may not be available for release.

In no event shall TI's liability arising out of such information exceed the total purchase price of the TI part(s) at issue in this document sold by TI to Customer on an annual basis.

**TAPE AND REEL INFORMATION**

**QUADRANT ASSIGNMENTS FOR PIN 1 ORIENTATION IN TAPE**

\*All dimensions are nominal

Device	Package Type	Package Drawing	Pins	SPQ	Reel Diameter (mm)	Reel Width W1 (mm)	A0 (mm)	B0 (mm)	K0 (mm)	P1 (mm)	W (mm)	Pin1 Quadrant
LM3490IM5-12	SOT-23	DBV	5	1000	178.0	8.4	3.2	3.2	1.4	4.0	8.0	Q3
LM3490IM5-12/NOPB	SOT-23	DBV	5	1000	178.0	8.4	3.2	3.2	1.4	4.0	8.0	Q3
LM3490IM5-3.3	SOT-23	DBV	5	1000	178.0	8.4	3.2	3.2	1.4	4.0	8.0	Q3
LM3490IM5-3.3/NOPB	SOT-23	DBV	5	1000	178.0	8.4	3.2	3.2	1.4	4.0	8.0	Q3
LM3490IM5-5.0/NOPB	SOT-23	DBV	5	1000	178.0	8.4	3.2	3.2	1.4	4.0	8.0	Q3
LM3490IM5X-12/NOPB	SOT-23	DBV	5	3000	178.0	8.4	3.2	3.2	1.4	4.0	8.0	Q3
LM3490IM5X-5.0/NOPB	SOT-23	DBV	5	3000	178.0	8.4	3.2	3.2	1.4	4.0	8.0	Q3

**TAPE AND REEL BOX DIMENSIONS**

\*All dimensions are nominal

Device	Package Type	Package Drawing	Pins	SPQ	Length (mm)	Width (mm)	Height (mm)
LM3490IM5-12	SOT-23	DBV	5	1000	210.0	185.0	35.0
LM3490IM5-12/NOPB	SOT-23	DBV	5	1000	210.0	185.0	35.0
LM3490IM5-3.3	SOT-23	DBV	5	1000	210.0	185.0	35.0
LM3490IM5-3.3/NOPB	SOT-23	DBV	5	1000	210.0	185.0	35.0
LM3490IM5-5.0/NOPB	SOT-23	DBV	5	1000	210.0	185.0	35.0
LM3490IM5X-12/NOPB	SOT-23	DBV	5	3000	210.0	185.0	35.0
LM3490IM5X-5.0/NOPB	SOT-23	DBV	5	3000	210.0	185.0	35.0

DBV (R-PDSO-G5)

PLASTIC SMALL-OUTLINE PACKAGE

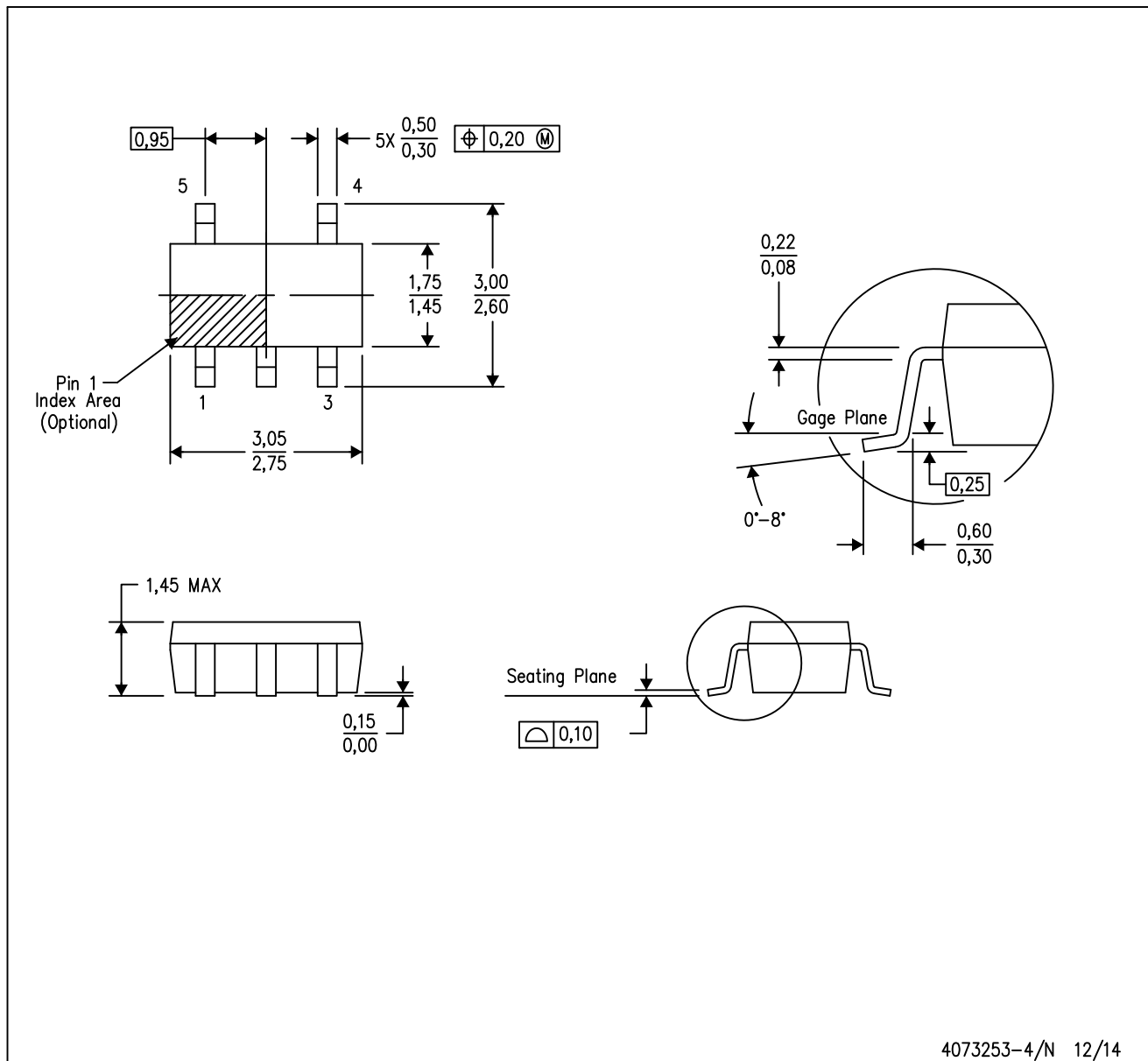

- NOTES:
- A. All linear dimensions are in millimeters.
  - B. This drawing is subject to change without notice.
  - C. Body dimensions do not include mold flash or protrusion. Mold flash and protrusion shall not exceed 0.15 per side.
  - D. Falls within JEDEC MO-178 Variation AA.

DBV (R-PDSO-G5)

PLASTIC SMALL OUTLINE



- NOTES:
- A. All linear dimensions are in millimeters.
  - B. This drawing is subject to change without notice.
  - C. Customers should place a note on the circuit board fabrication drawing not to alter the center solder mask defined pad.
  - D. Publication IPC-7351 is recommended for alternate designs.
  - E. Laser cutting apertures with trapezoidal walls and also rounding corners will offer better paste release. Customers should contact their board assembly site for stencil design recommendations. Example stencil design based on a 50% volumetric metal load solder paste. Refer to IPC-7525 for other stencil recommendations.

## IMPORTANT NOTICE

Texas Instruments Incorporated and its subsidiaries (TI) reserve the right to make corrections, enhancements, improvements and other changes to its semiconductor products and services per JESD46, latest issue, and to discontinue any product or service per JESD48, latest issue. Buyers should obtain the latest relevant information before placing orders and should verify that such information is current and complete. All semiconductor products (also referred to herein as "components") are sold subject to TI's terms and conditions of sale supplied at the time of order acknowledgment.

TI warrants performance of its components to the specifications applicable at the time of sale, in accordance with the warranty in TI's terms and conditions of sale of semiconductor products. Testing and other quality control techniques are used to the extent TI deems necessary to support this warranty. Except where mandated by applicable law, testing of all parameters of each component is not necessarily performed.

TI assumes no liability for applications assistance or the design of Buyers' products. Buyers are responsible for their products and applications using TI components. To minimize the risks associated with Buyers' products and applications, Buyers should provide adequate design and operating safeguards.

TI does not warrant or represent that any license, either express or implied, is granted under any patent right, copyright, mask work right, or other intellectual property right relating to any combination, machine, or process in which TI components or services are used. Information published by TI regarding third-party products or services does not constitute a license to use such products or services or a warranty or endorsement thereof. Use of such information may require a license from a third party under the patents or other intellectual property of the third party, or a license from TI under the patents or other intellectual property of TI.

Reproduction of significant portions of TI information in TI data books or data sheets is permissible only if reproduction is without alteration and is accompanied by all associated warranties, conditions, limitations, and notices. TI is not responsible or liable for such altered documentation. Information of third parties may be subject to additional restrictions.

Resale of TI components or services with statements different from or beyond the parameters stated by TI for that component or service voids all express and any implied warranties for the associated TI component or service and is an unfair and deceptive business practice. TI is not responsible or liable for any such statements.

Buyer acknowledges and agrees that it is solely responsible for compliance with all legal, regulatory and safety-related requirements concerning its products, and any use of TI components in its applications, notwithstanding any applications-related information or support that may be provided by TI. Buyer represents and agrees that it has all the necessary expertise to create and implement safeguards which anticipate dangerous consequences of failures, monitor failures and their consequences, lessen the likelihood of failures that might cause harm and take appropriate remedial actions. Buyer will fully indemnify TI and its representatives against any damages arising out of the use of any TI components in safety-critical applications.

In some cases, TI components may be promoted specifically to facilitate safety-related applications. With such components, TI's goal is to help enable customers to design and create their own end-product solutions that meet applicable functional safety standards and requirements. Nonetheless, such components are subject to these terms.

No TI components are authorized for use in FDA Class III (or similar life-critical medical equipment) unless authorized officers of the parties have executed a special agreement specifically governing such use.

Only those TI components which TI has specifically designated as military grade or "enhanced plastic" are designed and intended for use in military/aerospace applications or environments. Buyer acknowledges and agrees that any military or aerospace use of TI components which have **not** been so designated is solely at the Buyer's risk, and that Buyer is solely responsible for compliance with all legal and regulatory requirements in connection with such use.

TI has specifically designated certain components as meeting ISO/TS16949 requirements, mainly for automotive use. In any case of use of non-designated products, TI will not be responsible for any failure to meet ISO/TS16949.

### Products

Audio	<a href="http://www.ti.com/audio">www.ti.com/audio</a>
Amplifiers	<a href="http://amplifier.ti.com">amplifier.ti.com</a>
Data Converters	<a href="http://dataconverter.ti.com">dataconverter.ti.com</a>
DLP® Products	<a href="http://www.dlp.com">www.dlp.com</a>
DSP	<a href="http://dsp.ti.com">dsp.ti.com</a>
Clocks and Timers	<a href="http://www.ti.com/clocks">www.ti.com/clocks</a>
Interface	<a href="http://interface.ti.com">interface.ti.com</a>
Logic	<a href="http://logic.ti.com">logic.ti.com</a>
Power Mgmt	<a href="http://power.ti.com">power.ti.com</a>
Microcontrollers	<a href="http://microcontroller.ti.com">microcontroller.ti.com</a>
RFID	<a href="http://www.ti-rfid.com">www.ti-rfid.com</a>
OMAP Applications Processors	<a href="http://www.ti.com/omap">www.ti.com/omap</a>
Wireless Connectivity	<a href="http://www.ti.com/wirelessconnectivity">www.ti.com/wirelessconnectivity</a>

### Applications

Automotive and Transportation	<a href="http://www.ti.com/automotive">www.ti.com/automotive</a>
Communications and Telecom	<a href="http://www.ti.com/communications">www.ti.com/communications</a>
Computers and Peripherals	<a href="http://www.ti.com/computers">www.ti.com/computers</a>
Consumer Electronics	<a href="http://www.ti.com/consumer-apps">www.ti.com/consumer-apps</a>
Energy and Lighting	<a href="http://www.ti.com/energy">www.ti.com/energy</a>
Industrial	<a href="http://www.ti.com/industrial">www.ti.com/industrial</a>
Medical	<a href="http://www.ti.com/medical">www.ti.com/medical</a>
Security	<a href="http://www.ti.com/security">www.ti.com/security</a>
Space, Avionics and Defense	<a href="http://www.ti.com/space-avionics-defense">www.ti.com/space-avionics-defense</a>
Video and Imaging	<a href="http://www.ti.com/video">www.ti.com/video</a>

### TI E2E Community

[e2e.ti.com](http://e2e.ti.com)