

## LM9036 Ultra-Low Quiescent Current Voltage Regulator

Check for Samples: [LM9036](#)

### FEATURES

- Ultra low Ground Pin Current ( $I_{GND} \leq 25\mu A$  for  $I_{OUT} = 0.1mA$ )
- Fixed 5V, 3.3V, 50mA Output
- Output Tolerance  $\pm 5\%$  Over Line, Load, and Temperature
- Dropout Voltage Typically 200mV @  $I_{OUT} = 50mA$
- $-45V$  Reverse Transient Protection
- Internal Short Circuit Current Limit
- Internal Thermal Shutdown Protection
- 40V Operating Voltage Limit

### DESCRIPTION

The LM9036 ultra-low quiescent current regulator features low dropout voltage and low current in the standby mode. With less than  $25\mu A$  Ground Pin current at a  $0.1mA$  load, the LM9036 is ideally suited for automotive and other battery operated systems. The LM9036 retains all of the features that are common to low dropout regulators including a low dropout PNP pass device, short circuit protection, reverse battery protection, and thermal shutdown. The LM9036 has a 40V maximum operating voltage limit, a  $-40^{\circ}C$  to  $+125^{\circ}C$  operating temperature range, and  $\pm 5\%$  output voltage tolerance over the entire output current, input voltage, and temperature range.

### Typical Application

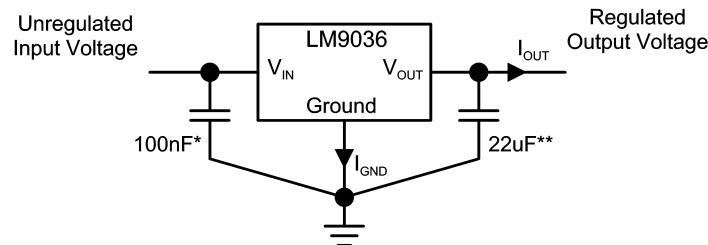

\* Required if regulator is located more than 2" from power supply filter capacitor.

\*\* Required for stability. Must be rated over intended operating temperature range. Effective series resistance (ESR) is critical, see Electrical Characteristics. Locate capacitor as close as possible to the regulator output and ground pins. Capacitance may be increased without bound.

### Connection Diagram

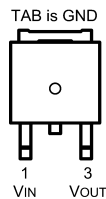

**Figure 1. PFM  
Top View**

**Order Number LM9036DT-5.0, LM9036DTX-5.0,  
LM9036DT-3.3, LM9036DTX-3.3  
See NS Package Number NDP0003B**



Please be aware that an important notice concerning availability, standard warranty, and use in critical applications of Texas Instruments semiconductor products and disclaimers thereto appears at the end of this data sheet.

All trademarks are the property of their respective owners.

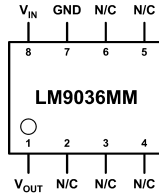

**Figure 2. 8 Lead VSSOP  
Top View**

**LM9036MM-3.3, LM9036MMX-3.3, LM9036MM-5.0,  
LM9036MMX-5.0**

**See NS Package Number DGK**

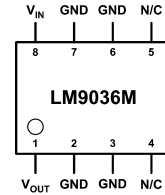

**Figure 3. 8 Lead SOIC  
Top View**

**LM9036M-3.3, LM9036MX-3.3, LM9036M-5.0,  
LM9036MX-5.0**

**See NS Package Number D**



These devices have limited built-in ESD protection. The leads should be shorted together or the device placed in conductive foam during storage or handling to prevent electrostatic damage to the MOS gates.

### Absolute Maximum Ratings<sup>(1)(2)</sup>

|                                       |                    |
|---------------------------------------|--------------------|
| Input Voltage (Survival)              | +55V, -45V         |
| ESD Susceptibility <sup>(3)</sup>     | ±1.9kV             |
| Power Dissipation <sup>(4)</sup>      | Internally limited |
| Junction Temperature ( $T_{Jmax}$ )   | 150°C              |
| Storage Temperature Range             | -65°C to +150°C    |
| Lead Temperature (Soldering, 10 sec.) | 260°C              |

- (1) Absolute Maximum Ratings indicate limits beyond which damage to the device may occur. DC and AC electrical specifications do not apply when operating the device beyond its specified operating ratings.
- (2) If Military/Aerospace specified devices are required, please contact the Texas Instruments Sales Office/Distributors for availability and specifications.
- (3) Human body model, 100pF discharge through a 1.5kΩ resistor.
- (4) The maximum power dissipation is a function of  $T_{Jmax}$ ,  $\theta_{JA}$ , and  $T_A$ . The maximum allowable power dissipation at any ambient temperature is  $P_D = (T_{Jmax} - T_A)/\theta_{JA}$ . If this dissipation is exceeded, the die temperature will rise above 150°C and the LM9036 will go into thermal shutdown.

### Operating Ratings

|   |                 |
|---|-----------------|
| Operating Temperature Range                 | -40°C to +125°C |
| Maximum Input Voltage (Operational)         | 40V             |
| SOIC-8 (D) $\theta_{JA}$ <sup>(1)</sup>     | 140°C/W         |
| PFM (NDP0003B) $\theta_{JA}$ <sup>(1)</sup> | 125°C/W         |
| PFM (NDP0003B) $\theta_{JA}$ <sup>(2)</sup> | 50°C/W          |
| PFM (NDP0003B) $\theta_{JC}$ <sup>(1)</sup> | 11°C/W          |
| MSO-8 (DGK) $\theta_{JA}$ <sup>(1)</sup>    | 200°C/W         |

- (1) Worst case (Free Air) per EIA / JESD51-3.
- (2) Typical  $\theta_{JA}$  with 1 square inch of 2oz copper pad area directly under the ground tab.

### Electrical Characteristics - LM9036-5.0

$V_{IN} = 14V$ ,  $I_{OUT} = 10\text{ mA}$ ,  $T_J = 25^\circ\text{C}$ , unless otherwise specified. **Boldface** limits apply over entire operating temperature range

| Parameter                               | Conditions   | Min<br>(1)  | Typical<br>(2) | Max<br>(1)  | Units         |
|---|--|-------------|----------------|-------------|---------------|
| Output Voltage ( $V_{OUT}$ )            |  | 4.80        | 5.00           | 5.20        | V             |
|   | $5.5V \leq V_{IN} \leq 26V$ ,<br>$0.1\text{mA} \leq I_{OUT} \leq 50\text{mA}$ (3)        | <b>4.75</b> | <b>5.00</b>    | <b>5.25</b> |               |
| Quiescent Current ( $I_{GND}$ )         | $I_{OUT} = 0.1\text{mA}$ , $8V \leq V_{IN} \leq 24V$                                     |             | 20             | 25          | $\mu\text{A}$ |
|   | $I_{OUT} = 1\text{mA}$ , $8V \leq V_{IN} \leq 24V$                                       |             | 50             | 100         |               |
|   | $I_{OUT} = 10\text{mA}$ , $8V \leq V_{IN} \leq 24V$                                      |             | 0.3            | 0.5         | mA            |
|   | $I_{OUT} = 50\text{mA}$ , $8V \leq V_{IN} \leq 24V$                                      |             | 2.0            | 2.5         |               |
| Line Regulation ( $\Delta V_{OUT}$ )    | $6V \leq V_{IN} \leq 40V$ , $I_{OUT} = 1\text{mA}$                                       |             | 10             | 30          | mV            |
| Load Regulation ( $\Delta V_{OUT}$ )    | $0.1\text{mA} \leq I_{OUT} \leq 5\text{mA}$  |             | 10             | 30          | mV            |
|   | $5\text{mA} \leq I_{OUT} \leq 50\text{mA}$   |             | 10             | 30          | mV            |
| Dropout Voltage ( $\Delta V_{OUT}$ )    | $I_{OUT} = 0.1\text{mA}$   |             | 0.05           | 0.10        | V             |
|   | $I_{OUT} = 50\text{mA}$  |             | 0.20           | 0.40        | V             |
| Short Circuit Current ( $I_{SC}$ )      | $V_{OUT} = 0V$   | 65          | 120            | 250         | mA            |
| Ripple Rejection (PSRR)                 | $V_{\text{ripple}} = 1V_{\text{rms}}$ , $F_{\text{ripple}} = 120\text{Hz}$               | -40         | -60            |             | dB            |
| Output Bypass Capacitance ( $C_{OUT}$ ) | $0.3\Omega \leq \text{ESR} \leq 8\Omega$<br>$0.1\text{mA} \leq I_{OUT} \leq 50\text{mA}$ | 10          | 22             |             | $\mu\text{F}$ |

(1) Tested limits are specified to TI's AOQL (Average Outgoing Quality Level) and 100% tested.

(2) Typicals are at  $25^\circ\text{C}$  (unless otherwise specified) and represent the most likely parametric norm.

(3) To ensure constant junction temperature, pulse testing is used.

### Electrical Characteristics - LM9036-3.3

$V_{IN} = 14V$ ,  $I_{OUT} = 10\text{ mA}$ ,  $T_J = 25^\circ\text{C}$ , unless otherwise specified. **Boldface** limits apply over entire operating temperature range

| Parameter                               | Conditions   | Min<br>(1)   | Typical<br>(2) | Max<br>(1)   | Units         |
|---|--|--------------|----------------|--------------|---------------|
| Output Voltage ( $V_{OUT}$ )            |  | 3.168        | 3.30           | 3.432        | V             |
|   | $5.5V \leq V_{IN} \leq 26V$ ,<br>$0.1\text{mA} \leq I_{OUT} \leq 50\text{mA}$ (3)        | <b>3.135</b> | <b>3.30</b>    | <b>3.465</b> |               |
| Quiescent Current ( $I_{GND}$ )         | $I_{OUT} = 0.1\text{mA}$ , $8V \leq V_{IN} \leq 24V$                                     |              | 20             | 25           | $\mu\text{A}$ |
|   | $I_{OUT} = 1\text{mA}$ , $8V \leq V_{IN} \leq 24V$                                       |              | 50             | 100          |               |
|   | $I_{OUT} = 10\text{mA}$ , $8V \leq V_{IN} \leq 24V$                                      |              | 0.3            | 0.5          | mA            |
|   | $I_{OUT} = 50\text{mA}$ , $8V \leq V_{IN} \leq 24V$                                      |              | 2.0            | 2.5          |               |
| Line Regulation ( $\Delta V_{OUT}$ )    | $6V \leq V_{IN} \leq 40V$ , $I_{OUT} = 1\text{mA}$                                       |              | 10             | 30           | mV            |
| Load Regulation ( $\Delta V_{OUT}$ )    | $0.1\text{mA} \leq I_{OUT} \leq 5\text{mA}$  |              | 10             | 30           | mV            |
|   | $5\text{mA} \leq I_{OUT} \leq 50\text{mA}$   |              | 10             | 30           | mV            |
| Dropout Voltage ( $\Delta V_{OUT}$ )    | $I_{OUT} = 0.1\text{mA}$   |              | 0.05           | 0.10         | V             |
|   | $I_{OUT} = 50\text{mA}$  |              | 0.20           | 0.40         | V             |
| Short Circuit Current ( $I_{SC}$ )      | $V_{OUT} = 0V$   | 65           | 120            | 250          | mA            |
| Ripple Rejection (PSRR)                 | $V_{\text{ripple}} = 1V_{\text{rms}}$ , $F_{\text{ripple}} = 120\text{Hz}$               | -40          | -60            |              | dB            |
| Output Bypass Capacitance ( $C_{OUT}$ ) | $0.3\Omega \leq \text{ESR} \leq 8\Omega$<br>$0.1\text{mA} \leq I_{OUT} \leq 50\text{mA}$ | 22           | 33             |              | $\mu\text{F}$ |

(1) Tested limits are specified to TI's AOQL (Average Outgoing Quality Level) and 100% tested.

(2) Typicals are at  $25^\circ\text{C}$  (unless otherwise specified) and represent the most likely parametric norm.

(3) To ensure constant junction temperature, pulse testing is used.

Typical Performance Characteristics

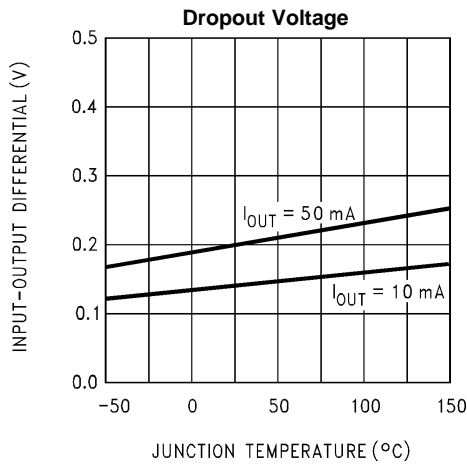

Figure 4.

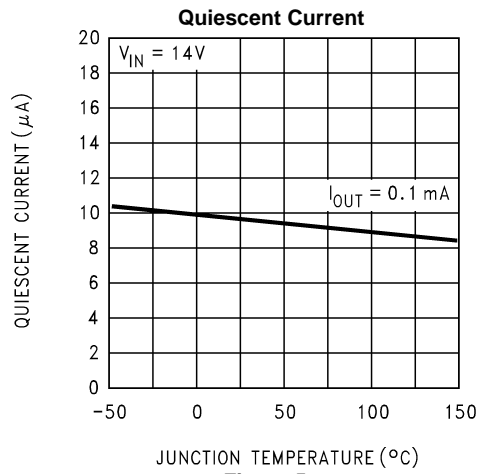

Figure 5.

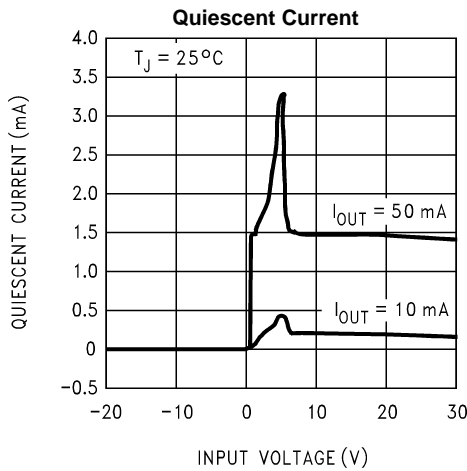

Figure 6.

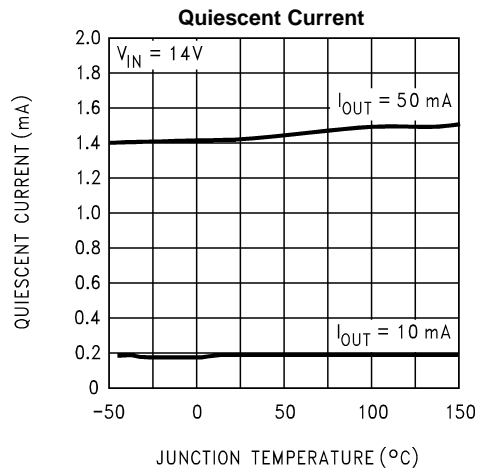

Figure 7.

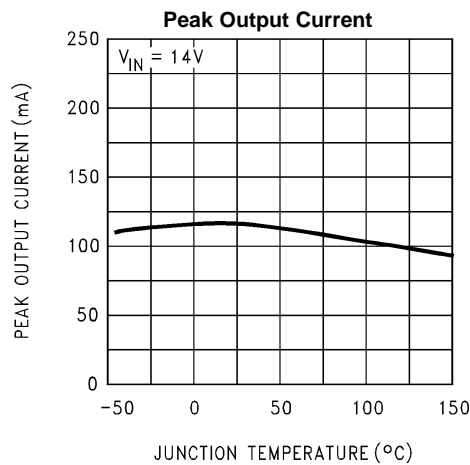

Figure 8.

## APPLICATIONS INFORMATION

Unlike other PNP low dropout regulators, the LM9036 remains fully operational to 40V. Owing to power dissipation characteristics of the package, full output current cannot be ensured for all combinations of ambient temperature and input voltage.

The junction to ambient thermal resistance  $\theta_{JA}$  rating has two distinct components: the junction to case thermal resistance rating  $\theta_{JC}$ ; and the case to ambient thermal resistance rating  $\theta_{CA}$ . The relationship is defined as:  $\theta_{JA} = \theta_{JC} + \theta_{CA}$ .

On the PFM package the ground tab is thermally connected to the backside of the die. Adding 1 square inch of 2 oz. copper pad area directly under the ground tab will improve the  $\theta_{JA}$  rating to approximately 50°C/W.

While the LM9036 has an internally set thermal shutdown point of typically 150°C, this is intended as a safety feature only. Continuous operation near the thermal shutdown temperature should be avoided as it may have a negative affect on the life of the device.

Using the  $\theta_{JA}$  for a LM9036DT mounted on a circuit board as defined at, see<sup>(1)</sup>, and using the formula for maximum allowable dissipation given in, see<sup>(2)</sup>, for an ambient temperature ( $T_A$ ) of +85°C, we find that  $P_{DMAX} = 1.3W$ . Including the small contribution of the quiescent current  $I_Q$  to the total power dissipation, the maximum input voltage (while still delivering 50mA output current) is 29.5V. The LM9036DT will go into thermal shutdown when attempting to deliver the full output current of 50mA, with an ambient temperature of +85°C, and the input voltage is greater than 29.5V. Similarly, with an ambient temperature of 25°C the  $P_{DMAX} = 2.5W$ , and the LM9036DT can deliver the full output current of 50mA with an input voltage of up to 40V.







While the LM9036 maintains regulation to 55V, it will not withstand a short circuit above 40V because of safe operating area limitations in the internal PNP pass device. Above 55V the LM9036 will break down with catastrophic effects on the regulator and possibly the load as well. Do not use this device in a design where the input operating voltage may exceed 40V, or where transients are likely to exceed 55V.

- (1) Typical  $\theta_{JA}$  with 1 square inch of 2oz copper pad area directly under the ground tab.
- (2) The maximum power dissipation is a function of  $T_{Jmax}$ ,  $\theta_{JA}$ , and  $T_A$ . The maximum allowable power dissipation at any ambient temperature is  $P_D = (T_{Jmax} - T_A)/\theta_{JA}$ . If this dissipation is exceeded, the die temperature will rise above 150°C and the LM9036 will go into thermal shutdown.

## REVISION HISTORY

| Changes from Revision D (March 2013) to Revision E         | Page              |
|--|-------------------|
| • Changed layout of National Data Sheet to TI format ..... | <a href="#">5</a> |

**PACKAGING INFORMATION**

| Orderable Device   | Status<br>(1) | Package Type | Package Drawing | Pins | Package Qty | Eco Plan<br>(2)         | Lead/Ball Finish<br>(6) | MSL Peak Temp<br>(3) | Op Temp (°C) | Device Marking<br>(4/5) | Samples   |
|--------------------|---------------|--------------|-----------------|------|-------------|-------------------------|-------------------------|----------------------|--------------|-------------------------|---|
| LM9036DT-5.0/NOPB  | ACTIVE        | TO-252       | NDP             | 3    | 75          | Green (RoHS & no Sb/Br) | CU SN                   | Level-2-260C-1 YEAR  | -40 to 125   | LM9036D<br>T-5.0        |  |
| LM9036DTX-5.0      | NRND          | TO-252       | NDP             | 3    |             | TBD                     | Call TI                 | Call TI              | -40 to 125   | LM9036D<br>T-5.0        |   |
| LM9036DTX-5.0/NOPB | ACTIVE        | TO-252       | NDP             | 3    | 2500        | Green (RoHS & no Sb/Br) | CU SN                   | Level-2-260C-1 YEAR  | -40 to 125   | LM9036D<br>T-5.0        |  |
| LM9036M-3.3/NOPB   | ACTIVE        | SOIC         | D               | 8    | 95          | Green (RoHS & no Sb/Br) | CU SN                   | Level-1-260C-UNLIM   | -40 to 125   | LM903<br>6M-3           |  |
| LM9036M-5.0        | NRND          | SOIC         | D               | 8    | 95          | TBD                     | Call TI                 | Call TI              | -40 to 125   | LM903<br>6M-5           |   |
| LM9036M-5.0/NOPB   | ACTIVE        | SOIC         | D               | 8    | 95          | Green (RoHS & no Sb/Br) | CU SN                   | Level-1-260C-UNLIM   | -40 to 125   | LM903<br>6M-5           |  |
| LM9036MM-3.3/NOPB  | ACTIVE        | VSSOP        | DGK             | 8    | 1000        | Green (RoHS & no Sb/Br) | CU SN                   | Level-1-260C-UNLIM   | -40 to 125   | KDB                     |  |
| LM9036MM-5.0/NOPB  | ACTIVE        | VSSOP        | DGK             | 8    | 1000        | Green (RoHS & no Sb/Br) | CU SN                   | Level-1-260C-UNLIM   | -40 to 125   | KDA                     |  |
| LM9036MX-3.3/NOPB  | ACTIVE        | SOIC         | D               | 8    | 2500        | Green (RoHS & no Sb/Br) | CU SN                   | Level-1-260C-UNLIM   | -40 to 125   | LM903<br>6M-3           |  |
| LM9036MX-5.0/NOPB  | ACTIVE        | SOIC         | D               | 8    | 2500        | Green (RoHS & no Sb/Br) | CU SN                   | Level-1-260C-UNLIM   | -40 to 125   | LM903<br>6M-5           |  |

(1) The marketing status values are defined as follows:

**ACTIVE:** Product device recommended for new designs.

**LIFEBUY:** TI has announced that the device will be discontinued, and a lifetime-buy period is in effect.

**NRND:** Not recommended for new designs. Device is in production to support existing customers, but TI does not recommend using this part in a new design.

**PREVIEW:** Device has been announced but is not in production. Samples may or may not be available.

**OBSOLETE:** TI has discontinued the production of the device.

(2) Eco Plan - The planned eco-friendly classification: Pb-Free (RoHS), Pb-Free (RoHS Exempt), or Green (RoHS & no Sb/Br) - please check <http://www.ti.com/productcontent> for the latest availability information and additional product content details.

**TBD:** The Pb-Free/Green conversion plan has not been defined.

**Pb-Free (RoHS):** TI's terms "Lead-Free" or "Pb-Free" mean semiconductor products that are compatible with the current RoHS requirements for all 6 substances, including the requirement that lead not exceed 0.1% by weight in homogeneous materials. Where designed to be soldered at high temperatures, TI Pb-Free products are suitable for use in specified lead-free processes.

**Pb-Free (RoHS Exempt):** This component has a RoHS exemption for either 1) lead-based flip-chip solder bumps used between the die and package, or 2) lead-based die adhesive used between the die and leadframe. The component is otherwise considered Pb-Free (RoHS compatible) as defined above.

**Green (RoHS & no Sb/Br):** TI defines "Green" to mean Pb-Free (RoHS compatible), and free of Bromine (Br) and Antimony (Sb) based flame retardants (Br or Sb do not exceed 0.1% by weight in homogeneous material)

- (3) MSL, Peak Temp. - The Moisture Sensitivity Level rating according to the JEDEC industry standard classifications, and peak solder temperature.
- (4) There may be additional marking, which relates to the logo, the lot trace code information, or the environmental category on the device.
- (5) Multiple Device Markings will be inside parentheses. Only one Device Marking contained in parentheses and separated by a "~" will appear on a device. If a line is indented then it is a continuation of the previous line and the two combined represent the entire Device Marking for that device.
- (6) Lead/Ball Finish - Orderable Devices may have multiple material finish options. Finish options are separated by a vertical ruled line. Lead/Ball Finish values may wrap to two lines if the finish value exceeds the maximum column width.

**Important Information and Disclaimer:**The information provided on this page represents TI's knowledge and belief as of the date that it is provided. TI bases its knowledge and belief on information provided by third parties, and makes no representation or warranty as to the accuracy of such information. Efforts are underway to better integrate information from third parties. TI has taken and continues to take reasonable steps to provide representative and accurate information but may not have conducted destructive testing or chemical analysis on incoming materials and chemicals. TI and TI suppliers consider certain information to be proprietary, and thus CAS numbers and other limited information may not be available for release.

In no event shall TI's liability arising out of such information exceed the total purchase price of the TI part(s) at issue in this document sold by TI to Customer on an annual basis.

## TAPE AND REEL INFORMATION



### QUADRANT ASSIGNMENTS FOR PIN 1 ORIENTATION IN TAPE



\*All dimensions are nominal

| Device             | Package Type | Package Drawing | Pins | SPQ  | Reel Diameter (mm) | Reel Width W1 (mm) | A0 (mm) | B0 (mm) | K0 (mm) | P1 (mm) | W (mm) | Pin1 Quadrant |
|--------------------|--------------|-----------------|------|------|--------------------|--------------------|---------|---------|---------|---------|--------|---------------|
| LM9036DTX-5.0/NOPB | TO-252       | NDP             | 3    | 2500 | 330.0              | 16.4               | 6.9     | 10.5    | 2.7     | 8.0     | 16.0   | Q2            |
| LM9036MM-3.3/NOPB  | VSSOP        | DGK             | 8    | 1000 | 178.0              | 12.4               | 5.3     | 3.4     | 1.4     | 8.0     | 12.0   | Q1            |
| LM9036MM-5.0/NOPB  | VSSOP        | DGK             | 8    | 1000 | 178.0              | 12.4               | 5.3     | 3.4     | 1.4     | 8.0     | 12.0   | Q1            |
| LM9036MX-3.3/NOPB  | SOIC         | D               | 8    | 2500 | 330.0              | 12.4               | 6.5     | 5.4     | 2.0     | 8.0     | 12.0   | Q1            |
| LM9036MX-5.0/NOPB  | SOIC         | D               | 8    | 2500 | 330.0              | 12.4               | 6.5     | 5.4     | 2.0     | 8.0     | 12.0   | Q1            |

**TAPE AND REEL BOX DIMENSIONS**

\*All dimensions are nominal

| Device             | Package Type | Package Drawing | Pins | SPQ  | Length (mm) | Width (mm) | Height (mm) |
|--------------------|--------------|-----------------|------|------|-------------|------------|-------------|
| LM9036DTX-5.0/NOPB | TO-252       | NDP             | 3    | 2500 | 367.0       | 367.0      | 38.0        |
| LM9036MM-3.3/NOPB  | VSSOP        | DGK             | 8    | 1000 | 210.0       | 185.0      | 35.0        |
| LM9036MM-5.0/NOPB  | VSSOP        | DGK             | 8    | 1000 | 210.0       | 185.0      | 35.0        |
| LM9036MX-3.3/NOPB  | SOIC         | D               | 8    | 2500 | 367.0       | 367.0      | 35.0        |
| LM9036MX-5.0/NOPB  | SOIC         | D               | 8    | 2500 | 367.0       | 367.0      | 35.0        |

NDP0003B

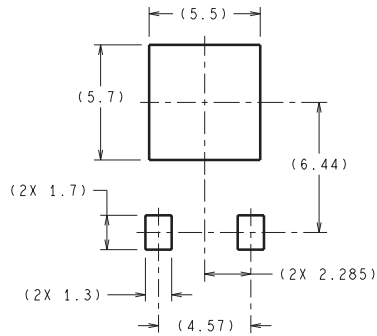

DIMENSIONS ARE IN MILLIMETERS  
DIMENSIONS IN ( ) FOR REFERENCE ONLY

LAND PATTERN RECOMMENDATION

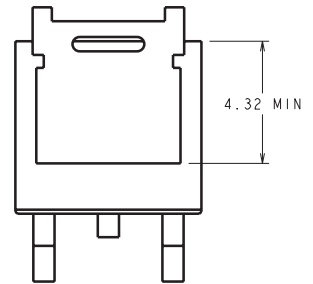
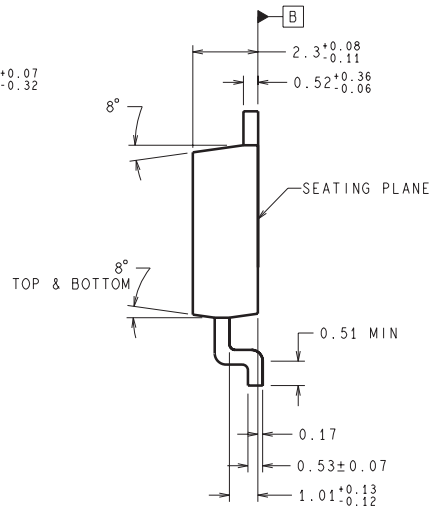
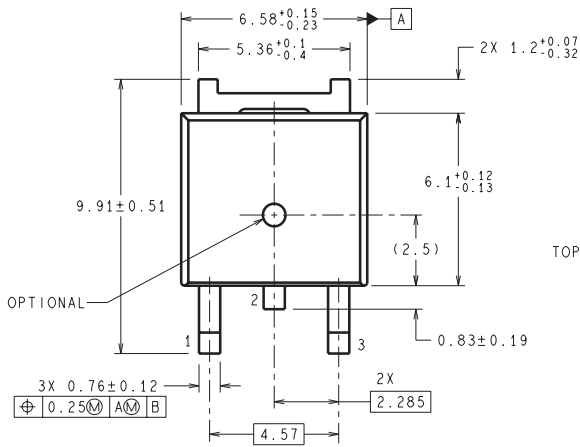

TD03B (Rev F)



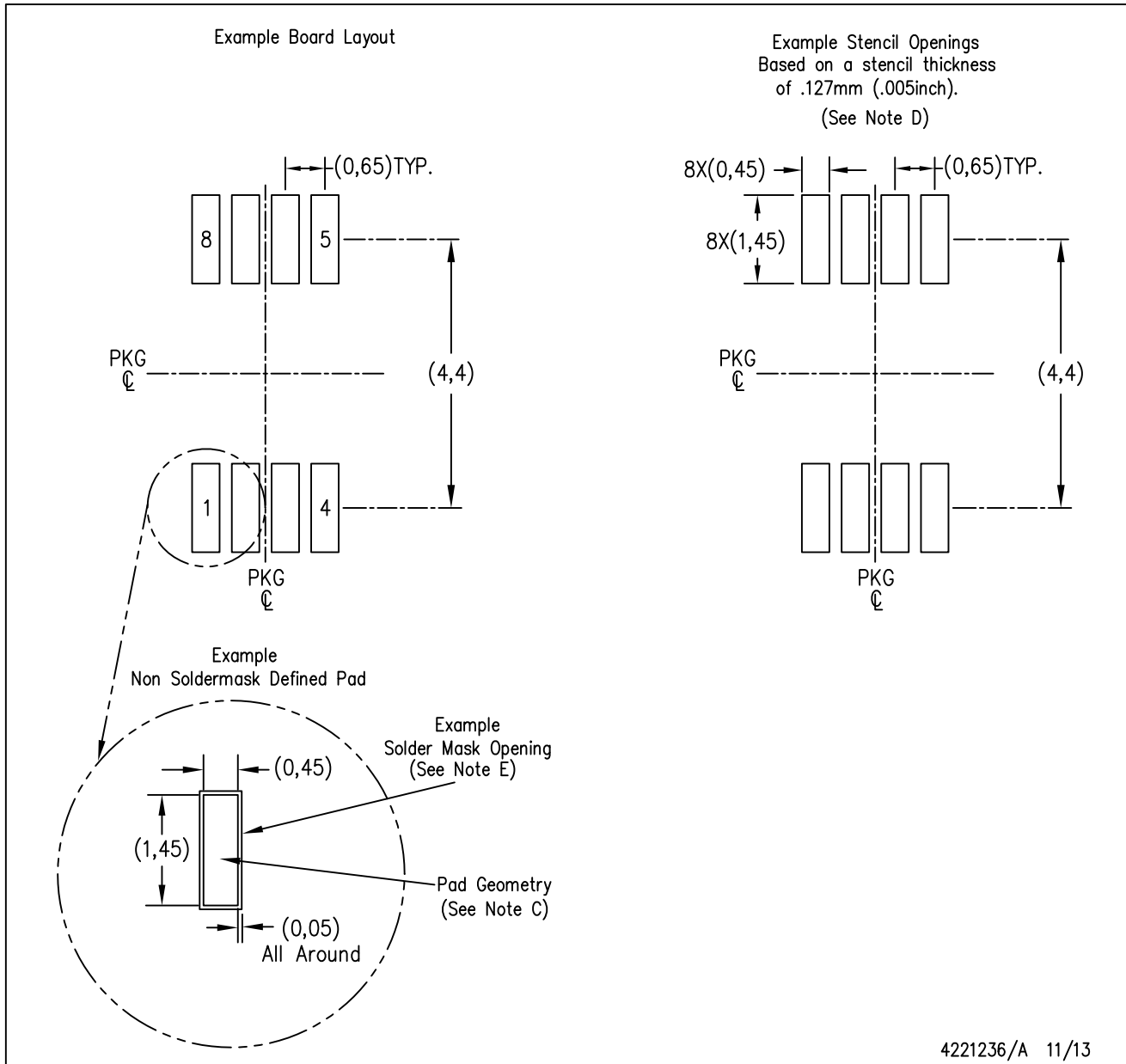

- NOTES:
- A. All linear dimensions are in millimeters.
  - B. This drawing is subject to change without notice.
  - C. Publication IPC-7351 is recommended for alternate designs.
  - D. Laser cutting apertures with trapezoidal walls and also rounding corners will offer better paste release. Customers should contact their board assembly site for stencil design recommendations. Refer to IPC-7525 for other stencil recommendations.
  - E. Customers should contact their board fabrication site for solder mask tolerances between and around signal pads.

D (R-PDSO-G8)

PLASTIC SMALL OUTLINE

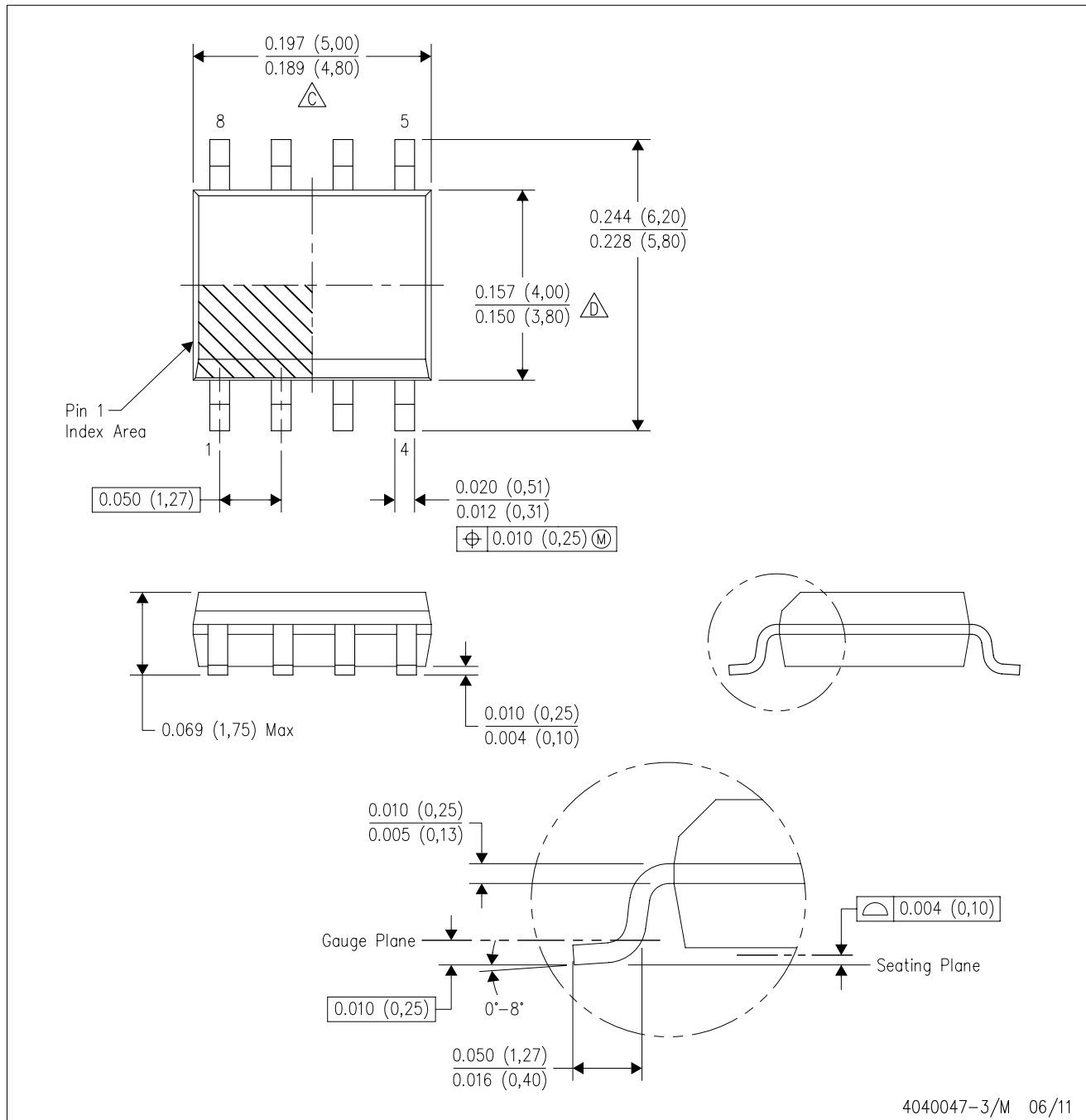

NOTES: A. All linear dimensions are in inches (millimeters).  
 B. This drawing is subject to change without notice.  
 C. Body length does not include mold flash, protrusions, or gate burrs. Mold flash, protrusions, or gate burrs shall not exceed 0.006 (0,15) each side.  
 D. Body width does not include interlead flash. Interlead flash shall not exceed 0.017 (0,43) each side.  
 E. Reference JEDEC MS-012 variation AA.

## IMPORTANT NOTICE

Texas Instruments Incorporated and its subsidiaries (TI) reserve the right to make corrections, enhancements, improvements and other changes to its semiconductor products and services per JESD46, latest issue, and to discontinue any product or service per JESD48, latest issue. Buyers should obtain the latest relevant information before placing orders and should verify that such information is current and complete. All semiconductor products (also referred to herein as "components") are sold subject to TI's terms and conditions of sale supplied at the time of order acknowledgment.

TI warrants performance of its components to the specifications applicable at the time of sale, in accordance with the warranty in TI's terms and conditions of sale of semiconductor products. Testing and other quality control techniques are used to the extent TI deems necessary to support this warranty. Except where mandated by applicable law, testing of all parameters of each component is not necessarily performed.

TI assumes no liability for applications assistance or the design of Buyers' products. Buyers are responsible for their products and applications using TI components. To minimize the risks associated with Buyers' products and applications, Buyers should provide adequate design and operating safeguards.

TI does not warrant or represent that any license, either express or implied, is granted under any patent right, copyright, mask work right, or other intellectual property right relating to any combination, machine, or process in which TI components or services are used. Information published by TI regarding third-party products or services does not constitute a license to use such products or services or a warranty or endorsement thereof. Use of such information may require a license from a third party under the patents or other intellectual property of the third party, or a license from TI under the patents or other intellectual property of TI.

Reproduction of significant portions of TI information in TI data books or data sheets is permissible only if reproduction is without alteration and is accompanied by all associated warranties, conditions, limitations, and notices. TI is not responsible or liable for such altered documentation. Information of third parties may be subject to additional restrictions.

Resale of TI components or services with statements different from or beyond the parameters stated by TI for that component or service voids all express and any implied warranties for the associated TI component or service and is an unfair and deceptive business practice. TI is not responsible or liable for any such statements.

Buyer acknowledges and agrees that it is solely responsible for compliance with all legal, regulatory and safety-related requirements concerning its products, and any use of TI components in its applications, notwithstanding any applications-related information or support that may be provided by TI. Buyer represents and agrees that it has all the necessary expertise to create and implement safeguards which anticipate dangerous consequences of failures, monitor failures and their consequences, lessen the likelihood of failures that might cause harm and take appropriate remedial actions. Buyer will fully indemnify TI and its representatives against any damages arising out of the use of any TI components in safety-critical applications.

In some cases, TI components may be promoted specifically to facilitate safety-related applications. With such components, TI's goal is to help enable customers to design and create their own end-product solutions that meet applicable functional safety standards and requirements. Nonetheless, such components are subject to these terms.

No TI components are authorized for use in FDA Class III (or similar life-critical medical equipment) unless authorized officers of the parties have executed a special agreement specifically governing such use.

Only those TI components which TI has specifically designated as military grade or "enhanced plastic" are designed and intended for use in military/aerospace applications or environments. Buyer acknowledges and agrees that any military or aerospace use of TI components which have **not** been so designated is solely at the Buyer's risk, and that Buyer is solely responsible for compliance with all legal and regulatory requirements in connection with such use.

TI has specifically designated certain components as meeting ISO/TS16949 requirements, mainly for automotive use. In any case of use of non-designated products, TI will not be responsible for any failure to meet ISO/TS16949.

### Products

|                              |  |
|------------------------------|--|
| Audio                        | <a href="http://www.ti.com/audio">www.ti.com/audio</a>                               |
| Amplifiers                   | <a href="http://amplifier.ti.com">amplifier.ti.com</a>                               |
| Data Converters              | <a href="http://dataconverter.ti.com">dataconverter.ti.com</a>                       |
| DLP® Products                | <a href="http://www.dlp.com">www.dlp.com</a>   |
| DSP                          | <a href="http://dsp.ti.com">dsp.ti.com</a>   |
| Clocks and Timers            | <a href="http://www.ti.com/clocks">www.ti.com/clocks</a>                             |
| Interface                    | <a href="http://interface.ti.com">interface.ti.com</a>                               |
| Logic                        | <a href="http://logic.ti.com">logic.ti.com</a>                                       |
| Power Mgmt                   | <a href="http://power.ti.com">power.ti.com</a>                                       |
| Microcontrollers             | <a href="http://microcontroller.ti.com">microcontroller.ti.com</a>                   |
| RFID                         | <a href="http://www.ti-rfid.com">www.ti-rfid.com</a>                                 |
| OMAP Applications Processors | <a href="http://www.ti.com/omap">www.ti.com/omap</a>                                 |
| Wireless Connectivity        | <a href="http://www.ti.com/wirelessconnectivity">www.ti.com/wirelessconnectivity</a> |

### Applications

|                               |  |
|-------------------------------|--|
| Automotive and Transportation | <a href="http://www.ti.com/automotive">www.ti.com/automotive</a>                         |
| Communications and Telecom    | <a href="http://www.ti.com/communications">www.ti.com/communications</a>                 |
| Computers and Peripherals     | <a href="http://www.ti.com/computers">www.ti.com/computers</a>                           |
| Consumer Electronics          | <a href="http://www.ti.com/consumer-apps">www.ti.com/consumer-apps</a>                   |
| Energy and Lighting           | <a href="http://www.ti.com/energy">www.ti.com/energy</a>                                 |
| Industrial                    | <a href="http://www.ti.com/industrial">www.ti.com/industrial</a>                         |
| Medical                       | <a href="http://www.ti.com/medical">www.ti.com/medical</a>                               |
| Security                      | <a href="http://www.ti.com/security">www.ti.com/security</a>                             |
| Space, Avionics and Defense   | <a href="http://www.ti.com/space-avionics-defense">www.ti.com/space-avionics-defense</a> |
| Video and Imaging             | <a href="http://www.ti.com/video">www.ti.com/video</a>                                   |

### TI E2E Community

[e2e.ti.com](http://e2e.ti.com)