

LMH6628 Dual Wideband, Low Noise, Voltage Feedback Op Amp

Check for Samples: [LMH6628](#)

FEATURES

- **Wide Unity Gain Bandwidth: 300MHz**
- **Low Noise: $2\text{nV}/\sqrt{\text{Hz}}$**
- **Low Distortion: $-65/-74\text{dBc}$ (10MHz)**
- **Settling Time: 12ns to 0.1%**
- **Wide Supply Voltage Range: $\pm 2.5\text{V}$ to $\pm 6\text{V}$**
- **High Output Current: $\pm 85\text{mA}$**
- **Improved Replacement for CLC428**

APPLICATIONS

- **High Speed Dual Op Amp**
- **Low Noise Integrators**
- **Low Noise Active Filters**
- **Driver/receiver for Transmission Systems**
- **High Speed Detectors**
- **I/Q Channel Amplifiers**

DESCRIPTION

The Texas Instruments LMH6628 is a high speed dual op amp that offers a traditional voltage feedback topology featuring unity gain stability and slew enhanced circuitry. The LMH6628's low noise and very low harmonic distortion combine to form a wide dynamic range op amp that operates from a single (5V to 12V) or dual ($\pm 5\text{V}$) power supply.

Each of the LMH6628's closely matched channels provides a 300MHz unity gain bandwidth and low input voltage noise density ($2\text{nV}/\sqrt{\text{Hz}}$). Low 2nd/3rd harmonic distortion ($-65/-74\text{dBc}$ at 10MHz) make the LMH6628 a perfect wide dynamic range amplifier for matched I/Q channels.

With its fast and accurate settling (12ns to 0.1%), the LMH6628 is also an excellent choice for wide dynamic range, anti-aliasing filters to buffer the inputs of hi resolution analog-to-digital converters. Combining the LMH6628's two tightly matched amplifiers in a single 8-pin SOIC package reduces cost and board space for many composite amplifier applications such as active filters, differential line drivers/receivers, fast peak detectors and instrumentation amplifiers.

The LMH6628 is fabricated using TI's VIP10™ complimentary bipolar process.

To reduce design times and assist in board layout, the LMH6628 is supported by an evaluation board (CLC730036).

Connection Diagram

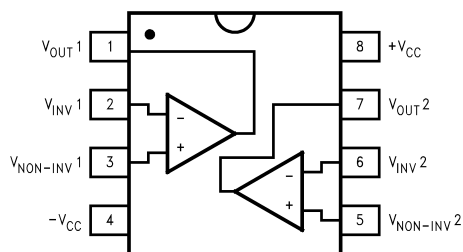

Figure 1. 8-Pin SOIC, Top View



Please be aware that an important notice concerning availability, standard warranty, and use in critical applications of Texas Instruments semiconductor products and disclaimers thereto appears at the end of this data sheet.

VIP10 is a trademark of Texas Instruments.

All other trademarks are the property of their respective owners.

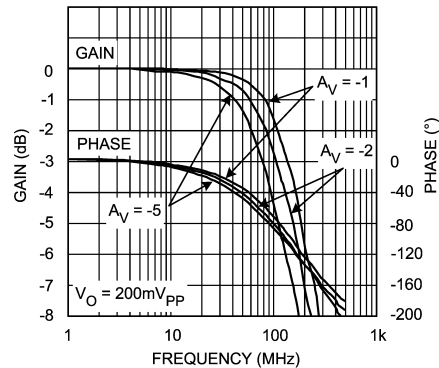

Figure 2. Inverting Frequency Response



These devices have limited built-in ESD protection. The leads should be shorted together or the device placed in conductive foam during storage or handling to prevent electrostatic damage to the MOS gates.

Absolute Maximum Ratings⁽¹⁾⁽²⁾

| | | |
|-------------------------------------|------------------|--------------------|
| ESD Tolerance ⁽³⁾ | Human Body Model | 2kV |
| | Machine Model | 200V |
| Supply Voltage | | 13.5 |
| Short Circuit Current | | See ⁽⁴⁾ |
| Common-Mode Input Voltage | | $V^+ - V^-$ |
| Differential Input Voltage | | $V^+ - V^-$ |
| Maximum Junction Temperature | | +150°C |
| Storage Temperature Range | | -65°C to +150°C |
| Lead Temperature (soldering 10 sec) | | +300°C |

- (1) Absolute Maximum Ratings indicate limits beyond which damage to the device may occur. Operating Ratings indicate conditions for which the device is intended to be functional, but specific performance is not ensured. For ensured specifications, see the Electrical Characteristics tables.
- (2) If Military/Aerospace specified devices are required, please contact the Texas Instruments Sales Office/ Distributors for availability and specifications.
- (3) Human body model, 1.5k Ω in series with 100pF. Machine model, 0 Ω in series with 200pF.
- (4) Output is short circuit protected to ground, however maximum reliability is obtained if output current does not exceed 160mA.

Operating Ratings⁽¹⁾

| | | |
|-----------------------------------|------------------------|-------------------|
| Thermal Resistance ⁽²⁾ | | |
| Package | (θ_{JC}) | (θ_{JA}) |
| SOIC | 65°C/W | 145°C/W |
| Temperature Range | -40°C to +85°C | |
| Nominal Supply Voltage | $\pm 2.5V$ to $\pm 6V$ | |

- (1) Absolute Maximum Ratings indicate limits beyond which damage to the device may occur. Operating Ratings indicate conditions for which the device is intended to be functional, but specific performance is not ensured. For ensured specifications, see the Electrical Characteristics tables.
- (2) The maximum power dissipation is a function of $T_{J(MAX)}$, θ_{JA} and T_A . The maximum allowable power dissipation at any ambient temperature is $P_D = (T_{J(MAX)} - T_A) / \theta_{JA}$. All numbers apply for packages soldered directly onto a PC board.

Electrical Characteristics⁽¹⁾

$V_{CC} = \pm 5V$, $A_V = +2V/V$, $R_F = 100\Omega$, $R_G = 100\Omega$, $R_L = 100\Omega$; unless otherwise specified. **Boldface** limits apply at the temperature extremes.

| Symbol | Parameter | Conditions | Min | Typ | Max | Units |
|--------------------------------------|--------------------------------|-----------------------------|-------------------|----------------|--|-----------------------|
| Frequency Domain Response | | | | | | |
| GB | Gain Bandwidth Product | $V_O < 0.5V_{PP}$ | | 200 | | MHz |
| SSBW | -3dB Bandwidth, $A_V = +1$ | $V_O < 0.5V_{PP}$ | 180 | 300 | | MHz |
| SSBW | -3dB Bandwidth, $A_V = +2$ | $V_O < 0.5V_{PP}$ | | 100 | | MHz |
| GFL | Gain Flatness | $V_O < 0.5V_{PP}$ | | | | |
| GFP | Peaking | DC to 200MHz | | 0.0 | | dB |
| GFR | Rolloff | DC to 20MHz | | .1 | | dB |
| LPD | Linear Phase Deviation | DC to 20MHz | | .1 | | deg |
| Time Domain Response | | | | | | |
| TR | Rise and Fall Time | 1V Step | | 4 | | ns |
| TS | Settling Time | 2V Step to 0.1% | | 12 | | ns |
| OS | Overshoot | 1V Step | | 1 | | % |
| SR | Slew Rate | 4V Step | 300 | 550 | | V/ μ s |
| Distortion And Noise Response | | | | | | |
| HD2 | 2nd Harmonic Distortion | 1V _{PP} , 10MHz | | -65 | | dBc |
| HD3 | 3rd Harmonic Distortion | 1V _{PP} , 10MHz | | -74 | | dBc |
| V_N | Equivalent Input Noise Voltage | 1MHz to 100MHz | | 2 | | nV/ \sqrt{Hz} |
| | | I_N | Current | 1MHz to 100MHz | | 2 |
| XTLKA | Crosstalk | Input Referred, 10MHz | | -62 | | dB |
| Static, DC Performance | | | | | | |
| G_{OL} | Open-Loop Gain | | 56 53 | 63 | | dB |
| V_{IO} | Input Offset Voltage | | | ± 5 | ± 2 ± 2.6 | mV |
| DV_{IO} | Average Drift | | | 5 | | μ V/ $^{\circ}$ C |
| I_{BN} | Input Bias Current | | | ± 7 | ± 20 ± 30 | μ A |
| DI_{BN} | Average Drift | | | 150 | | nA/ $^{\circ}$ C |
| I_{OS} | Input Offset Current | | | 0.3 | ± 6 | μ A |
| I_{OSD} | Average Drift | | | 5 | | nA/ $^{\circ}$ C |
| PSRR | Power Supply Rejection Ratio | | 60 46 | 70 | | dB |
| CMRR | Common-Mode Rejection Ratio | | 57 54 | 62 | | dB |
| I_{CC} | Supply Current | Per Channel, $R_L = \infty$ | 7.5 7.0 | 9 | 12 12.5 | mA |
| Miscellaneous Performance | | | | | | |
| R_{IN} | Input Resistance | Common-Mode | | 500 | | k Ω |
| | | Differential-Mode | | 200 | | k Ω |
| C_{IN} | Input Capacitance | Common-Mode | | 1.5 | | pF |
| | | Differential-Mode | | 1.5 | | pF |
| R_{OUT} | Output Resistance | Closed-Loop | | .1 | | Ω |

(1) Electrical Table values apply only for factory testing conditions at the temperature indicated. Factory testing conditions result in very limited self-heating of the device such that $T_J = T_A$. No specification of parametric performance is indicated in the electrical tables under conditions of internal self heating where $T_J > T_A$. See Note 6 for information on temperature de-rating of this device." Min/Max ratings are based on product characterization and simulation. Individual parameters are tested as noted.

Electrical Characteristics⁽¹⁾ (continued)

$V_{CC} = \pm 5V$, $A_V = +2V/V$, $R_F = 100\Omega$, $R_G = 100\Omega$, $R_L = 100\Omega$; unless otherwise specified. **Boldface** limits apply at the temperature extremes.

| Symbol | Parameter | Conditions | Min | Typ | Max | Units |
|----------|----------------------|-------------------|--|-----------|-----|-------|
| V_O | Output Voltage Range | $R_L = \infty$ | | ± 3.8 | | V |
| V_{OL} | | $R_L = 100\Omega$ | ± 3.2 ± 3.1 | ± 3.5 | | V |
| CMIR | Input Voltage Range | Common- Mode | | ± 3.7 | | V |
| I_O | Output Current | | ± 50 | ± 85 | | mA |

Typical Performance Characteristics

($T_A = +25^\circ$, $A_V = +2$, $V_{CC} = \pm 5V$, $R_f = 100\Omega$, $R_L = 100\Omega$, unless specified)

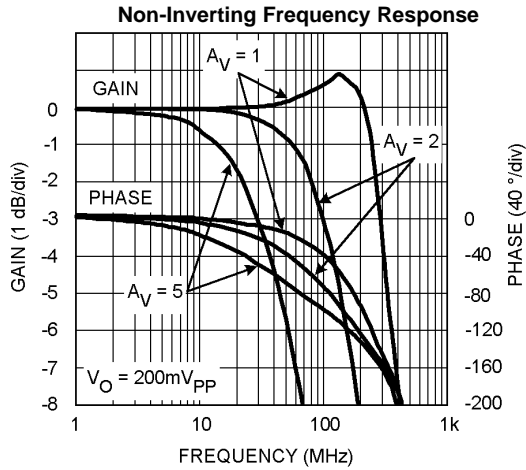

Figure 3.

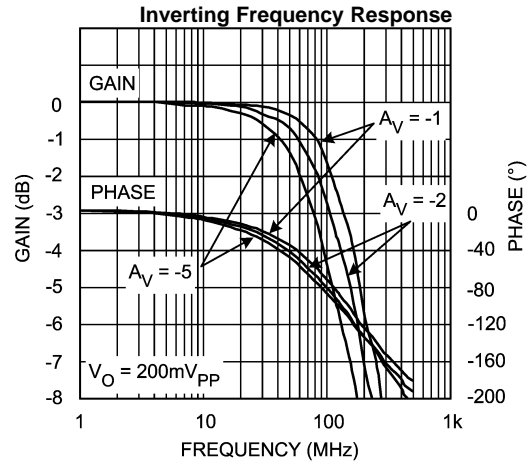

Figure 4.

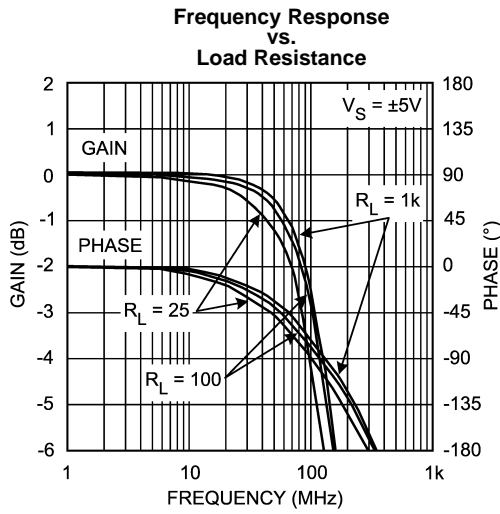

Figure 5.

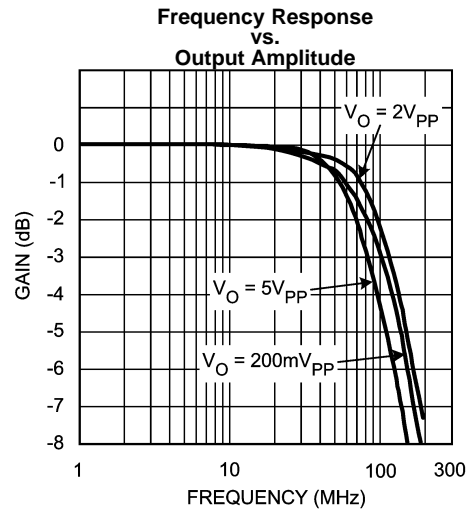

Figure 6.

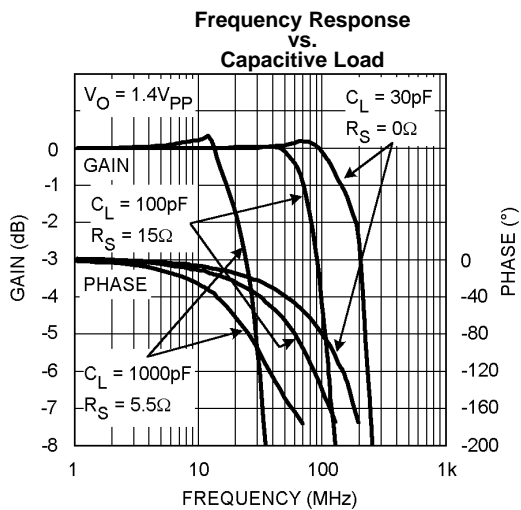

Figure 7.

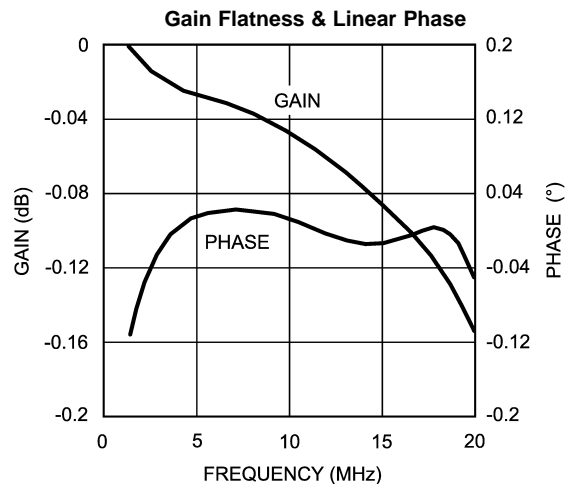

Figure 8.

Typical Performance Characteristics (continued)

($T_A = +25^\circ$, $A_V = +2$, $V_{CC} = \pm 5V$, $R_f = 100\Omega$, $R_L = 100\Omega$, unless specified)

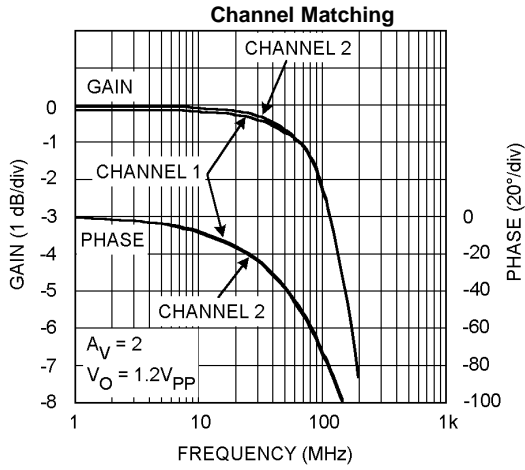

Figure 9.

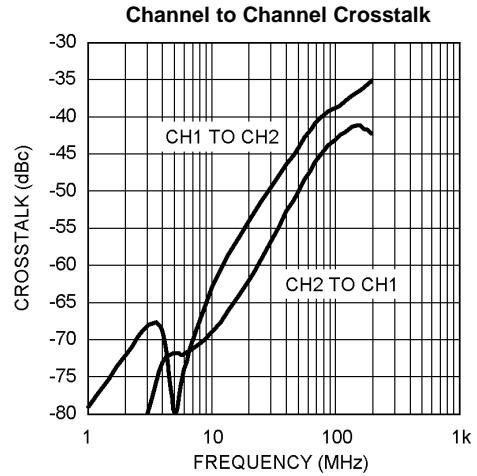

Figure 10.

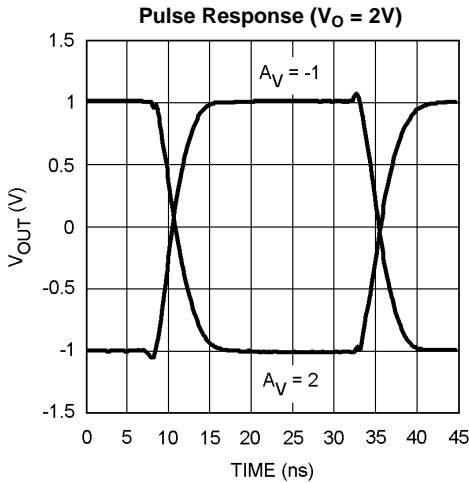

Figure 11.

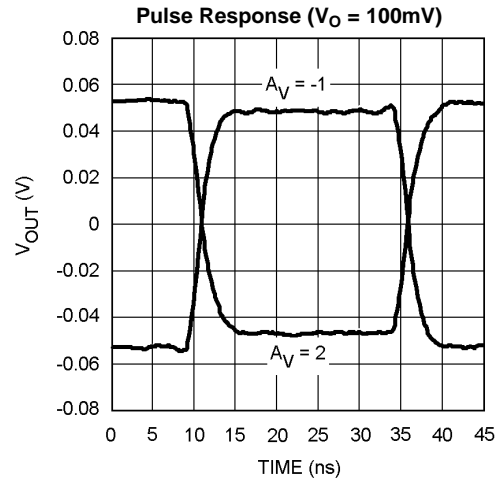

Figure 12.

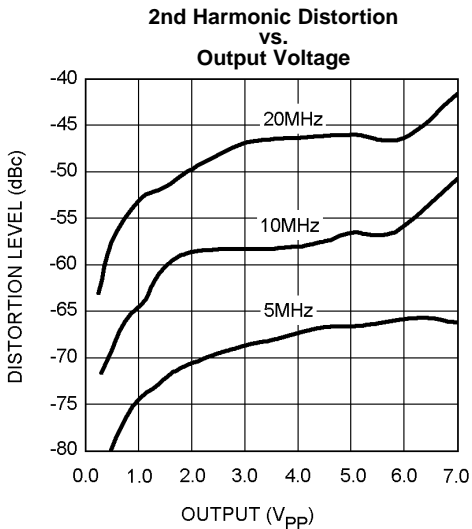

Figure 13.

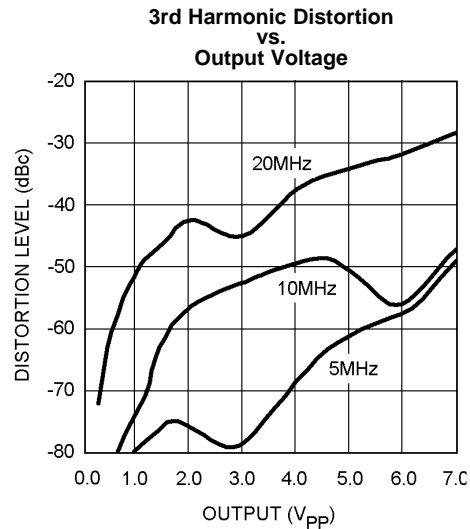

Figure 14.

Typical Performance Characteristics (continued)

($T_A = +25^\circ$, $A_V = +2$, $V_{CC} = \pm 5V$, $R_F = 100\Omega$, $R_L = 100\Omega$, unless specified)

2nd & 3rd Harmonic Distortion vs. Frequency

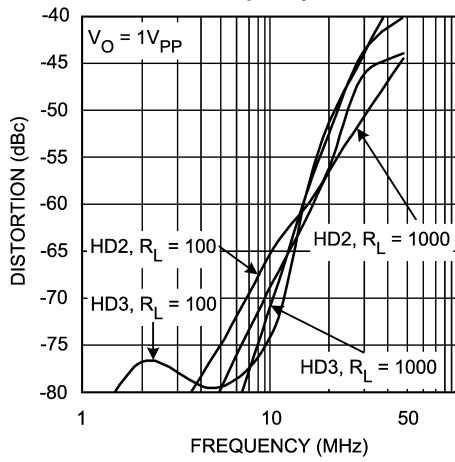

Figure 15.

PSRR and CMRR ($\pm 5V$)

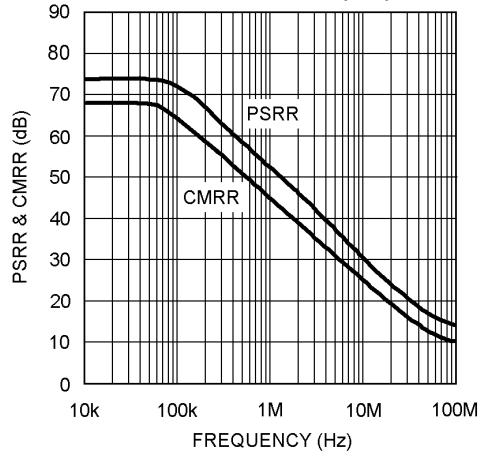

Figure 16.

PSRR and CMRR ($\pm 2.5V$)

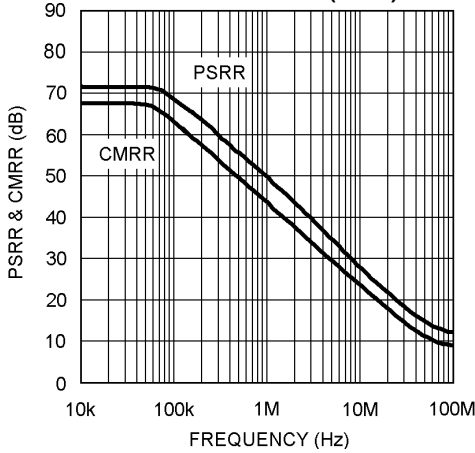

Figure 17.

Closed Loop Output Resistance ($\pm 2.5V$)

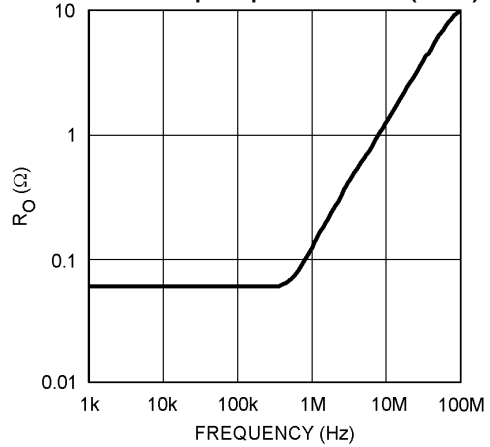

Figure 18.

Closed Loop Output Resistance ($\pm 5V$)

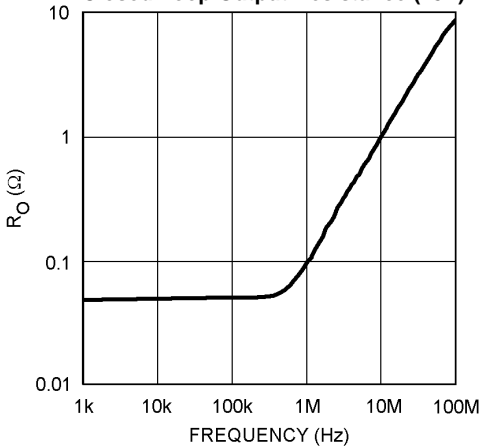

Figure 19.

Open Loop Gain & Phase ($\pm 2.5V$)

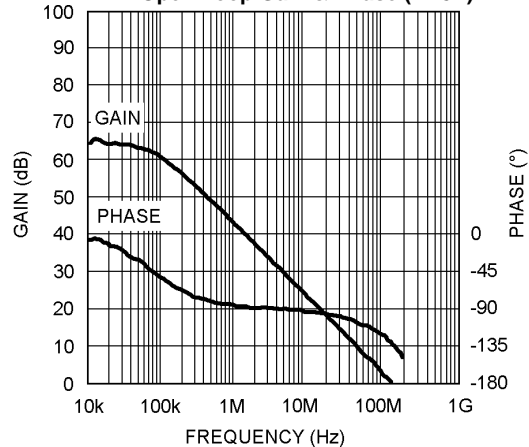

Figure 20.

Typical Performance Characteristics (continued)

($T_A = +25^\circ$, $A_V = +2$, $V_{CC} = \pm 5V$, $R_f = 100\Omega$, $R_L = 100\Omega$, unless specified)

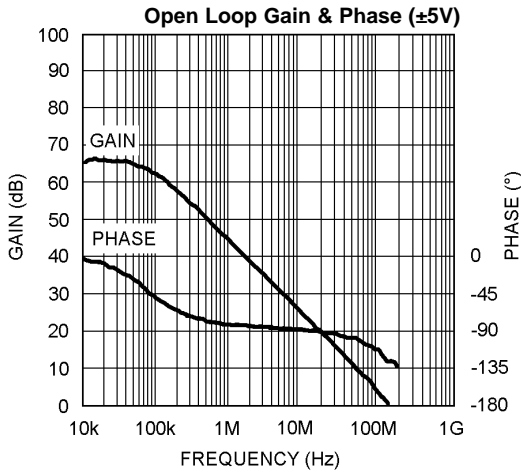

Figure 21.

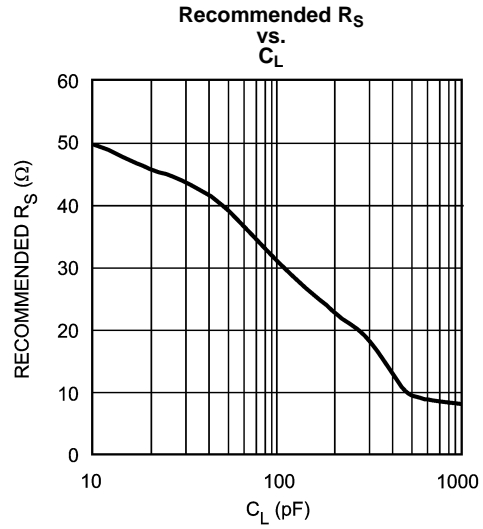

Figure 22.

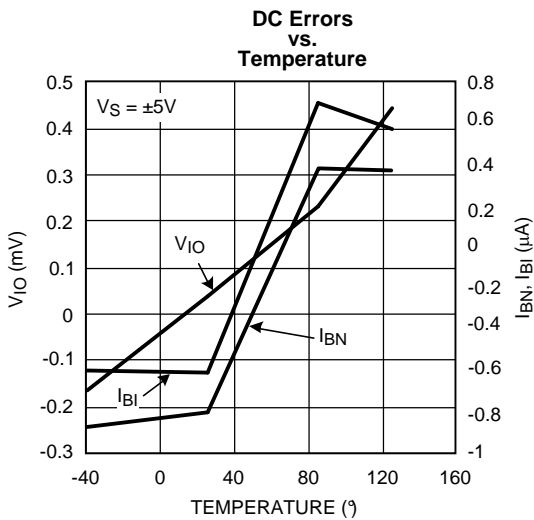

Figure 23.

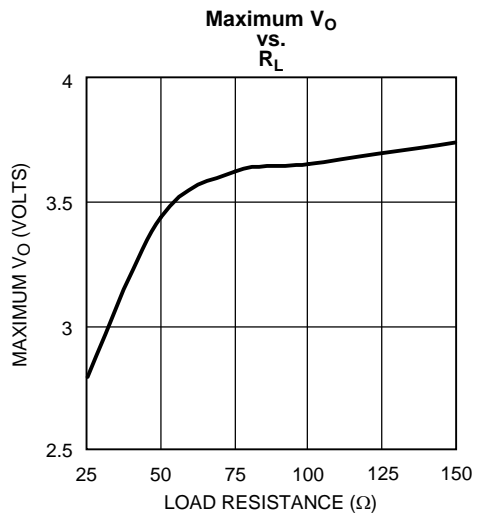

Figure 24.

Typical Performance Characteristics (continued)

($T_A = +25^\circ$, $A_V = +2$, $V_{CC} = \pm 5V$, $R_f = 100\Omega$, $R_L = 100\Omega$, unless specified)

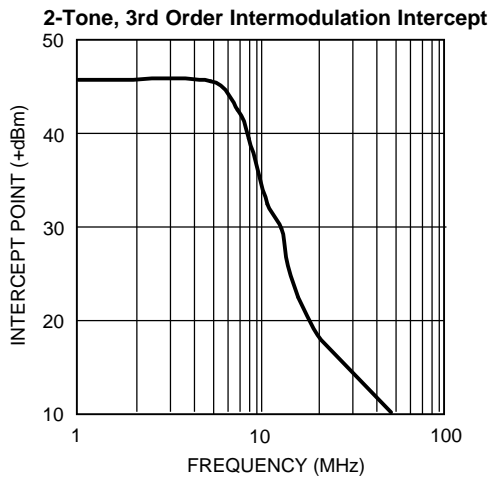

Figure 25.

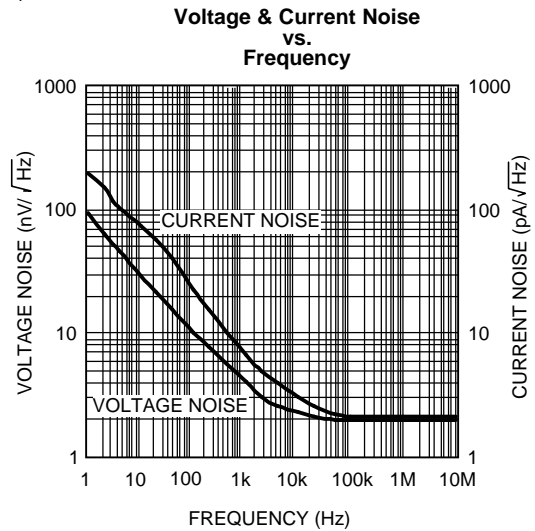

Figure 26.

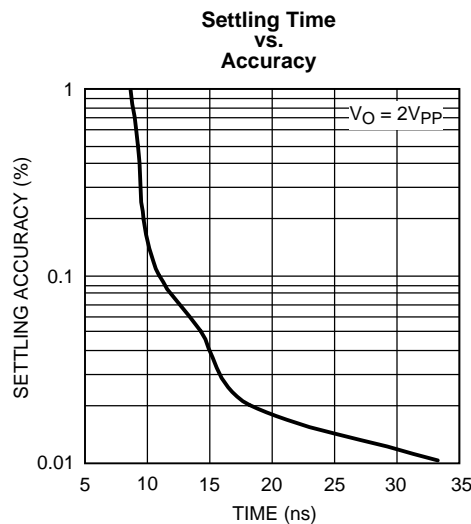

Figure 27.

APPLICATION SECTION

LOW NOISE DESIGN

Ultimate low noise performance from circuit designs using the LMH6628 requires the proper selection of external resistors. By selecting appropriate low valued resistors for R_F and R_G , amplifier circuits using the LMH6628 can achieve output noise that is approximately the equivalent voltage input noise of $2nV/\sqrt{Hz}$ multiplied by the desired gain (A_V).

DC BIAS CURRENTS AND OFFSET VOLTAGES

Cancellation of the output offset voltage due to input bias currents is possible with the LMH6628. This is done by making the resistance seen from the inverting and non-inverting inputs equal. Once done, the residual output offset voltage will be the input offset voltage (V_{OS}) multiplied by the desired gain (A_V). Application Note OA-7 (SNOA365) offers several solutions to further reduce the output offset.

OUTPUT AND SUPPLY CONSIDERATIONS

With $\pm 5V$ supplies, the LMH6628 is capable of a typical output swing of $\pm 3.8V$ under a no-load condition. Additional output swing is possible with slightly higher supply voltages. For loads of less than 50Ω , the output swing will be limited by the LMH6628's output current capability, typically 85mA.

Output settling time when driving capacitive loads can be improved by the use of a series output resistor. See Figure 22.

LAYOUT

Proper power supply bypassing is critical to insure good high frequency performance and low noise. De-coupling capacitors of $0.1\mu F$ should be placed as close as possible to the power supply pins. The use of surface mounted capacitors is recommended due to their low series inductance.

A good high frequency layout will keep power supply and ground traces away from the inverting input and output pins. Parasitic capacitance from these nodes to ground causes frequency response peaking and possible circuit oscillation. See OA-15 (SNOA367) for more information. Texas Instruments suggests the CLC730036 (SOIC) dual op amp evaluation board as a guide for high frequency layout and as an aid in device evaluation.

ANALOG DELAY CIRCUIT (ALL-PASS NETWORK)

The circuit in Figure 28 implements an all-pass network using the LMH6628. A wide bandwidth buffer (LM7121) drives the circuit and provides a high input impedance for the source. As shown in Figure 29, the circuit provides a 13.1ns delay (with $R = 40.2\Omega$, $C = 47pF$). R_F and R_G should be of equal and low value for parasitic insensitive operation.

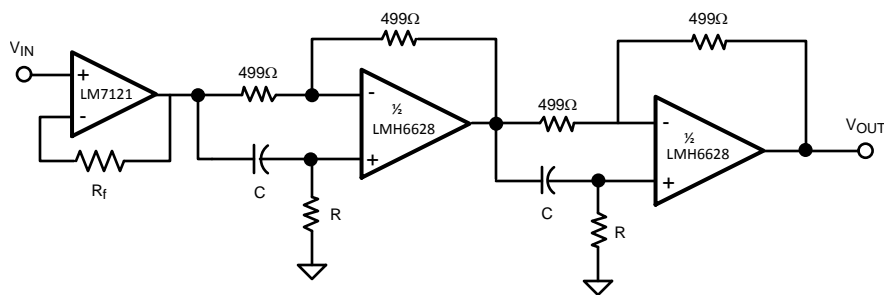

Figure 28. Circuit That Implements an All-pass Network Using the LMH6628

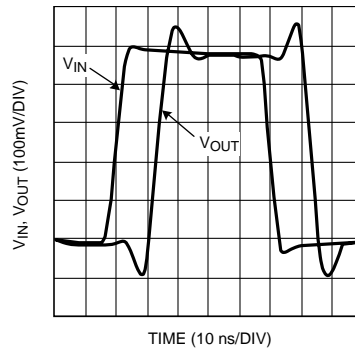

Figure 29. Delay Circuit Response to 0.5V Pulse

The circuit gain is +1 and the delay is determined by the following equations.

$$\tau_{\text{delay}} = 2(2RC + T_d) \tag{1}$$

$$T_d = \frac{1}{360} \frac{d\phi}{df}; \tag{2}$$

where T_d is the delay of the op amp at $A_V = +1$.

The LMH6628 provides a typical delay of 2.8ns at its -3dB point.

FULL DUPLEX DIGITAL OR ANALOG TRANSMISSION

Simultaneous transmission and reception of analog or digital signals over a single coaxial cable or twisted-pair line can reduce cabling requirements. The LMH6628's wide bandwidth and high common-mode rejection in a differential amplifier configuration allows full duplex transmission of video, telephone, control and audio signals.

In the circuit shown in Figure 30, one of the LMH6628's amps is used as a "driver" and the other as a difference "receiver" amplifier. The output impedance of the "driver" is essentially zero. The two R's are chosen to match the characteristic impedance of the transmission line. The "driver" op amp gain can be selected for unity or greater.

Receiver amplifier A_2 (B_2) is connected across R and forms differential amplifier for the signals transmitted by driver A_2 (B_2). If R_F equals R_G , receiver A_2 (B_1) will then reject the signals from driver A_1 (B_1) and pass the signals from driver B_1 (A_1).

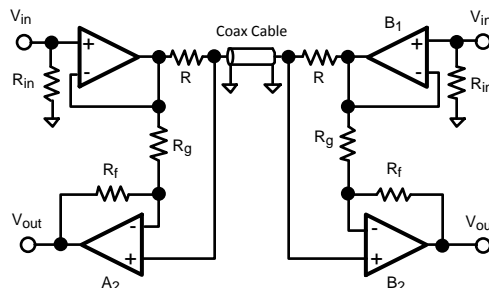

Figure 30. Full Duplex Transmit and Receive Using the LMH6628

The output of the receiver amplifier will be:

$$V_{\text{out}_{A(B)}} = \frac{1}{2} V_{\text{in}_{A(B)}} \left[1 - \frac{R_f}{R_g} \right] + \frac{1}{2} V_{\text{in}_{B(A)}} \left[1 + \frac{R_f}{R_g} \right] \tag{3}$$

Care must be given to layout and component placement to maintain a high frequency common-mode rejection. The plot of Figure 31 shows the simultaneous reception of signals transmitted at 1MHz and 10MHz.

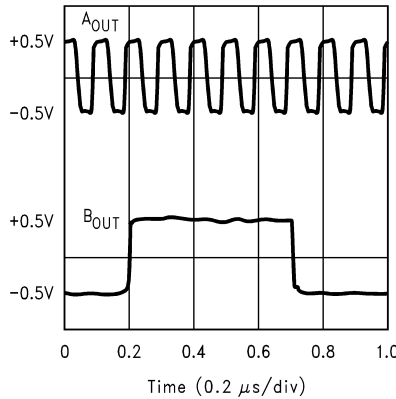

Figure 31. Simultaneous Reception of Signals Transmitted at 1MHz and 10MHz

POSITIVE PEAK DETECTOR

The LMH6628's dual amplifiers can be used to implement a unity-gain peak detector circuit as shown in Figure 32.

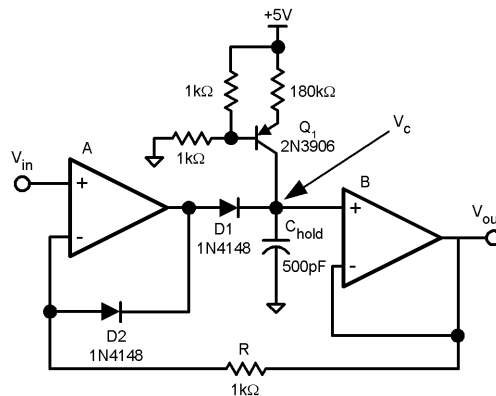

Figure 32. LMH6628's Dual Amplifiers Used to Implement a Unity-Gain Peak Detector Circuit

The acquisition speed of this circuit is limited by the dynamic resistance of the diode when charging C_{hold}. A plot of the circuit's performance is shown in Figure 33 with a 1MHz sinusoidal input.

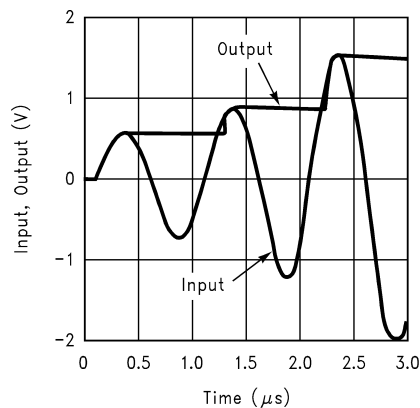

Figure 33. Circuit's Performance With a 1MHz Sinusoidal Input

A current source, built around Q1, provides the necessary bias current for the second amplifier and prevents saturation when power is applied. The resistor, R, closes the loop while diode D2 prevents negative saturation when V_{IN} is less than V_C . A MOS-type switch (not shown) can be used to reset the capacitor's voltage.

The maximum speed of detection is limited by the delay of the op amps and the diodes. The use of Schottky diodes will provide faster response.

ADJUSTABLE OR BANDPASS EQUALIZER

A "boost" equalizer can be made with the LMH6628 by summing a bandpass response with the input signal, as shown in [Figure 34](#).

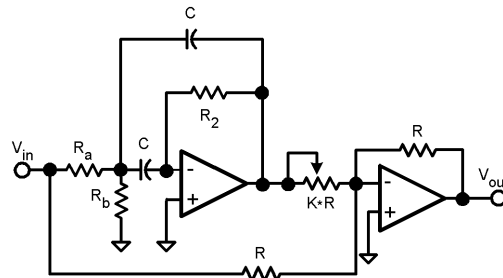

Figure 34. "Boost" Equalizer Made With the LMH6628 by Summing a Bandpass Response With the Input Signal

The overall transfer function is shown in [Equation 4](#).

$$\frac{V_{out}}{V_{in}} = \left[\frac{R_b}{K(R_a + R_b)} \right] \frac{s2Q\omega_o}{s^2 + s \frac{\omega_o}{Q} + \omega_o^2} - 1 \quad (4)$$

To build a boost circuit, use the design equations [Equation 5](#) and [Equation 6](#).

$$\frac{R_2 C}{2} = \frac{Q}{\omega_o} \quad (5)$$

$$2C (R_a || R_b) = \frac{1}{Q\omega_o} \quad (6)$$

Select R_2 and C using [Equation 5](#). Use reasonable values for high frequency circuits - R_2 between 10Ω and $5k\Omega$, C between $10pF$ and $2000pF$. Use [Equation 6](#) to determine the parallel combination of R_a and R_b . Select R_a and R_b by either the 10Ω to $5k\Omega$ criteria or by other requirements based on the impedance V_{in} is capable of driving. Finish the design by determining the value of K from [Equation 7](#).

$$\text{Peak Gain} = \frac{V_{out}}{V_{in}} (\omega_o) = \frac{R_2}{2KR_a} - 1 \quad (7)$$

[Figure 35](#) shows an example of the response of the circuit of [Figure 34](#), where f_o is $2.3MHz$. The component values are as follows: $R_a=2.1k\Omega$, $R_b = 68.5\Omega$, $R_2 = 4.22k\Omega$, $R = 500\Omega$, $KR = 50\Omega$, $C = 120pF$.

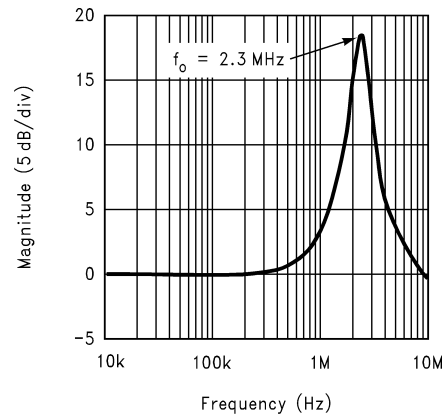

Figure 35. Example of Response of Circuit of [Figure 34](#), Where f_o is 2.3MHz

REVISION HISTORY

| Changes from Revision C (March 2013) to Revision D | Page |
|--|--------------------|
| • Changed layout of National Data Sheet to TI format | 14 |

PACKAGING INFORMATION

| Orderable Device | Status (1) | Package Type | Package Drawing | Pins | Package Qty | Eco Plan (2) | Lead/Ball Finish (6) | MSL Peak Temp (3) | Op Temp (°C) | Device Marking (4/5) | Samples |
|------------------|---------------|--------------|--------------------|------|----------------|----------------------------|-------------------------|----------------------|--------------|-------------------------|----------------|
| LMH6628MA | NRND | SOIC | D | 8 | 95 | TBD | Call TI | Call TI | -40 to 85 | | |
| LMH6628MA/NOPB | ACTIVE | SOIC | D | 8 | 95 | Green (RoHS & no Sb/Br) | CU SN | Level-1-260C-UNLIM | -40 to 85 | LMH66 28MA | Samples |
| LMH6628MAX/NOPB | ACTIVE | SOIC | D | 8 | 2500 | Green (RoHS & no Sb/Br) | CU SN | Level-1-260C-UNLIM | -40 to 85 | LMH66 28MA | Samples |

(1) The marketing status values are defined as follows:

ACTIVE: Product device recommended for new designs.

LIFEBUY: TI has announced that the device will be discontinued, and a lifetime-buy period is in effect.

NRND: Not recommended for new designs. Device is in production to support existing customers, but TI does not recommend using this part in a new design.

PREVIEW: Device has been announced but is not in production. Samples may or may not be available.

OBSOLETE: TI has discontinued the production of the device.

(2) Eco Plan - The planned eco-friendly classification: Pb-Free (RoHS), Pb-Free (RoHS Exempt), or Green (RoHS & no Sb/Br) - please check <http://www.ti.com/productcontent> for the latest availability information and additional product content details.

TBD: The Pb-Free/Green conversion plan has not been defined.

Pb-Free (RoHS): TI's terms "Lead-Free" or "Pb-Free" mean semiconductor products that are compatible with the current RoHS requirements for all 6 substances, including the requirement that lead not exceed 0.1% by weight in homogeneous materials. Where designed to be soldered at high temperatures, TI Pb-Free products are suitable for use in specified lead-free processes.

Pb-Free (RoHS Exempt): This component has a RoHS exemption for either 1) lead-based flip-chip solder bumps used between the die and package, or 2) lead-based die adhesive used between the die and leadframe. The component is otherwise considered Pb-Free (RoHS compatible) as defined above.

Green (RoHS & no Sb/Br): TI defines "Green" to mean Pb-Free (RoHS compatible), and free of Bromine (Br) and Antimony (Sb) based flame retardants (Br or Sb do not exceed 0.1% by weight in homogeneous material)

(3) MSL, Peak Temp. - The Moisture Sensitivity Level rating according to the JEDEC industry standard classifications, and peak solder temperature.

(4) There may be additional marking, which relates to the logo, the lot trace code information, or the environmental category on the device.

(5) Multiple Device Markings will be inside parentheses. Only one Device Marking contained in parentheses and separated by a "~" will appear on a device. If a line is indented then it is a continuation of the previous line and the two combined represent the entire Device Marking for that device.

(6) Lead/Ball Finish - Orderable Devices may have multiple material finish options. Finish options are separated by a vertical ruled line. Lead/Ball Finish values may wrap to two lines if the finish value exceeds the maximum column width.

Important Information and Disclaimer: The information provided on this page represents TI's knowledge and belief as of the date that it is provided. TI bases its knowledge and belief on information provided by third parties, and makes no representation or warranty as to the accuracy of such information. Efforts are underway to better integrate information from third parties. TI has taken and

continues to take reasonable steps to provide representative and accurate information but may not have conducted destructive testing or chemical analysis on incoming materials and chemicals. TI and TI suppliers consider certain information to be proprietary, and thus CAS numbers and other limited information may not be available for release.

In no event shall TI's liability arising out of such information exceed the total purchase price of the TI part(s) at issue in this document sold by TI to Customer on an annual basis.

TAPE AND REEL INFORMATION



QUADRANT ASSIGNMENTS FOR PIN 1 ORIENTATION IN TAPE



*All dimensions are nominal

| Device | Package Type | Package Drawing | Pins | SPQ | Reel Diameter (mm) | Reel Width W1 (mm) | A0 (mm) | B0 (mm) | K0 (mm) | P1 (mm) | W (mm) | Pin1 Quadrant |
|-----------------|--------------|-----------------|------|------|--------------------|--------------------|---------|---------|---------|---------|--------|---------------|
| LMH6628MAX/NOPB | SOIC | D | 8 | 2500 | 330.0 | 12.4 | 6.5 | 5.4 | 2.0 | 8.0 | 12.0 | Q1 |

TAPE AND REEL BOX DIMENSIONS



*All dimensions are nominal

| Device | Package Type | Package Drawing | Pins | SPQ | Length (mm) | Width (mm) | Height (mm) |
|-----------------|--------------|-----------------|------|------|-------------|------------|-------------|
| LMH6628MAX/NOPB | SOIC | D | 8 | 2500 | 367.0 | 367.0 | 35.0 |

D (R-PDSO-G8)

PLASTIC SMALL OUTLINE

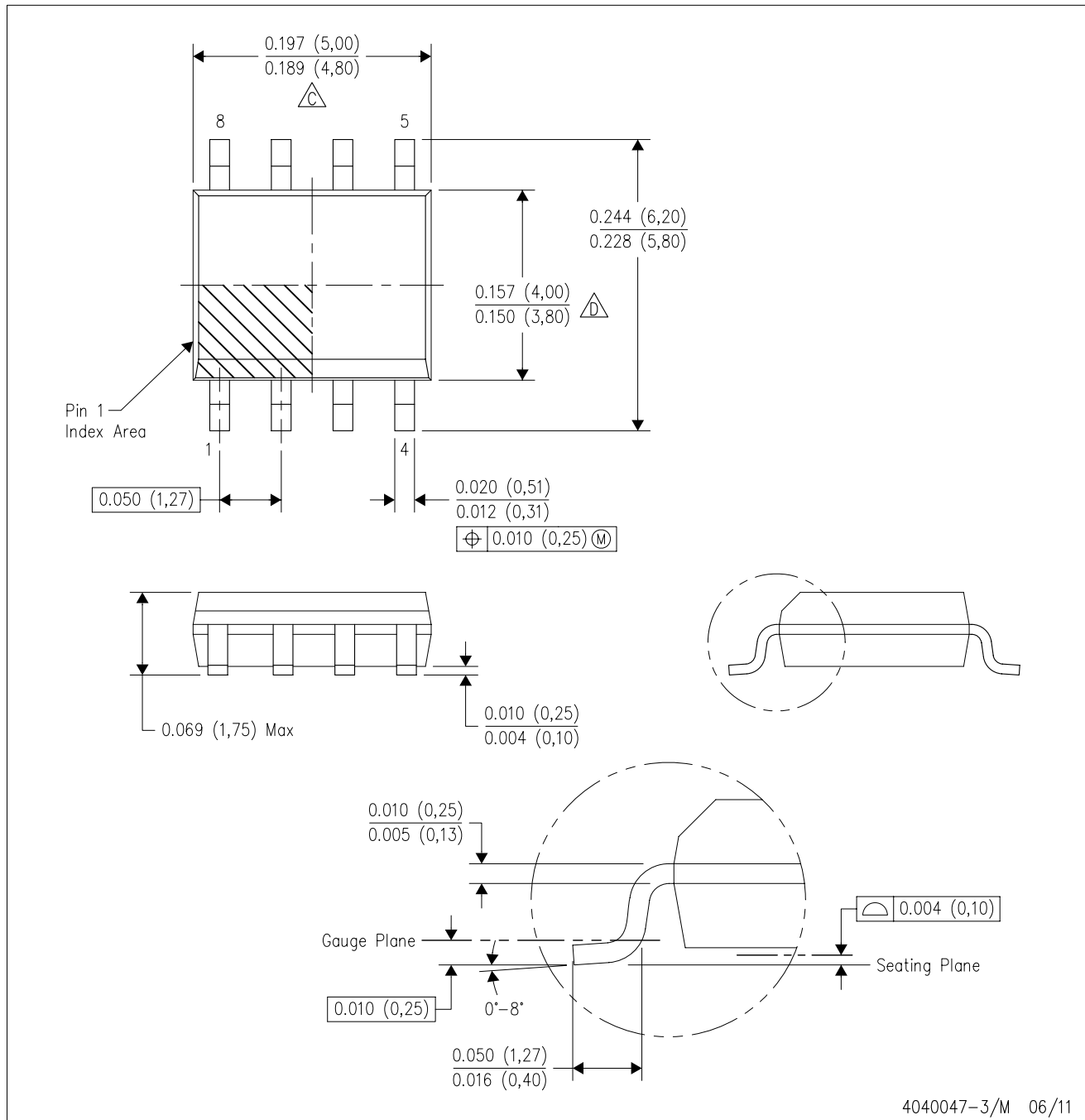

4040047-3/M 06/11

IMPORTANT NOTICE

Texas Instruments Incorporated and its subsidiaries (TI) reserve the right to make corrections, enhancements, improvements and other changes to its semiconductor products and services per JESD46, latest issue, and to discontinue any product or service per JESD48, latest issue. Buyers should obtain the latest relevant information before placing orders and should verify that such information is current and complete. All semiconductor products (also referred to herein as "components") are sold subject to TI's terms and conditions of sale supplied at the time of order acknowledgment.

TI warrants performance of its components to the specifications applicable at the time of sale, in accordance with the warranty in TI's terms and conditions of sale of semiconductor products. Testing and other quality control techniques are used to the extent TI deems necessary to support this warranty. Except where mandated by applicable law, testing of all parameters of each component is not necessarily performed.

TI assumes no liability for applications assistance or the design of Buyers' products. Buyers are responsible for their products and applications using TI components. To minimize the risks associated with Buyers' products and applications, Buyers should provide adequate design and operating safeguards.

TI does not warrant or represent that any license, either express or implied, is granted under any patent right, copyright, mask work right, or other intellectual property right relating to any combination, machine, or process in which TI components or services are used. Information published by TI regarding third-party products or services does not constitute a license to use such products or services or a warranty or endorsement thereof. Use of such information may require a license from a third party under the patents or other intellectual property of the third party, or a license from TI under the patents or other intellectual property of TI.

Reproduction of significant portions of TI information in TI data books or data sheets is permissible only if reproduction is without alteration and is accompanied by all associated warranties, conditions, limitations, and notices. TI is not responsible or liable for such altered documentation. Information of third parties may be subject to additional restrictions.

Resale of TI components or services with statements different from or beyond the parameters stated by TI for that component or service voids all express and any implied warranties for the associated TI component or service and is an unfair and deceptive business practice. TI is not responsible or liable for any such statements.

Buyer acknowledges and agrees that it is solely responsible for compliance with all legal, regulatory and safety-related requirements concerning its products, and any use of TI components in its applications, notwithstanding any applications-related information or support that may be provided by TI. Buyer represents and agrees that it has all the necessary expertise to create and implement safeguards which anticipate dangerous consequences of failures, monitor failures and their consequences, lessen the likelihood of failures that might cause harm and take appropriate remedial actions. Buyer will fully indemnify TI and its representatives against any damages arising out of the use of any TI components in safety-critical applications.

In some cases, TI components may be promoted specifically to facilitate safety-related applications. With such components, TI's goal is to help enable customers to design and create their own end-product solutions that meet applicable functional safety standards and requirements. Nonetheless, such components are subject to these terms.

No TI components are authorized for use in FDA Class III (or similar life-critical medical equipment) unless authorized officers of the parties have executed a special agreement specifically governing such use.

Only those TI components which TI has specifically designated as military grade or "enhanced plastic" are designed and intended for use in military/aerospace applications or environments. Buyer acknowledges and agrees that any military or aerospace use of TI components which have **not** been so designated is solely at the Buyer's risk, and that Buyer is solely responsible for compliance with all legal and regulatory requirements in connection with such use.

TI has specifically designated certain components as meeting ISO/TS16949 requirements, mainly for automotive use. In any case of use of non-designated products, TI will not be responsible for any failure to meet ISO/TS16949.

Products

| | |
|------------------------------|--|
| Audio | www.ti.com/audio |
| Amplifiers | amplifier.ti.com |
| Data Converters | dataconverter.ti.com |
| DLP® Products | www.dlp.com |
| DSP | dsp.ti.com |
| Clocks and Timers | www.ti.com/clocks |
| Interface | interface.ti.com |
| Logic | logic.ti.com |
| Power Mgmt | power.ti.com |
| Microcontrollers | microcontroller.ti.com |
| RFID | www.ti-rfid.com |
| OMAP Applications Processors | www.ti.com/omap |
| Wireless Connectivity | www.ti.com/wirelessconnectivity |

Applications

| | |
|-------------------------------|--|
| Automotive and Transportation | www.ti.com/automotive |
| Communications and Telecom | www.ti.com/communications |
| Computers and Peripherals | www.ti.com/computers |
| Consumer Electronics | www.ti.com/consumer-apps |
| Energy and Lighting | www.ti.com/energy |
| Industrial | www.ti.com/industrial |
| Medical | www.ti.com/medical |
| Security | www.ti.com/security |
| Space, Avionics and Defense | www.ti.com/space-avionics-defense |
| Video and Imaging | www.ti.com/video |

TI E2E Community

e2e.ti.com