

## LMH6732 High Speed Op Amp with Adjustable Bandwidth

Check for Samples: [LMH6732](#)

### FEATURES

- Exceptional Performance at Any Supply Current:  
 $V_S = \pm 5V$ ,  $T_A = 25^\circ C$ ,  $A_V = +2V/V$ ,  $V_{OUT} = 2V_{PP}$ ,  
Typical unless Noted:

$I_{CC}$ (mA)	-3dB BW (MHz)	DG/DP (%/deg.) PAL	Slew Rate (V/ $\mu$ s)	THD 1MHz (dBc)	Output Current (mA)
1.0	55	0.20 / 0.036	400	-70.0	9
3.4	180	0.022 / 0.017	2100	-78.5	45
9.0	540	0.025 / 0.010	2700	-79.6	115

- Ultra High Speed (-3dB BW) 1.5GHz ( $I_{CC} = 10mA$ ,  $0.25V_{PP}$ )
- Single Resistor Adjustability of Supply Current
- Fast Enable/ Disable Capability 20ns ( $I_{CC} = 9mA$ )
- "Popless" Output on "Enable" 15mV ( $I_{CC} = 1mA$ )
- Ultra Low Disable Current  $<1\mu A$
- Unity Gain Stable
- Improved Replacement for CLC505 & CLC449

### APPLICATIONS

- Battery Powered Systems
- Video Switching and Distribution
- Remote Site Instrumentation
- Mobile Communications Gear

### DESCRIPTION

The LMH6732 is a high speed op amp with a unique combination of high performance, low power consumption, and flexibility of application. The supply current is adjustable, over a continuous range of more than 10 to 1, with a single resistor,  $R_P$ . This feature allows the device to be used in a wide variety of high performance applications including device turn on/ turn off (Enable/ Disable) for power saving or multiplexing. Typical performance at any supply current is exceptional. The LMH6732's design has been optimized so that the output is well behaved, eliminating spurious outputs on "Enable".

The LMH6732's combination of high performance, low power consumption, and large signal performance makes it ideal for a wide variety of remote site equipment applications such as battery powered test instrumentation and communications gear. Other applications include video switching matrices, ATE and phased array radar systems.

The LMH6732 is available in the SOIC and SOT-23 packages. To reduce design times and assist in board layout, the LMH6732 is supported by an evaluation board.

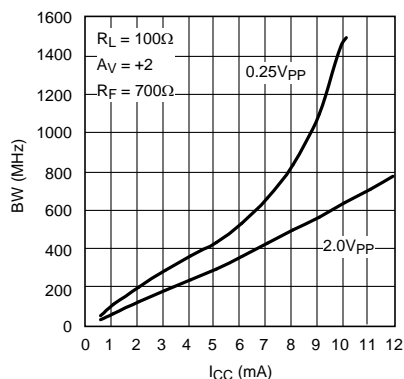
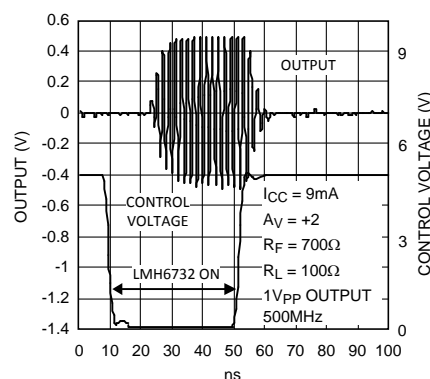
**Figure 1. -3dB BW vs.  $I_{CC}$** 

**Figure 2. Turn-On/Off Characteristics**

Please be aware that an important notice concerning availability, standard warranty, and use in critical applications of Texas Instruments semiconductor products and disclaimers thereto appears at the end of this data sheet.

All trademarks are the property of their respective owners.



These devices have limited built-in ESD protection. The leads should be shorted together or the device placed in conductive foam during storage or handling to prevent electrostatic damage to the MOS gates.

### Absolute Maximum Ratings<sup>(1)(2)</sup>

$V_S$		$\pm 6.75V$
$I_{OUT}$		See <sup>(3)</sup>
$I_{CC}$		14mA
Common Mode Input Voltage		$V^-$ to $V^+$
Maximum Junction Temperature		+150°C
Storage Temperature Range		-65°C to +150°C
Soldering Information	Infrared or Convection (20 sec)	235°C
	Wave Soldering (10 sec)	260°C
ESD Tolerance <sup>(4)</sup>	Human Body Model	2000V
	Machine Model	200V

- (1) Absolute Maximum Ratings indicate limits beyond which damage to the device may occur. Operating Ratings indicate conditions for which the device is intended to be functional, but specific performance is not ensured. For ensured specifications, see the Electrical Characteristics tables.
- (2) If Military/Aerospace specified devices are required, please contact the Texas Instruments Sales Office/Distributors for availability and specifications..
- (3) The maximum output current ( $I_O$ ) is determined by device power dissipation limitations.
- (4) Human body model: 1.5k $\Omega$  in series with 100pF. Machine model: 0 $\Omega$  in series with 200pF.

### Operating Ratings<sup>(1)</sup>

Thermal Resistance		
Package	$\theta_{JC}$ (°C/W)	$\theta_{JA}$ (°C/W)
8-Pin SOIC	65°C/W	166°C/W
6-Pin SOT-23	120°C/W	198°C/W
Operating Temperature	-40°C to +85°C	
Nominal Supply Voltage	$\pm 4.5V$ to $\pm 6V$	
Operating Supply Current	0.5mA < $I_{CC}$ < 12mA	

- (1) Absolute Maximum Ratings indicate limits beyond which damage to the device may occur. Operating Ratings indicate conditions for which the device is intended to be functional, but specific performance is not ensured. For ensured specifications, see the Electrical Characteristics tables.

**Electrical Characteristics  $I_{CC} = 9\text{mA}^{(1)}$** 
 $A_V = +2$ ,  $R_F = 700\Omega$ ,  $V_S = \pm 5\text{V}$ ,  $R_L = 100\Omega$ ,  $R_P = 39\text{k}\Omega$ ; Unless otherwise specified.

Symbol	Parameter	Conditions	Min <sup>(2)</sup>	Typ <sup>(2)</sup>	Max <sup>(2)</sup>	Units
<b>Frequency Domain Response</b>						
SSBW	-3dB Bandwidth	$V_{OUT} = 2V_{PP}$		540		MHz
LSBW	-3dB Bandwidth	$V_{OUT} = 4.0V_{PP}$		315		MHz
$GF_{0.1dB}$	0.1dB Gain Flatness	$V_{OUT} = 2V_{PP}$		180		MHz
GFP	Frequency Response Peaking	DC to 200MHz, $V_{OUT} = 2V_{PP}$		0.01		dB
GFR	Frequency Response Rolloff	DC to 200MHz, $V_{OUT} = 2V_{PP}$		0.15		dB
LPD	Linear Phase Deviation	DC to 200MHz, $V_{OUT} = 2V_{PP}$		0.6		deg
		DC to 140MHz, $V_{OUT} = 2V_{PP}$		0.1		
DG	Differential Gain	$R_L = 150\Omega$ , 4.43MHz		0.025		%
DP	Differential Phase	$R_L = 150\Omega$ , 4.43MHz		0.010		deg
<b>Time Domain Response</b>						
TRS	Rise Time	2V Step		0.8		ns
TRL	Fall Time	2V Step		0.9		
$T_S$	Settling Time to 0.04%	$A_V = -1$ , 2V Step		18		ns
OS	Overshoot	2V Step		1		%
SR	Slew Rate	5V Step, 40% to 60% <sup>(3)</sup>		2700		V/ $\mu$ s
<b>Distortion And Noise Response</b>						
HD2	2nd Harmonic Distortion	$2V_{PP}$ , 20MHz		-60		dBc
HD3	3rd Harmonic Distortion	$2V_{PP}$ , 20MHz		-64		dBc
THD	Total Harmonic Distortion	$2V_{PP}$ , 1MHz		-79.6		dBc
$V_N$	Input Referred Voltage Noise	>1MHz		2.5		$\text{nV}/\sqrt{\text{Hz}}$
$I_N$	Input Referred Inverting Noise Current	>1MHz		9.7		$\text{pA}/\sqrt{\text{Hz}}$
$I_{NN}$	Input Referred Non-Inverting Noise Current	>1MHz		1.8		$\text{pA}/\sqrt{\text{Hz}}$
SNF	Noise Floor	>1MHz		-154		$\text{dBm}_{1\text{Hz}}$
INV	Total Integrated Input Noise	1MHz to 200MHz		60		$\mu\text{V}$

- (1) Electrical Table values apply only for factory testing conditions at the temperature indicated. Factory testing conditions result in very limited self-heating of the device such that  $T_J = T_A$ . No ensured specification of parametric performance is indicated in the electrical tables under conditions of internal self-heating where  $T_J > T_A$ . Min/Max ratings are based on production testing unless otherwise specified.
- (2) Typical numbers are the most likely parametric norm. Bold numbers refer to over temperature limits.
- (3) Slew Rate is the average of the rising and falling edges.

**Electrical Characteristics  $I_{CC} = 9\text{mA}^{(1)}$  (continued)**
 $A_V = +2$ ,  $R_F = 700\Omega$ ,  $V_S = \pm 5\text{V}$ ,  $R_L = 100\Omega$ ,  $R_P = 39\text{k}\Omega$ ; Unless otherwise specified.

Symbol	Parameter	Conditions	Min <sup>(2)</sup>	Typ <sup>(2)</sup>	Max <sup>(2)</sup>	Units
<b>Static, DC Performance</b>						
$V_{IO}$	Input Offset Voltage			$\pm 3.0$	$\pm 8.0$ <b>9.9</b>	mV
$DV_{IO}$	Input Offset Voltage Average Drift	See <sup>(4)</sup>		16		$\mu\text{V}/^\circ\text{C}$
$I_{BN}$	Input Bias Current	Non Inverting <sup>(5)</sup>		-2	$\pm 11$ <b><math>\pm 12</math></b>	$\mu\text{A}$
$DI_{BN}$	Input Bias Current Average Drift	Non-Inverting <sup>(4)</sup>		5		$\text{nA}/^\circ\text{C}$
$I_{BI}$	Input Bias Current	Inverting <sup>(5)</sup>		-9	$\pm 20$ <b><math>\pm 30</math></b>	$\mu\text{A}$
$DI_{BI}$	Input Bias Current Average Drift	Inverting <sup>(4)</sup>		-14		$\text{nA}/^\circ\text{C}$
+PSRR	Positive Power Supply Rejection Ratio	DC	52 <b>50</b>	62		dB
-PSRR	Negative Power Supply Rejection Ratio	DC	51 <b>48</b>	56		dB
CMRR	Common Mode Rejection Ratio	DC	49 <b>46</b>	52		dB
$I_{CC}$	Supply Current	$R_L = \infty$ , $R_P = 39\text{k}\Omega$	7.5 <b>6.6</b>	9.0	10.5 <b>11.7</b>	mA
$I_{CC}^{\text{I}}$	Supply Current During Shutdown			<1		$\mu\text{A}$
<b>Miscellaneous Performance</b>						
$R_{IN}$	Input Resistance	Non-Inverting		4.7		$\text{M}\Omega$
$C_{IN}$	Input Capacitance	Non-Inverting		1.8		pF
$R_{OUT}$	Output Resistance	Closed Loop		32		$\text{m}\Omega$
$V_O$	Output Voltage Range	$R_L = \infty$	$\pm 3.60$ <b><math>\pm 3.55</math></b>	$\pm 3.75$		V
$V_{OL}$		$R_L = 100\Omega$	$\pm 2.90$ <b><math>\pm 2.85</math></b>	$\pm 3.10$		
CMIR	Common Mode Input Range	Common Mode		$\pm 2.2$		V
$I_O$	Output Current	Closed Loop $-40\text{mV} \leq V_O \leq 40\text{mV}$	$\pm 75$	$\pm 115$		mA
TON	Turn-on Time	0.5V <sub>PP</sub> Sine Wave, 90% of Full Value		20		ns
TOFF	Turn-off Time	0.5V <sub>PP</sub> Sine Wave, <5% of Full Value		9		
$V_{O \text{ glitch}}$	Turn-on Glitch			50		mV
FDTH	Feed-Through	$f = 10\text{MHz}$ , $A_V = +2$ , Off State		-61		dB

(4) Drift determined by dividing the change in parameter distribution average at temperature extremes by the total temperature change

(5) Negative input current implies current flowing out of the device.

**Electrical Characteristics  $I_{CC} = 3.4\text{mA}^{(1)}$** 
 $A_V = +2$ ,  $R_F = 1\text{k}\Omega$ ,  $V_S = \pm 5\text{V}$ ,  $R_L = 100\Omega$ ,  $R_P = 137\text{k}\Omega$ ; Unless otherwise specified.

Symbol	Parameter	Conditions	Min (2)	Typ (2)	Max (2)	Units
<b>Frequency Domain Response</b>						
SSBW	-3dB Bandwidth	$V_{OUT} = 2V_{PP}$		180		MHz
LSBW	-3dB Bandwidth	$V_{OUT} = 4.0V_{PP}$		100		MHz
$GF_{0.1dB}$	0.1dB Gain Flatness	$V_{OUT} = 2V_{PP}$		50		MHz
GFP	Frequency Response Peaking	DC to 75MHz, $V_{OUT} = 2V_{PP}$		0.15		dB
GFR	Frequency Response Rolloff	DC to 75MHz, $V_{OUT} = 2V_{PP}$		0.05		dB
LPD	Linear Phase Deviation	DC to 55MHz, $V_{OUT} = 2V_{PP}$		0.5		deg
		DC to 25MHz, $V_{OUT} = 2V_{PP}$		0.1		
DG	Differential Gain	$R_L = 150\Omega$ , 4.43MHz		0.022		%
DP	Differential Phase	$R_L = 150\Omega$ , 4.43MHz		0.017		deg
<b>Time Domain Response</b>						
TRS	Rise Time	2V Step		1.7		ns
TRL	Fall Time	2V Step		2.1		
$T_S$	Settling Time to 0.04%	$A_V = -1$ , 2V Step		18		ns
OS	Overshoot	2V Step		2		%
SR	Slew Rate	5V Step, 40% to 60% <sup>(3)</sup>		2100		V/ $\mu\text{s}$
<b>Distortion And Noise Response</b>						
HD2	2nd Harmonic Distortion	$2V_{PP}$ , 10MHz		-51		dBc
HD3	3rd Harmonic Distortion	$2V_{PP}$ , 10MHz		-65		dBc
THD	Total Harmonic Distortion	$2V_{PP}$ , 1MHz		-78.5		dBc
$V_N$	Input Referred Voltage Noise	>1MHz		4.1		nV/ $\sqrt{\text{Hz}}$
$I_N$	Input Referred Inverting Noise Current	>1MHz		8.8		pA/ $\sqrt{\text{Hz}}$
$I_{NN}$	Input Referred Non-Inverting Noise Current	>1MHz		1.1		pA/ $\sqrt{\text{Hz}}$
SNF	Noise Floor	>1MHz		-151		dBm <sub>1Hz</sub>
INV	Total Integrated Input Noise	1MHz to 100MHz		60		$\mu\text{V}$

- (1) Electrical Table values apply only for factory testing conditions at the temperature indicated. Factory testing conditions result in very limited self-heating of the device such that  $T_J = T_A$ . No ensured specification of parametric performance is indicated in the electrical tables under conditions of internal self-heating where  $T_J > T_A$ . Min/Max ratings are based on production testing unless otherwise specified.
- (2) Typical numbers are the most likely parametric norm. Bold numbers refer to over temperature limits.
- (3) Slew Rate is the average of the rising and falling edges.

**Electrical Characteristics  $I_{CC} = 3.4\text{mA}^{(1)}$  (continued)**
 $A_V = +2$ ,  $R_F = 1\text{k}\Omega$ ,  $V_S = \pm 5\text{V}$ ,  $R_L = 100\Omega$ ,  $R_P = 137\text{k}\Omega$ ; Unless otherwise specified.

Symbol	Parameter	Conditions	Min (2)	Typ (2)	Max (2)	Units
<b>Static, DC Performance</b>						
$V_{IO}$	Input Offset Voltage			$\pm 2.5$	$\pm 7.0$ $\pm 8.5$	mV
$DV_{IO}$	Input Offset Voltage Average Drift	See <sup>(4)</sup>		10		$\mu\text{V}/^\circ\text{C}$
$I_{BN}$	Input Bias Current	Non Inverting <sup>(5)</sup>		-0.4	$\pm 4$ $\pm 6$	$\mu\text{A}$
$DI_{BN}$	Input Bias Current Average Drift	Non-Inverting <sup>(4)</sup>		8		$\text{nA}/^\circ\text{C}$
$I_{BI}$	Input Bias Current	Inverting <sup>(5)</sup>		-1	$\pm 12$ $\pm 16$	$\mu\text{A}$
$DI_{BI}$	Input Bias Current Average Drift	Inverting <sup>(4)</sup>		-3		$\text{nA}/^\circ\text{C}$
+PSRR	Positive Power Supply Rejection Ratio	DC	52 50	64		dB
-PSRR	Negative Power Supply Rejection Ratio	DC	51 50	57		dB
CMRR	Common Mode Rejection Ratio	DC	49 48	55		dB
$I_{CC}$	Supply Current	$R_L = \infty$ , $R_P = 137\text{k}\Omega$	2.8 2.6	3.4	3.9 4.1	mA
$I_{CC}$	Supply Current During Shutdown			<1		$\mu\text{A}$
<b>Miscellaneous Performance</b>						
$R_{IN}$	Input Resistance	Non-Inverting		15		M $\Omega$
$C_{IN}$	Input Capacitance	Non-Inverting		1.7		pF
$R_{OUT}$	Output Resistance	Closed Loop		50		m $\Omega$
$V_O$	Output Voltage Range	$R_L = \infty$	$\pm 3.60$ $\pm 3.55$	$\pm 3.78$		V
$V_{OL}$		$R_L = 100\Omega$	$\pm 2.90$ $\pm 2.85$	$\pm 3.10$		
CMIR	Common Mode Input Range	Common Mode		$\pm 2.2$		V
$I_O$	Output Current	Closed Loop $-20\text{mV} \leq V_O \leq 20\text{mV}$	$\pm 30$	$\pm 45$		mA
TON	Turn-on Time	0.5V <sub>PP</sub> Sine Wave, 90% of Full Value		42		ns
TOFF	Turn-off Time	0.5V <sub>PP</sub> Sine Wave, <5% of Full Value		10		
$V_{O\text{ glitch}}$	Turn-on Glitch			25		mV
FDTH	Feed-Through	$f = 10\text{MHz}$ , $A_V = +2$ , Off State		-61		dB

(4) Drift determined by dividing the change in parameter distribution average at temperature extremes by the total temperature change

(5) Negative input current implies current flowing out of the device.

**Electrical Characteristics  $I_{CC} = 1.0\text{mA}^{(1)}$** 
 $A_V = +2$ ,  $R_F = 1\text{k}\Omega$ ,  $V_S = \pm 5\text{V}$ ,  $R_L = 500\Omega$ ,  $R_P = 412\text{k}\Omega$ ; Unless otherwise specified.

Symbol	Parameter	Conditions	Min (2)	Typ (2)	Max (2)	Units
<b>Frequency Domain Response</b>						
SSBW	-3dB Bandwidth	$V_{OUT} = 2V_{PP}$		55		MHz
LSBW	-3dB Bandwidth	$V_{OUT} = 4.0V_{PP}$		30		MHz
$GF_{0.1dB}$	0.1dB Gain Flatness	$V_{OUT} = 2V_{PP}$		20		MHz
GFP	Frequency Response Peaking	DC to 25MHz, $V_{OUT} = 2V_{PP}$		0.11		dB
GFR	Frequency Response Rolloff	DC to 25MHz, $V_{OUT} = 2V_{PP}$		0.05		dB
LPD	Linear Phase Deviation	DC to 20MHz, $V_{OUT} = 2V_{PP}$		1		deg
		DC to 14MHz, $V_{OUT} = 2V_{PP}$		0.3		
DG	Differential Gain	$R_L = 500\Omega$ , 4.43MHz		0.020		%
DP	Differential Phase	$R_L = 500\Omega$ , 4.43MHz		0.036		deg
<b>Time Domain Response</b>						
TRS	Rise Time	2V Step		3.7		ns
TRL	Fall Time	2V Step		5.1		
$T_S$	Settling Time to 0.04%	$A_V = -1$ , 2V Step		18		ns
OS	Overshoot	2V Step		2		%
SR	Slew Rate	5V Step, 40% to 60% <sup>(3)</sup>		400		V/ $\mu$ s
<b>Distortion And Noise Response</b>						
HD2	2nd Harmonic Distortion	$2V_{PP}$ , 5MHz		-43		dBc
HD3	3rd Harmonic Distortion	$2V_{PP}$ , 5MHz		-65		dBc
THD	Total Harmonic Distortion	$2V_{PP}$ , 1MHz		-70.0		dBc
$V_N$	Input Referred Voltage Noise	>1MHz		8.4		nV/ $\sqrt{\text{Hz}}$
$I_N$	Input Referred Inverting Noise Current	>1MHz		9.0		pA/ $\sqrt{\text{Hz}}$
$I_{NN}$	Input Referred Non-Inverting Noise Current	>1MHz		0.8		pA/ $\sqrt{\text{Hz}}$
SNF	Noise Floor	>1MHz		-147		dBm <sub>1Hz</sub>
INV	Total Integrated Input Noise	1MHz to 100MHz		29		$\mu$ V

- (1) Electrical Table values apply only for factory testing conditions at the temperature indicated. Factory testing conditions result in very limited self-heating of the device such that  $T_J = T_A$ . No ensured specification of parametric performance is indicated in the electrical tables under conditions of internal self-heating where  $T_J > T_A$ . Min/Max ratings are based on production testing unless otherwise specified.
- (2) Typical numbers are the most likely parametric norm. Bold numbers refer to over temperature limits.
- (3) Slew Rate is the average of the rising and falling edges.

**Electrical Characteristics  $I_{CC} = 1.0\text{mA}^{(1)}$  (continued)**
 $A_V = +2$ ,  $R_F = 1\text{k}\Omega$ ,  $V_S = \pm 5\text{V}$ ,  $R_L = 500\Omega$ ,  $R_P = 412\text{k}\Omega$ ; Unless otherwise specified.

Symbol	Parameter	Conditions	Min (2)	Typ (2)	Max (2)	Units
<b>Static, DC Performance</b>						
$V_{IO}$	Input Offset Voltage			$\pm 1.6$	$\pm 6.0$ $\pm 7.3$	mV
$DV_{IO}$	Input Offset Voltage Average Drift	See <sup>(4)</sup>		4		$\mu\text{V}/^\circ\text{C}$
$I_{BN}$	Input Bias Current	Non Inverting <sup>(5)</sup>		0.04	$\pm 2.0$ $\pm 2.5$	$\mu\text{A}$
$DI_{BN}$	Input Bias Current Average Drift	Non-Inverting <sup>(4)</sup>		-1		$\text{nA}/^\circ\text{C}$
$I_{BI}$	Input Bias Current	Inverting <sup>(5)</sup>		-0.1	$\pm 6$ $\pm 8$	$\mu\text{A}$
$DI_{BI}$	Input Bias Current Average Drift	Inverting <sup>(4)</sup>		-3		$\text{nA}/^\circ\text{C}$
+PSRR	Positive Power Supply Rejection Ratio	DC	52 51	64		dB
-PSRR	Negative Power Supply Rejection Ratio	DC	51 49	59		dB
CMRR	Common Mode Rejection Ratio	DC	49 47	55		dB
$I_{CC}$	Supply Current	$R_L = \infty$ , $R_P = 412\text{k}\Omega$	0.70 0.66	1.0	1.3 1.4	mA
$I_{CC}$	Supply Current During Shutdown			<1		$\mu\text{A}$
<b>Miscellaneous Performance</b>						
$R_{IN}$	Input Resistance	Non-Inverting		46		M $\Omega$
$C_{IN}$	Input Capacitance	Non-Inverting		1.7		pF
$R_{OUT}$	Output Resistance	Closed Loop		100		m $\Omega$
$V_O$	Output Voltage Range	$R_L = \infty$	$\pm 3.60$ $\pm 3.55$	$\pm 3.78$		V
$V_{OL}$		$R_L = 500\Omega$	$\pm 2.90$ $\pm 2.85$	$\pm 3.10$		
CMIR	Common Mode Input Range	Common Mode		$\pm 2.2$		V
$I_O$	Output Current	Closed Loop $-15\text{mV} \leq V_O \leq 15\text{mV}$	$\pm 6$	$\pm 9$		mA
TON	Turn-on Time	0.5V <sub>PP</sub> Sine Wave, 90% of Full Value		95		ns
TOFF	Turn-off Time	0.5V <sub>PP</sub> Sine Wave, <5% of Full Value		40		
$V_{O\_glitch}$	Turn-on Glitch			15		mV
FDTH	Feed-Through	$f = 10\text{MHz}$ , $A_V = +2$ , Off State		-61		dB

(4) Drift determined by dividing the change in parameter distribution average at temperature extremes by the total temperature change

(5) Negative input current implies current flowing out of the device.

CONNECTION DIAGRAMS

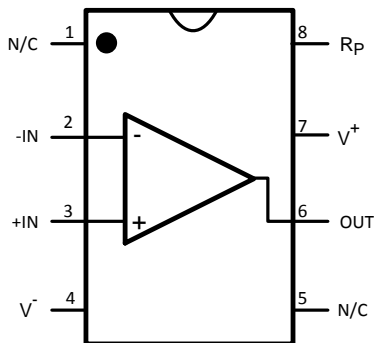

Figure 3. 8-Pin SOIC (Top View)  
See Package Number D (R-PDSO-G8)

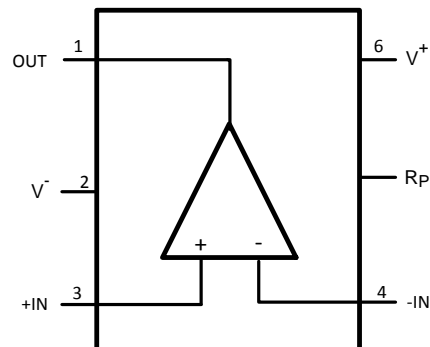

Figure 4. 6-Pin SOT-23 (Top View)  
See Package Number DBV (R-PDSO-G6)

TYPICAL PERFORMANCE CHARACTERISTICS

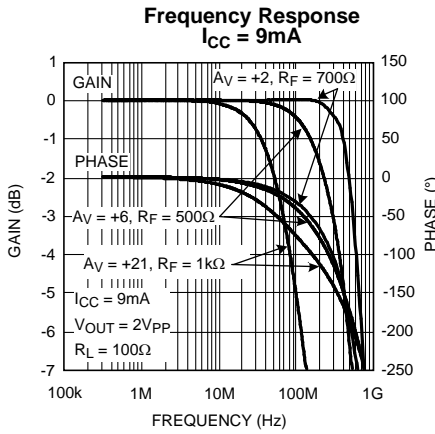

Figure 5.

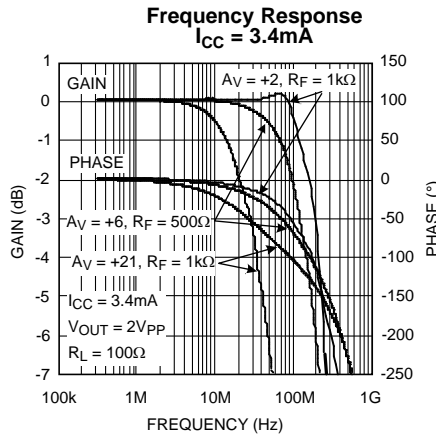

Figure 6.

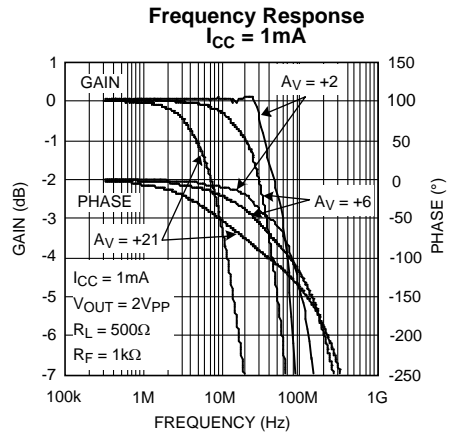

Figure 7.

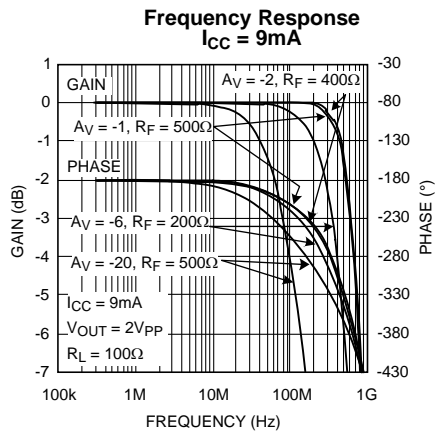

Figure 8.

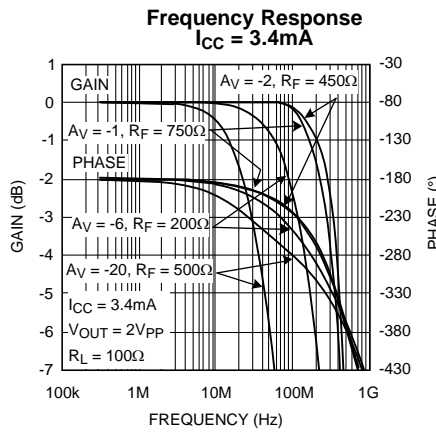

Figure 9.

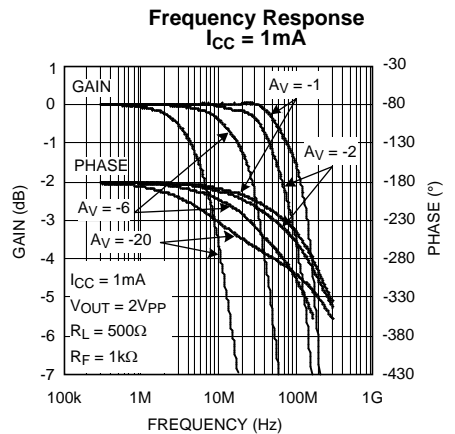

Figure 10.

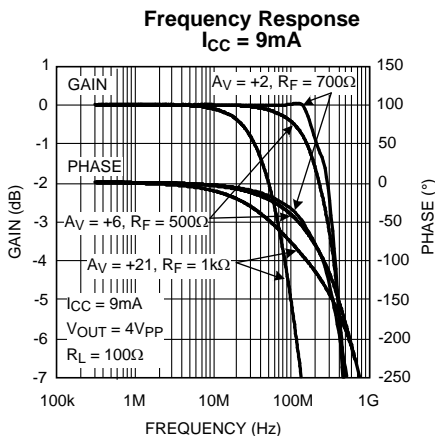

Figure 11.

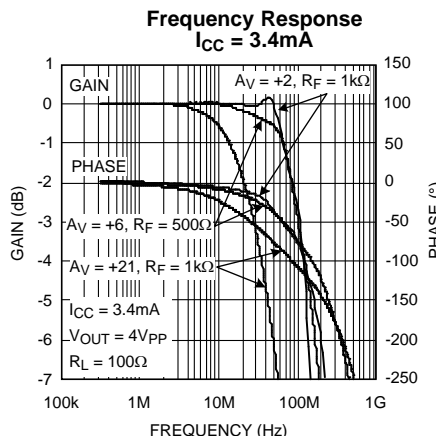

Figure 12.

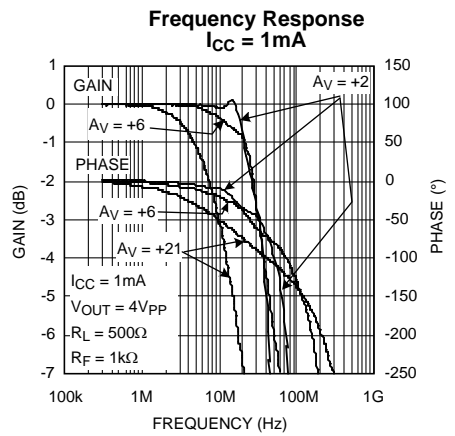

Figure 13.

TYPICAL PERFORMANCE CHARACTERISTICS (continued)

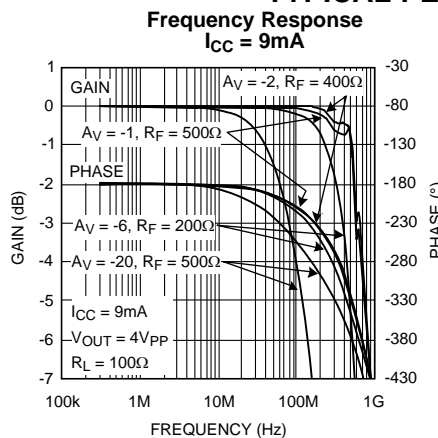

Figure 14.

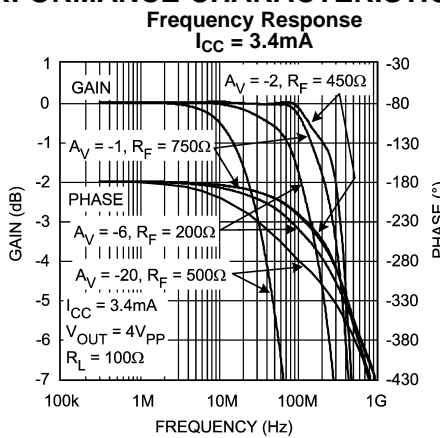

Figure 15.

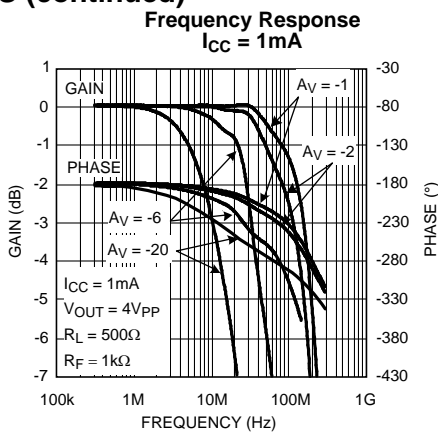

Figure 16.

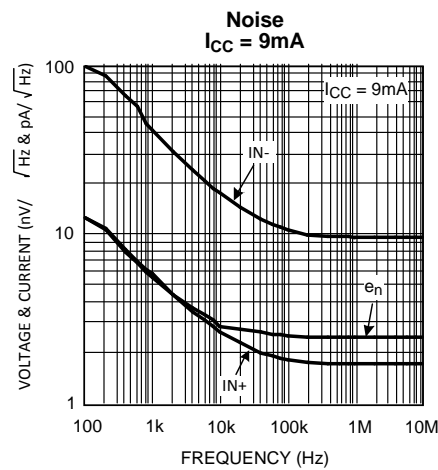

Figure 17.

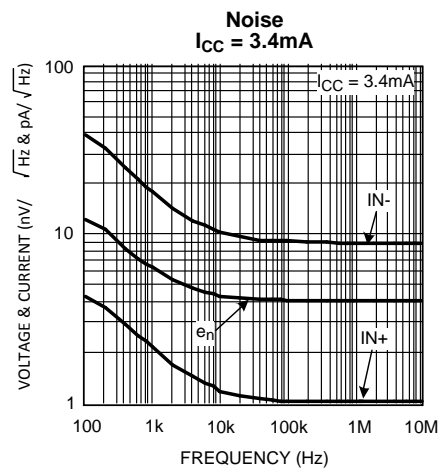

Figure 18.

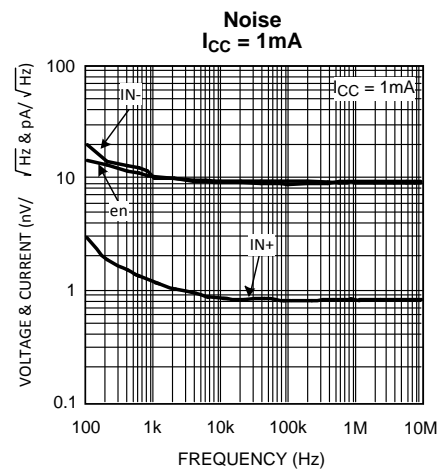

Figure 19.

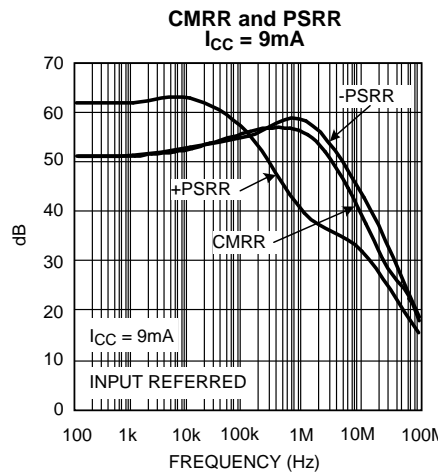

Figure 20.

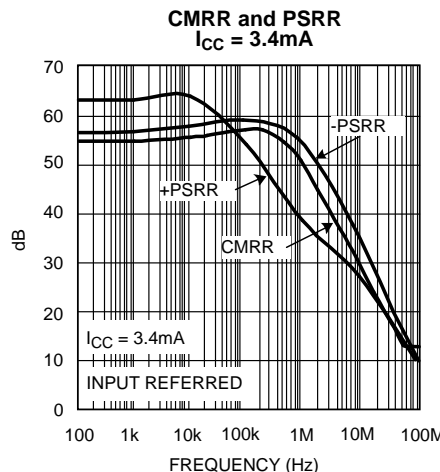

Figure 21.

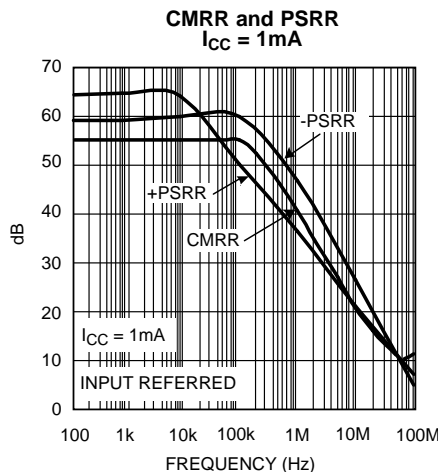

Figure 22.

**TYPICAL PERFORMANCE CHARACTERISTICS (continued)**

**2nd Distortion vs. Output Amplitude**  
 $I_{CC} = 9\text{mA}$

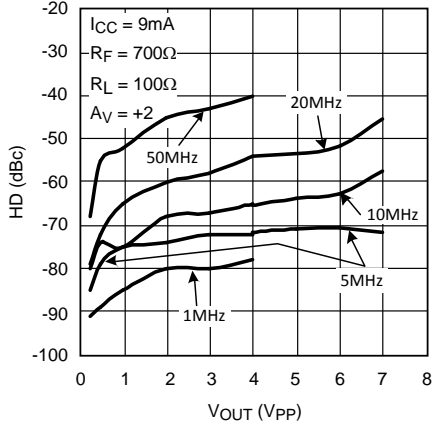

Figure 23.

**2nd Distortion vs. Output Amplitude**  
 $I_{CC} = 3.4\text{mA}$

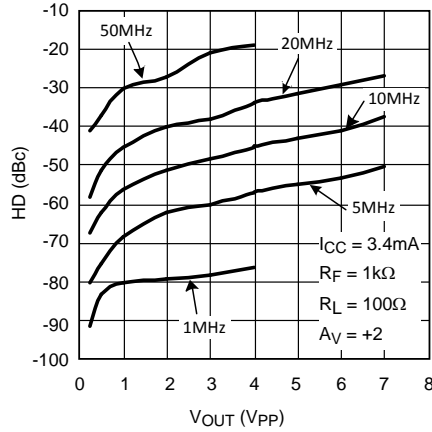

Figure 24.

**2nd Distortion vs. Output Amplitude**  
 $I_{CC} = 1\text{mA}$

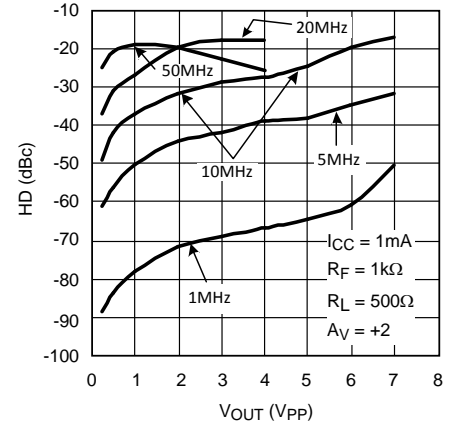

Figure 25.

**3rd Distortion vs. Output Amplitude**  
 $I_{CC} = 9\text{mA}$

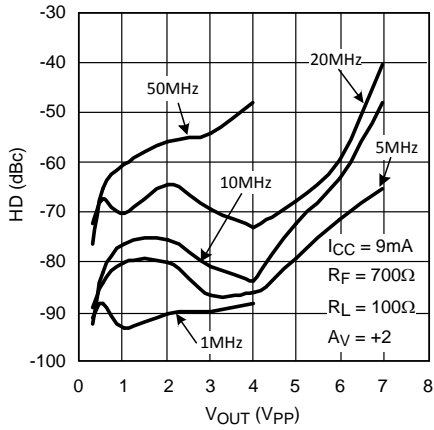

Figure 26.

**3rd Distortion vs. Output Amplitude**  
 $I_{CC} = 3.4\text{mA}$

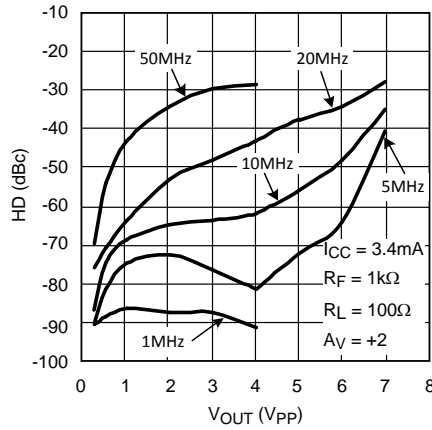

Figure 27.

**3rd Distortion vs. Output Amplitude**  
 $I_{CC} = 1\text{mA}$

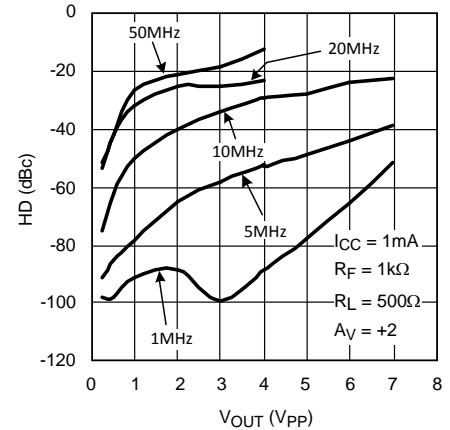

Figure 28.

**Frequency Response for Various  $C_L$**   
 $I_{CC} = 9\text{mA}$

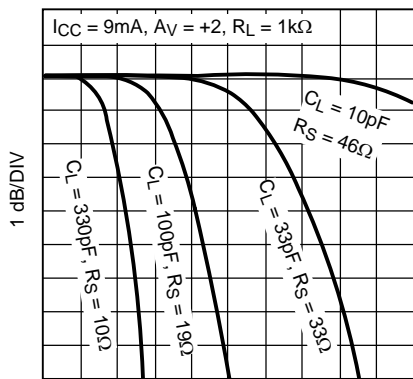

Figure 29.

**Frequency Response for Various  $C_L$**   
 $I_{CC} = 3.4\text{mA}$

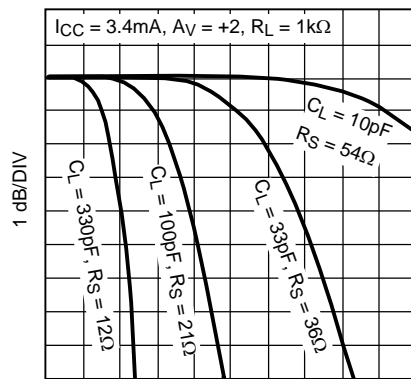

Figure 30.

**Frequency Response for Various  $C_L$**   
 $I_{CC} = 1\text{mA}$

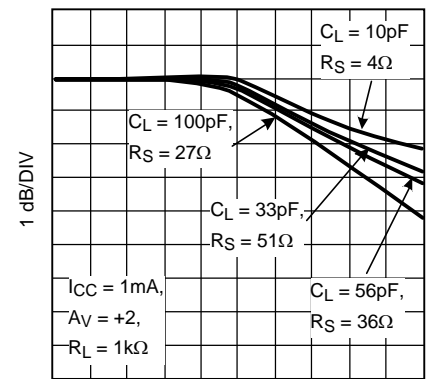

Figure 31.

**TYPICAL PERFORMANCE CHARACTERISTICS (continued)**

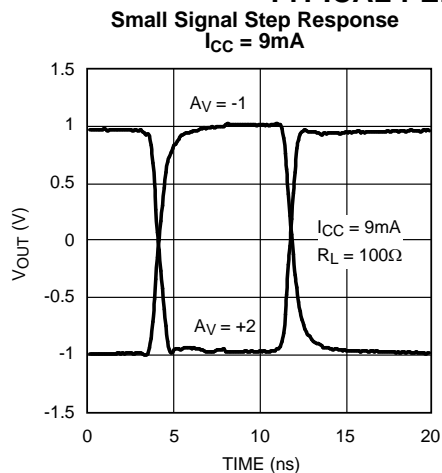

Figure 32.

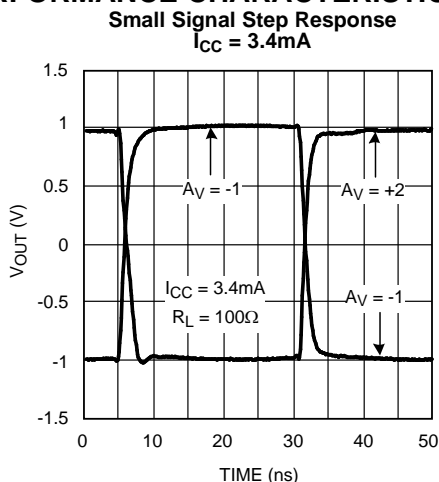

Figure 33.

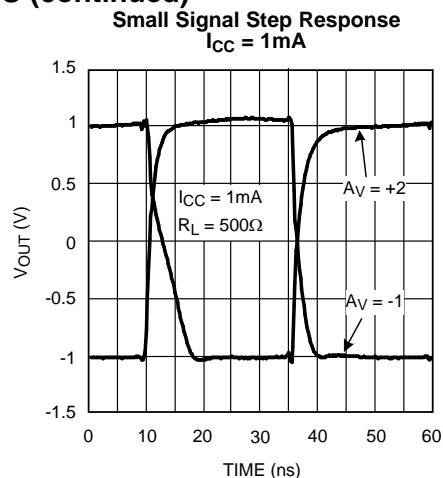

Figure 34.

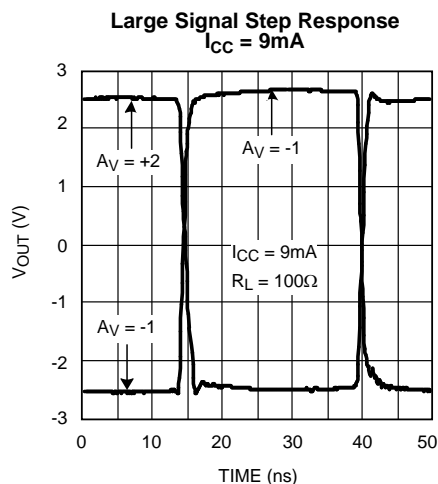

Figure 35.

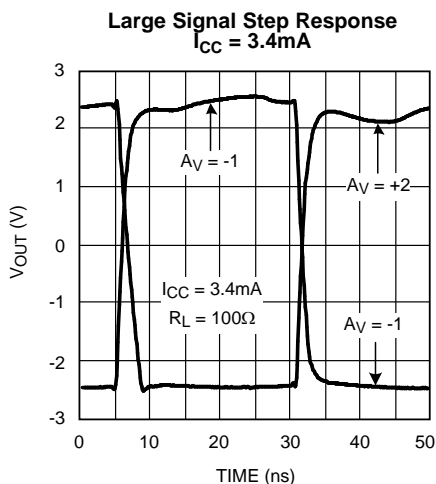

Figure 36.

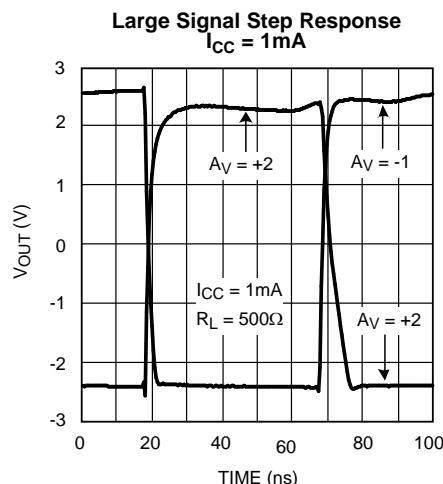

Figure 37.

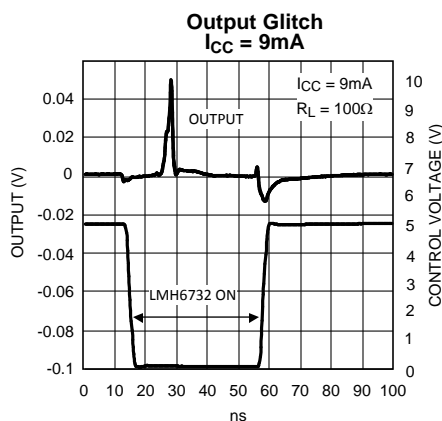

Figure 38.

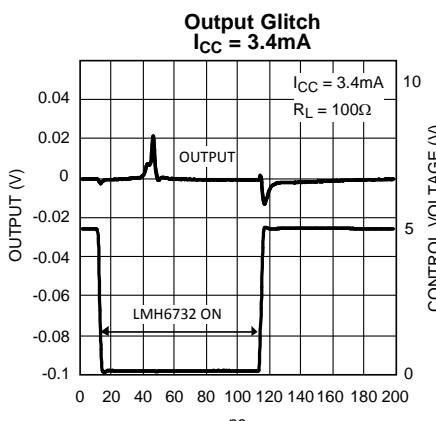

Figure 39.

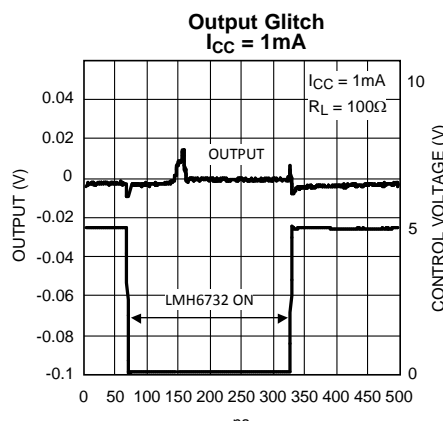

Figure 40.

**TYPICAL PERFORMANCE CHARACTERISTICS (continued)**

**Turn-On/Off Characteristics**  
 $I_{CC} = 9\text{mA}$

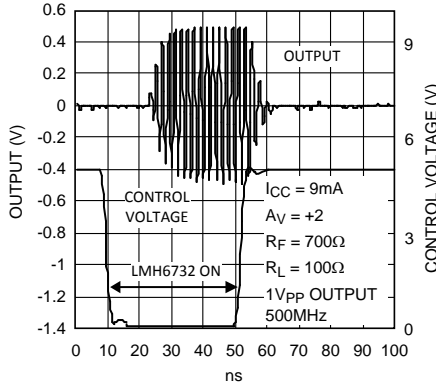

Figure 41.

**Turn-On/Off Characteristics**  
 $I_{CC} = 3.4\text{mA}$

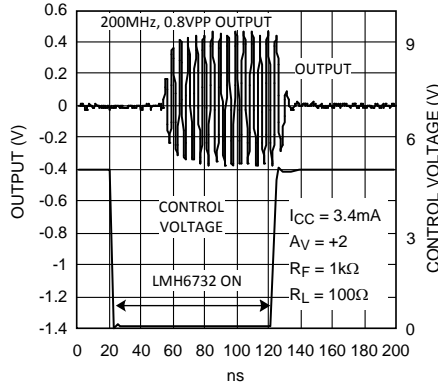

Figure 42.

**Turn-On/Off Characteristics**  
 $I_{CC} = 1\text{mA}$

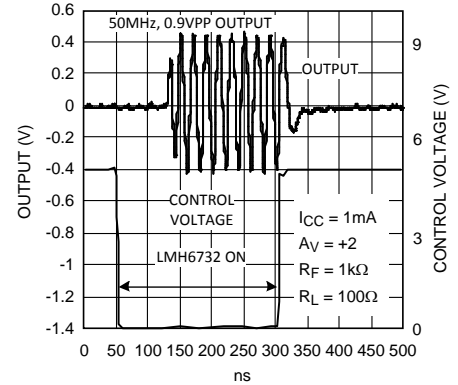

Figure 43.

**$I_{CC}$  vs.  $R_P$**

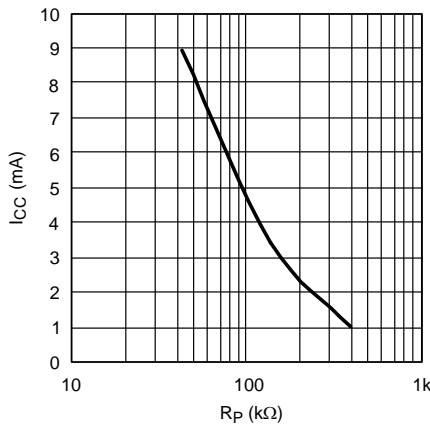

Figure 44.

**$I_P$  vs.  $I_{CC}$**

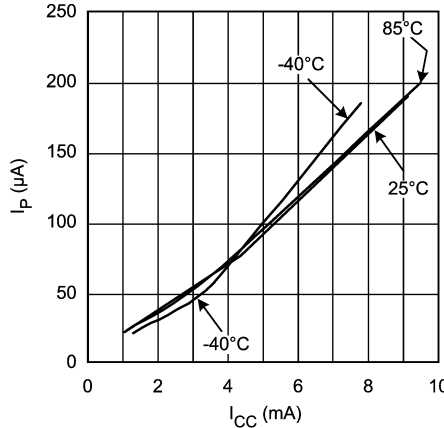

Figure 45.

**Max Output Current vs.  $I_{CC}$**

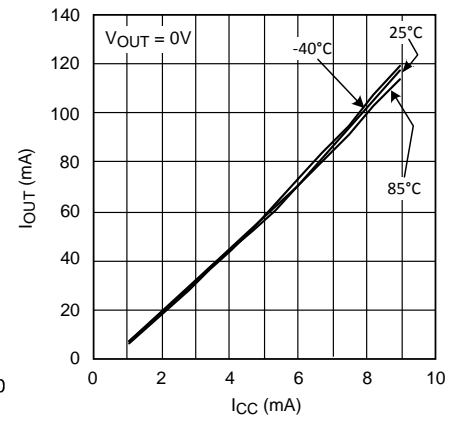

Figure 46.

**Slew Rate vs.  $I_{CC}$**

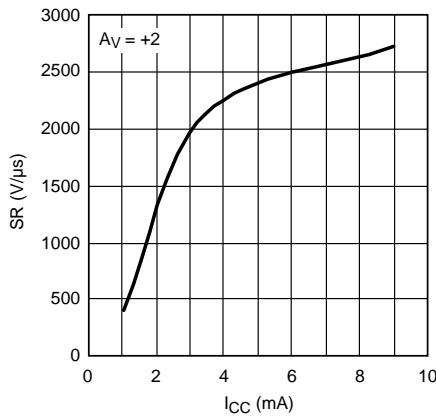

Figure 47.

**BW vs.  $I_{CC}$**

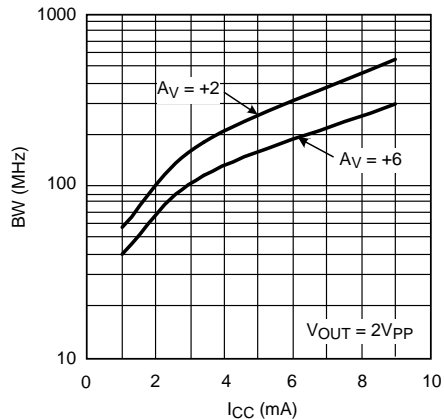

Figure 48.

**BW vs.  $I_{CC}$  for Various Temperature**

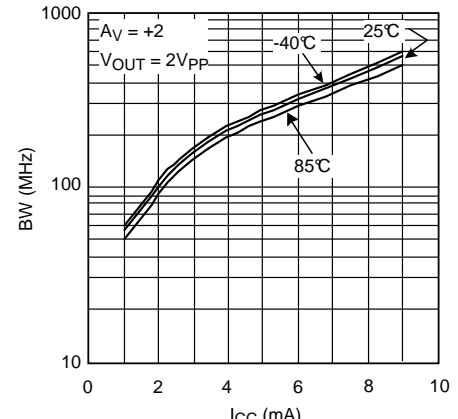

Figure 49.

**TYPICAL PERFORMANCE CHARACTERISTICS (continued)**

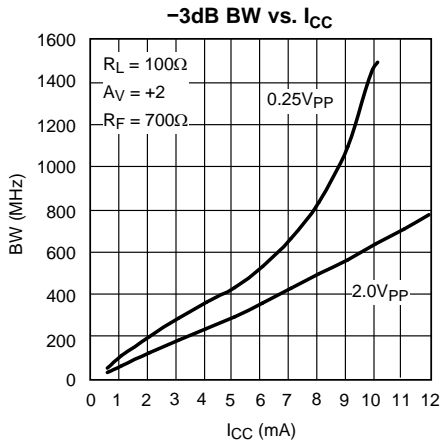

Figure 50.

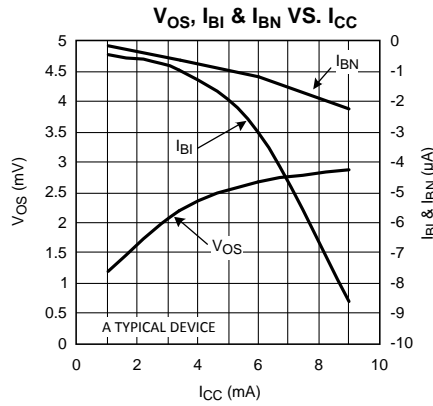

Figure 51.

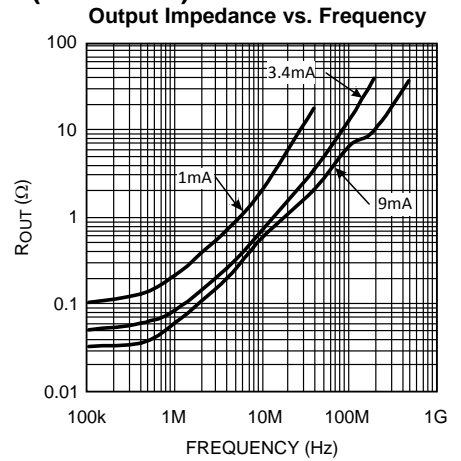

Figure 52.

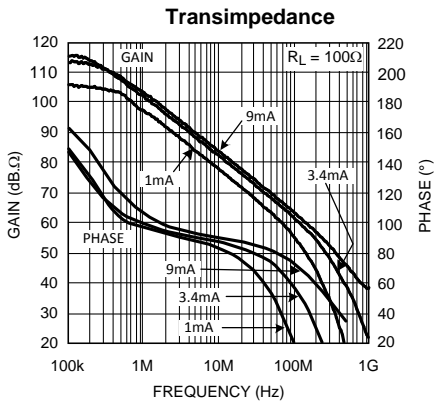

Figure 53.

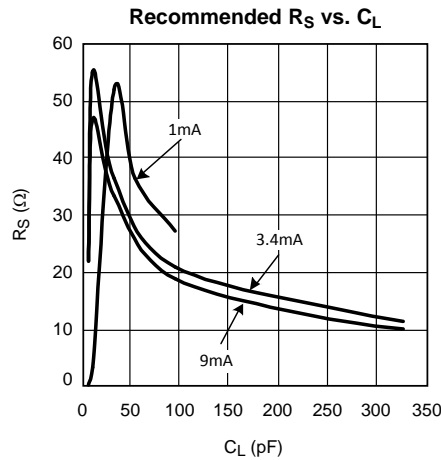

Figure 54.

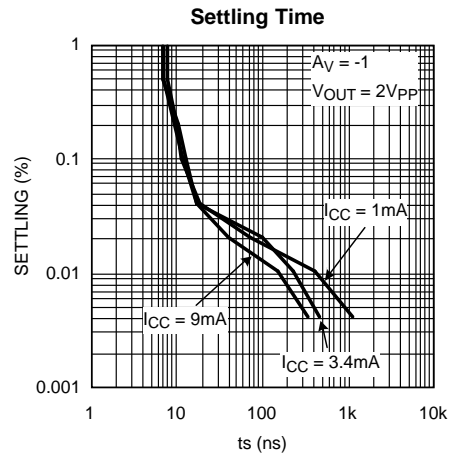

Figure 55.

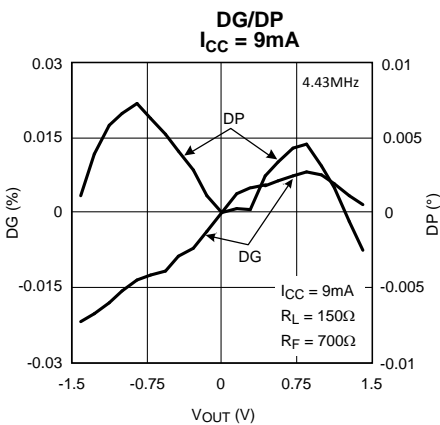

Figure 56.

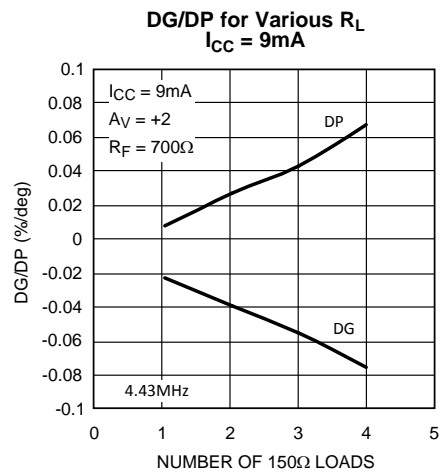

Figure 57.

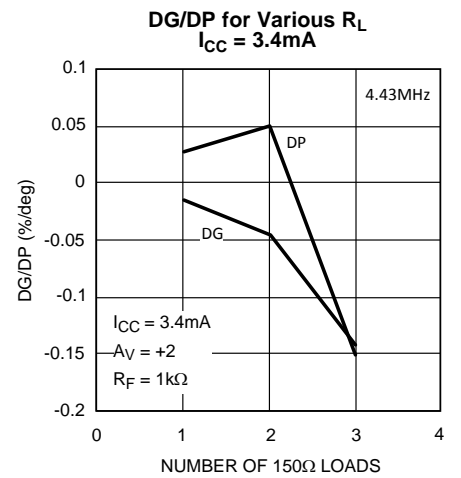

Figure 58.

## APPLICATION INFORMATION

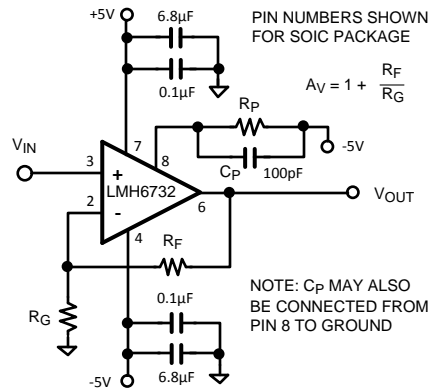

Figure 59. Recommended Non-Inverting Gain Circuit

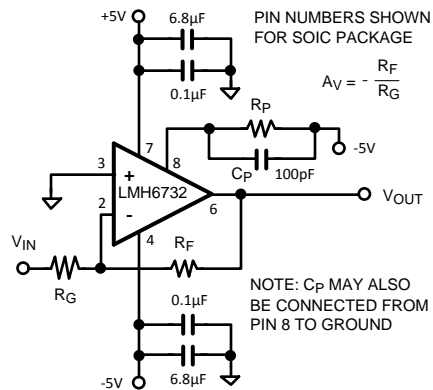

Figure 60. Recommended Inverting Gain Circuit

## DESCRIPTION

The LMH6732 is an adjustable supply current, current-feedback operational amplifier. Supply current and consequently dynamic performance can be easily adjusted by selecting the value of a single external resistor ( $R_P$ ).

### NOTE

The following discussion uses the SOIC package pin numbers. For the corresponding SOT-23 package pin numbers, please refer to the [Connection Diagrams](#) section.

## SELECTING AN OPERATING POINT

The operating point is determined by the supply current which in turn is determined by current ( $I_P$ ) flowing out of pin 8. As the supply current is increased, the following effects will be observed:

**Table 1. Device Parameters Related to Supply Current**

Specification	Effect as $I_{CC}$ Increases
Bandwidth	Increases
Rise Time	Decreases
Enable/ Disable Speed	Increases
Output Drive	Increases
Input Bias Current	Increases
Input Impedance	Decreases (see Source impedance Discussion)

Both the Electrical Characteristics pages and the [TYPICAL PERFORMANCE CHARACTERISTICS](#) section illustrate these effects to help make the supply current vs. performance trade-off. The supply current is adjustable over a continuous range of more than 10 to 1 with a single resistor,  $R_P$ , allowing for easy trade-off between power consumption and speed. Performance is specified and tested at  $I_{CC} = 1\text{mA}$ ,  $3.4\text{mA}$ , and  $9\text{mA}$ . (Note: Some test conditions and especially the load resistances are different for the three supply current settings.) The performance plots show typical performance for all three supply currents levels.

When making the supply current vs. performance trade-off, it is first a good idea to see if one of the standard operating points ( $I_{CC} = 1\text{mA}$ ,  $3.4\text{mA}$ , or  $9\text{mA}$ ) fits the application. If it does, performance ensured on the specification pages will apply directly to your application. In addition, the value of  $R_P$  may be obtained directly from the Electrical Characteristics pages.

### BEYOND 1GHz BANDWIDTH

As stated above, the LMH6732 speed can be increased by increasing the supply current. The  $-3\text{dB}$  Bandwidth can even reach the unprecedented value of  $1.5\text{GHz}$  ( $A_V = +2$ ,  $V_{OUT} = 0.25V_{PP}$ ). Of course, this comes at the expense of power consumption (i.e. supply current). The relationship between  $-3\text{dB}$  BW and supply current is shown in [Figure 48](#) to [Figure 50](#). The supply current would nominally have to be set to around  $10\text{mA}$  to achieve this speed. The absolute maximum supply current setting for the LMH6732 is  $14\text{mA}$ . Beyond this value, the operation may become unpredictable.

**The following discussion will assist in selecting  $I_{CC}$  for applications that cannot operate at one of the specified supply current settings.**

Use the typical performance plots for critical specifications to select the best  $I_{CC}$ . For parameters containing Min/Max ratings in the data sheet tables, interpolate between the values of  $I_{CC}$  in the plots & specification tables to estimate the max/min values in the application.

The simplified schematic for the supply current setting path ( $I_P$ ) is shown below in [Figure 61](#).

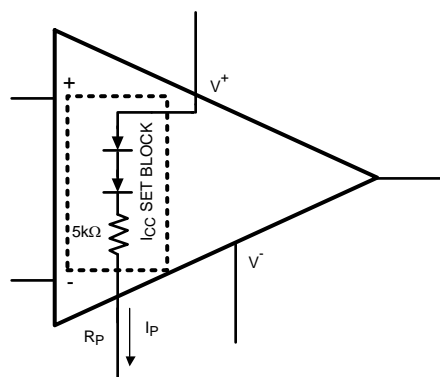

**Figure 61. Supply Current Control's Simplified Schematic**

The terminal marked " $R_P$ " is tied to a potential through a resistor  $R_P$ . The current flowing through  $R_P$  ( $I_P$ ) sets the LMH6732's supply current. Throughout the data sheet, the voltages applied to  $R_P$  and  $V^-$  are both considered to be  $-5\text{V}$ . However, the two potentials do not necessarily have to be the same. This is beneficial in applications where non-standard supply voltages are used or when there is a need to power down the op amp via digital logic control.

The relationship between  $I_{CC}$  and  $I_P$  is given by:

$I_P = I_{CC}/57$  (approximate ratio at  $I_{CC} = 3.4\text{mA}$ ; consult [Figure 45](#) for relationship at any  $I_{CC}$ ).

Knowing  $I_P$  leads to a direct calculation of  $R_P$ .

$$R_P + 5\text{k}\Omega = [(V^+ - 1.6) - V^-] / I_P$$

$$R_P + 5\text{k}\Omega = 8.4 / I_P \text{ (for } V^+ = 5\text{V and } V^- = -5\text{V).}$$

First, an operating point needs to be determined from the plots & specifications as discussed above. From this,  $I_P$  is obtained. Knowing  $I_P$  and the potential  $R_P$  is tied to,  $R_P$  can be calculated.

### EXAMPLE

An application requires that  $V_S = \pm 3\text{V}$  and performance in the 1mA operating point range. The required  $I_P$  can therefore be determined as follows:

$$I_P = 21\mu\text{A}$$

$R_P$  is connected from pin 8 to  $V^-$ . Calculate  $R_P$  under these conditions:

$$R_P + 5\text{k}\Omega = [(V^+ - 1.6) - V^-] / I_P$$

$$R_P + 5\text{k}\Omega = [(3\text{V} - 1.6\text{V}) - (-3\text{V})] / 21\mu\text{A}$$

$$R_P = 205\text{k}\Omega$$

The LMH6732 will have performance similar to  $R_P = 412\text{k}\Omega$  shown on the datasheet, but with 40% less power dissipation due to the reduced supply voltages. The op amp will also have a more restricted common-mode range and output swing.

### DYNAMIC SHUTDOWN CAPABILITY

The LMH6732 may be powered on and off very quickly by controlling the voltage applied to  $R_P$ . If  $R_P$  is connected between pin 8 and the output of a CMOS gate powered from  $\pm 5\text{V}$  supplies, the gate can be used to turn the amplifier on and off. This is shown in [Figure 62](#) below:

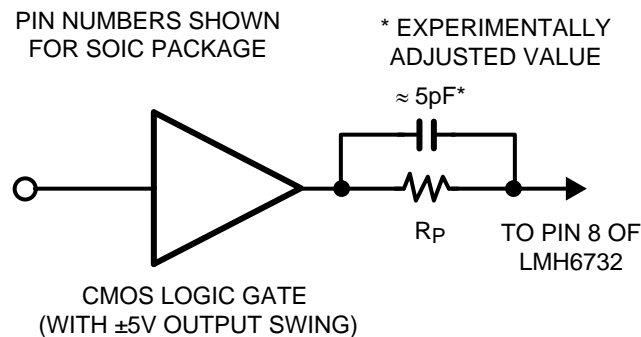

**Figure 62. Dynamic Control of Power Consumption Using CMOS Logic**

When the gate output is switched from high to low, the LMH6732 will turn on. In the off state, the supply current typically reduces to  $1\mu\text{A}$  or less. The LMH6732's "off state" supply current is reduced significantly compared to the CLC505. This extremely low supply current in the "off state" is quite advantageous since it allows for significant power saving and minimizes feed-through. To improve switching time, a speed up capacitor from the gate output to pin 8 is recommended. The value of this capacitor will depend on the  $R_P$  value used and is best established experimentally. Turn-on and turn-off times of  $<20\text{ns}$  ( $I_{CC} = 9\text{mA}$ ) are achievable with ordinary CMOS gates.

### EXAMPLE

An open collector logic device is used to dynamically control the power dissipation of the circuit. Here, the desired connection for  $R_P$  is from pin 8 to the open collector logic device.

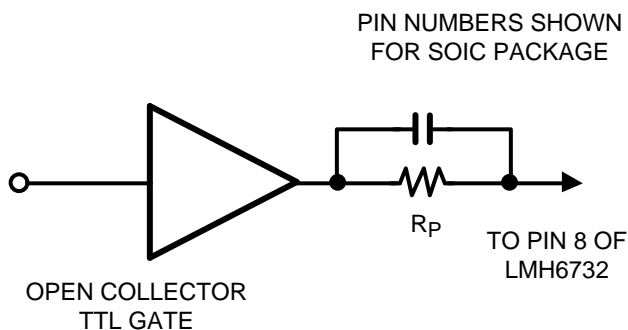

Figure 63. Controlling Power On State with TTL Logic (Open Collector Output)

When the logic gate goes low, the LMH6732 is turned on. The LMH6732 V<sup>+</sup> connection would be to +5V supply. Performance desired is that given for I<sub>CC</sub> = 3.4mA under standard conditions. From the I<sub>CC</sub> vs. I<sub>P</sub> plot, I<sub>P</sub> = 61μA. Then calculating R<sub>P</sub>:

$$R_P + 5k\Omega = [(5V - 1.6V) - 0] / 61\mu A$$

$$R_P = 51k\Omega$$

### "POPLESS OUTPUT" & OFF CONDITION OUTPUT STATE

The LMH6732 has been especially designed to have minimum glitches during turn-on and turn-off. This is advantageous in situations where the LMH6732 output is fed to another stage which could experience false auto-ranging, or even worse reset operation, due to these transient glitches. Example of this application would be an AGC circuit or an ADC with multiple ranges set to accommodate the largest input amplitude. For the LMH6732, these sorts of transients are typically less than 50mV in amplitude (see Electrical Characteristics Tables for Typical values). Applications designed to utilize the CLC505's low output glitch would benefit from using the LMH6732 instead since the LMH6732's output glitch is improved to be even lower than the CLC505's. In the "Off State", the output stage is turned off and is in effect put into a high-Z state. In this state, output can be forced by other active devices. No significant current will flow through the device output pin in this mode of operation.

### MUX APPLICATION

Since The LMH6732's output is essentially open in the "off" state, it is a good candidate for a fast 2:1 MUX. Figure 64 shows one such application along with the output waveform in Figure 65 displaying the switching between a continuous triangle wave and a single cycle sine wave (signals trigger locked to each other for stable scope photo). Switching speed of the MUX will be less than 50 ns and is governed by the "Ton" and "Toff" times for U1 and U2 at the supply current set by R<sub>P1</sub> and R<sub>P2</sub>. Note that the "Control" input is a 5V CMOS logic level.

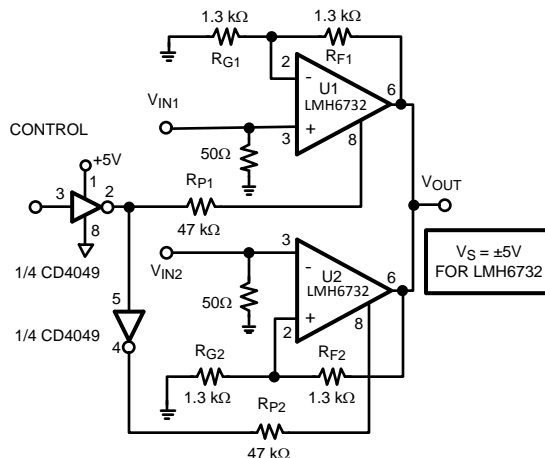
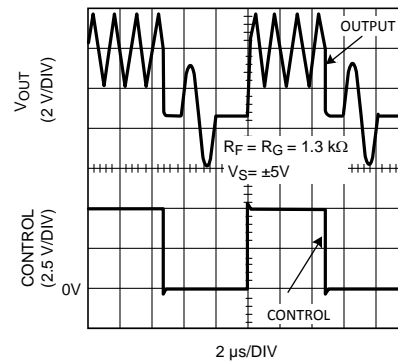

Figure 64. 50 ns 2:1 MUX Schematic



**Figure 65. MUX “V<sub>OUT</sub>” and “Control” Waveform**

## DIFFERENTIAL GAIN AND PHASE

Differential gain and phase are measurements useful primarily in composite video channels. They are measured by monitoring the gain and phase changes of a high frequency carrier (3.58MHz for NTSC and 4.43MHz for PAL systems) as the output of the amplifier is swept over a range of DC voltages. Specifications for the LMH6732 include differential gain and phase. Test signals used are based on a 1V<sub>PP</sub> video level. Test conditions used are the following:

DC sweep range: 0 to 100 IRE units (black to white)

Carrier: 4.43MHz at 40 IRE units peak to peak

$A_V = +2$ ,  $R_L = 75\Omega + 75\Omega$

## SOURCE IMPEDANCE

For best results, source impedance in the non-inverting circuit configuration (see [Figure 59](#)) should be kept below 5k $\Omega$ .

Above 5k $\Omega$  it is possible for oscillation to occur, depending on other circuit board parasitics. For high signal source impedances, a resistor with a value of less than 5k $\Omega$  may be used to terminate the non-inverting input to ground.

## FEEDBACK RESISTOR

In current-feedback op amps, the value of the feedback resistor plays a major role in determining amplifier dynamics. It is important to select the correct value. The LMH6732 provides optimum performance with feedback resistors as shown in [Table 2](#) below. Selection of an incorrect value can lead to severe roll-off in frequency response, (if the resistor value is too large) or , peaking or oscillation (if the value is too low).

**Table 2. Feedback Resistor Selection for Various Gain Settings and I<sub>CC</sub>'s**

Gain (V/V)	I <sub>CC</sub> (mA)			Unit
	9	3.4	1	
A <sub>V</sub> = +1	700	1k	1k	$\Omega$
A <sub>V</sub> = +2	700	1k	1k	$\Omega$
A <sub>V</sub> = -1	500	750	1k	$\Omega$
A <sub>V</sub> = -2	400	450	1k	$\Omega$
A <sub>V</sub> = +6	500	500	1k	$\Omega$
A <sub>V</sub> = -6	200	200	1k	$\Omega$
A <sub>V</sub> = +21	1k	1k	1k	$\Omega$
A <sub>V</sub> = -20	500	500	1k	$\Omega$

For  $I_{CC} > 9\text{mA}$  at any closed loop gain setting, a good starting point for  $R_F$  would be the 9mA value stated in [Table 2](#) above. This value could then be readjusted, if necessary, to achieve the desired response.

## PRINTED CIRCUIT LAYOUT & EVALUATION BOARDS

Generally, a good high frequency layout will keep power supply and ground traces away from the inverting input and output pins. Parasitic capacitances on these nodes to ground will cause frequency response peaking and possible circuit oscillations (see Application Note OA-15 ([SNOA367](#)) for more information).

Use the following evaluation boards as a guide for high frequency layout and as an aid in device testing and characterization:

Device	Package	Evaluation Board Part Number
LMH6732MF	SOT-23	LMH730216
LMH6732MA	SOIC	LMH730227

The supply current adjustment resistor,  $R_P$ , in both evaluation boards should be tied to the appropriate potential to get the desired supply current. To do so, leave R2 (LMH730216) [ R5 (LMH730227) ] uninstalled. Jumper "Dis" connector to V-. Install R1 (LMH730216) [ R4 (LMH730227) ] to set the supply current.

## REVISION HISTORY

Changes from Revision A (March 2013) to Revision B	Page
• Changed layout of National Data Sheet to TI format .....	<a href="#">21</a>

**PACKAGING INFORMATION**

Orderable Device	Status (1)	Package Type	Package Drawing	Pins	Package Qty	Eco Plan (2)	Lead/Ball Finish (6)	MSL Peak Temp (3)	Op Temp (°C)	Device Marking (4/5)	Samples
LMH6732MA/NOPB	ACTIVE	SOIC	D	8	95	Green (RoHS & no Sb/Br)	CU SN	Level-1-260C-UNLIM	-40 to 85	LMH6732MA	<a href="#">Samples</a>
LMH6732MAX/NOPB	ACTIVE	SOIC	D	8	2500	Green (RoHS & no Sb/Br)	CU SN	Level-1-260C-UNLIM	-40 to 85	LMH6732MA	<a href="#">Samples</a>
LMH6732MF/NOPB	ACTIVE	SOT-23	DBV	6	1000	Green (RoHS & no Sb/Br)	CU SN	Level-1-260C-UNLIM	-40 to 85	A97A	<a href="#">Samples</a>
LMH6732MFX/NOPB	ACTIVE	SOT-23	DBV	6	3000	Green (RoHS & no Sb/Br)	CU SN	Level-1-260C-UNLIM	-40 to 85	A97A	<a href="#">Samples</a>

(1) The marketing status values are defined as follows:

**ACTIVE:** Product device recommended for new designs.

**LIFEBUY:** TI has announced that the device will be discontinued, and a lifetime-buy period is in effect.

**NRND:** Not recommended for new designs. Device is in production to support existing customers, but TI does not recommend using this part in a new design.

**PREVIEW:** Device has been announced but is not in production. Samples may or may not be available.

**OBSELETE:** TI has discontinued the production of the device.

(2) Eco Plan - The planned eco-friendly classification: Pb-Free (RoHS), Pb-Free (RoHS Exempt), or Green (RoHS & no Sb/Br) - please check <http://www.ti.com/productcontent> for the latest availability information and additional product content details.

**TBD:** The Pb-Free/Green conversion plan has not been defined.

**Pb-Free (RoHS):** TI's terms "Lead-Free" or "Pb-Free" mean semiconductor products that are compatible with the current RoHS requirements for all 6 substances, including the requirement that lead not exceed 0.1% by weight in homogeneous materials. Where designed to be soldered at high temperatures, TI Pb-Free products are suitable for use in specified lead-free processes.

**Pb-Free (RoHS Exempt):** This component has a RoHS exemption for either 1) lead-based flip-chip solder bumps used between the die and package, or 2) lead-based die adhesive used between the die and leadframe. The component is otherwise considered Pb-Free (RoHS compatible) as defined above.

**Green (RoHS & no Sb/Br):** TI defines "Green" to mean Pb-Free (RoHS compatible), and free of Bromine (Br) and Antimony (Sb) based flame retardants (Br or Sb do not exceed 0.1% by weight in homogeneous material)

(3) MSL, Peak Temp. - The Moisture Sensitivity Level rating according to the JEDEC industry standard classifications, and peak solder temperature.

(4) There may be additional marking, which relates to the logo, the lot trace code information, or the environmental category on the device.

(5) Multiple Device Markings will be inside parentheses. Only one Device Marking contained in parentheses and separated by a "~" will appear on a device. If a line is indented then it is a continuation of the previous line and the two combined represent the entire Device Marking for that device.

(6) Lead/Ball Finish - Orderable Devices may have multiple material finish options. Finish options are separated by a vertical ruled line. Lead/Ball Finish values may wrap to two lines if the finish value exceeds the maximum column width.

**Important Information and Disclaimer:** The information provided on this page represents TI's knowledge and belief as of the date that it is provided. TI bases its knowledge and belief on information provided by third parties, and makes no representation or warranty as to the accuracy of such information. Efforts are underway to better integrate information from third parties. TI has taken and continues to take reasonable steps to provide representative and accurate information but may not have conducted destructive testing or chemical analysis on incoming materials and chemicals. TI and TI suppliers consider certain information to be proprietary, and thus CAS numbers and other limited information may not be available for release.

In no event shall TI's liability arising out of such information exceed the total purchase price of the TI part(s) at issue in this document sold by TI to Customer on an annual basis.

## TAPE AND REEL INFORMATION



### QUADRANT ASSIGNMENTS FOR PIN 1 ORIENTATION IN TAPE



\*All dimensions are nominal

Device	Package Type	Package Drawing	Pins	SPQ	Reel Diameter (mm)	Reel Width W1 (mm)	A0 (mm)	B0 (mm)	K0 (mm)	P1 (mm)	W (mm)	Pin1 Quadrant
LMH6732MAX/NOPB	SOIC	D	8	2500	330.0	12.4	6.5	5.4	2.0	8.0	12.0	Q1
LMH6732MF/NOPB	SOT-23	DBV	6	1000	178.0	8.4	3.2	3.2	1.4	4.0	8.0	Q3
LMH6732MFX/NOPB	SOT-23	DBV	6	3000	178.0	8.4	3.2	3.2	1.4	4.0	8.0	Q3

**TAPE AND REEL BOX DIMENSIONS**



\*All dimensions are nominal

Device	Package Type	Package Drawing	Pins	SPQ	Length (mm)	Width (mm)	Height (mm)
LMH6732MAX/NOPB	SOIC	D	8	2500	367.0	367.0	35.0
LMH6732MF/NOPB	SOT-23	DBV	6	1000	210.0	185.0	35.0
LMH6732MFX/NOPB	SOT-23	DBV	6	3000	210.0	185.0	35.0

# MECHANICAL DATA

DBV (R-PDSO-G6)

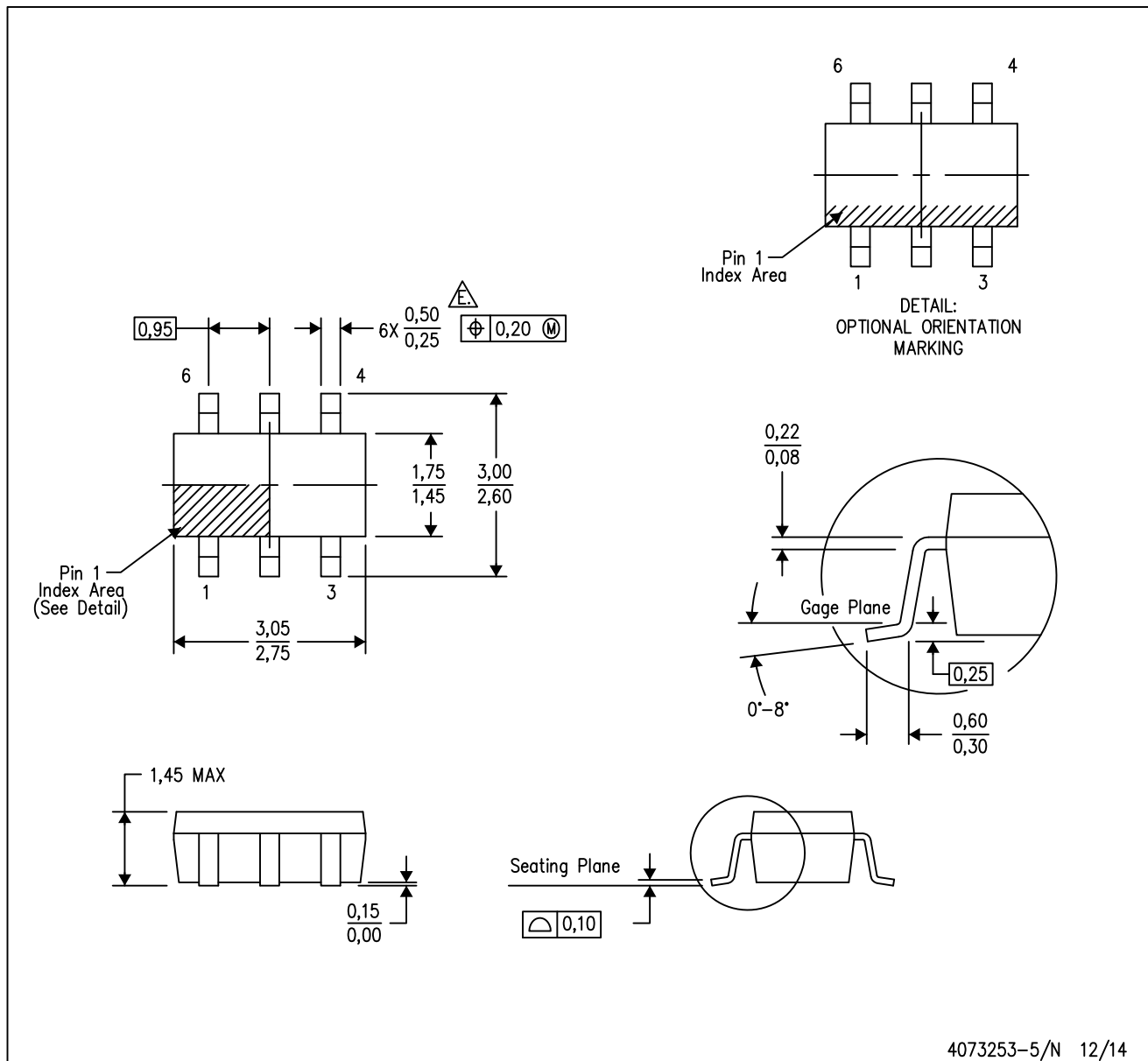
PLASTIC SMALL-OUTLINE PACKAGE



- NOTES:
- A. All linear dimensions are in millimeters.
  - B. This drawing is subject to change without notice.
  - C. Body dimensions do not include mold flash or protrusion. Mold flash and protrusion shall not exceed 0.15 per side.
  - D. Leads 1,2,3 may be wider than leads 4,5,6 for package orientation.
- ⚠ Falls within JEDEC MO-178 Variation AB, except minimum lead width.

D (R-PDSO-G8)

PLASTIC SMALL OUTLINE

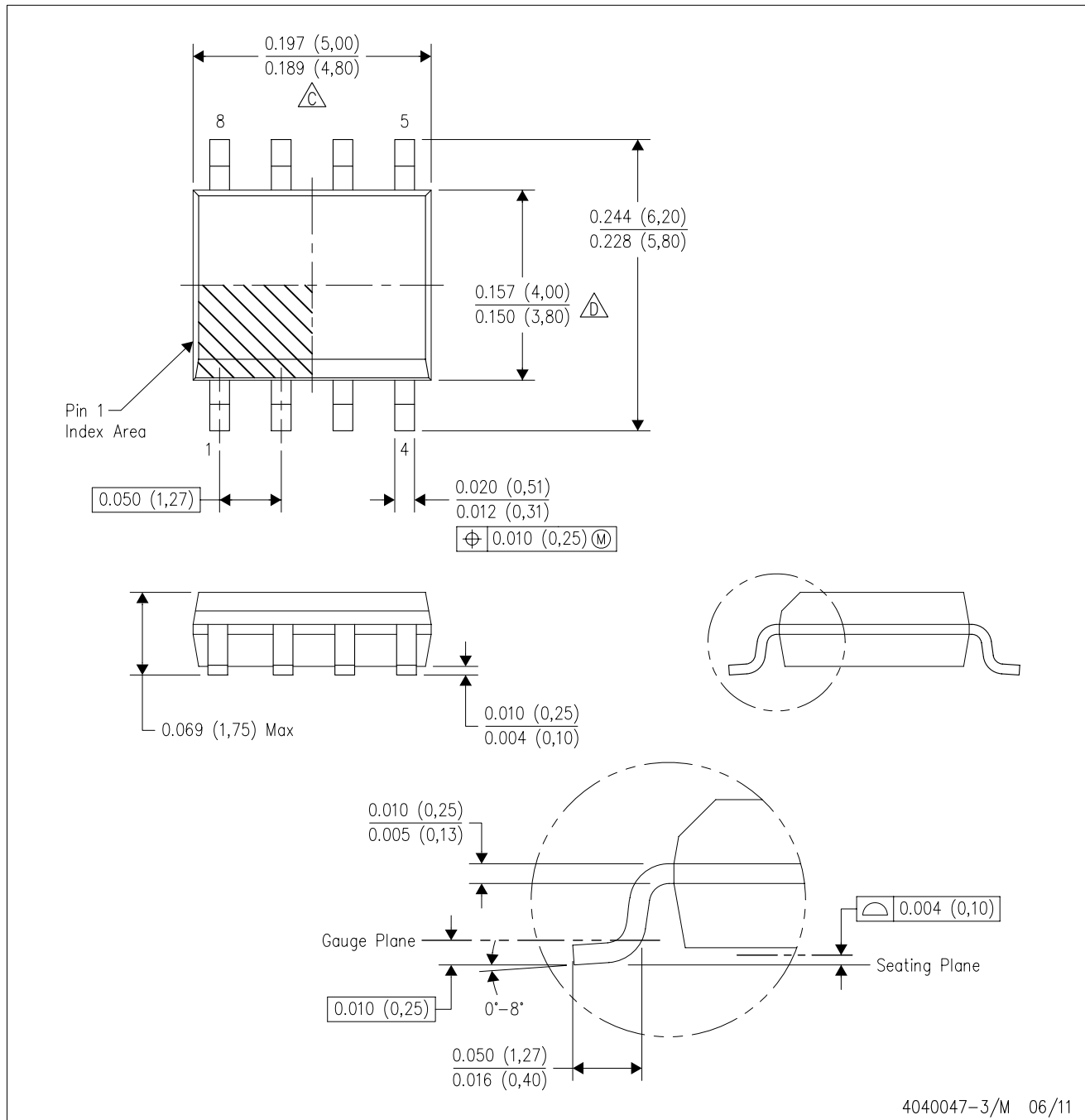

- NOTES:
- A. All linear dimensions are in inches (millimeters).
  - B. This drawing is subject to change without notice.
  - Body length does not include mold flash, protrusions, or gate burrs. Mold flash, protrusions, or gate burrs shall not exceed 0.006 (0,15) each side.
  - Body width does not include interlead flash. Interlead flash shall not exceed 0.017 (0,43) each side.
  - E. Reference JEDEC MS-012 variation AA.

## IMPORTANT NOTICE

Texas Instruments Incorporated and its subsidiaries (TI) reserve the right to make corrections, enhancements, improvements and other changes to its semiconductor products and services per JESD46, latest issue, and to discontinue any product or service per JESD48, latest issue. Buyers should obtain the latest relevant information before placing orders and should verify that such information is current and complete. All semiconductor products (also referred to herein as "components") are sold subject to TI's terms and conditions of sale supplied at the time of order acknowledgment.

TI warrants performance of its components to the specifications applicable at the time of sale, in accordance with the warranty in TI's terms and conditions of sale of semiconductor products. Testing and other quality control techniques are used to the extent TI deems necessary to support this warranty. Except where mandated by applicable law, testing of all parameters of each component is not necessarily performed.

TI assumes no liability for applications assistance or the design of Buyers' products. Buyers are responsible for their products and applications using TI components. To minimize the risks associated with Buyers' products and applications, Buyers should provide adequate design and operating safeguards.

TI does not warrant or represent that any license, either express or implied, is granted under any patent right, copyright, mask work right, or other intellectual property right relating to any combination, machine, or process in which TI components or services are used. Information published by TI regarding third-party products or services does not constitute a license to use such products or services or a warranty or endorsement thereof. Use of such information may require a license from a third party under the patents or other intellectual property of the third party, or a license from TI under the patents or other intellectual property of TI.

Reproduction of significant portions of TI information in TI data books or data sheets is permissible only if reproduction is without alteration and is accompanied by all associated warranties, conditions, limitations, and notices. TI is not responsible or liable for such altered documentation. Information of third parties may be subject to additional restrictions.

Resale of TI components or services with statements different from or beyond the parameters stated by TI for that component or service voids all express and any implied warranties for the associated TI component or service and is an unfair and deceptive business practice. TI is not responsible or liable for any such statements.

Buyer acknowledges and agrees that it is solely responsible for compliance with all legal, regulatory and safety-related requirements concerning its products, and any use of TI components in its applications, notwithstanding any applications-related information or support that may be provided by TI. Buyer represents and agrees that it has all the necessary expertise to create and implement safeguards which anticipate dangerous consequences of failures, monitor failures and their consequences, lessen the likelihood of failures that might cause harm and take appropriate remedial actions. Buyer will fully indemnify TI and its representatives against any damages arising out of the use of any TI components in safety-critical applications.

In some cases, TI components may be promoted specifically to facilitate safety-related applications. With such components, TI's goal is to help enable customers to design and create their own end-product solutions that meet applicable functional safety standards and requirements. Nonetheless, such components are subject to these terms.

No TI components are authorized for use in FDA Class III (or similar life-critical medical equipment) unless authorized officers of the parties have executed a special agreement specifically governing such use.

Only those TI components which TI has specifically designated as military grade or "enhanced plastic" are designed and intended for use in military/aerospace applications or environments. Buyer acknowledges and agrees that any military or aerospace use of TI components which have **not** been so designated is solely at the Buyer's risk, and that Buyer is solely responsible for compliance with all legal and regulatory requirements in connection with such use.

TI has specifically designated certain components as meeting ISO/TS16949 requirements, mainly for automotive use. In any case of use of non-designated products, TI will not be responsible for any failure to meet ISO/TS16949.

### Products

Audio	<a href="http://www.ti.com/audio">www.ti.com/audio</a>
Amplifiers	<a href="http://amplifier.ti.com">amplifier.ti.com</a>
Data Converters	<a href="http://dataconverter.ti.com">dataconverter.ti.com</a>
DLP® Products	<a href="http://www.dlp.com">www.dlp.com</a>
DSP	<a href="http://dsp.ti.com">dsp.ti.com</a>
Clocks and Timers	<a href="http://www.ti.com/clocks">www.ti.com/clocks</a>
Interface	<a href="http://interface.ti.com">interface.ti.com</a>
Logic	<a href="http://logic.ti.com">logic.ti.com</a>
Power Mgmt	<a href="http://power.ti.com">power.ti.com</a>
Microcontrollers	<a href="http://microcontroller.ti.com">microcontroller.ti.com</a>
RFID	<a href="http://www.ti-rfid.com">www.ti-rfid.com</a>
OMAP Applications Processors	<a href="http://www.ti.com/omap">www.ti.com/omap</a>
Wireless Connectivity	<a href="http://www.ti.com/wirelessconnectivity">www.ti.com/wirelessconnectivity</a>

### Applications

Automotive and Transportation	<a href="http://www.ti.com/automotive">www.ti.com/automotive</a>
Communications and Telecom	<a href="http://www.ti.com/communications">www.ti.com/communications</a>
Computers and Peripherals	<a href="http://www.ti.com/computers">www.ti.com/computers</a>
Consumer Electronics	<a href="http://www.ti.com/consumer-apps">www.ti.com/consumer-apps</a>
Energy and Lighting	<a href="http://www.ti.com/energy">www.ti.com/energy</a>
Industrial	<a href="http://www.ti.com/industrial">www.ti.com/industrial</a>
Medical	<a href="http://www.ti.com/medical">www.ti.com/medical</a>
Security	<a href="http://www.ti.com/security">www.ti.com/security</a>
Space, Avionics and Defense	<a href="http://www.ti.com/space-avionics-defense">www.ti.com/space-avionics-defense</a>
Video and Imaging	<a href="http://www.ti.com/video">www.ti.com/video</a>

### TI E2E Community

[e2e.ti.com](http://e2e.ti.com)