

LOW-VOLTAGE RAIL-TO-RAIL OUTPUT OPERATIONAL AMPLIFIERS

Check for Samples: [LMV821-Q1](#), [LMV822-Q1](#), [LMV824-Q1](#)

FEATURES

- Qualified for Automotive Applications
- 2.5-V, 2.7-V, and 5-V Performance
- –40°C to 125°C Operation
- No Crossover Distortion
- Low Supply Current at $V_{CC+} = 5\text{ V}$
 - LMV821: 0.3 mA Typ
 - LMV822: 0.5 mA Typ
 - LMV824: 1 mA Typ
- Rail-to-Rail Output Swing
- Gain Bandwidth of 5.5 MHz Typ at 5 V
- Slew Rate of 1.9 V/ μs Typ at 5 V

The LMV82x devices are characterized for operation from –40°C to 125°C.

LMV821...DBV PACKAGE
(TOP VIEW)

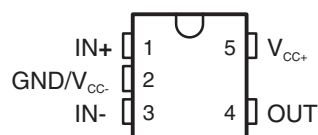

LMV822...DGK PACKAGE
(TOP VIEW)

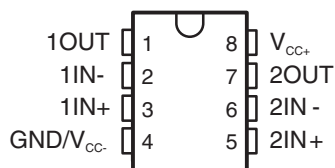

LMV824...D OR PW PACKAGE
(TOP VIEW)

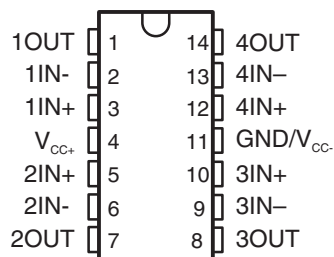

DESCRIPTION/ORDERING INFORMATION

The LMV821 single, LMV822 dual, and LMV824 quad devices are low-voltage (2.5 V to 5.5 V), low-power commodity operational amplifiers. Electrical characteristics are very similar to the LMV3xx operational amplifiers (low supply current, rail-to-rail outputs, input common-mode range that includes ground). However, the LMV82x devices offer a higher bandwidth (5.5 MHz typical) and faster slew rate (1.9 V/ μs typical).

The LMV82x devices are cost-effective solutions for applications requiring low-voltage/low-power operation and space-saving considerations. The LMV821 saves space on printed circuit boards and enables the design of small portable electronic devices (cordless and cellular phones, laptops, PDAs, PCMIA). It also allows the designer to place the device closer to the signal source to reduce noise pickup and increase signal integrity.

ORDERING INFORMATION⁽¹⁾

T_A	PACKAGE ⁽²⁾		ORDERABLE PART NUMBER	TOP-SIDE MARKING ⁽³⁾	
–40°C to 125°C	Single	SOT-23 – DBV	Reel of 3000	LMV821QDBVRQ1	RB1_
	Dual	MSOP/VSSOP – DGK	Reel of 2500	LMV822QDGKRQ1	R8B
	Quad	SOIC – D	Reel of 2500	LMV824QDRQ1	LMV824Q
		TSSOP – PW	Reel of 2000	LMV824QPWRQ1	MV824Q

(1) For the most current package and ordering information, see the Package Option Addendum at the end of this document, or see the TI web site at www.ti.com.

(2) Package drawings, thermal data, and symbolization are available at www.ti.com/packaging.

(3) DBV: The actual top-side marking has one additional character that designates the wafer fab/assembly site.



Please be aware that an important notice concerning availability, standard warranty, and use in critical applications of Texas Instruments semiconductor products and disclaimers thereto appears at the end of this data sheet.

SYMBOL (EACH AMPLIFIER)

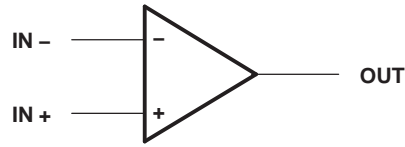

SIMPLIFIED SCHEMATIC

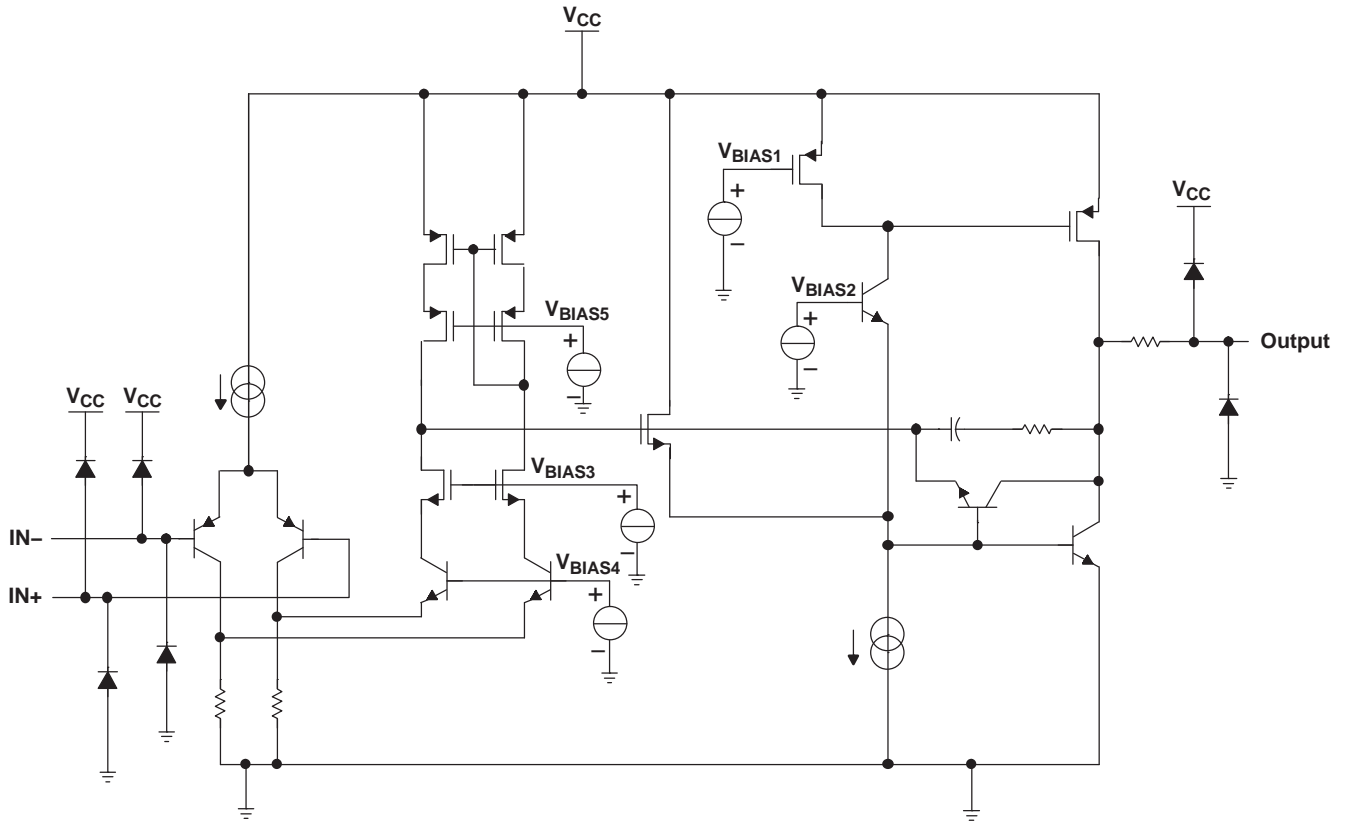

ABSOLUTE MAXIMUM RATINGS⁽¹⁾

over operating free-air temperature range (unless otherwise noted)

V_{CC}	Supply voltage ⁽²⁾		5.5 V
V_{ID}	Differential input voltage ⁽³⁾		$\pm V_{CC}$
V_I	Input voltage range (either input)		V_{CC-} to V_{CC+}
	Duration of output short circuit (one amplifier) to ground ⁽⁴⁾	At or below $T_A = 25^\circ\text{C}$, $V_{CC} \leq 5.5\text{ V}$	Unlimited
θ_{JA}	Package thermal impedance ⁽⁵⁾ (6)	D package	97°C/W
		DBV package	206°C/W
		DGK package	172°C/W
		PW package	113°C/W
T_J	Operating virtual-junction temperature		150°C
T_{stg}	Storage temperature range		-65°C to 150°C

- (1) Stresses beyond those listed under *absolute maximum ratings* may cause permanent damage to the device. These are stress ratings only, and functional operation of the device at these or any other conditions beyond those indicated under *recommended operating conditions* is not implied. Exposure to absolute-maximum-rated conditions for extended periods may affect device reliability.
- (2) All voltage values (except differential voltages and V_{CC} specified for the measurement of I_{OS}) are with respect to the network GND.
- (3) Differential voltages are at IN+ with respect to IN-.
- (4) Short circuits from outputs to V_{CC} can cause excessive heating and eventual destruction.
- (5) Maximum power dissipation is a function of $T_J(\text{max})$, θ_{JA} , and T_A . The maximum allowable power dissipation at any allowable ambient temperature is $P_D = (T_J(\text{max}) - T_A)/\theta_{JA}$. Operating at the absolute maximum T_J of 150°C can affect reliability.
- (6) The package thermal impedance is calculated in accordance with JESD 51-7.

RECOMMENDED OPERATING CONDITIONS

	MIN	MAX	UNIT
V_{CC} Supply voltage (single-supply operation)	2.5	5	V
T_A Operating free-air temperature	-40	125	°C

2.5-V ELECTRICAL CHARACTERISTICS

 $V_{CC+} = 2.5\text{ V}$, $V_{CC-} = 0\text{ V}$, $V_{IC} = 1\text{ V}$, $V_O = 1.25\text{ V}$, and $R_L > 1\text{ M}\Omega$ (unless otherwise noted)

PARAMETER	TEST CONDITIONS	T_A	MIN	TYP	MAX	UNIT	
V_{IO} Input offset voltage		25°C		1	6	mV	
		-40°C to 125°C			6		
V_O Output swing	$V_{CC+} = 2.5\text{ V}$, $R_L = 600\ \Omega$ to 1.25 V	High level	25°C	2.28	2.37	V	
			-40°C to 125°C	2.18			
		Low level	25°C		0.13		0.22
			-40°C to 125°C				0.32
	$V_{CC+} = 2.5\text{ V}$, $R_L = 2\text{ k}\Omega$ to 1.25 V	High level	25°C	2.38	2.46		
			-40°C to 125°C	2.28			
		Low level	25°C		0.08		0.14
			-40°C to 125°C				0.22

2.7-V ELECTRICAL CHARACTERISTICS

$V_{CC+} = 2.7\text{ V}$, $V_{CC-} = 0\text{ V}$, $V_{IC} = 1\text{ V}$, $V_O = 1.35\text{ V}$, and $R_L > 1\text{ M}\Omega$ (unless otherwise noted)

PARAMETER		TEST CONDITIONS		T_A	MIN	TYP	MAX	UNIT
V_{IO}	Input offset voltage			25°C		1	6	mV
				-40°C to 125°C			6	
α_{VIO}	Average temperature coefficient of input offset voltage			25°C		1		$\mu\text{V}/^\circ\text{C}$
I_{IB}	Input bias current			25°C		30	90	nA
				-40°C to 125°C			140	
I_{IO}	Input offset current			25°C		0.5	30	nA
				-40°C to 125°C			50	
CMRR	Common-mode rejection ratio	$V_{IC} = 0\text{ to }1.7\text{ V}$		25°C	70	85		dB
				-40°C to 125°C	68			
$+k_{SVR}$	Positive supply-voltage rejection ratio	$V_{CC+} = 1.7\text{ V to }4\text{ V}$, $V_{CC-} = -1\text{ V}$, $V_O = 0$, $V_{IC} = 0$		25°C	75	85		dB
				-40°C to 125°C	70			
$-k_{SVR}$	Negative supply-voltage rejection ratio	$V_{CC+} = 1.7\text{ V}$, $V_{CC-} = -1\text{ V to }-3.3\text{ V}$, $V_O = 0$, $V_{IC} = 0$		25°C	73	85		dB
				-40°C to 125°C	70			
V_{ICR}	Common-mode input voltage range	CMRR $\geq 50\text{ dB}$		25°C	-0.2 to 1.9	-0.3 to 2		V
A_V	Large-signal voltage amplification	$R_L = 600\ \Omega\text{ to }1.35\text{ V}$, $V_O = 1.35\text{ V to }2.2\text{ V}$	Sourcing	25°C	90	100		dB
				-40°C to 125°C	85			
		$R_L = 600\ \Omega\text{ to }1.35\text{ V}$, $V_O = 1.35\text{ V to }0.5\text{ V}$	Sinking	25°C	85	90		
				-40°C to 125°C	80			
$R_L = 2\text{ k}\Omega\text{ to }1.35\text{ V}$, $V_O = 1.35\text{ V to }2.2\text{ V}$	Sourcing	25°C	95	100				
		-40°C to 125°C	90					
$R_L = 2\text{ k}\Omega\text{ to }1.35\text{ V}$, $V_O = 1.35\text{ V to }0.5\text{ V}$	Sinking	25°C	90	95				
		-40°C to 125°C	85					
V_O	Output swing	$V_{CC+} = 2.7\text{ V}$, $R_L = 600\ \Omega\text{ to }1.35\text{ V}$	High level	25°C	2.5	2.58		V
					-40°C to 125°C	2.4		
			Low level	25°C		0.13	0.2	
					-40°C to 125°C		0.3	
		$V_{CC+} = 2.7\text{ V}$, $R_L = 2\text{ k}\Omega\text{ to }1.35\text{ V}$	High level	25°C	2.6	2.66		
					-40°C to 125°C	2.5		
Low level	25°C		0.08	0.12				
		-40°C to 125°C		0.2				
I_O	Output current	$V_O = 0\text{ V}$	Sourcing	25°C	12	16		mA
		$V_O = 2.7\text{ V}$	Sinking	25°C	12	26		
I_{CC}	Supply current	LMV821		25°C		0.22	0.3	mA
					-40°C to 125°C			
		LMV822 (both amplifiers)		25°C		0.45	0.6	
					-40°C to 125°C			
		LMV824 (all four amplifiers)		25°C		0.72	1	
					-40°C to 125°C			

2.7-V ELECTRICAL CHARACTERISTICS (continued)
 $V_{CC+} = 2.7\text{ V}$, $V_{CC-} = 0\text{ V}$, $V_{IC} = 1\text{ V}$, $V_O = 1.35\text{ V}$, and $R_L > 1\text{ M}\Omega$ (unless otherwise noted)

PARAMETER		TEST CONDITIONS	T_A	MIN	TYP	MAX	UNIT
SR	Slew rate ⁽¹⁾		25°C		1.7		V/ μ s
GBW	Gain bandwidth product	⁽²⁾	25°C		5		MHz
Φ_m	Phase margin	⁽²⁾	25°C		60		deg
	Gain margin	⁽²⁾	25°C		8.6		dB
	Amplifier-to-amplifier isolation	$V_{CC+} = 5\text{ V}$, $R_L = 100\text{ k}\Omega$ to 2.5 V ⁽³⁾	25°C		135		dB
V_n	Equivalent input noise voltage	$f = 1\text{ kHz}$, $V_{IC} = 1\text{ V}$	25°C		45		nV/ $\sqrt{\text{Hz}}$
I_n	Equivalent input noise current	$f = 1\text{ kHz}$	25°C		0.18		pA/ $\sqrt{\text{Hz}}$
THD	Total harmonic distortion	$f = 1\text{ kHz}$, $A_V = -2$, $R_L = 10\text{ k}\Omega$, $V_O = 4.1\text{ V}_{p-p}$	25°C		0.01		%

- (1) Connected as voltage follower with 1-V step input. Value specified is the slower of the positive and negative slew rates.
 (2) 40-dB closed-loop dc gain, $C_L = 22\text{ pF}$
 (3) Each amplifier excited in turn with 1 kHz to produce $V_O = 3\text{ V}_{p-p}$

5-V ELECTRICAL CHARACTERISTICS

$V_{CC+} = 5\text{ V}$, $V_{CC-} = 0\text{ V}$, $V_{IC} = 2\text{ V}$, $V_O = 2.5\text{ V}$, and $R_L > 1\text{ M}\Omega$ (unless otherwise noted)

PARAMETER		TEST CONDITIONS		T_A	MIN	TYP	MAX	UNIT	
V_{IO}	Input offset voltage			25°C		1	6	mV	
				-40°C to 125°C			6		
α_{VIO}	Average temperature coefficient of input offset voltage			25°C		1		$\mu\text{V}/^\circ\text{C}$	
I_{IB}	Input bias current			25°C		40	100	nA	
				-40°C to 125°C			150		
I_{IO}	Input offset current			25°C		0.5	30	nA	
				-40°C to 125°C			50		
CMRR	Common-mode rejection ratio	$V_{IC} = 0\text{ to }4\text{ V}$		25°C	72	90		dB	
				-40°C to 125°C		70			
$+k_{SVR}$	Positive supply-voltage rejection ratio	$V_{CC+} = 1.7\text{ V to }4\text{ V}$, $V_{CC-} = -1\text{ V}$, $V_O = 0$, $V_{IC} = 0$		25°C	75	85		dB	
				-40°C to 125°C		70			
$-k_{SVR}$	Negative supply-voltage rejection ratio	$V_{CC+} = 1.7\text{ V}$, $V_{CC-} = -1\text{ V to }-3.3\text{ V}$, $V_O = 0$, $V_{IC} = 0$		25°C	73	85		dB	
				-40°C to 125°C		70			
V_{ICR}	Common-mode input voltage range	CMRR $\geq 50\text{ dB}$		25°C	-0.2 to 4.2	-0.3 to 4.3		V	
A_V	Large-signal voltage amplification	$R_L = 600\ \Omega\text{ to }2.5\text{ V}$, $V_O = 2.5\text{ V to }4.5\text{ V}$	Sourcing	25°C	95	105		dB	
			-40°C to 125°C		90				
		Sinking	25°C	95	105				
		-40°C to 125°C		90					
$R_L = 2\text{ k}\Omega\text{ to }2.5\text{ V}$, $V_O = 2.5\text{ V to }4.5\text{ V}$	Sourcing	25°C	95	105					
	-40°C to 125°C		90						
$R_L = 2\text{ k}\Omega\text{ to }2.5\text{ V}$, $V_O = 2.5\text{ V to }4.5\text{ V}$	Sinking	25°C	95	105					
	-40°C to 125°C		90						
V_O	Output swing	$V_{CC+} = 5\text{ V}$, $R_L = 600\ \Omega\text{ to }2.5\text{ V}$		High level	25°C	4.75	4.84	V	
				-40°C to 125°C		4.6			
				Low level	25°C		0.17		0.25
				-40°C to 125°C			0.3		
		$V_{CC+} = 5\text{ V}$, $R_L = 2\text{ k}\Omega\text{ to }2.5\text{ V}$		High level	25°C	4.85	4.9		
				-40°C to 125°C		4.8			
Low level	25°C		0.1	0.15					
-40°C to 125°C				0.2					
I_O	Output current	$V_O = 0\text{ V}$		Sourcing	25°C	20	45	mA	
				-40°C to 125°C		15			
		$V_O = 5\text{ V}$		Sinking	25°C	20	40		
				-40°C to 125°C		15			
I_{CC}	Supply current	LMV821		25°C		0.3	0.4	mA	
				-40°C to 125°C			0.6		
		LMV822 (both amplifiers)		25°C		0.5	0.7		
				-40°C to 125°C			0.9		
		LMV824 (all four amplifiers)		25°C		1	1.3		
				-40°C to 125°C			1.5		

5-V ELECTRICAL CHARACTERISTICS (continued)

$V_{CC+} = 5\text{ V}$, $V_{CC-} = 0\text{ V}$, $V_{IC} = 2\text{ V}$, $V_O = 2.5\text{ V}$, and $R_L > 1\text{ M}\Omega$ (unless otherwise noted)

PARAMETER		TEST CONDITIONS	T_A	MIN	TYP	MAX	UNIT
SR	Slew rate	$V_{CC+} = 5\text{ V}^{(1)}$	25°C	1.4	1.9		V/ μ s
GBW	Gain bandwidth product	⁽²⁾	25°C		5.5		MHz
Φ_m	Phase margin	⁽²⁾	25°C		64.2		deg
	Gain margin	⁽²⁾	25°C		8.7		dB
	Amplifier-to-amplifier isolation	$V_{CC+} = 5\text{ V}$, $R_L = 100\text{ k}\Omega$ to $2.5\text{ V}^{(3)}$	25°C		135		dB
V_n	Equivalent input noise voltage	$f = 1\text{ kHz}$, $V_{IC} = 1\text{ V}$	25°C		42		nV/ $\sqrt{\text{Hz}}$
I_n	Equivalent input noise current	$f = 1\text{ kHz}$	25°C		0.2		pA/ $\sqrt{\text{Hz}}$
THD	Total harmonic distortion	$f = 1\text{ kHz}$, $A_V = -2$, $R_L = 10\text{ k}\Omega$, $V_O = 4.1\text{ V}_{p-p}$	25°C		0.01		%

- (1) Connected as voltage follower with 3-V step input. Value specified is the slower of the positive and negative slew rates.
- (2) 40-dB closed-loop dc gain, $C_L = 22\text{ pF}$
- (3) Each amplifier excited in turn with 1 kHz to produce $V_O = 3\text{ V}_{p-p}$

TYPICAL CHARACTERISTICS

$T_A = 25^\circ\text{C}$, $V_{CC+} = 5\text{-V}$ single supply (unless otherwise noted)

**SUPPLY CURRENT
 vs
 SUPPLY VOLTAGE**

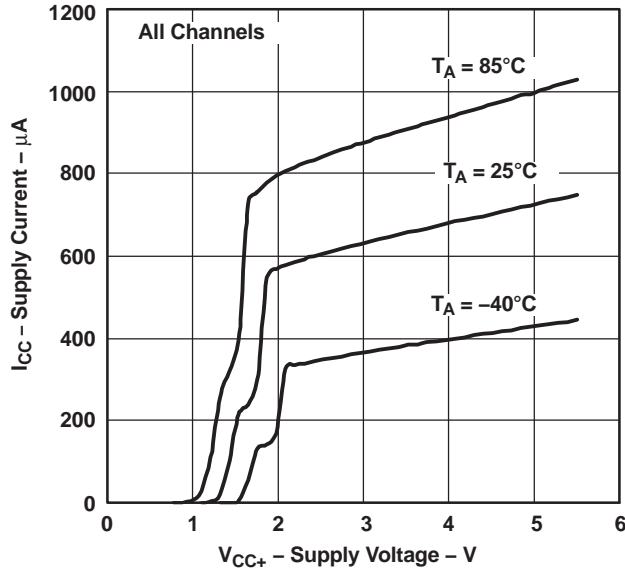

Figure 1.

**INPUT CURRENT
 vs
 TEMPERATURE**

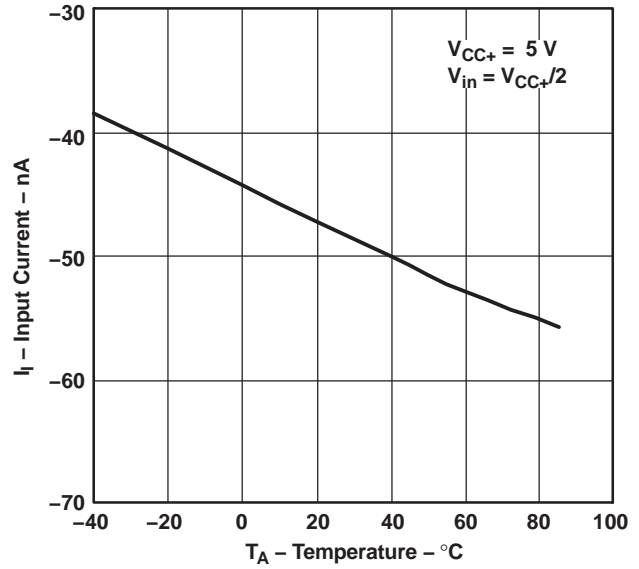

Figure 2.

**SOURCING CURRENT
 vs
 OUTPUT VOLTAGE**

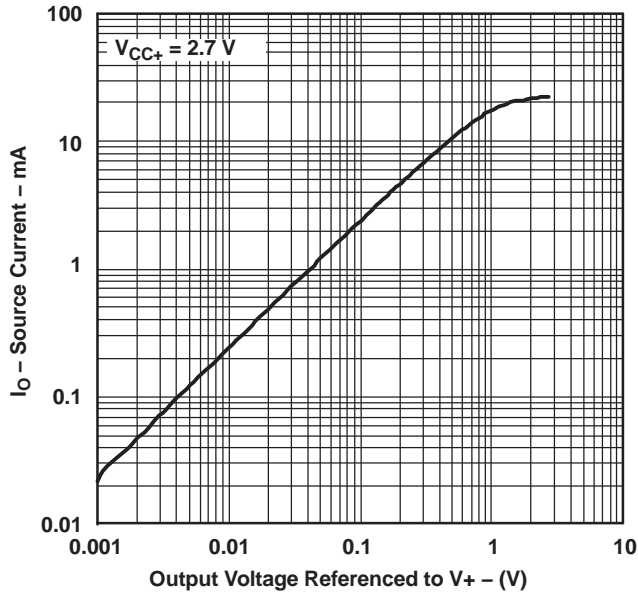

Figure 3.

**SOURCING CURRENT
 vs
 OUTPUT VOLTAGE**

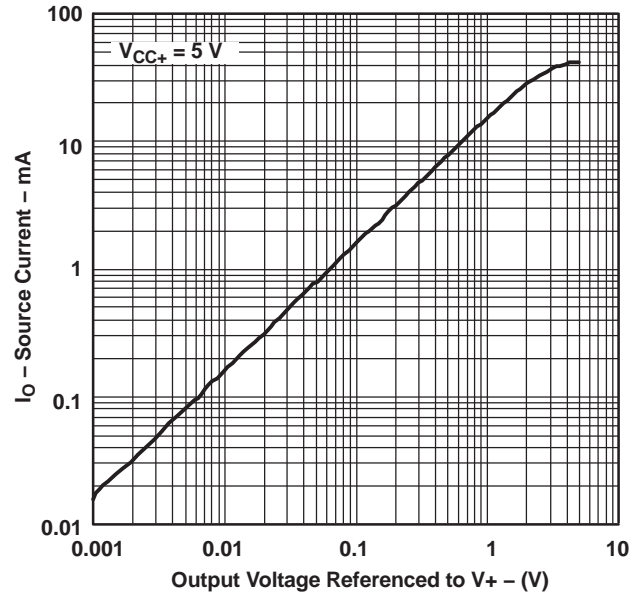

Figure 4.

TYPICAL CHARACTERISTICS (continued)

T_A = 25°C, V_{CC+} = 5-V single supply (unless otherwise noted)

SINKING CURRENT
vs
OUTPUT VOLTAGE

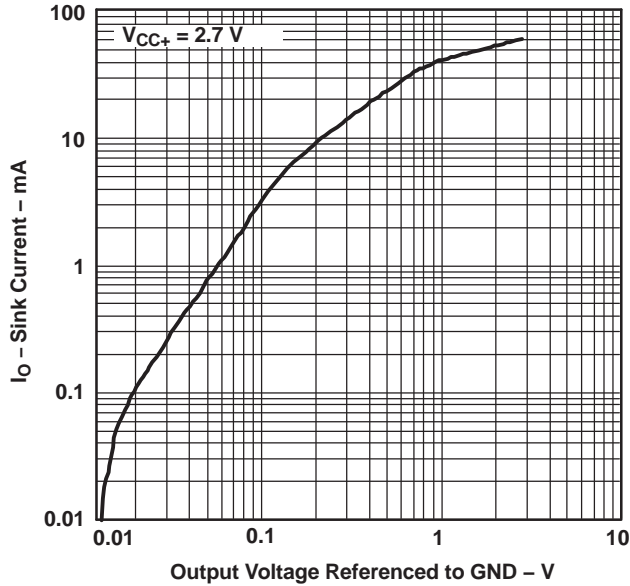

Figure 5.

SINKING CURRENT
vs
OUTPUT VOLTAGE

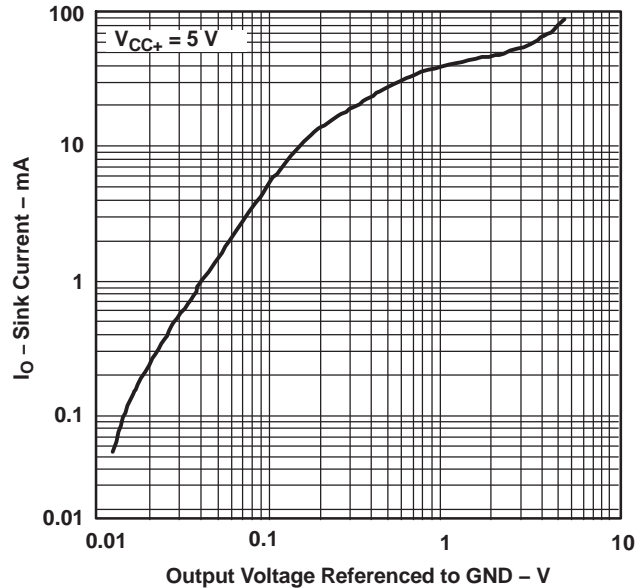

Figure 6.

OUTPUT VOLTAGE SWING
vs
SUPPLY VOLTAGE

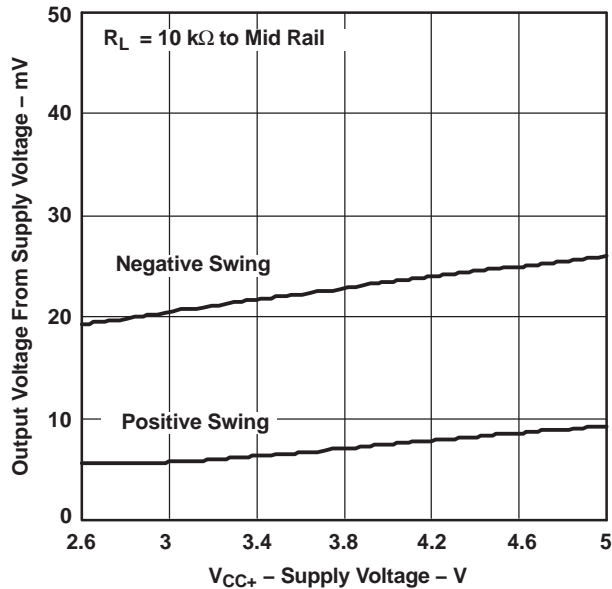

Figure 7.

OUTPUT VOLTAGE SWING
vs
SUPPLY VOLTAGE

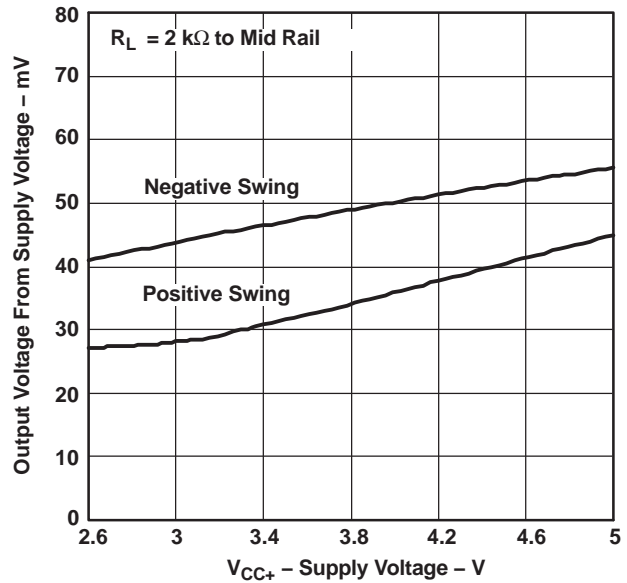

Figure 8.

TYPICAL CHARACTERISTICS (continued)

$T_A = 25^\circ\text{C}$, $V_{CC+} = 5\text{-V}$ single supply (unless otherwise noted)

**OUTPUT VOLTAGE SWING
vs
SUPPLY VOLTAGE**

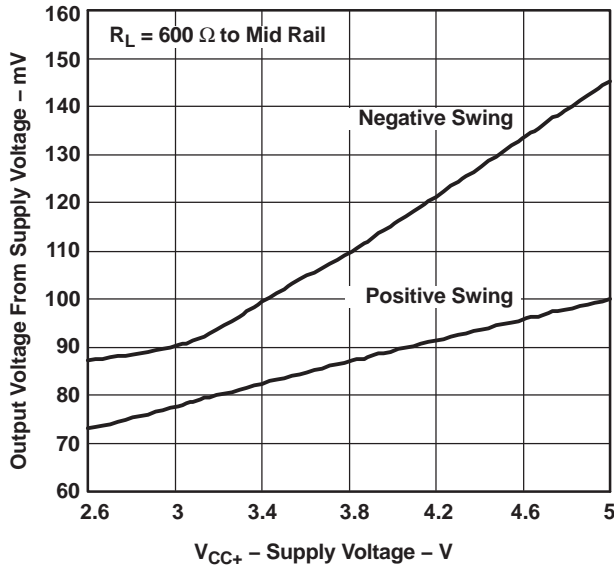

Figure 9.

**OUTPUT VOLTAGE SWING
vs
LOAD RESISTANCE**

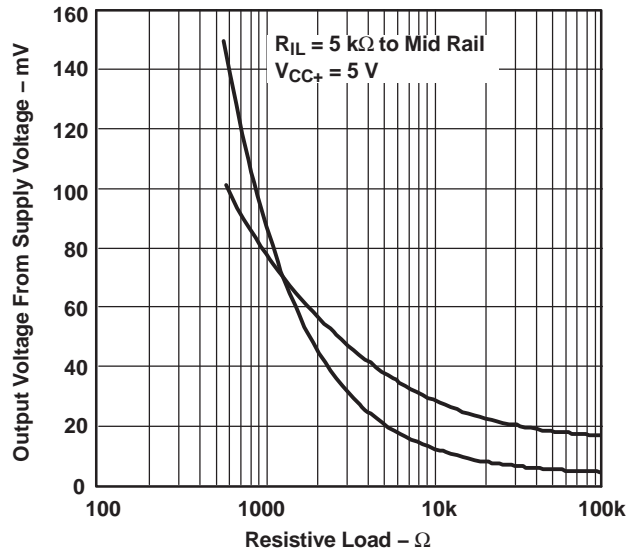

Figure 10.

**CROSSTALK REJECTION
vs
FREQUENCY**

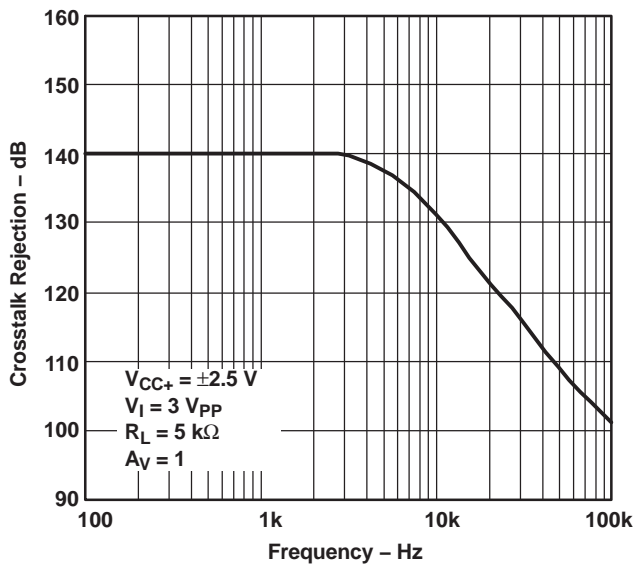

Figure 11.

**+PSRR
vs
FREQUENCY**

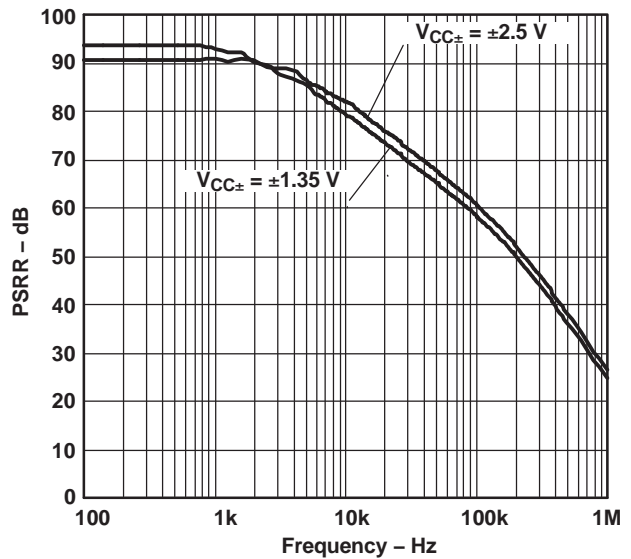
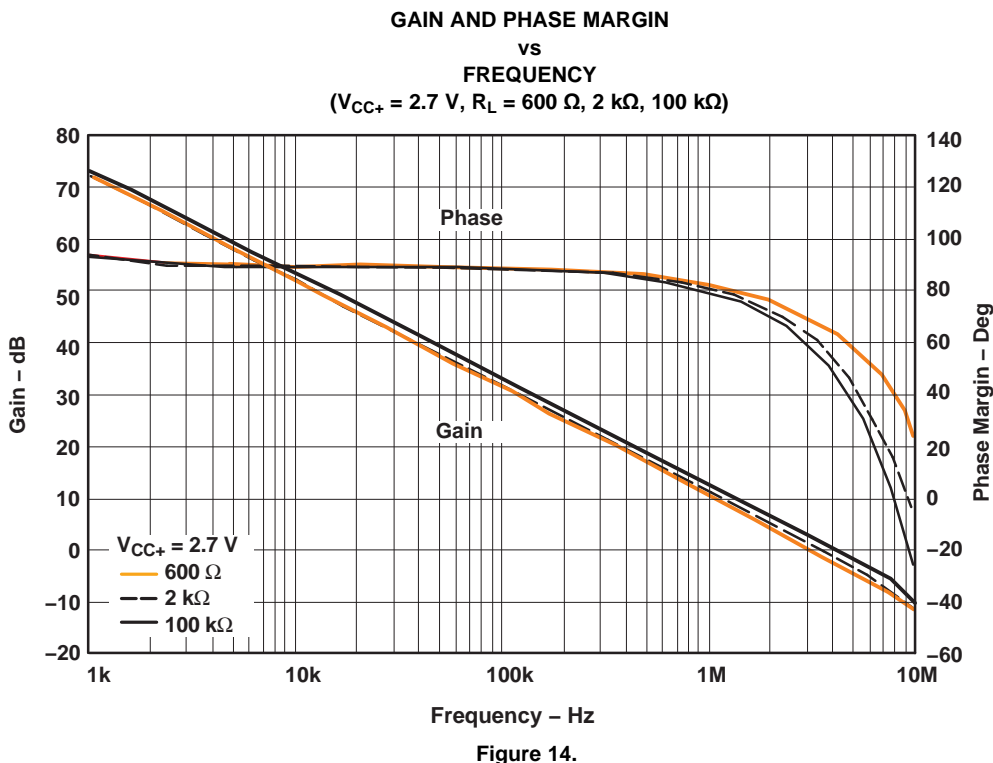
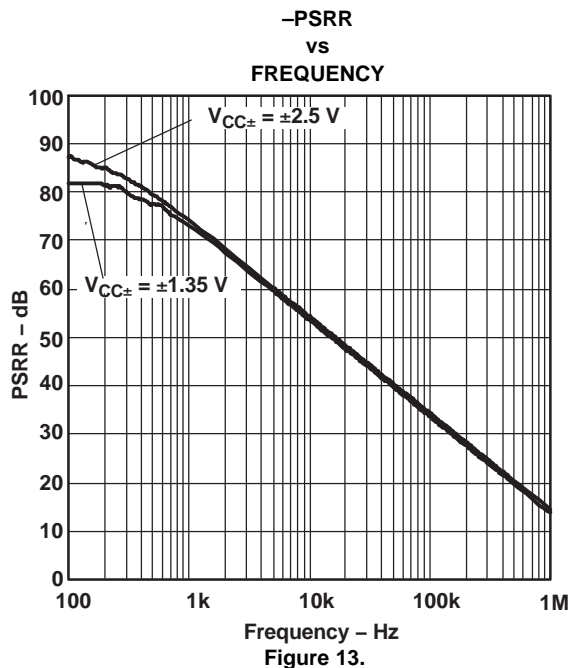

Figure 12.

TYPICAL CHARACTERISTICS (continued)

T_A = 25°C, V_{CC+} = 5-V single supply (unless otherwise noted)



TYPICAL CHARACTERISTICS (continued)

$T_A = 25^\circ\text{C}$, $V_{CC+} = 5\text{-V}$ single supply (unless otherwise noted)

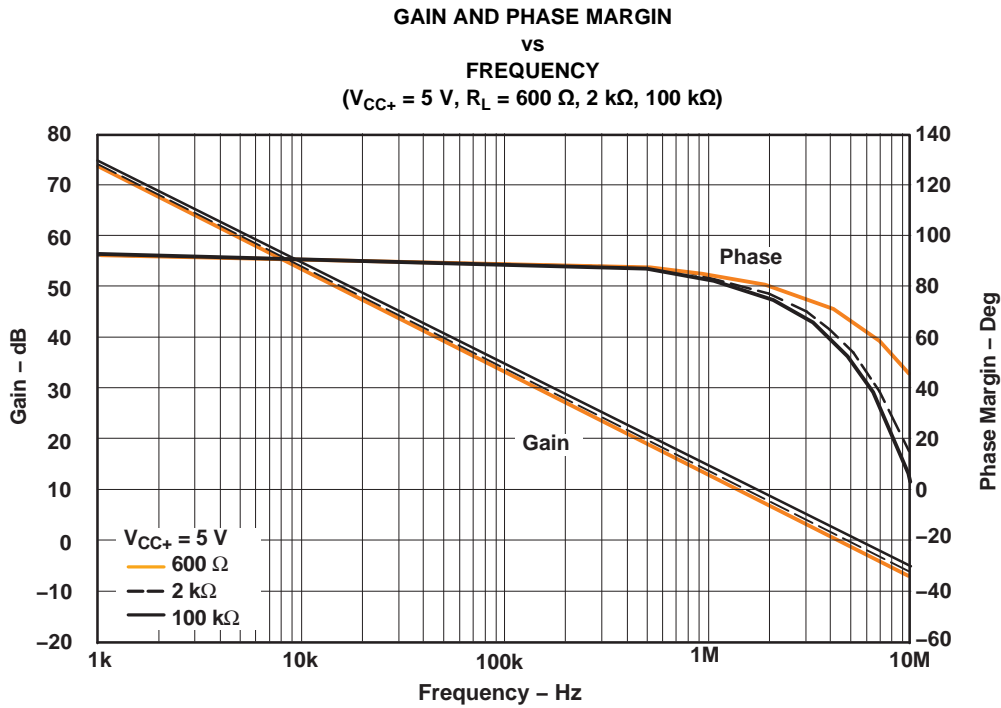

Figure 15.

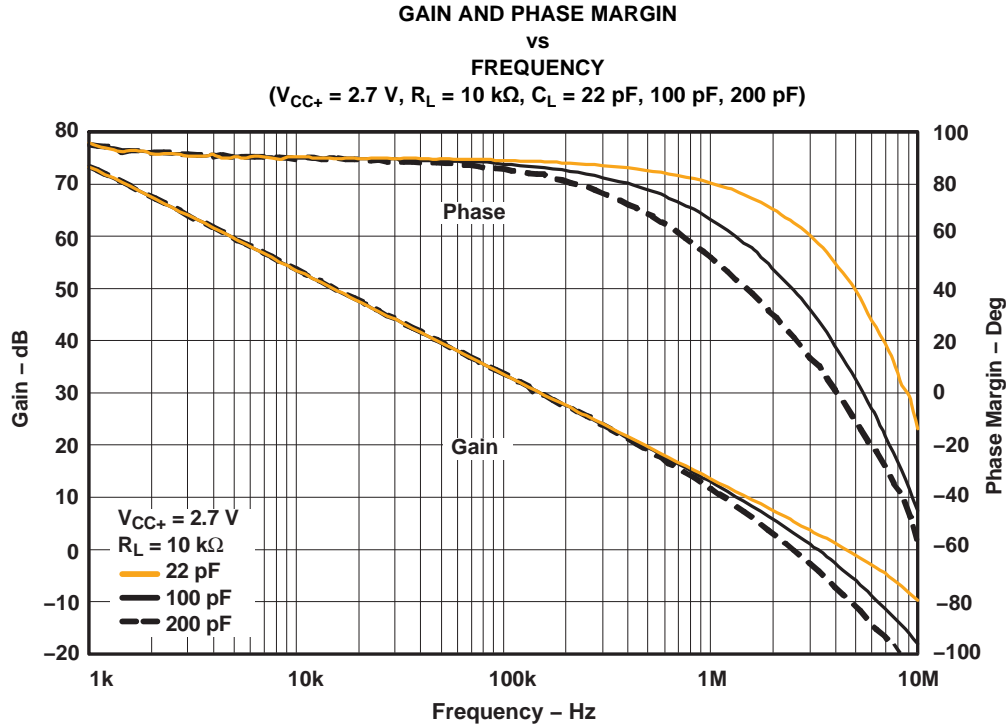

Figure 16.

TYPICAL CHARACTERISTICS (continued)

T_A = 25°C, V_{CC+} = 5-V single supply (unless otherwise noted)

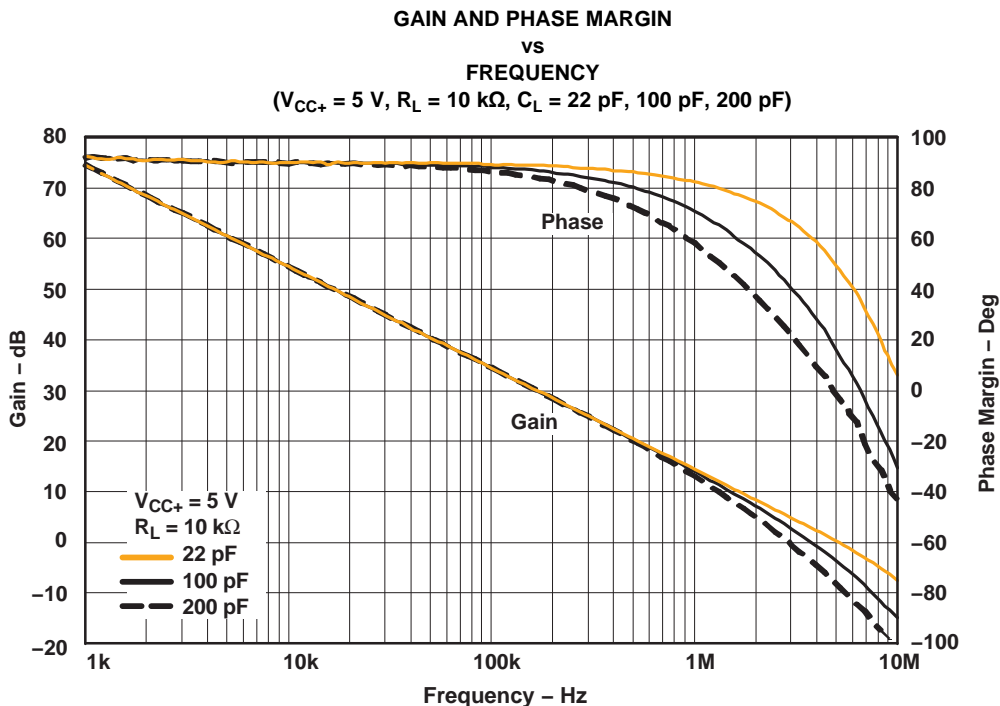

Figure 17.

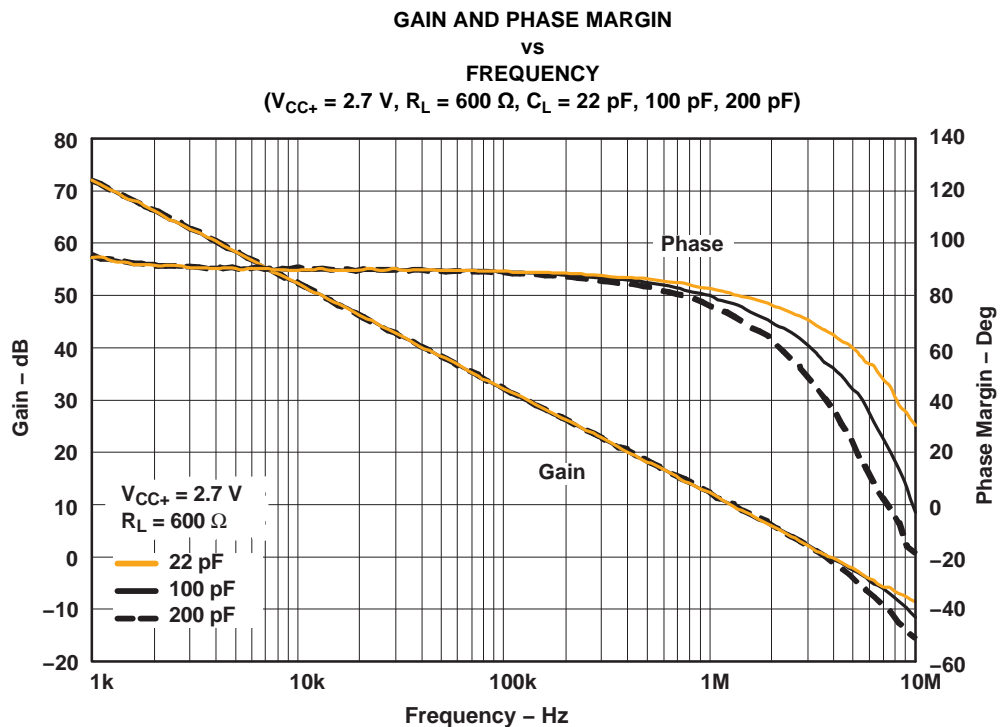
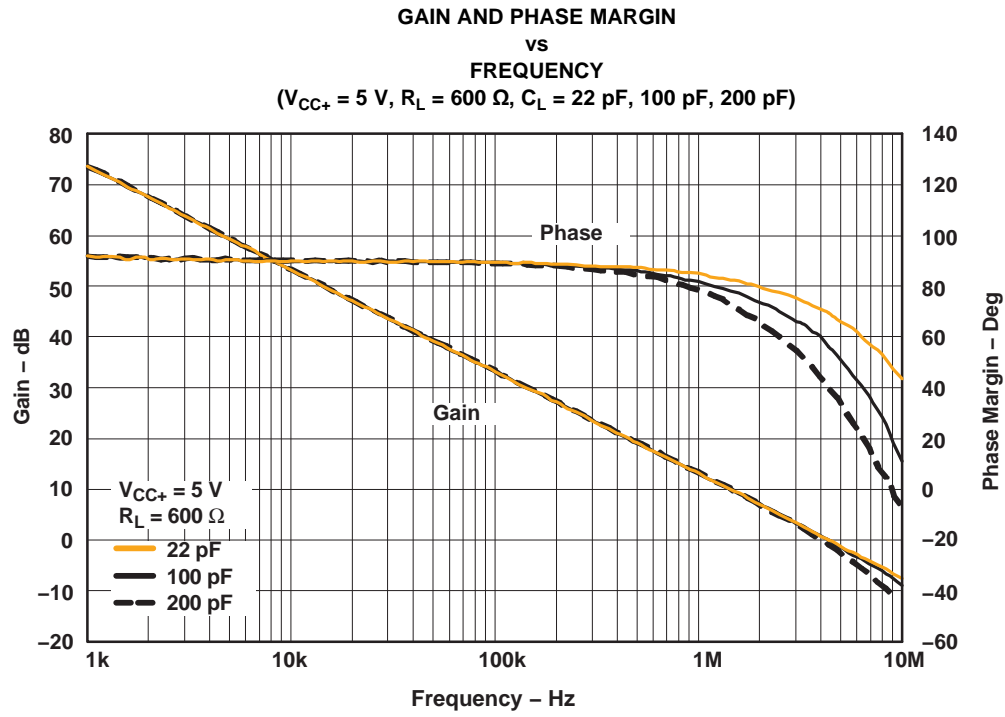

Figure 18.

TYPICAL CHARACTERISTICS (continued)

$T_A = 25^\circ\text{C}$, $V_{CC+} = 5\text{-V}$ single supply (unless otherwise noted)



PACKAGING INFORMATION

Orderable Device	Status (1)	Package Type	Package Drawing	Pins	Package Qty	Eco Plan (2)	Lead/Ball Finish (6)	MSL Peak Temp (3)	Op Temp (°C)	Device Marking (4/5)	Samples
LMV821QDBVRQ1	OBSOLETE	SOT-23	DBV	5		TBD	Call TI	Call TI	-40 to 125	RB1B	

(1) The marketing status values are defined as follows:

ACTIVE: Product device recommended for new designs.

LIFEBUY: TI has announced that the device will be discontinued, and a lifetime-buy period is in effect.

NRND: Not recommended for new designs. Device is in production to support existing customers, but TI does not recommend using this part in a new design.

PREVIEW: Device has been announced but is not in production. Samples may or may not be available.

OBSOLETE: TI has discontinued the production of the device.

(2) Eco Plan - The planned eco-friendly classification: Pb-Free (RoHS), Pb-Free (RoHS Exempt), or Green (RoHS & no Sb/Br) - please check <http://www.ti.com/productcontent> for the latest availability information and additional product content details.

TBD: The Pb-Free/Green conversion plan has not been defined.

Pb-Free (RoHS): TI's terms "Lead-Free" or "Pb-Free" mean semiconductor products that are compatible with the current RoHS requirements for all 6 substances, including the requirement that lead not exceed 0.1% by weight in homogeneous materials. Where designed to be soldered at high temperatures, TI Pb-Free products are suitable for use in specified lead-free processes.

Pb-Free (RoHS Exempt): This component has a RoHS exemption for either 1) lead-based flip-chip solder bumps used between the die and package, or 2) lead-based die adhesive used between the die and leadframe. The component is otherwise considered Pb-Free (RoHS compatible) as defined above.

Green (RoHS & no Sb/Br): TI defines "Green" to mean Pb-Free (RoHS compatible), and free of Bromine (Br) and Antimony (Sb) based flame retardants (Br or Sb do not exceed 0.1% by weight in homogeneous material)

(3) MSL, Peak Temp. - The Moisture Sensitivity Level rating according to the JEDEC industry standard classifications, and peak solder temperature.

(4) There may be additional marking, which relates to the logo, the lot trace code information, or the environmental category on the device.

(5) Multiple Device Markings will be inside parentheses. Only one Device Marking contained in parentheses and separated by a "~" will appear on a device. If a line is indented then it is a continuation of the previous line and the two combined represent the entire Device Marking for that device.

(6) Lead/Ball Finish - Orderable Devices may have multiple material finish options. Finish options are separated by a vertical ruled line. Lead/Ball Finish values may wrap to two lines if the finish value exceeds the maximum column width.

Important Information and Disclaimer: The information provided on this page represents TI's knowledge and belief as of the date that it is provided. TI bases its knowledge and belief on information provided by third parties, and makes no representation or warranty as to the accuracy of such information. Efforts are underway to better integrate information from third parties. TI has taken and continues to take reasonable steps to provide representative and accurate information but may not have conducted destructive testing or chemical analysis on incoming materials and chemicals. TI and TI suppliers consider certain information to be proprietary, and thus CAS numbers and other limited information may not be available for release.

In no event shall TI's liability arising out of such information exceed the total purchase price of the TI part(s) at issue in this document sold by TI to Customer on an annual basis.

OTHER QUALIFIED VERSIONS OF LMV821-Q1 :

- Catalog: [LMV821](#)

NOTE: Qualified Version Definitions:

- Catalog - TI's standard catalog product

IMPORTANT NOTICE

Texas Instruments Incorporated and its subsidiaries (TI) reserve the right to make corrections, enhancements, improvements and other changes to its semiconductor products and services per JESD46, latest issue, and to discontinue any product or service per JESD48, latest issue. Buyers should obtain the latest relevant information before placing orders and should verify that such information is current and complete. All semiconductor products (also referred to herein as "components") are sold subject to TI's terms and conditions of sale supplied at the time of order acknowledgment.

TI warrants performance of its components to the specifications applicable at the time of sale, in accordance with the warranty in TI's terms and conditions of sale of semiconductor products. Testing and other quality control techniques are used to the extent TI deems necessary to support this warranty. Except where mandated by applicable law, testing of all parameters of each component is not necessarily performed.

TI assumes no liability for applications assistance or the design of Buyers' products. Buyers are responsible for their products and applications using TI components. To minimize the risks associated with Buyers' products and applications, Buyers should provide adequate design and operating safeguards.

TI does not warrant or represent that any license, either express or implied, is granted under any patent right, copyright, mask work right, or other intellectual property right relating to any combination, machine, or process in which TI components or services are used. Information published by TI regarding third-party products or services does not constitute a license to use such products or services or a warranty or endorsement thereof. Use of such information may require a license from a third party under the patents or other intellectual property of the third party, or a license from TI under the patents or other intellectual property of TI.

Reproduction of significant portions of TI information in TI data books or data sheets is permissible only if reproduction is without alteration and is accompanied by all associated warranties, conditions, limitations, and notices. TI is not responsible or liable for such altered documentation. Information of third parties may be subject to additional restrictions.

Resale of TI components or services with statements different from or beyond the parameters stated by TI for that component or service voids all express and any implied warranties for the associated TI component or service and is an unfair and deceptive business practice. TI is not responsible or liable for any such statements.

Buyer acknowledges and agrees that it is solely responsible for compliance with all legal, regulatory and safety-related requirements concerning its products, and any use of TI components in its applications, notwithstanding any applications-related information or support that may be provided by TI. Buyer represents and agrees that it has all the necessary expertise to create and implement safeguards which anticipate dangerous consequences of failures, monitor failures and their consequences, lessen the likelihood of failures that might cause harm and take appropriate remedial actions. Buyer will fully indemnify TI and its representatives against any damages arising out of the use of any TI components in safety-critical applications.

In some cases, TI components may be promoted specifically to facilitate safety-related applications. With such components, TI's goal is to help enable customers to design and create their own end-product solutions that meet applicable functional safety standards and requirements. Nonetheless, such components are subject to these terms.

No TI components are authorized for use in FDA Class III (or similar life-critical medical equipment) unless authorized officers of the parties have executed a special agreement specifically governing such use.

Only those TI components which TI has specifically designated as military grade or "enhanced plastic" are designed and intended for use in military/aerospace applications or environments. Buyer acknowledges and agrees that any military or aerospace use of TI components which have **not** been so designated is solely at the Buyer's risk, and that Buyer is solely responsible for compliance with all legal and regulatory requirements in connection with such use.

TI has specifically designated certain components as meeting ISO/TS16949 requirements, mainly for automotive use. In any case of use of non-designated products, TI will not be responsible for any failure to meet ISO/TS16949.

Products

Audio	www.ti.com/audio
Amplifiers	amplifier.ti.com
Data Converters	dataconverter.ti.com
DLP® Products	www.dlp.com
DSP	dsp.ti.com
Clocks and Timers	www.ti.com/clocks
Interface	interface.ti.com
Logic	logic.ti.com
Power Mgmt	power.ti.com
Microcontrollers	microcontroller.ti.com
RFID	www.ti-rfid.com
OMAP Applications Processors	www.ti.com/omap
Wireless Connectivity	www.ti.com/wirelessconnectivity

Applications

Automotive and Transportation	www.ti.com/automotive
Communications and Telecom	www.ti.com/communications
Computers and Peripherals	www.ti.com/computers
Consumer Electronics	www.ti.com/consumer-apps
Energy and Lighting	www.ti.com/energy
Industrial	www.ti.com/industrial
Medical	www.ti.com/medical
Security	www.ti.com/security
Space, Avionics and Defense	www.ti.com/space-avionics-defense
Video and Imaging	www.ti.com/video

TI E2E Community

e2e.ti.com