

LP2951-xx-Q1 Adjustable Micropower Voltage Regulators With Shutdown

1 Features

- Qualified for Automotive Applications
- Wide Input Range: Up to 35 V
- Rated Output Current of 100 mA
- Low Dropout: 380 mV (Typ) at 100 mA
- Low Quiescent Current: 75 μ A (Typ)
- Tight Line Regulation: 0.03% (Typ)
- Tight Load Regulation: 0.04% (Typ)
- High V_O Accuracy
 - 1.4% at 25°C
 - 2% Over Temperature
- Can Be Used as a Regulator or Reference
- Stable With Low ESR (>12 m Ω) Capacitors
- Current- and Thermal-Limiting Features
- 8-Pin Package
 - Fixed Voltages: 5 V/ADJ and 3.3 V/ADJ
 - Low-Voltage Error Signal on Falling Output
 - Shutdown Capability
 - Remote Sense Capability for Optimal Output Regulation and Accuracy

2 Applications

- Automotive Power
 - Battery to MCU Regulator
 - Sensor Supply
 - Infotainment
 - Body Control Module
- Secondary Side Regulation
- Point of Load Regulation

3 Description

The LP2951-xx-Q1 devices are bipolar, low-dropout voltage regulators that can accommodate a wide input supply-voltage range of up to 35 V. The 8-pin LP2951-xx-Q1 is able to output either a fixed or adjustable output from the same device. By tying the OUTPUT and SENSE pins together, and the FEEDBACK and V_{TAP} pins together, the LP2951-xx-Q1 outputs a fixed 5 V and 3.3 V (depending on the version). Alternatively, by leaving the SENSE and V_{TAP} pins open and connecting FEEDBACK to an external resistor divider, the output can be set to any value between 1.235 V to 30 V.

The 8-pin LP2951-xx-Q1 also offers additional functionality that makes it particularly suitable for battery-powered applications. For example, a logic-compatible shutdown feature allows the regulator to be put in standby mode for power savings. In addition, there is a built-in supervisor reset function in which the ERROR output goes low when V_{OUT} drops by 6% of its nominal value for whatever reasons – due to a drop in V_{IN} , current limiting, or thermal shutdown.

The LP295x-xx-Q1 devices are designed to minimize all error contributions to the output voltage. With a tight output tolerance (0.5% at 25°C), a very low output voltage temperature coefficient (20 ppm typical), extremely good line and load regulation (0.3% and 0.4% typical), and remote sensing capability, the parts can be used as either low-power voltage references or 100-mA regulators.

Device Information⁽¹⁾

PART NUMBER	PACKAGE	BODY SIZE (NOM)
LP2951-33-Q1	SOIC (8)	4.90 mm x 3.90 mm
LP2591-50-Q1		
LP2951-50-Q1	WSON (8)	3.00 mm x 3.00 mm

(1) For all available packages, see the orderable addendum at the end of the data sheet.

Dropout Voltage vs Temperature

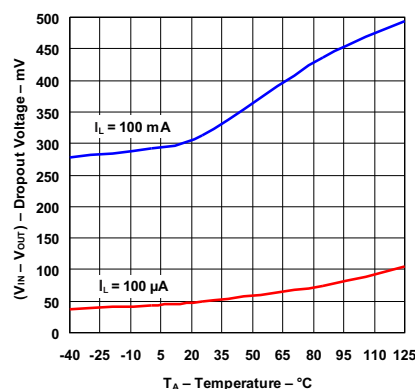

Table of Contents

1 Features	1	7.3 Feature Description.....	14
2 Applications	1	7.4 Device Functional Modes.....	15
3 Description	1	8 Application and Implementation	16
4 Revision History	2	8.1 Application Information.....	16
5 Pin Configuration and Functions	3	8.2 Typical Application	16
6 Specifications	3	9 Power Supply Recommendations	19
6.1 Absolute Maximum Ratings	3	10 Layout	19
6.2 Handling Ratings.....	3	10.1 Layout Guidelines	19
6.3 Recommended Operating Conditions.....	4	10.2 Layout Example	19
6.4 Thermal Information	4	11 Device and Documentation Support	19
6.5 Electrical Characteristics.....	4	11.1 Related Links	19
6.6 Typical Characteristics	6	11.2 Trademarks	19
7 Detailed Description	12	11.3 Electrostatic Discharge Caution.....	19
7.1 Overview	12	11.4 Glossary	19
7.2 LP2951-xx-Q1 Functional Block Diagram.....	13	12 Mechanical, Packaging, and Orderable Information	20

4 Revision History

NOTE: Page numbers for previous revisions may differ from page numbers in the current version.

Changes from Revision D (April 2013) to Revision E Page

- Added *Handling Rating* table, *Feature Description* section, *Device Functional Modes*, *Application and Implementation* section, *Power Supply Recommendations* section, *Layout* section, *Device and Documentation Support* section, and *Mechanical, Packaging, and Orderable Information* section

1

Changes from Revision C (February 2013) to Revision D Page

- Deleted unreleased devices
- Added the THERMAL INFORMATION table

1

4

Changes from Revision B (December 2012) to Revision C Page

- Deleted P/N LP2951-Q1 from page header
- Deleted ORDERING INFORMATION table.....

1

3

Changes from Revision A (July 2012) to Revision B Page

- Changed LP2951-33QDRGRQ1 From: Preview To: Active

3

Changes from Original (June, 2011) to Revision A Page

- Removed continuous from input voltage range parameter description; changed max values for V_{IN} and V_{SHDN} from 30 to 35.....

3

5 Pin Configuration and Functions

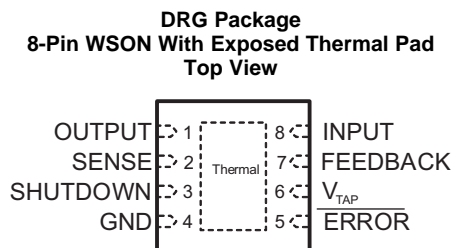
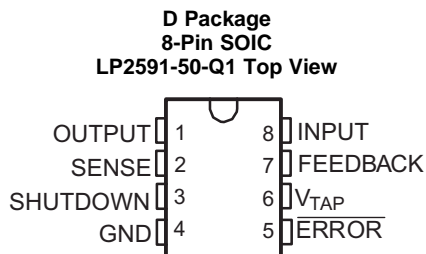

Pin Functions

PIN		TYPE	DESCRIPTION
NAME	NO.		
$\overline{\text{ERROR}}$	5	O	Active-low open-collector error output. Goes low when V_{OUT} drops by 6% of its nominal value.
FEEDBACK	7	I	Determines the output voltage. Connect to V_{TAP} (with OUTPUT tied to SENSE) to output the fixed voltage corresponding to the part version, or connect to a resistor divider to adjust the output voltage.
GND	4	—	Ground
INPUT	8	I	Supply input
OUTPUT	1	O	Voltage output.
SENSE	2	I	Senses the output voltage. Connect to OUTPUT (with FEEDBACK tied to V_{TAP}) to output the voltage corresponding to the part version.
SHUTDOWN	3	I	Active-high input. Shuts down the device.
V_{TAP}	6	O	Tie to FEEDBACK to output the fixed voltage corresponding to the part version.

6 Specifications

6.1 Absolute Maximum Ratings⁽¹⁾

over operating free-air temperature range (unless otherwise noted)

	MIN	MAX	UNIT
V_{IN} Input voltage range	–0.3	35	V
V_{SHDN} SHUTDOWN input voltage range	–1.5	35	V
$\overline{\text{ERROR}}$ comparator output voltage range ⁽²⁾	–1.5	30	V
V_{FDBK} FEEDBACK input voltage range ^{(2) (3)}	–1.5	30	V
T_{J} Operating virtual-junction temperature		150	°C

(1) Stresses beyond those listed under "absolute maximum ratings" may cause permanent damage to the device. These are stress ratings only, and functional operation of the device at these or any other conditions beyond those indicated under "recommended operating conditions" is not implied. Exposure to absolute-maximum-rated conditions for extended periods may affect device reliability.

(2) May exceed input supply voltage

(3) If load is returned to a negative power supply, the output must be diode clamped to GND.

6.2 Handling Ratings

	MIN	MAX	UNIT	
T_{stg} Storage temperature range	–65	150	°C	
$V_{\text{(ESD)}}$ Electrostatic discharge	Human body model (HBM), per AEC Q100-002 ⁽¹⁾⁽²⁾		V	
	Charged device model (CDM), per AEC Q100-011	Corner pins (1, 4, 8, and 5)		0
		Other pins		0

(1) AEC Q100-002 indicates HBM stressing is done in accordance with the ANSI/ESDA/JEDEC JS-001 specification.

(2) LP2951-50QDRQ1 Feedback pin survives up to 1500V HBM

6.3 Recommended Operating Conditions

		MIN	NOM	MAX	UNIT
V_{IN}	Supply input voltage	See ⁽¹⁾		30	V
T_A	Operating temperature	–40		125	°C

- (1) Minimum V_{IN} is the greater of:
 (a) 2 V (25°C), 2.3 V (over temperature), or
 (b) $V_{OUT(MAX)} + \text{Dropout (Max)}$ at rated I_L

6.4 Thermal Information

THERMAL METRIC		LP2951-30-Q1, LP2951-50-Q1	LP2951-50-Q1	UNIT
		DRG	D	
		8 PINS	8 PINS	
$R_{\theta JA}$	Junction-to-ambient thermal resistance	55.7	121.6	°C/W
$R_{\theta JC(top)}$	Junction-to-case (top) thermal resistance	66.5	69.8	
$R_{\theta JB}$	Junction-to-board thermal resistance	30.2	61.9	
Ψ_{JT}	Junction-to-top characterization parameter	1.1	22.2	
Ψ_{JB}	Junction-to-board characterization parameter	30.4	61.4	
$R_{\theta JC(bot)}$	Junction-to-case (bottom) thermal resistance	10	n/a	

6.5 Electrical Characteristics

$V_{IN} = V_{OUT}$ (nominal) + 1 V, $I_L = 100 \mu\text{A}$, $C_L = 1 \mu\text{F}$ (5-V versions) or $C_L = 2.2 \mu\text{F}$ (3.3-V versions),
 8-pin version: FEEDBACK tied to V_{TAP} , OUTPUT tied to SENSE, $V_{SHUTDOWN} \leq 0.7 \text{ V}$

PARAMETER	TEST CONDITIONS	T_A	MIN	TYP	MAX	UNIT	
3.3-V VERSION (LP2951-33-Q1)							
V_{OUT}	Output voltage	$I_L = 100 \mu\text{A}$	25°C	3.267	3.3	3.333	V
			–40°C to 125°C	3.234	3.3	3.366	
5-V VERSION (LP2951-50-Q1)							
V_{OUT}	Output voltage	$I_L = 100 \mu\text{A}$	25°C	4.950	5	5.050	V
			–40°C to 125°C	4.900	5	5.100	
ALL VOLTAGE OPTIONS							
	Output voltage temperature coefficient ⁽¹⁾	$I_L = 100 \mu\text{A}$	–40°C to 125°C	20	100	ppm/°C	
	Line regulation ⁽²⁾	$V_{IN} = [V_{OUT(NOM)} + 1 \text{ V}] \text{ to } 30 \text{ V}$	25°C	0.03	0.2	%V	
			–40°C to 125°C		0.4		
	Load regulation ⁽²⁾	$I_L = 100 \mu\text{A}$ to 100 mA	25°C	0.04%	0.2%		
			–40°C to 125°C		0.3%		
$V_{IN} - V_{OUT}$	Dropout voltage ⁽³⁾	$I_L = 100 \mu\text{A}$	25°C	50	80	mV	
			–40°C to 125°C		150		
		$I_L = 100 \text{ mA}$	25°C	380	450		
			–40°C to 125°C		600		
I_{GND}	GND current	$I_L = 100 \mu\text{A}$	25°C	75	120	μA	
			–40°C to 125°C		140		
		$I_L = 100 \text{ mA}$	25°C	8	12	mA	
			–40°C to 125°C		14		
	Dropout ground current	$V_{IN} = V_{OUT(NOM)} - 0.5 \text{ V}$, $I_L = 100 \mu\text{A}$	25°C	110	170	μA	
			–40°C to 125°C		200		
	Current limit	$V_{OUT} = 0 \text{ V}$	25°C	160	200	mA	
			–40°C to 125°C		220		

- (1) Output or reference voltage temperature coefficient is defined as the worst-case voltage change divided by the total temperature range.
 (2) Regulation is measured at constant junction temperature, using pulse testing with a low duty cycle. Changes in output voltage due to heating effects are covered under the specification for thermal regulation.
 (3) Dropout voltage is defined as the input-to-output differential at which the output voltage drops 100 mV, below the value measured at 1-V differential. The minimum input supply voltage of 2 V (2.3 V over temperature) must be observed.

Electrical Characteristics (continued)

$V_{IN} = V_{OUT}$ (nominal) + 1 V, $I_L = 100 \mu\text{A}$, $C_L = 1 \mu\text{F}$ (5-V versions) or $C_L = 2.2 \mu\text{F}$ (3.3-V versions),
8-pin version: FEEDBACK tied to V_{TAP} , OUTPUT tied to SENSE, $V_{SHUTDOWN} \leq 0.7$ V

PARAMETER	TEST CONDITIONS	T_A	MIN	TYP	MAX	UNIT
Thermal regulation ⁽⁴⁾	$I_L = 100 \mu\text{A}$	25°C		0.05	0.2	%/W
Output noise (RMS), 10 Hz to 100 kHz	$C_L = 1 \mu\text{F}$ (5 V only)	25°C		430		μV
	$C_L = 200 \mu\text{F}$			160		
	LP2951-50-Q1: $C_L = 3.3 \mu\text{F}$, $C_{Bypass} = 0.01 \mu\text{F}$ between pins 1 and 7			100		
Reference voltage ⁽⁵⁾	$V_{OUT} = V_{REF}$ to $(V_{IN} - 1 \text{ V})$, $V_{IN} = 2.3 \text{ V}$ to 30 V, $I_L = 100 \mu\text{A}$ to 100 mA	-40°C to 125°C	1.200		1.272	V
Reference voltage temperature coefficient ⁽¹⁾		25°C		20		ppm/°C
ERROR COMPARATOR						
Output leakage current	$V_{OUT} = 30 \text{ V}$	25°C		0.01	1	μA
		-40°C to 125°C			2	
Output low voltage	$V_{IN} = V_{OUT(NOM)} - 0.5 \text{ V}$, $I_{OL} = 400 \mu\text{A}$	25°C		150	250	mV
		-40°C to 125°C			400	
Upper threshold voltage (ERROR output high) ⁽⁶⁾		25°C	40	60		mV
		-40°C to 125°C	25			
Lower threshold voltage (ERROR output low) ⁽⁶⁾		25°C		75	95	mV
		-40°C to 125°C			140	
Hysteresis ⁽⁶⁾		25°C		15		mV
SHUTDOWN INPUT						
Input logic voltage	Low (regulator ON)	-40°C to 125°C			0.7	V
	High (regulator OFF)			2		
SHUTDOWN input current	$V_{TAP} = 2.4 \text{ V}$	25°C		30	50	μA
		-40°C to 125°C			100	
	$V_{TAP} = 30 \text{ V}$	25°C		450	600	
		-40°C to 125°C			750	
Regulator output current in shutdown	$V_{SHUTDOWN} \geq 2 \text{ V}$, $V_{IN} \leq 30 \text{ V}$, $V_{OUT} = 0$, FEEDBACK tied to V_{TAP}	25°C		3	10	μA
		-40°C to 125°C			20	

- (4) Thermal regulation is defined as the change in output voltage at a time (T) after a change in power dissipation is applied, excluding load or line regulation effects. Specifications are for a 50-mA load pulse at $V_{IN} = 30 \text{ V}$, $V_{OUT} = 5 \text{ V}$ (1.25-W pulse) for $t = 10 \text{ ms}$.
- (5) For LP2951-50QDR in SOIC package, V_{REF} is tested at $V_{IN} = 6 \text{ V}$ and $I_{OUT} = 100 \mu\text{A}$.
- (6) Comparator thresholds are expressed in terms of a voltage differential equal to the nominal reference voltage (measured at $V_{IN} - V_{OUT} = 1 \text{ V}$) minus FEEDBACK terminal voltage. To express these thresholds in terms of output voltage change, multiply by the error amplifier gain $= V_{OUT}/V_{REF} = (R1 + R2)/R2$. For example, at a programmed output voltage of 5 V, the ERROR output is specified to go low when the output drops by $95 \text{ mV} \times 5 \text{ V}/1.235 \text{ V} = 384 \text{ mV}$. Thresholds remain constant as a percentage of V_{OUT} (as V_{OUT} is varied), with the low-output warning occurring at 6% below nominal (typical) and 7.7% (maximum).

6.6 Typical Characteristics

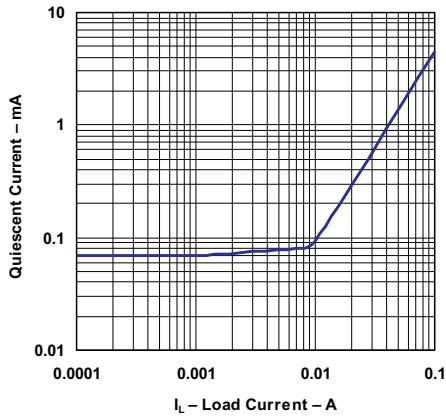

Figure 1. Quiescent Current vs Load Current

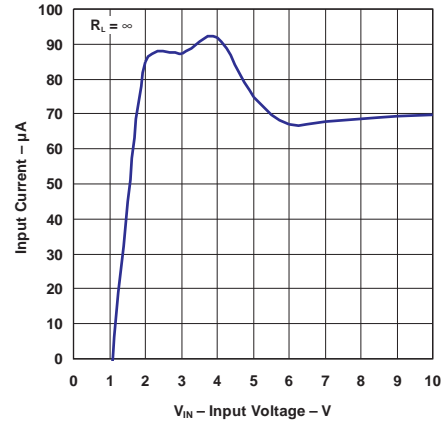

Figure 2. Input Current vs Input Voltage

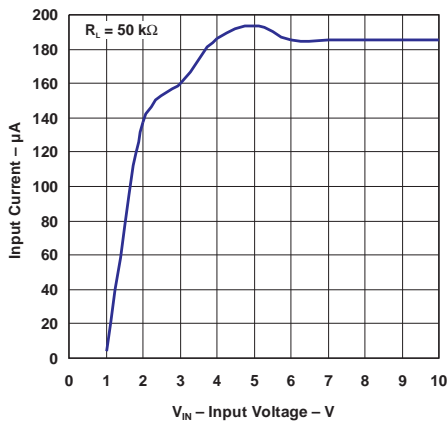

Figure 3. Input Current vs Input Voltage

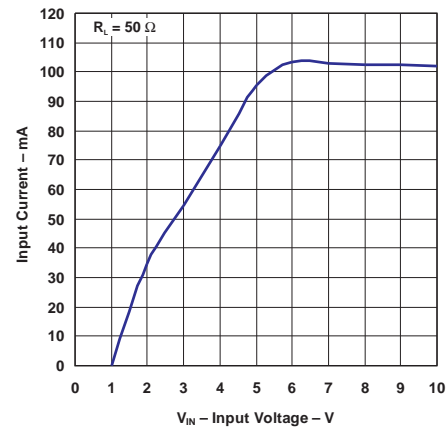

Figure 4. Input Current vs Input Voltage

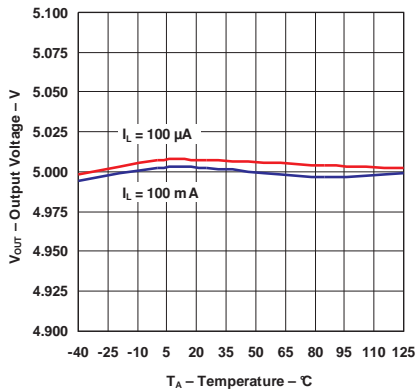

Figure 5. Output Voltage vs Temperature

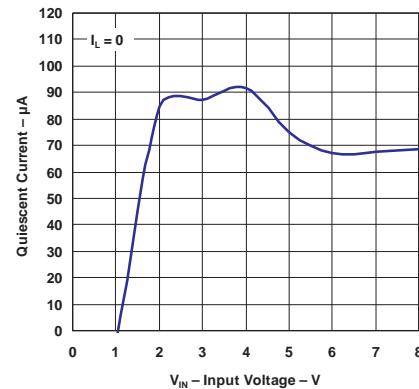

Figure 6. Quiescent Current vs Input Voltage

Typical Characteristics (continued)

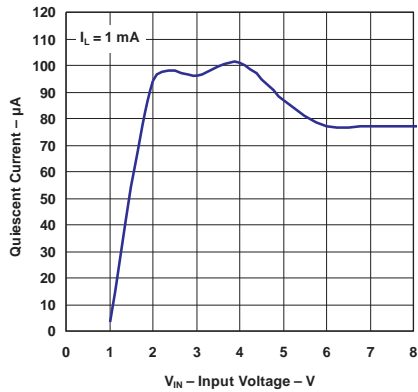

Figure 7. Quiescent Current vs Input Voltage

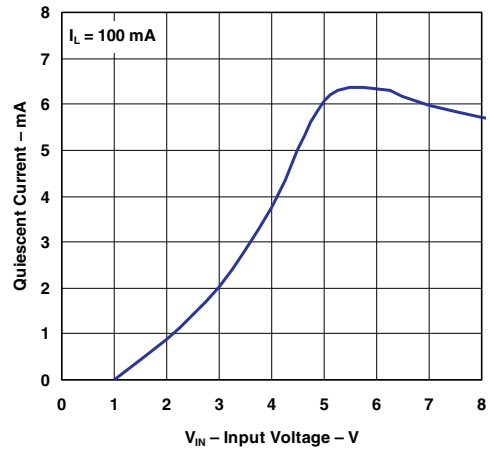

Figure 8. Quiescent Current vs Input Voltage

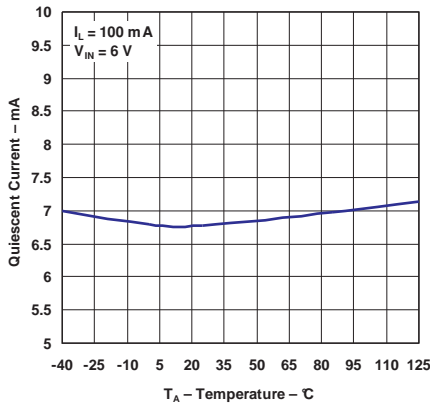

Figure 9. Quiescent Current vs Temperature

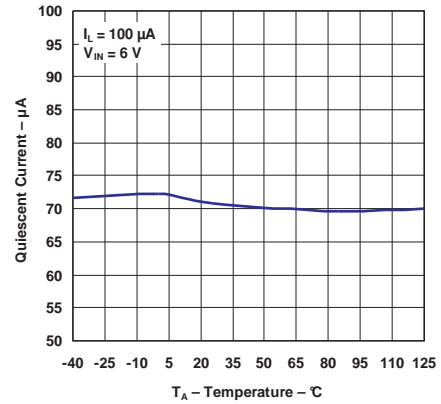

Figure 10. Quiescent Current vs Temperature

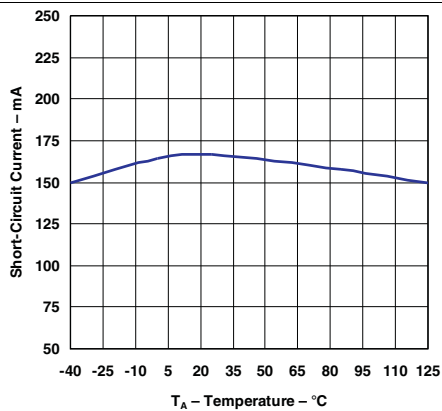

Figure 11. Short-Circuit Current vs Temperature

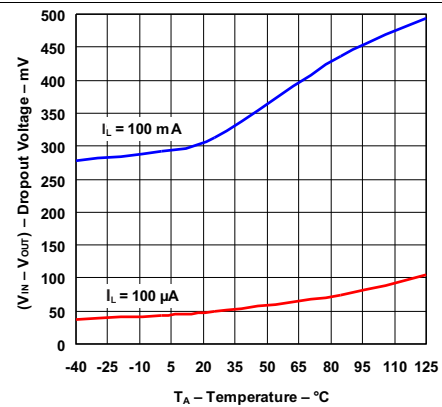

Figure 12. Dropout Voltage vs Temperature

Typical Characteristics (continued)

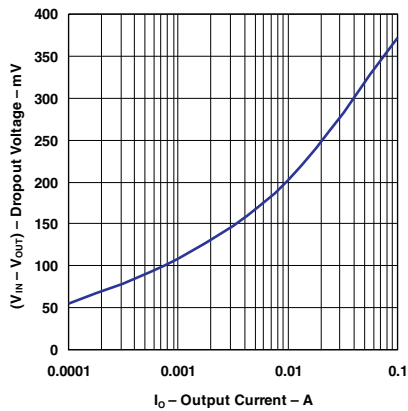

Figure 13. Dropout Voltage vs Output Current

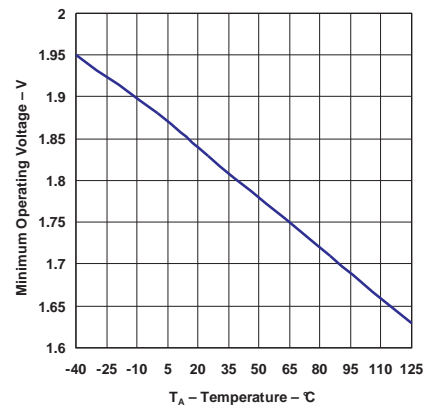

Figure 14. Minimum Operating Voltage vs Temperature

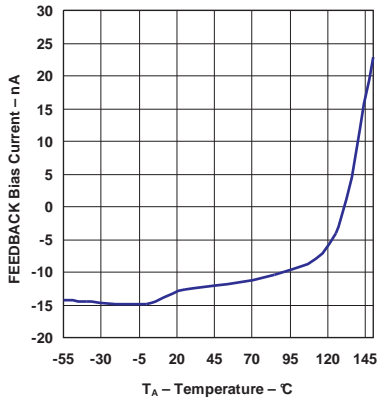

Figure 15. Feedback Bias Current vs Temperature

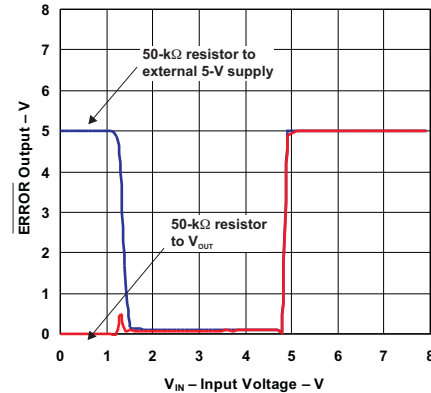

Figure 16. $\overline{\text{ERROR}}$ Comparator Output vs Input Voltage

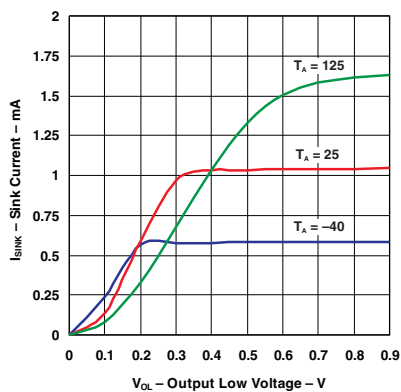

Figure 17. $\overline{\text{ERROR}}$ Comparator Sink Current vs Output Low Voltage

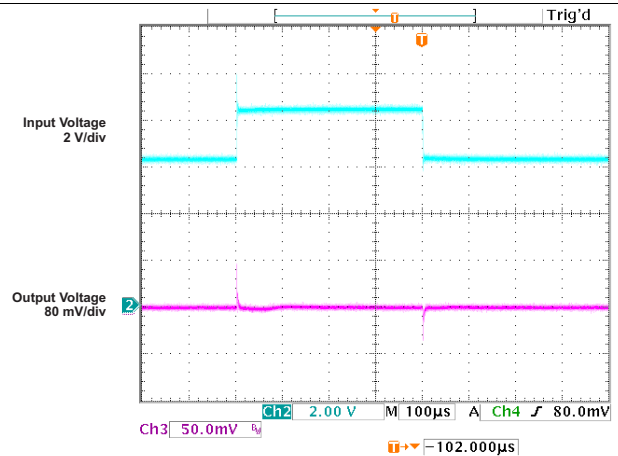

Figure 18. Line Transient Response vs Time

Typical Characteristics (continued)

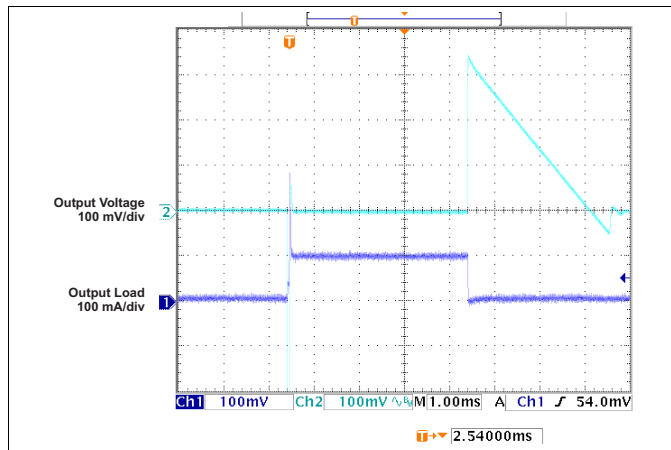

Figure 19. Load Transient Response vs Time ($V_{OUT} = 5\text{ V}$, $C_L = 1\ \mu\text{F}$)

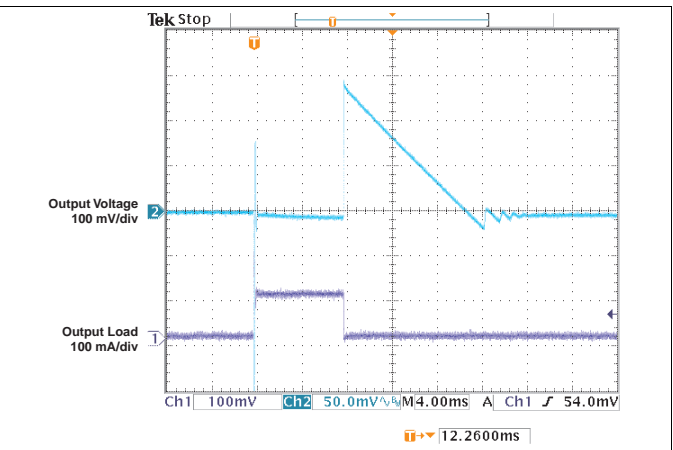

Figure 20. Load Transient Response vs Time ($V_{OUT} = 5\text{ V}$, $C_L = 10\ \mu\text{F}$)

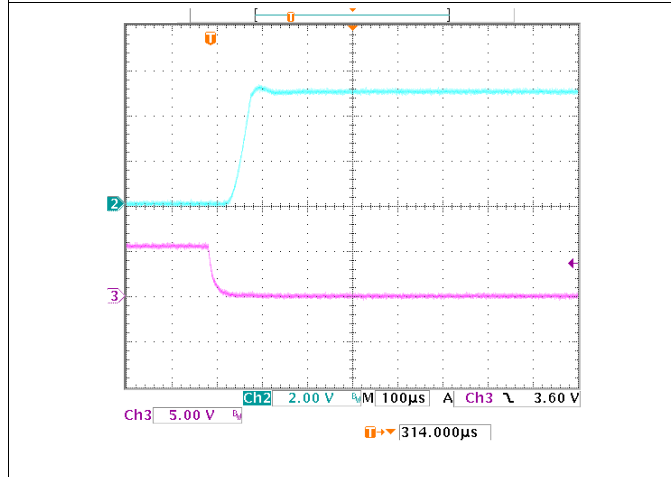

Figure 21. Enable Transient Response vs Time ($C_L = 1\ \mu\text{F}$, $I_L = 1\ \text{mA}$)

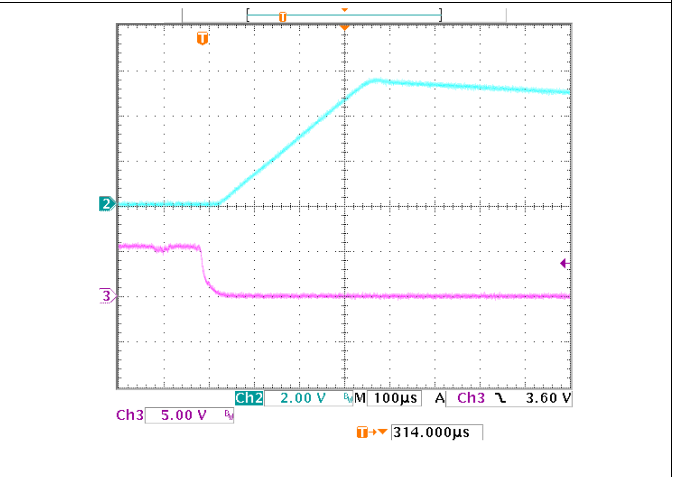

Figure 22. Enable Transient Response vs Time ($C_L = 10\ \mu\text{F}$, $I_L = 1\ \text{mA}$)

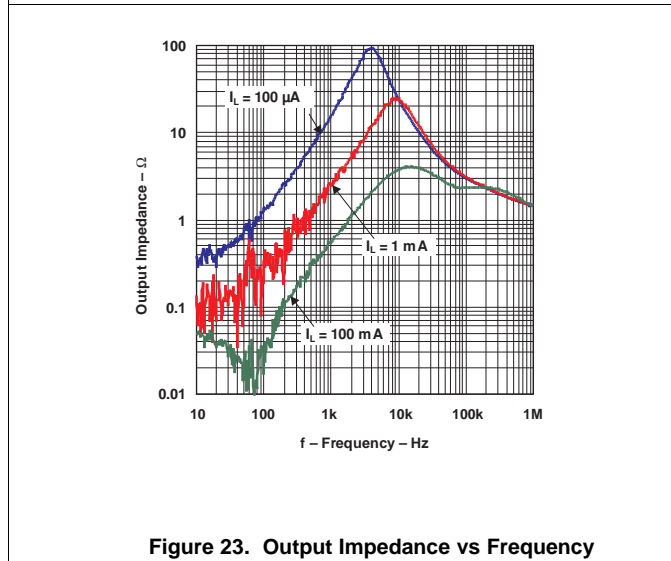

Figure 23. Output Impedance vs Frequency

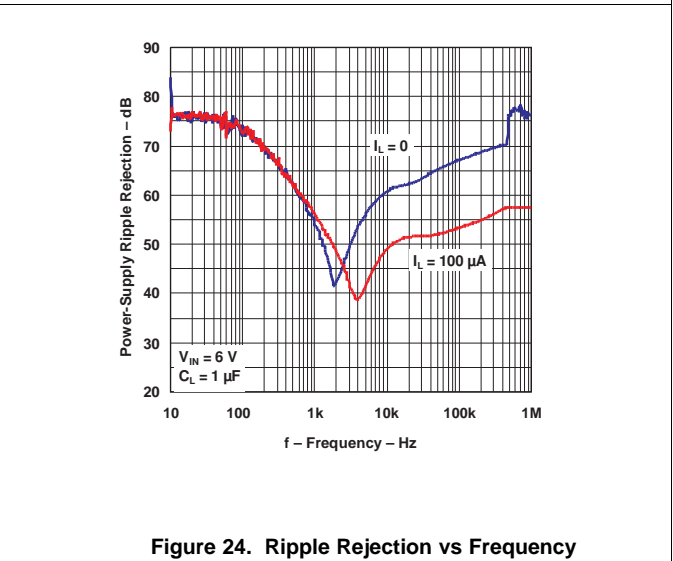

Figure 24. Ripple Rejection vs Frequency

Typical Characteristics (continued)

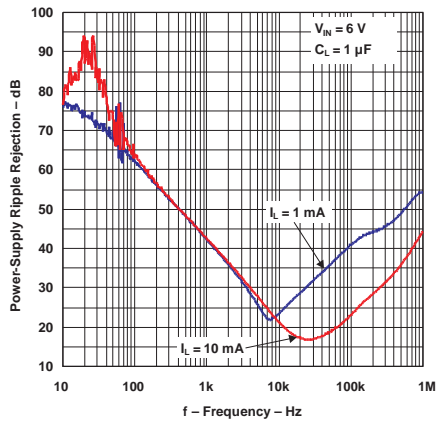

Figure 25. Ripple Rejection vs Frequency

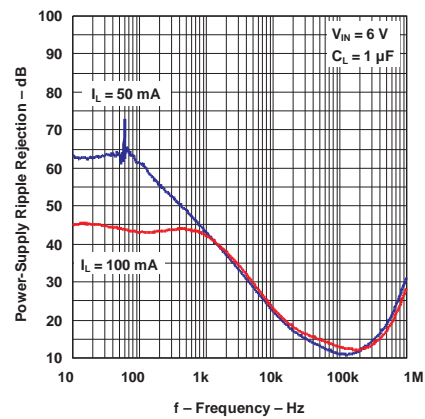

Figure 26. Ripple Rejection vs Frequency

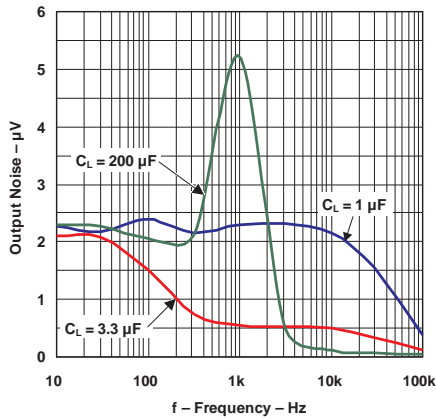

Figure 27. Output Noise vs Frequency

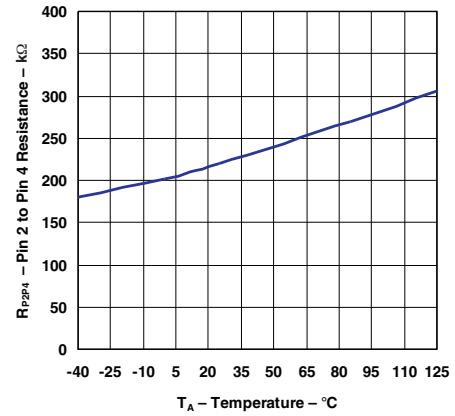

Figure 28. Divider Resistance vs Temperature

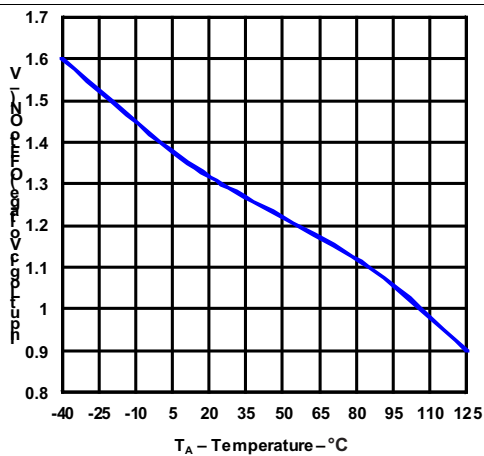

Figure 29. Shutdown Threshold Voltage (OFF to ON) vs Temperature

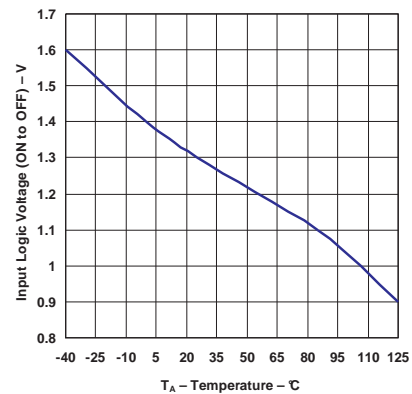

Figure 30. Shutdown Threshold Voltage (ON to OFF) vs Temperature

Typical Characteristics (continued)

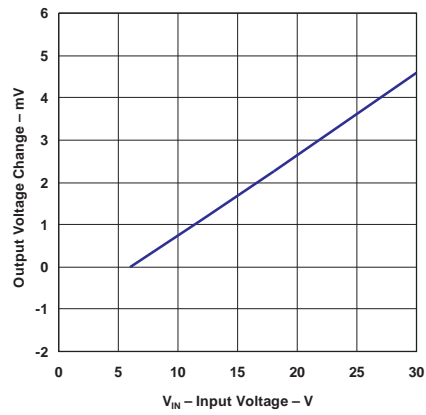

Figure 31. Line Regulation vs Input Voltage

7 Detailed Description

7.1 Overview

The LP2951-xx-Q1 devices are bipolar, low-dropout voltage regulators that can accommodate a wide input supply-voltage range of up to 30 V. The 8-pin LP2951-xx-Q1 devices are able to output either a fixed or adjustable output from the same device. By tying the OUTPUT and SENSE pins together, and the FEEDBACK and V_{TAP} pins together, the LP2951-xx-Q1 devices output a fixed 5 V, 3.3 V, or 3 V (depending on the version). Alternatively, by leaving the SENSE and V_{TAP} pins open and connecting FEEDBACK to an external resistor divider, the output can be set to any value between 1.235 V to 30 V.

The 8-pin LP2951-xx-Q1 devices also offer additional functionality that makes them particularly suitable for battery-powered applications. For example, a logic-compatible shutdown feature allows the regulator to be put in standby mode for power savings. In addition, there is a built-in supervisor reset function in which the \overline{ERROR} output goes low when V_{OUT} drops by 6% of its nominal value for whatever reasons – due to a drop in V_{IN} , current limiting, or thermal shutdown.

LP2951-xx-Q1 devices are designed to minimize all error contributions to the output voltage. With a tight output tolerance (0.5% at 25°C), a very low output voltage temperature coefficient (20 ppm typical), extremely good line and load regulation (0.3% and 0.4% typical), and remote sensing capability, the parts can be used as either low-power voltage references or 100-mA regulators.

7.2 LP2951-xx-Q1 Functional Block Diagram

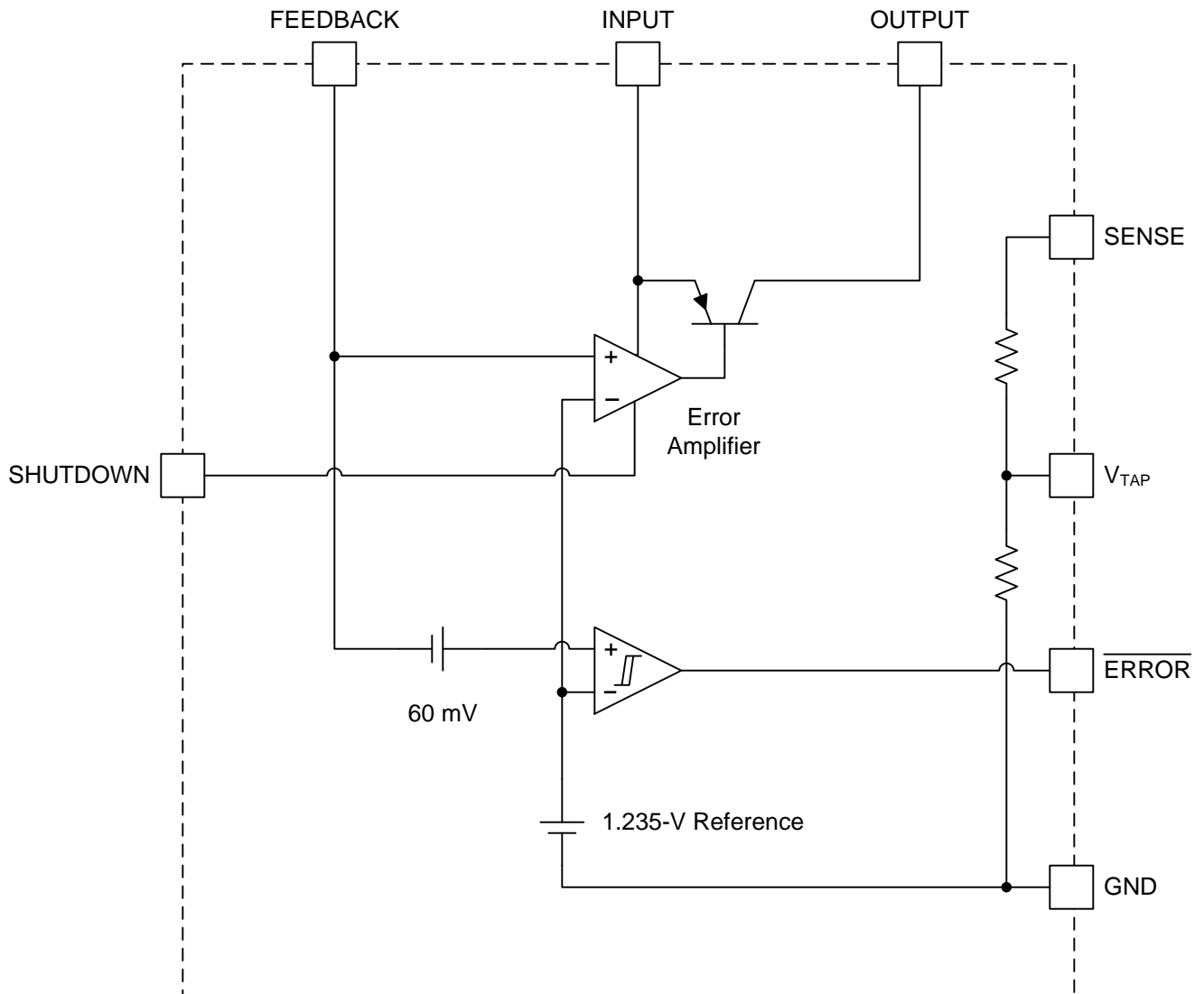

7.3 Feature Description

7.3.1 $\overline{\text{ERROR}}$ Function

The LP2951-xx-Q1 devices have a low-voltage detection comparator that outputs a logic low when the output voltage drops by $\approx 6\%$ from its nominal value, and outputs a logic high when V_{OUT} has reached $\approx 95\%$ of its nominal value. This 95% of nominal figure is obtained by dividing the built-in offset of ≈ 60 mV by the 1.235-V bandgap reference, and remains independent of the programmed output voltage. For example, the trip-point threshold ($\overline{\text{ERROR}}$ output goes high) typically is 4.75 V for a 5-V output and 11.4 V for a 12-V output. Typically, there is a hysteresis of 15 mV between the thresholds for high and low $\overline{\text{ERROR}}$ output.

A timing diagram is shown in [Figure 32](#) for $\overline{\text{ERROR}}$ vs V_{OUT} (5 V), as V_{IN} is ramped up and down. $\overline{\text{ERROR}}$ becomes valid (low) when $V_{\text{IN}} \approx 1.3$ V. When $V_{\text{IN}} \approx 5$ V, $V_{\text{OUT}} = 4.75$ V, causing $\overline{\text{ERROR}}$ to go high. Because the dropout voltage is load dependent, the output trip-point threshold is reached at different values of V_{IN} , depending on the load current. For instance, at higher load current, $\overline{\text{ERROR}}$ goes high at a slightly higher value of V_{IN} , and vice versa for lower load current. The output-voltage trip point remains at ~ 4.75 V, regardless of the load. Note that when $V_{\text{IN}} \leq 1.3$ V, the $\overline{\text{ERROR}}$ comparator output is turned off and pulled high to its pullup voltage. If V_{OUT} is used as the pullup voltage, rather than an external 5-V source, $\overline{\text{ERROR}}$ typically is ~ 1.2 V. In this condition, an equal resistor divider (10 k Ω is suitable) can be tied to $\overline{\text{ERROR}}$ to divide down the voltage to a valid logic low during any fault condition, while still enabling a logic high during normal operation.

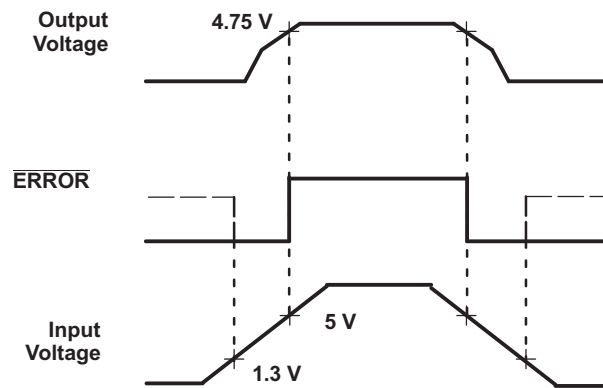

Figure 32. $\overline{\text{ERROR}}$ Output Timing

Because the $\overline{\text{ERROR}}$ comparator has an open-collector output, an external pullup resistor is required to pull the output up to V_{OUT} or another supply voltage (up to 30 V). The output of the comparator is rated to sink up to 400 μA . A suitable range of values for the pullup resistor is from 100 k Ω to 1 M Ω . If $\overline{\text{ERROR}}$ is not used, it can be left open.

Feature Description (continued)

7.3.2 Programming Output Voltage

A unique feature of the LP2951-xx-Q1 devices are their ability to output either a fixed voltage or an adjustable voltage, depending on the external pin connections. To output the internally programmed fixed voltage, tie the SENSE pin to the OUTPUT pin and the FEEDBACK pin to the V_{TAP} pin. Alternatively, a user-programmable voltage ranging from the internal 1.235-V reference to a 30-V max can be set by using an external resistor divider pair. The resistor divider is tied to V_{OUT} , and the divided-down voltage is tied directly to FEEDBACK for comparison against the internal 1.235-V reference. To satisfy the steady-state condition in which its two inputs are equal, the error amplifier drives the output to equal [Equation 1](#):

$$V_{OUT} = V_{REF} \times \left(1 + \frac{R1}{R2}\right) - I_{FB} R_1 \quad (1)$$

Where:

$V_{REF} = 1.235$ V applied across R2 (see [Figure 33](#))

$I_{FB} =$ FEEDBACK bias current, typically 20 nA

A minimum regulator output current of 1 μ A must be maintained. Thus, in an application where a no-load condition is expected (for example, CMOS circuits in standby), this 1- μ A minimum current must be provided by the resistor pair, effectively imposing a maximum value of $R2 = 1.2$ M Ω (1.235 V/1.2 M $\Omega \approx 1$ μ A).

$I_{FB} = 20$ nA introduces an error of $\approx 0.02\%$ in V_{OUT} . This can be offset by trimming R1. Alternatively, increasing the divider current makes I_{FB} less significant, thus, reducing its error contribution. For instance, using $R2 = 100$ k Ω reduces the error contribution of I_{FB} to 0.17% by increasing the divider current to ≈ 12 μ A. This increase in the divider current still is small compared to the 600- μ A typical quiescent current of the LP2951-xx-Q1 devices under no load.

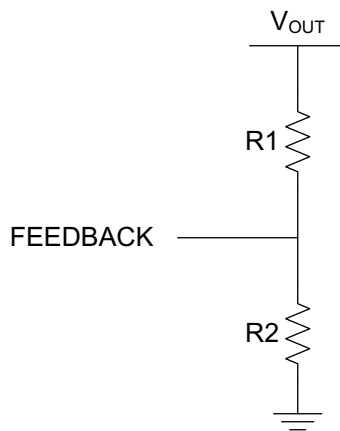

Figure 33. Adjusting the Feedback on the LP2951-xx-Q1

7.4 Device Functional Modes

7.4.1 Shutdown Mode

These devices can be placed in shutdown mode with a logic high at the SHUTDOWN pin. Return the logic level low to restore operation or tie SHUTDOWN to ground if the feature is not being used.

8 Application and Implementation

NOTE

Information in the following applications sections is not part of the TI component specification, and TI does not warrant its accuracy or completeness. TI's customers are responsible for determining suitability of components for their purposes. Customers should validate and test their design implementation to confirm system functionality.

8.1 Application Information

The LP2951-xx-Q1 devices are used as low-dropout regulators with a wide range of input voltages.

8.2 Typical Application

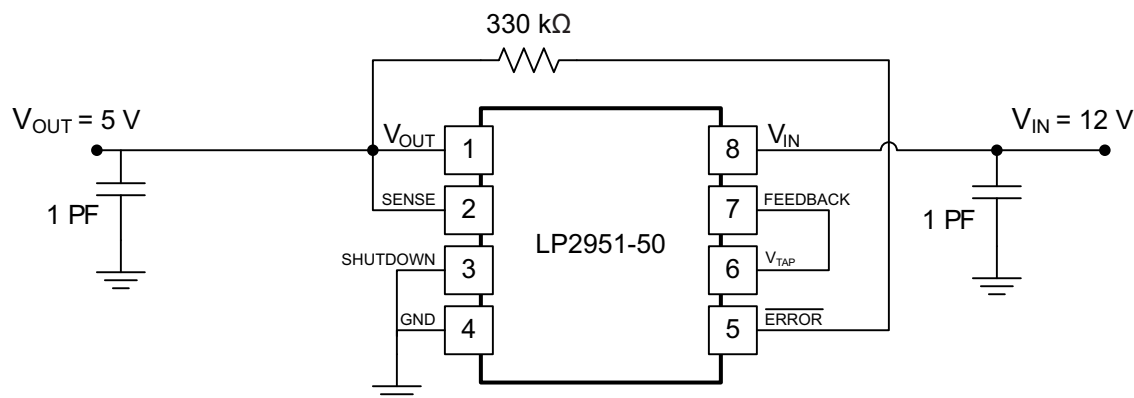

Figure 34. 12-V to 5-V Converter

8.2.1 Design Requirements

8.2.1.1 Input Capacitor (C_{IN})

A 1- μ F (tantalum, ceramic, or aluminum) electrolytic capacitor should be placed locally at the input of the LP2951-xx-Q1 device if there is, or will be, significant impedance between the ac filter capacitor and the input; for example, if a battery is used as the input or if the ac filter capacitor is located more than 10 in away. There are no ESR requirements for this capacitor, and the capacitance can be increased without limit.

8.2.1.2 Output Capacitor (C_{OUT})

As with most PNP LDOs, stability conditions require the output capacitor to have a minimum capacitance and an ESR that falls within a certain range.

Typical Application (continued)

8.2.2 Detailed Design Procedure

8.2.2.1 Capacitance Value

For $V_{OUT} \geq 5$ V, a minimum of 1 μ F is required. For lower V_{OUT} , the regulator's loop gain is running closer to unity gain and, thus, has lower phase margins. Consequently, a larger capacitance is needed for stability. For $V_{OUT} = 3$ V or 3.3 V, a minimum of 2.2 μ F is recommended. For worst case, $V_{OUT} = 1.23$ V (using the ADJ version), a minimum of 3.3 μ F is recommended. C_{OUT} can be increased without limit and only improves the regulator stability and transient response. Regardless of its value, the output capacitor should have a resonant frequency greater than 500 kHz.

The minimum capacitance values given above are for maximum load current of 100 mA. If the maximum expected load current is less than 100 mA, then lower values of C_{OUT} can be used. For instance, if $I_{OUT} < 10$ mA, then only 0.33 μ F is required for C_{OUT} . For $I_{OUT} < 1$ mA, 0.1 μ F is sufficient for stability requirements. Thus, for a worst-case condition of 100-mA load and $V_{OUT} = V_{REF} = 1.235$ V (representing the highest load current and lowest loop gain), a minimum C_{OUT} of 3.3 μ F is recommended.

For the LP2951-xx-Q1 devices, no load stability is inherent in the design — a desirable feature in CMOS circuits that are put in standby (such as RAM keep-alive applications). If the LP2951-xx-Q1 is used with external resistors to set the output voltage, a minimum load current of 1 μ A is recommended through the resistor divider.

8.2.2.2 Capacitor Types

Most tantalum or aluminum electrolytics are suitable for use at the input. Film-type capacitors also work but at higher cost. When operating at low temperature, care should be taken with aluminum electrolytics, as their electrolytes often freeze at -30° C. For this reason, solid tantalum capacitors should be used at temperatures below -25° C.

Ceramic capacitors can be used, but due to their low ESR (as low as 5 m Ω to 10 m Ω), they may not meet the minimum ESR requirement previously discussed. If a ceramic capacitor is used, a series resistor between 0.1 Ω to 2 Ω must be added to meet the minimum ESR requirement. In addition, ceramic capacitors have one glaring disadvantage that must be taken into account — a poor temperature coefficient, where the capacitance can vary significantly with temperature. For instance, a large-value ceramic capacitor (≥ 2.2 μ F) can lose more than half of its capacitance as temperature rises from 25° C to 85° C. Thus, a 2.2- μ F capacitor at 25° C drops well below the minimum C_{OUT} required for stability as ambient temperature rises. For this reason, select an output capacitor that maintains the minimum 2.2 μ F required for stability for the entire operating temperature range.

8.2.2.3 C_{BYPASS} : Noise and Stability Improvement

In the LP2951-xx-Q1 devices, an external FEEDBACK pin directly connected to the error amplifier noninverting input can allow stray capacitance to cause instability by shunting the error amplifier feedback to GND, especially at high frequencies. This is worsened if high-value external resistors are used to set the output voltage, because a high resistance allows the stray capacitance to play a more significant role; i.e., a larger RC time delay is introduced between the output of the error amplifier and its FEEDBACK input, leading to more phase shift and lower phase margin. A solution is to add a 100-pF bypass capacitor (C_{BYPASS}) between OUTPUT and FEEDBACK; because C_{BYPASS} is in parallel with R1, it lowers the impedance seen at FEEDBACK at high frequencies, in effect offsetting the effect of the parasitic capacitance by providing more feedback at higher frequencies. More feedback forces the error amplifier to work at a lower loop gain, so C_{OUT} should be increased to a minimum of 3.3 μ F to improve the regulator's phase margin.

C_{BYPASS} can be also used to reduce output noise in the LP2951-xx-Q1 devices. This bypass capacitor reduces the closed loop gain of the error amplifier at the high frequency, so noise no longer scales with the output voltage. This improvement is more noticeable with higher output voltages, where loop gain reduction is greatest. A suitable C_{BYPASS} is calculated as shown in [Equation 2](#):

$$f_{(CBYPASS)} \approx 200 \text{ Hz} \rightarrow C_{(BYPASS)} = \frac{1}{2\pi \times R1 \times 200 \text{ Hz}} \quad (2)$$

Typical Application (continued)

8.2.2.4 ESR Range

The regulator control loop relies on the ESR of the output capacitor to provide a zero to add sufficient phase margin to ensure unconditional regulator stability; this requires the closed-loop gain to intersect the open-loop response in a region where the open-loop gain rolls off at 20 dB/decade. This ensures that the phase is always less than 180° (phase margin greater than 0°) at unity gain. Thus, a minimum-maximum range for the ESR must be observed.

The upper limit of this ESR range is established by the fact that an ESR that is too high could result in the zero occurring too soon, causing the gain to roll off too slowly. This, in turn, allows a third pole to appear before unity gain and introduces enough phase shift to cause instability. This typically limits the maximum ESR to approximately 5 Ω.

Conversely, the lower limit of the ESR range is tied to the fact that an ESR that is too low shifts the zero too far out, past unity gain, which allows the gain to roll off at 40 dB/decade at unity gain, resulting in a phase shift of greater than 180°. Typically, this limits the minimum ESR to approximately 20 mΩ to 30 mΩ.

For specific ESR requirements, see [Typical Characteristics](#).

8.2.3 Application Curve

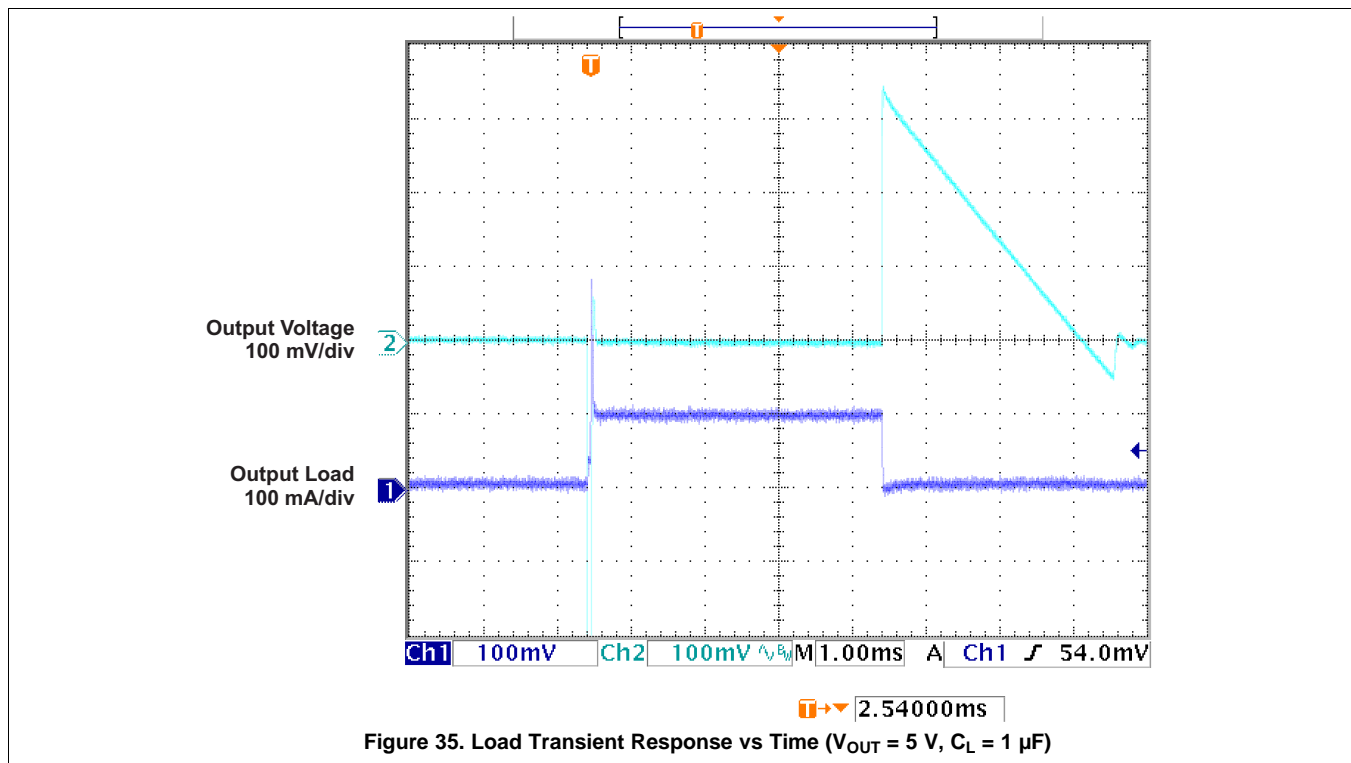

9 Power Supply Recommendations

Maximum input voltage should be limited to 30 V for proper operation. Place input and output capacitors as close to the device as possible to take advantage of their high frequency noise filtering properties.

10 Layout

10.1 Layout Guidelines

Make sure that traces on the input and outputs of the device are wide enough to handle the desired currents. For this device, the output trace will need to be larger in order to accommodate the larger available current.

Place input and output capacitors as close to the device as possible to take advantage of their high frequency noise filtering properties.

10.2 Layout Example

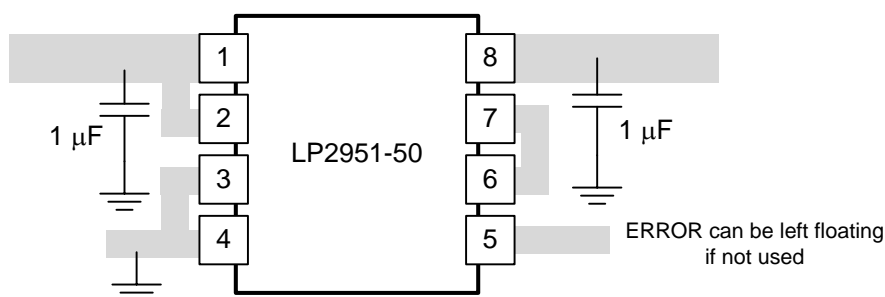

Figure 36. LP2951-xx-Q1 Layout Example (D Package)

11 Device and Documentation Support

11.1 Related Links

The table below lists quick access links. Categories include technical documents, support and community resources, tools and software, and quick access to sample or buy.

Table 1. Related Links

PARTS	PRODUCT FOLDER	SAMPLE & BUY	TECHNICAL DOCUMENTS	TOOLS & SOFTWARE	SUPPORT & COMMUNITY
LP2951-33-Q1	Click here	Click here	Click here	Click here	Click here
LP2951-50-Q1	Click here	Click here	Click here	Click here	Click here

11.2 Trademarks

All trademarks are the property of their respective owners.

11.3 Electrostatic Discharge Caution



These devices have limited built-in ESD protection. The leads should be shorted together or the device placed in conductive foam during storage or handling to prevent electrostatic damage to the MOS gates.

11.4 Glossary

[SLYZ022](#) — TI Glossary.

This glossary lists and explains terms, acronyms, and definitions.

12 Mechanical, Packaging, and Orderable Information

The following pages include mechanical, packaging, and orderable information. This information is the most current data available for the designated devices. This data is subject to change without notice and revision of this document. For browser-based versions of this data sheet, refer to the left-hand navigation.

PACKAGING INFORMATION

Orderable Device	Status (1)	Package Type	Package Drawing	Pins	Package Qty	Eco Plan (2)	Lead/Ball Finish (6)	MSL Peak Temp (3)	Op Temp (°C)	Device Marking (4/5)	Samples
LP2951-33QDRGRQ1	ACTIVE	SON	DRG	8	3000	Green (RoHS & no Sb/Br)	CU NIPDAU	Level-2-260C-1 YEAR	-40 to 125	RACQ	Samples
LP2951-50QDRGRQ1	ACTIVE	SON	DRG	8	3000	Green (RoHS & no Sb/Br)	CU NIPDAU	Level-2-260C-1 YEAR	-40 to 125	ZUFQ	Samples
LP2951-50QDRQ1	ACTIVE	SOIC	D	8	2500	Green (RoHS & no Sb/Br)	CU NIPDAU	Level-3-260C-168 HR	-40 to 125	KY515Q	Samples

(1) The marketing status values are defined as follows:

ACTIVE: Product device recommended for new designs.

LIFEBUY: TI has announced that the device will be discontinued, and a lifetime-buy period is in effect.

NRND: Not recommended for new designs. Device is in production to support existing customers, but TI does not recommend using this part in a new design.

PREVIEW: Device has been announced but is not in production. Samples may or may not be available.

OBSOLETE: TI has discontinued the production of the device.

(2) Eco Plan - The planned eco-friendly classification: Pb-Free (RoHS), Pb-Free (RoHS Exempt), or Green (RoHS & no Sb/Br) - please check <http://www.ti.com/productcontent> for the latest availability information and additional product content details.

TBD: The Pb-Free/Green conversion plan has not been defined.

Pb-Free (RoHS): TI's terms "Lead-Free" or "Pb-Free" mean semiconductor products that are compatible with the current RoHS requirements for all 6 substances, including the requirement that lead not exceed 0.1% by weight in homogeneous materials. Where designed to be soldered at high temperatures, TI Pb-Free products are suitable for use in specified lead-free processes.

Pb-Free (RoHS Exempt): This component has a RoHS exemption for either 1) lead-based flip-chip solder bumps used between the die and package, or 2) lead-based die adhesive used between the die and leadframe. The component is otherwise considered Pb-Free (RoHS compatible) as defined above.

Green (RoHS & no Sb/Br): TI defines "Green" to mean Pb-Free (RoHS compatible), and free of Bromine (Br) and Antimony (Sb) based flame retardants (Br or Sb do not exceed 0.1% by weight in homogeneous material)

(3) MSL, Peak Temp. - The Moisture Sensitivity Level rating according to the JEDEC industry standard classifications, and peak solder temperature.

(4) There may be additional marking, which relates to the logo, the lot trace code information, or the environmental category on the device.

(5) Multiple Device Markings will be inside parentheses. Only one Device Marking contained in parentheses and separated by a "~" will appear on a device. If a line is indented then it is a continuation of the previous line and the two combined represent the entire Device Marking for that device.

(6) Lead/Ball Finish - Orderable Devices may have multiple material finish options. Finish options are separated by a vertical ruled line. Lead/Ball Finish values may wrap to two lines if the finish value exceeds the maximum column width.

Important Information and Disclaimer: The information provided on this page represents TI's knowledge and belief as of the date that it is provided. TI bases its knowledge and belief on information provided by third parties, and makes no representation or warranty as to the accuracy of such information. Efforts are underway to better integrate information from third parties. TI has taken and

continues to take reasonable steps to provide representative and accurate information but may not have conducted destructive testing or chemical analysis on incoming materials and chemicals. TI and TI suppliers consider certain information to be proprietary, and thus CAS numbers and other limited information may not be available for release.

In no event shall TI's liability arising out of such information exceed the total purchase price of the TI part(s) at issue in this document sold by TI to Customer on an annual basis.

OTHER QUALIFIED VERSIONS OF LP2951-33-Q1, LP2951-50-Q1 :

- Catalog: [LP2951-33](#), [LP2951-50](#)

NOTE: Qualified Version Definitions:

- Catalog - TI's standard catalog product

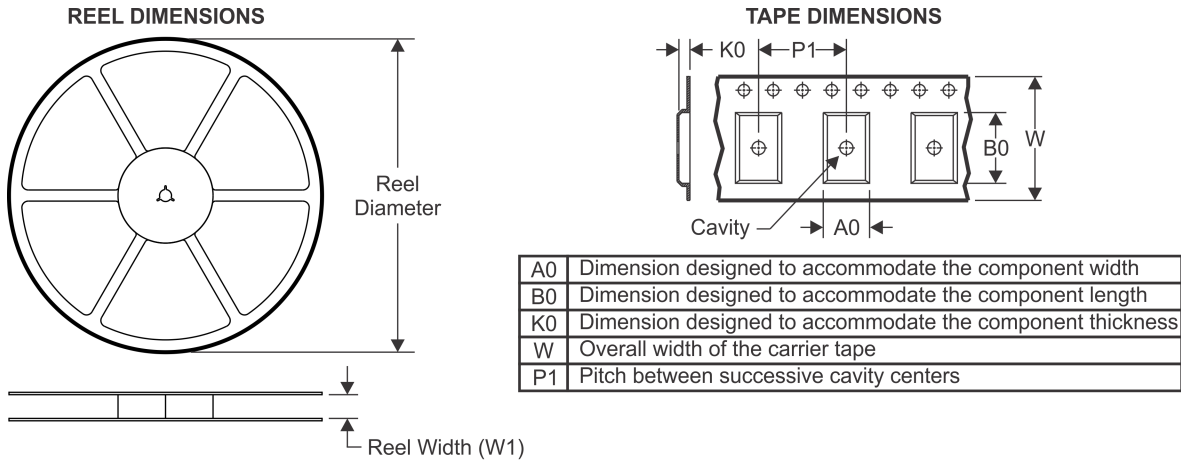
TAPE AND REEL INFORMATION

QUADRANT ASSIGNMENTS FOR PIN 1 ORIENTATION IN TAPE

*All dimensions are nominal

Device	Package Type	Package Drawing	Pins	SPQ	Reel Diameter (mm)	Reel Width W1 (mm)	A0 (mm)	B0 (mm)	K0 (mm)	P1 (mm)	W (mm)	Pin1 Quadrant
LP2951-33QDRGRQ1	SON	DRG	8	3000	330.0	12.4	3.3	3.3	1.1	8.0	12.0	Q2
LP2951-50QDRGRQ1	SON	DRG	8	3000	330.0	12.4	3.3	3.3	1.1	8.0	12.0	Q2

TAPE AND REEL BOX DIMENSIONS



*All dimensions are nominal

Device	Package Type	Package Drawing	Pins	SPQ	Length (mm)	Width (mm)	Height (mm)
LP2951-33QDRGRQ1	SON	DRG	8	3000	367.0	367.0	35.0
LP2951-50QDRGRQ1	SON	DRG	8	3000	367.0	367.0	35.0

DRG (S-PWSON-N8)

PLASTIC SMALL OUTLINE NO-LEAD

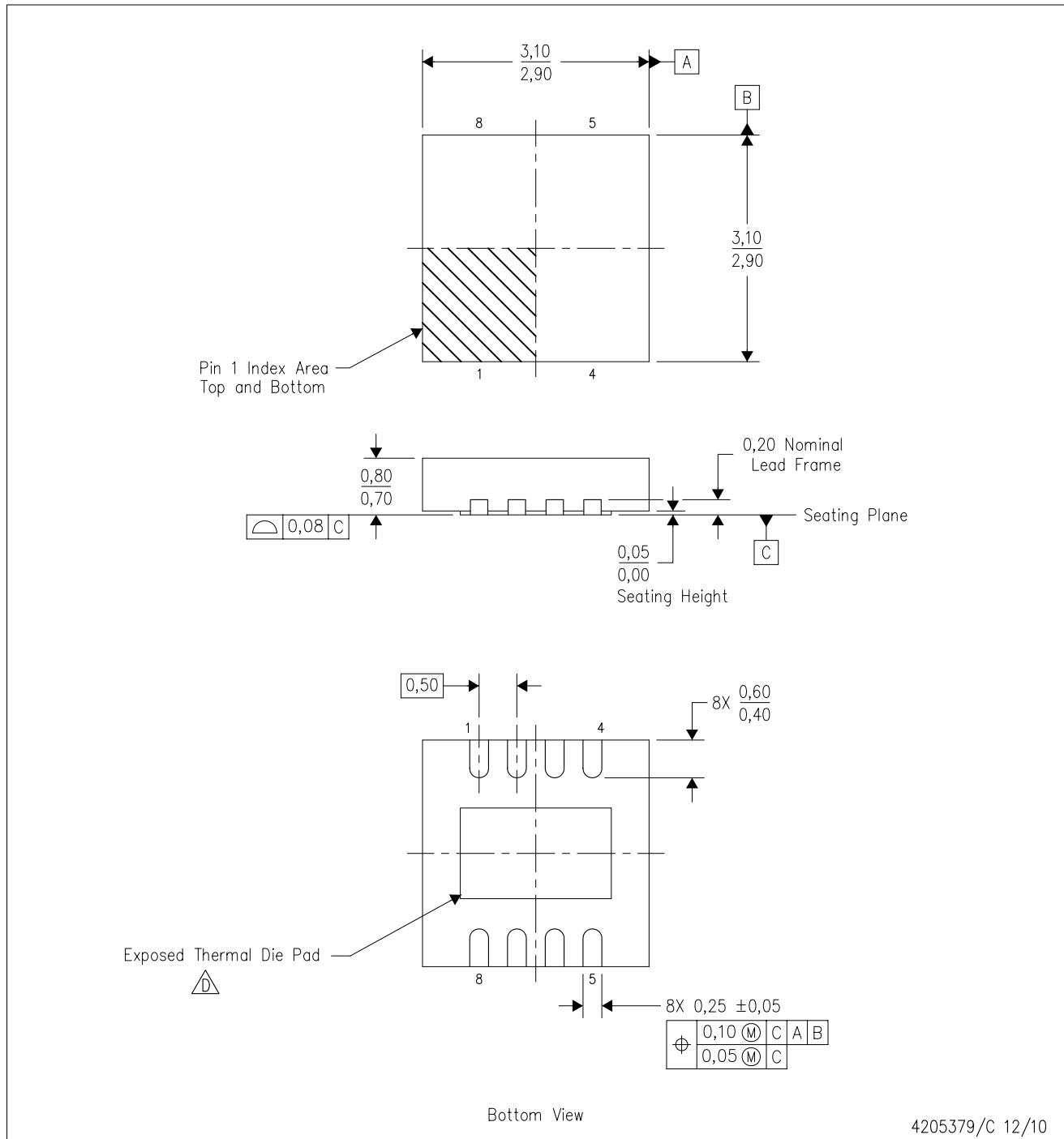

- NOTES:
- A. All linear dimensions are in millimeters. Dimensioning and tolerancing per ASME Y14.5M-1994.
 - B. This drawing is subject to change without notice.
 - C. SON (Small Outline No-Lead) package configuration.
 - D. The package thermal pad must be soldered to the board for thermal and mechanical performance. See the Product Data Sheet for details regarding the exposed thermal pad dimensions.
 - E. JEDEC MO-229 package registration pending.

THERMAL INFORMATION

This package incorporates an exposed thermal pad that is designed to be attached directly to an external heatsink. The thermal pad must be soldered directly to the printed circuit board (PCB). After soldering, the PCB can be used as a heatsink. In addition, through the use of thermal vias, the thermal pad can be attached directly to the appropriate copper plane shown in the electrical schematic for the device, or alternatively, can be attached to a special heatsink structure designed into the PCB. This design optimizes the heat transfer from the integrated circuit (IC).

For information on the Quad Flatpack No-Lead (QFN) package and its advantages, refer to Application Report, QFN/SON PCB Attachment, Texas Instruments Literature No. SLUA271. This document is available at www.ti.com.

The exposed thermal pad dimensions for this package are shown in the following illustration.

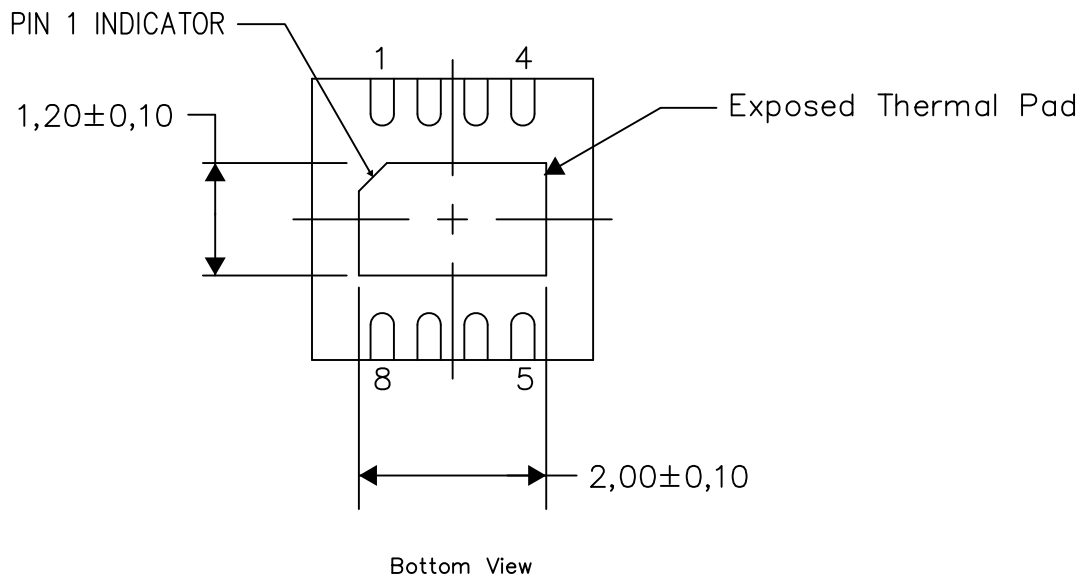

Exposed Thermal Pad Dimensions

4206881-2/H 12/13

NOTE: All linear dimensions are in millimeters

DRG (S-PWSON-N8)

PLASTIC SMALL OUTLINE NO-LEAD

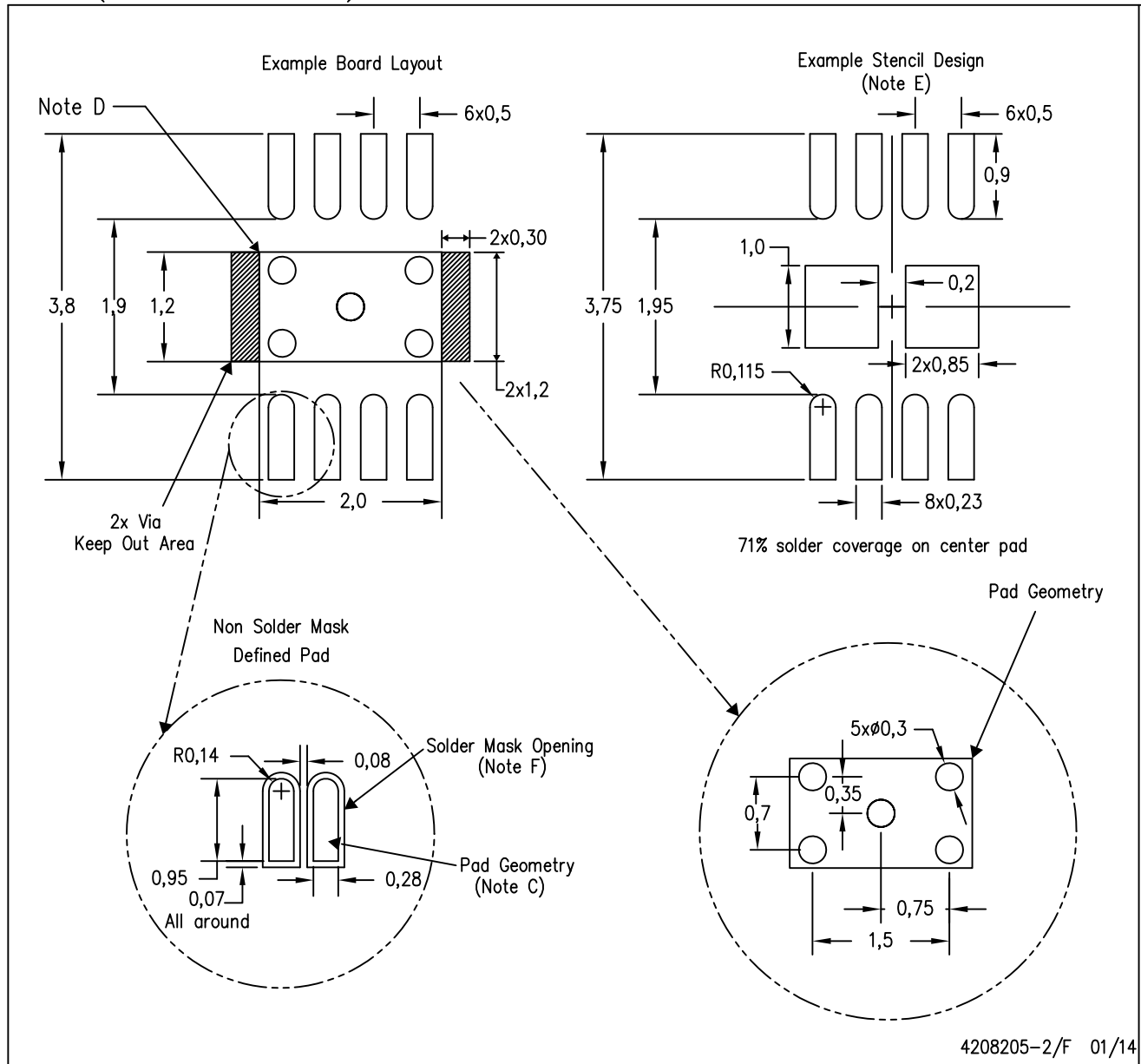

- NOTES:
- All linear dimensions are in millimeters.
 - This drawing is subject to change without notice.
 - Publication IPC-SM-782 is recommended for alternate designs.
 - This package is designed to be soldered to a thermal pad on the board. Refer to Application Note, Quad Flat-Pack Packages, Texas Instruments Literature No. SLUA271, and also the Product Data Sheets for specific thermal information, via requirements, and recommended board layout. These documents are available at www.ti.com <<http://www.ti.com>>.
 - Laser cutting apertures with trapezoidal walls and also rounding corners will offer better paste release. Customers should contact their board assembly site for stencil design recommendations. Refer to IPC 7525 for stencil design considerations.
 - Customers should contact their board fabrication site for minimum solder mask web tolerances between signal pads.

D (R-PDSO-G8)

PLASTIC SMALL OUTLINE



4211283-2/E 08/12

- NOTES:
- A. All linear dimensions are in millimeters.
 - B. This drawing is subject to change without notice.
 - C. Publication IPC-7351 is recommended for alternate designs.
 - D. Laser cutting apertures with trapezoidal walls and also rounding corners will offer better paste release. Customers should contact their board assembly site for stencil design recommendations. Refer to IPC-7525 for other stencil recommendations.
 - E. Customers should contact their board fabrication site for solder mask tolerances between and around signal pads.

IMPORTANT NOTICE

Texas Instruments Incorporated and its subsidiaries (TI) reserve the right to make corrections, enhancements, improvements and other changes to its semiconductor products and services per JESD46, latest issue, and to discontinue any product or service per JESD48, latest issue. Buyers should obtain the latest relevant information before placing orders and should verify that such information is current and complete. All semiconductor products (also referred to herein as "components") are sold subject to TI's terms and conditions of sale supplied at the time of order acknowledgment.

TI warrants performance of its components to the specifications applicable at the time of sale, in accordance with the warranty in TI's terms and conditions of sale of semiconductor products. Testing and other quality control techniques are used to the extent TI deems necessary to support this warranty. Except where mandated by applicable law, testing of all parameters of each component is not necessarily performed.

TI assumes no liability for applications assistance or the design of Buyers' products. Buyers are responsible for their products and applications using TI components. To minimize the risks associated with Buyers' products and applications, Buyers should provide adequate design and operating safeguards.

TI does not warrant or represent that any license, either express or implied, is granted under any patent right, copyright, mask work right, or other intellectual property right relating to any combination, machine, or process in which TI components or services are used. Information published by TI regarding third-party products or services does not constitute a license to use such products or services or a warranty or endorsement thereof. Use of such information may require a license from a third party under the patents or other intellectual property of the third party, or a license from TI under the patents or other intellectual property of TI.

Reproduction of significant portions of TI information in TI data books or data sheets is permissible only if reproduction is without alteration and is accompanied by all associated warranties, conditions, limitations, and notices. TI is not responsible or liable for such altered documentation. Information of third parties may be subject to additional restrictions.

Resale of TI components or services with statements different from or beyond the parameters stated by TI for that component or service voids all express and any implied warranties for the associated TI component or service and is an unfair and deceptive business practice. TI is not responsible or liable for any such statements.

Buyer acknowledges and agrees that it is solely responsible for compliance with all legal, regulatory and safety-related requirements concerning its products, and any use of TI components in its applications, notwithstanding any applications-related information or support that may be provided by TI. Buyer represents and agrees that it has all the necessary expertise to create and implement safeguards which anticipate dangerous consequences of failures, monitor failures and their consequences, lessen the likelihood of failures that might cause harm and take appropriate remedial actions. Buyer will fully indemnify TI and its representatives against any damages arising out of the use of any TI components in safety-critical applications.

In some cases, TI components may be promoted specifically to facilitate safety-related applications. With such components, TI's goal is to help enable customers to design and create their own end-product solutions that meet applicable functional safety standards and requirements. Nonetheless, such components are subject to these terms.

No TI components are authorized for use in FDA Class III (or similar life-critical medical equipment) unless authorized officers of the parties have executed a special agreement specifically governing such use.

Only those TI components which TI has specifically designated as military grade or "enhanced plastic" are designed and intended for use in military/aerospace applications or environments. Buyer acknowledges and agrees that any military or aerospace use of TI components which have **not** been so designated is solely at the Buyer's risk, and that Buyer is solely responsible for compliance with all legal and regulatory requirements in connection with such use.

TI has specifically designated certain components as meeting ISO/TS16949 requirements, mainly for automotive use. In any case of use of non-designated products, TI will not be responsible for any failure to meet ISO/TS16949.

Products

Audio	www.ti.com/audio
Amplifiers	amplifier.ti.com
Data Converters	dataconverter.ti.com
DLP® Products	www.dlp.com
DSP	dsp.ti.com
Clocks and Timers	www.ti.com/clocks
Interface	interface.ti.com
Logic	logic.ti.com
Power Mgmt	power.ti.com
Microcontrollers	microcontroller.ti.com
RFID	www.ti-rfid.com
OMAP Applications Processors	www.ti.com/omap
Wireless Connectivity	www.ti.com/wirelessconnectivity

Applications

Automotive and Transportation	www.ti.com/automotive
Communications and Telecom	www.ti.com/communications
Computers and Peripherals	www.ti.com/computers
Consumer Electronics	www.ti.com/consumer-apps
Energy and Lighting	www.ti.com/energy
Industrial	www.ti.com/industrial
Medical	www.ti.com/medical
Security	www.ti.com/security
Space, Avionics and Defense	www.ti.com/space-avionics-defense
Video and Imaging	www.ti.com/video

TI E2E Community

e2e.ti.com