

LP38511-ADJ 800mA Fast-Transient Response Adjustable Low-Dropout Linear Voltage Regulator

 Check for Samples: [LP38511-ADJ](#)

FEATURES

- 2.25V to 5.5V Input Voltage Range
- Adjustable Output Voltage Range of 0.5V to 3.3V
- 800mA Output Load Current
- $\pm 2.0\%$ Accuracy over Line, Load, and Full-Temperature Range from -40°C to $+125^{\circ}\text{C}$
- Stable with Tiny 10 μF Ceramic Capacitors
- Enable Pin
- Typically Less than 1 μA of Ground Pin Current with Enable Pin Low
- 25dB of PSRR at 100 kHz
- Over-Temperature and Over-Current Protection
- 8-Pin SO PowerPad and 5-Pin PFM Surface Mount Packages

APPLICATIONS

- Digital Core ASICs, FPGAs, and DSPs
- Servers
- Routers and Switches
- Base Stations
- Storage Area Networks
- DDR2 Memory

DESCRIPTION

The LP38511-ADJ Fast-Transient Response Low-Dropout Voltage Regulator offers the highest-performance in meeting AC and DC accuracy requirements for powering Digital Cores. The LP38511-ADJ uses a proprietary control loop that enables extremely fast response to change in line conditions and load demands. Output Voltage DC accuracy is specified at 2.5% over line, load and full temperature range from -40°C to $+125^{\circ}\text{C}$. The LP38511-ADJ is designed for inputs from the 2.5V, 3.3V, and 5.0V rail, is stable with 10 μF ceramic capacitors, and has an adjustable output voltage. The LP38511-ADJ provides excellent transient performance to meet the demand of high performance digital core ASICs, DSPs, and FPGAs found in highly-intensive applications such as servers, routers/switches, and base stations.

Typical Application Circuit

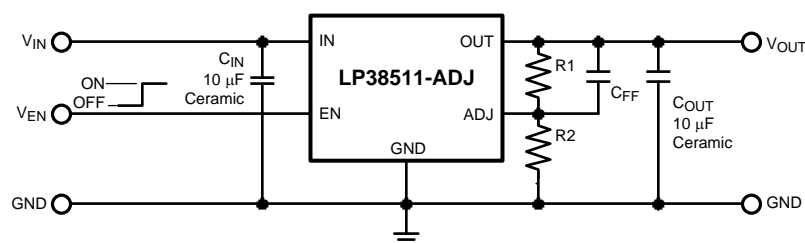

Please be aware that an important notice concerning availability, standard warranty, and use in critical applications of Texas Instruments semiconductor products and disclaimers thereto appears at the end of this data sheet.

All trademarks are the property of their respective owners.

Connection Diagram

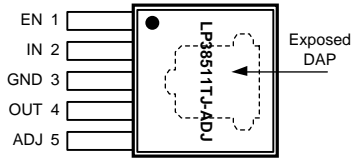

Figure 1. 5-Pin PFM, Top View
See NDQ0005A Package

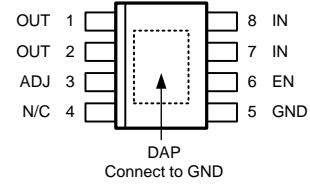

Figure 2. 8-Pin SO PowerPad, Top View
See DDA0008A Package

Pin Descriptions for PFM Package

Pin #	Pin Name	Function
1	EN	Enable. Pull high to enable the output, low to disable the output. This pin has no internal bias and must be tied to the input voltage, or actively driven.
2	IN	Input Supply Pin.
3	GND	Ground
4	OUT	Regulated Output Voltage Pin.
5	ADJ	The feedback to the internal Error Amplifier to set the output voltage.
DAP	DAP	The PFM DAP is used as a thermal connection to remove heat from the device to an external heat-sink in the form of the copper area on the printed circuit board. The DAP is physically connected to backside of the die. The DAP is internally connected to device ground. The DAP should be soldered to the Ground Plane copper.

Pin Descriptions for SO PowerPad Package

Pin #	Pin Name	Function
1, 2	OUT	Regulated Output Voltage Pins. Pins 1 and 2 share current and must be connected together.
3	ADJ	The feedback to the internal Error Amplifier to set the output voltage.
4	N/C	No internal connection
5	GND	Ground
6	EN	Enable. Pull high to enable the output, low to disable the output. This pin has no internal bias and must be tied to the input voltage, or actively driven.
7, 8	IN	Input Supply Pin. Pins 7 and 8 share current and must be connected together.
DAP	DAP	The SO PowerPad DAP is used as a thermal connection to remove heat from the device to an external heat-sink in the form of the copper area on the printed circuit board. The DAP is physically connected to backside of the die, but is not internally connected to device ground. The DAP should be soldered to the Ground Plane copper.



These devices have limited built-in ESD protection. The leads should be shorted together or the device placed in conductive foam during storage or handling to prevent electrostatic damage to the MOS gates.

Absolute Maximum Ratings⁽¹⁾⁽²⁾

Storage Temperature Range		-65°C to +150°C
Soldering Temperature ⁽³⁾	PFM	260°C, 10s
	SO PowerPad	260°C, 10s
ESD Rating ⁽⁴⁾		±2 kV
Power Dissipation ⁽⁵⁾		Internally Limited
Input Pin Voltage (Survival)		-0.3V to +6.0V
Enable Pin Voltage (Survival)		-0.3V to +6.0V
Output Pin Voltage (Survival)		-0.3V to +6.0V
ADJ Pin Voltage (Survival)		-0.3V to +6.0V
I _{OUT} (Survival)		Internally Limited

- (1) Absolute Maximum Ratings indicate limits beyond which damage to the device may occur. Operating Ratings indicate conditions for which the device is intended to be functional, but does not ensure specific performance limits. For ensured specifications and conditions, see the Electrical Characteristics.
- (2) If Military/Aerospace specified devices are required, please contact the Texas Instruments Sales Office/ Distributors for availability and specifications.
- (3) Refer to JEDEC J-STD-020C for surface mount device (SMD) package reflow profiles and conditions. Unless otherwise stated, the temperatures and times are for Sn-Pb (STD) only.
- (4) The human body model is a 100 pF capacitor discharged through a 1.5 kΩ resistor into each pin. Test method is per JESD22-A114.
- (5) Device operation must be evaluated, and derated as needed, based on ambient temperature (T_A), power dissipation (P_D), maximum allowable operating junction temperature (T_{J(MAX)}), and package thermal resistance (θ_{JA}). The typical θ_{JA} ratings given are worst case based on minimum land area on two-layer PCB (EIA/JESD51-3). See [POWER DISSIPATION/HEAT-SINKING](#) for details.

Operating Ratings⁽¹⁾

Input Supply Voltage, V _{IN}	2.25V to 5.5V
Output Voltage, V _{OUT}	V _{ADJ} to 5V
Enable Input Voltage, V _{EN}	0.0V to 5.5V
Output Current (DC)	1 mA to 800 mA
Junction Temperature ⁽²⁾	-40°C to +125°C

- (1) Absolute Maximum Ratings indicate limits beyond which damage to the device may occur. Operating Ratings indicate conditions for which the device is intended to be functional, but does not ensure specific performance limits. For ensured specifications and conditions, see the Electrical Characteristics.
- (2) Device operation must be evaluated, and derated as needed, based on ambient temperature (T_A), power dissipation (P_D), maximum allowable operating junction temperature (T_{J(MAX)}), and package thermal resistance (θ_{JA}). The typical θ_{JA} ratings given are worst case based on minimum land area on two-layer PCB (EIA/JESD51-3). See [POWER DISSIPATION/HEAT-SINKING](#) for details.

Electrical Characteristics

Unless otherwise specified: V_{IN} = 2.50V, V_{OUT} = V_{ADJ}, I_{OUT} = 10 mA, C_{IN} = 10 μF, C_{OUT} = 10 μF, V_{EN} = 2.0V. Limits in standard type are for T_J = 25°C only; limits in **boldface type** apply over the junction temperature (T_J) range of -40°C to +125°C. Minimum and Maximum limits are ensured through test, design, or statistical correlation. Typical values represent the most likely parametric norm at T_J = 25°C, and are provided for reference purposes only.

Symbol	Parameter	Conditions	Min	Typ	Max	Units
V _{ADJ}	V _{ADJ} Accuracy ⁽¹⁾	2.25V ≤ V _{IN} ≤ 5.5V 10 mA ≤ I _{OUT} ≤ 800 mA	495.0 490.0	500.	505.0 510.0	mV
I _{ADJ}	ADJ Pin Bias Current	2.25V ≤ V _{IN} ≤ 5.5V	-	1	-	nA
ΔV _{ADJ} /ΔV _{IN}	V _{ADJ} Line Regulation ⁽²⁾⁽¹⁾	2.25V ≤ V _{IN} ≤ 5.5V	-	0.03 0.06	-	%/V
ΔV _{ADJ} /ΔI _{OUT}	V _{ADJ} Load Regulation ⁽³⁾⁽¹⁾	10 mA ≤ I _{OUT} ≤ 800 mA	-	0.10 0.20	-	%/A
V _{DO}	Dropout Voltage ⁽⁴⁾	I _{OUT} = 800 mA	-	-	260	mV

- (1) The line and load regulation specification contains only the typical number. However, the limits for line and load regulation are included in the output voltage tolerance specification.
- (2) Line regulation is defined as the change in V_{ADJ} from the nominal value due to change in the voltage at the input.
- (3) Load regulation is defined as the change in V_{ADJ} from the nominal value due to change in the load current at the output.
- (4) Dropout voltage (V_{DO}) is typically defined as the input to output voltage differential (V_{IN} - V_{OUT}) where the input voltage is low enough to cause the output voltage to drop 2%. For the LP38511-ADJ, the minimum operating voltage of 2.25V is the limiting factor when the programmed output voltage is less than typically 1.80V.

Electrical Characteristics (continued)

Unless otherwise specified: $V_{IN} = 2.50V$, $V_{OUT} = V_{ADJ}$, $I_{OUT} = 10\text{ mA}$, $C_{IN} = 10\text{ }\mu\text{F}$, $C_{OUT} = 10\text{ }\mu\text{F}$, $V_{EN} = 2.0V$. Limits in standard type are for $T_J = 25^\circ\text{C}$ only; limits in **boldface type** apply over the junction temperature (T_J) range of -40°C to $+125^\circ\text{C}$. Minimum and Maximum limits are ensured through test, design, or statistical correlation. Typical values represent the most likely parametric norm at $T_J = 25^\circ\text{C}$, and are provided for reference purposes only.

Symbol	Parameter	Conditions	Min	Typ	Max	Units
I_{GND}	Ground Pin Current, Output Enabled	$I_{OUT} = 10\text{ mA}$	-	7.5	11 12	mA
		$I_{OUT} = 800\text{ mA}$	-	9	11 13	
	Ground Pin Current, Output Disabled	$V_{EN} = 0.50V$	-	0.1	3.5 12	μA
I_{SC}	Short Circuit Current	$V_{OUT} = 0V$	-	1.5	-	A
Enable Input						
$V_{EN(ON)}$	Enable ON Voltage Threshold	V_{EN} rising from $<0.5V$ until $V_{OUT} = \text{ON}$	0.90 0.80	1.20	1.50 1.60	V
$V_{EN(OFF)}$	Enable OFF Voltage Threshold	V_{EN} falling from 1.6V until $V_{OUT} = \text{OFF}$	0.60 0.50	1.00	1.40 1.50	V
$V_{EN(HYS)}$	Enable Voltage Hysteresis	$V_{EN(ON)} - V_{EN(OFF)}$	-	200	-	mV
I_{EN}	Enable Pin Current	$V_{EN} = V_{IN}$	-	1	-	nA
		$V_{EN} = 0V$	-	-1	-	
$t_{d(OFF)}$	Turn-off delay	Time from $V_{EN} < V_{EN(OFF)}$ to $V_{OUT} = \text{OFF}$, $I_{LOAD} = 800\text{ mA}$	-	1	-	μs
$t_{d(ON)}$	Turn-on delay	Time from $V_{EN} > V_{EN(ON)}$ to $V_{OUT} = \text{ON}$, $I_{LOAD} = 800\text{ mA}$	-	25	-	
AC Parameters						
PSRR	Ripple Rejection	$V_{IN} = 2.5V$ $f = 120\text{Hz}$	-	73	-	dB
		$V_{IN} = 2.5V$ $f = 1\text{ kHz}$	-	70	-	
$\rho_n(f)$	Output Noise Density	$f = 120\text{Hz}$	-	0.4	-	$\mu\text{V}/\sqrt{\text{Hz}}$
e_n	Output Noise Voltage	$\text{BW} = 10\text{Hz} - 100\text{kHz}$	-	25	-	μV_{RMS}
Thermal Characteristics						
T_{SD}	Thermal Shutdown	T_J rising	-	165	-	$^\circ\text{C}$
ΔT_{SD}	Thermal Shutdown Hysteresis	T_J falling from T_{SD}	-	10	-	
θ_{J-A}	Thermal Resistance Junction to Ambient ⁽⁵⁾	SO PowerPad	-	168	-	$^\circ\text{C}/\text{W}$
		PFM	-	67	-	
θ_{J-C}	Thermal Resistance Junction to Case	SO PowerPad	-	11	-	$^\circ\text{C}/\text{W}$
		PFM	-	2	-	

- (5) Device operation must be evaluated, and derated as needed, based on ambient temperature (T_A), power dissipation (P_D), maximum allowable operating junction temperature ($T_{J(MAX)}$), and package thermal resistance (θ_{JA}). The typical θ_{JA} ratings given are worst case based on minimum land area on two-layer PCB (EIA/JESD51-3). See [POWER DISSIPATION/HEAT-SINKING](#) for details.

Typical Performance Characteristics

Unless otherwise specified: $T_J = 25^\circ\text{C}$, $V_{IN} = 2.50\text{V}$, $V_{OUT} = V_{ADJ}$, $V_{EN} = 2.0\text{V}$, $C_{IN} = 10\ \mu\text{F}$, $C_{OUT} = 10\ \mu\text{F}$, $I_{OUT} = 10\ \text{mA}$.

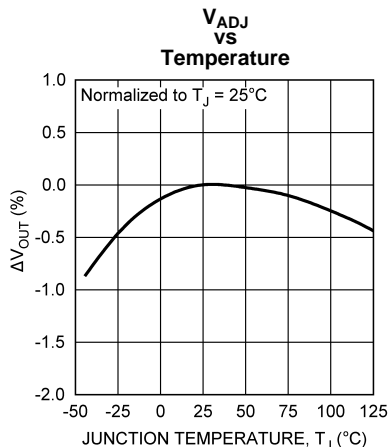

Figure 3.

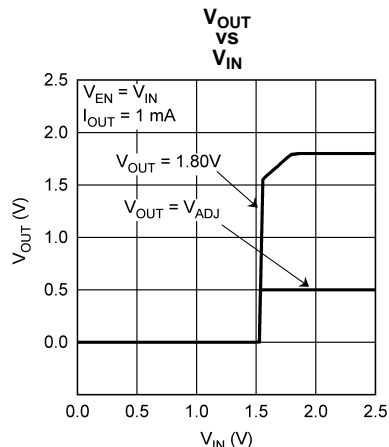

Figure 4.

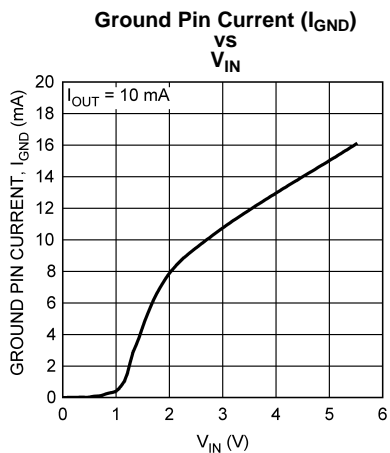

Figure 5.

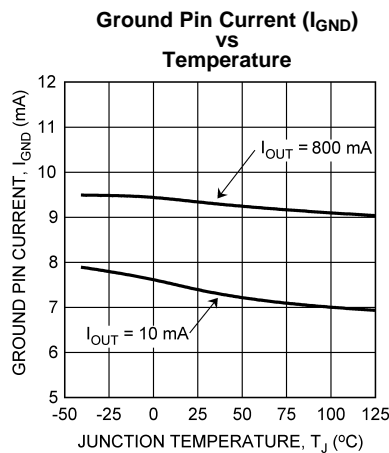

Figure 6.

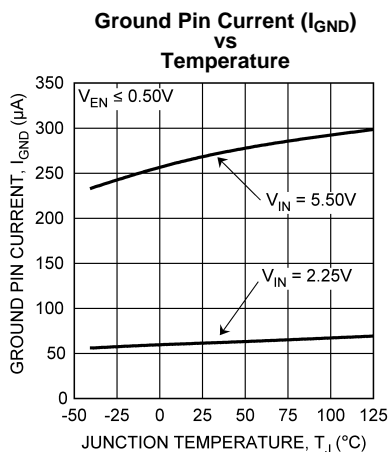

Figure 7.

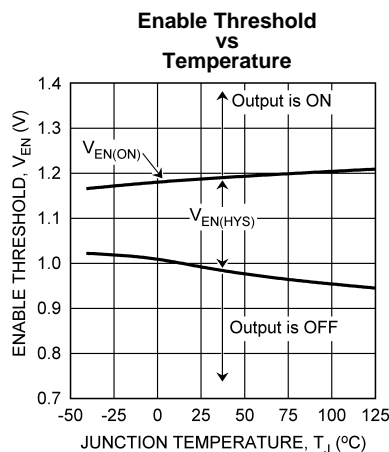

Figure 8.

Typical Performance Characteristics (continued)

Unless otherwise specified: $T_J = 25^\circ\text{C}$, $V_{IN} = 2.50\text{V}$, $V_{OUT} = V_{ADJ}$, $V_{EN} = 2.0\text{V}$, $C_{IN} = 10\ \mu\text{F}$, $C_{OUT} = 10\ \mu\text{F}$, $I_{OUT} = 10\ \text{mA}$.

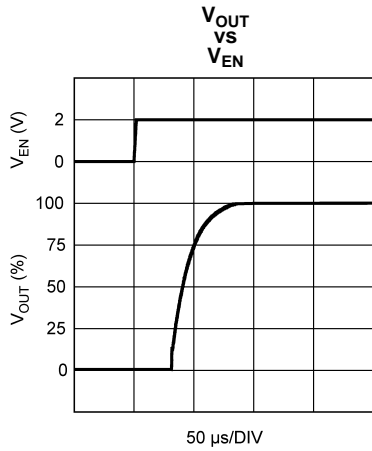

Figure 9.

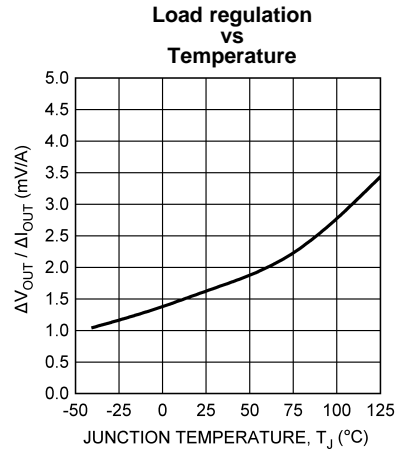

Figure 10.

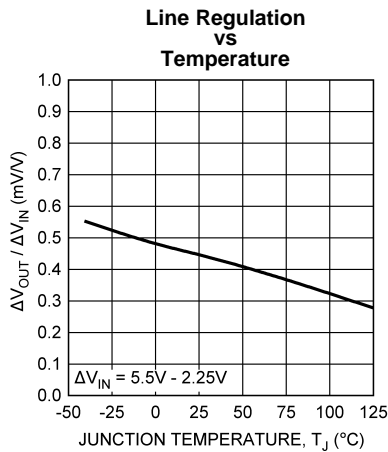

Figure 11.

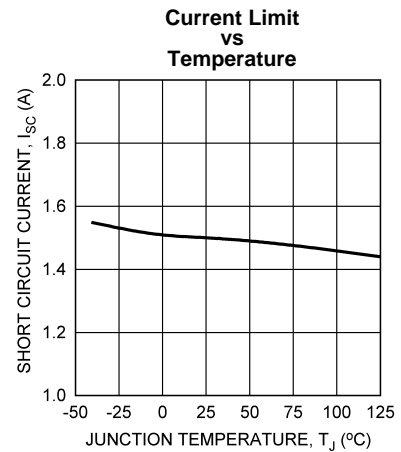

Figure 12.

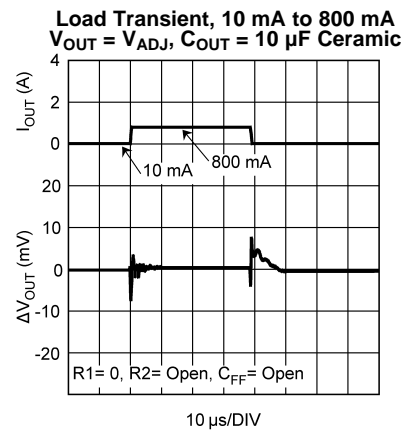

Figure 13.

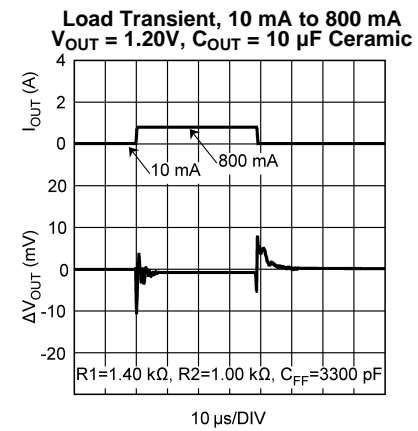

Figure 14.

Typical Performance Characteristics (continued)

Unless otherwise specified: $T_J = 25^\circ\text{C}$, $V_{IN} = 2.50\text{V}$, $V_{OUT} = V_{ADJ}$, $V_{EN} = 2.0\text{V}$, $C_{IN} = 10\ \mu\text{F}$, $C_{OUT} = 10\ \mu\text{F}$, $I_{OUT} = 10\ \text{mA}$.

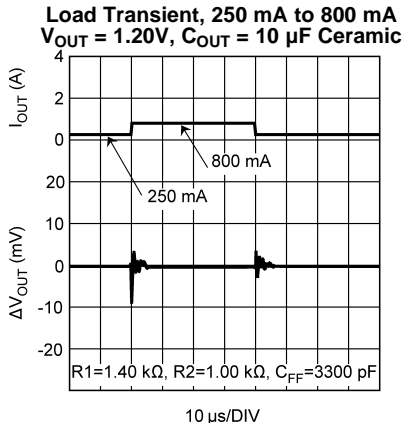

Figure 15.

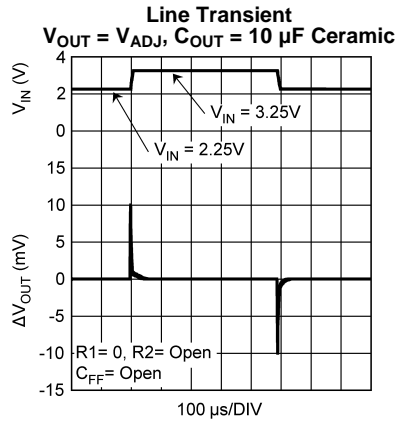

Figure 16.

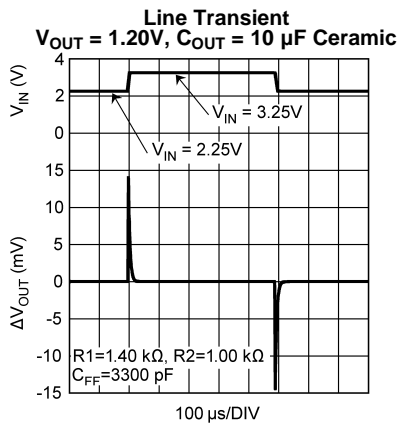

Figure 17.

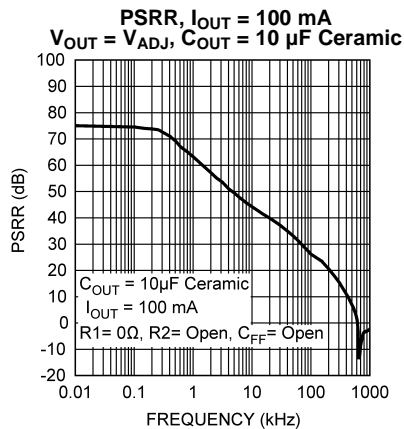

Figure 18.

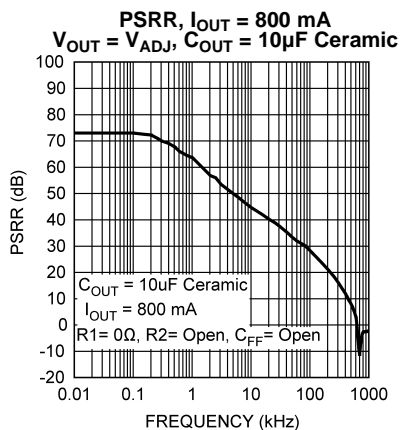

Figure 19.

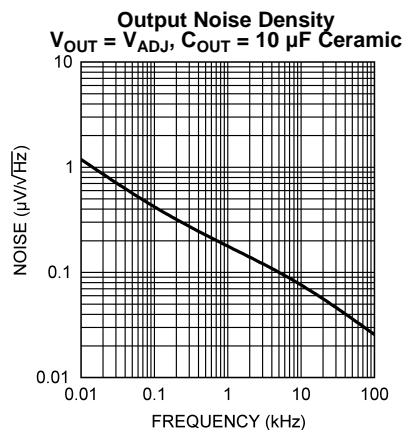
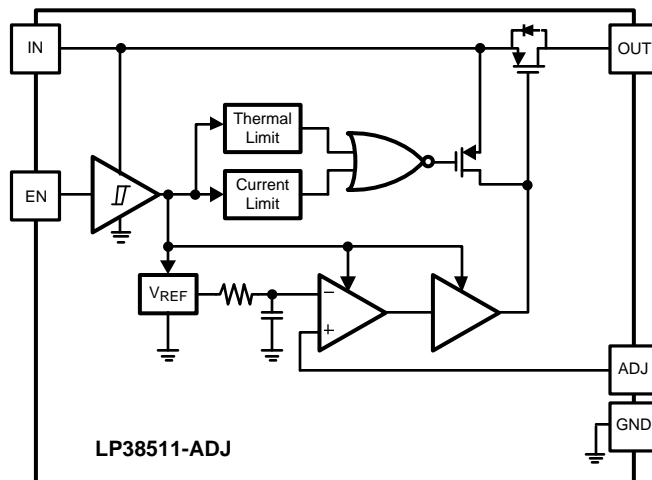

Figure 20.

Block Diagram



APPLICATION INFORMATION

EXTERNAL CAPACITORS

Like any low-dropout regulator, external capacitors are required to assure stability. These capacitors must be correctly selected for proper performance.

Input Capacitor

A ceramic input capacitor of at least 10 μF is required. For general usage across all load currents and operating conditions, a 10 μF ceramic input capacitor will provide satisfactory performance.

Output Capacitor

A ceramic capacitor with a minimum value of 10 μF is required at the output pin for loop stability. It must be located less than 1 cm from the device and connected directly to the output and ground pin using traces which have no other currents flowing through them. As long as the minimum of 10 μF ceramic is met, there is no limitation on any additional capacitance.

X7R and X5R dielectric ceramic capacitors are strongly recommended, as they typically maintain a capacitance range within $\pm 20\%$ of nominal over full operating ratings of temperature and voltage. Of course, they are typically larger and more costly than Z5U/Y5U types for a given voltage and capacitance.

Z5U and Y5V dielectric ceramics are not recommended as the capacitance will drop severely with applied voltage. A typical Z5U or Y5V capacitor can lose 60% of its rated capacitance with half of the rated voltage applied to it. The Z5U and Y5V also exhibit a severe temperature effect, losing more than 50% of nominal capacitance at high and low limits of the temperature range.

REVERSE VOLTAGE

A reverse voltage condition will exist when the voltage at the output pin is higher than the voltage at the input pin. Typically this will happen when V_{IN} is abruptly taken low and C_{OUT} continues to hold a sufficient charge such that the input to output voltage becomes reversed. A less common condition is when an alternate voltage source is connected to the output.

There are two possible paths for current to flow from the output pin back to the input during a reverse voltage condition.

While V_{IN} is high enough to keep the control circuitry alive, and the Enable pin is above the $V_{\text{EN(ON)}}$ threshold, the control circuitry will attempt to regulate the output voltage. Since the input voltage is less than the programmed output voltage, the control circuit will drive the gate of the pass element to the full on condition when the output voltage begins to fall. In this condition, reverse current will flow from the output pin to the input pin, limited only by the $R_{\text{DS(ON)}}$ of the pass element and the output to input voltage differential. Discharging an output capacitor up to 1000 μF in this manner will not damage the device as the current will rapidly decay. However, continuous reverse current should be avoided. When the Enable is low this condition will be prevented.

The internal PFET pass element in the LP38511-ADJ has an inherent parasitic diode. During normal operation, the input voltage is higher than the output voltage and the parasitic diode is reverse biased. However, if the output voltage to input voltage differential is more than 500 mV (typical) the parasitic diode becomes forward biased and current flows from the output pin to the input pin through the diode. The current in the parasitic diode should be limited to less than 1A continuous and 5A peak.

If used in a dual-supply system where the regulator output load is returned to a negative supply, the output pin must be diode clamped to ground. A Schottky diode is recommended for this protective clamp.

SHORT-CIRCUIT PROTECTION

The LP38511-ADJ is short circuit protected, and in the event of a peak over-current condition the short-circuit control loop will rapidly drive the output PMOS pass element off. Once the power pass element shuts down, the control loop will rapidly cycle the output on and off until the average power dissipation causes the thermal shutdown circuit to respond to servo the on/off cycling to a lower frequency. Please refer to the [POWER DISSIPATION/HEAT-SINKING](#) section for power dissipation calculations.

SETTING THE OUTPUT VOLTAGE

The output voltage is set using the external resistive divider R1 and R2. The output voltage is given by the formula:

$$V_{OUT} = V_{ADJ} \times (1 + (R1/R2)) \quad (1)$$

The resistors used for R1 and R2 should be high quality, tight tolerance, and with matching temperature coefficients. It is important to remember that, although the value of V_{ADJ} is specified, the final value of V_{OUT} is not. The use of low quality resistors for R1 and R2 can easily produce a V_{OUT} value that is unacceptable.

It is recommended that the values selected for R1 and R2 are such that the parallel value is less than 1.00 k Ω . This is to reduce the possibility of any internal parasitic capacitances on the ADJ pin from creating an undesirable phase shift that may interfere with device stability.

$$((R1 \times R2) / (R1 + R2)) \leq 1.00 \text{ k}\Omega \quad (2)$$

FEED FORWARD CAPACITOR, C_{FF}

When using a ceramic capacitor for C_{OUT} , the typical ESR value will be too small to provide any meaningful positive phase compensation, F_Z , to offset the internal negative phase shifts in the gain loop.

$$F_Z = 1 / (2 \times \pi \times C_{OUT} \times \text{ESR}) \quad (3)$$

A capacitor placed across the gain resistor R1 will provide additional phase margin to improve load transient response of the device. This capacitor, C_{FF} , in parallel with R1, will form a zero in the loop response given by the formula:

$$F_Z = 1 / (2 \times \pi \times C_{FF} \times R1) \quad (4)$$

For optimum load transient response select C_{FF} so the zero frequency, F_Z , falls between 20 kHz and 40 kHz.

$$C_{FF} = 1 / (2 \times \pi \times R1 \times F_Z) \quad (5)$$

The phase lead provided by C_{FF} diminishes as the DC gain approaches unity, or V_{OUT} approaches V_{ADJ} . This is because C_{FF} also forms a pole with a frequency of:

$$F_P = 1 / (2 \times \pi \times C_{FF} \times (R1 \parallel R2)) \quad (6)$$

It's important to note that at higher output voltages, where R1 is much larger than R2, the pole and zero are far apart in frequency. At lower output voltages the frequency of the pole and the zero mover closer together. The phase lead provided from C_{FF} diminishes quickly as the output voltage is reduced, and has no effect when $V_{OUT} = V_{ADJ}$. For this reason, relying on this compensation technique alone is adequate only for higher output voltages.

Table 1 lists some suggested, best fit, standard $\pm 1\%$ resistor values for R1 and R2, and a standard $\pm 10\%$ capacitor values for C_{FF} , for a range of V_{OUT} values. Other values of R1, R2, and C_{FF} are available that will give similar results.

Table 1.

V_{OUT}	R1	R2	C_{FF}	F_Z
0.80V	1.07 k Ω	1.78 k Ω	4700 pF	31.6 kHz
1.00V	1.00 k Ω	1.00 k Ω	4700 pF	33.8 kHz
1.20V	1.40 k Ω	1.00 k Ω	3300 pF	34.4 kHz
1.50V	2.00 k Ω	1.00 k Ω	2700 pF	29.5 kHz
1.80V	2.94 k Ω	1.13 k Ω	1500 pF	36.1 kHz
2.00V	1.02 k Ω	340 Ω	4700 pF	33.2 kHz
2.50V	1.02 k Ω	255 Ω	4700 pF	33.2 kHz
3.00V	1.00 k Ω	200 Ω	4700 pF	33.8 kHz
3.30V	2.00 k Ω	357 Ω	2700 pF	29.5 kHz

Please refer to Application Note *AN-1378 Method For Calculating Output Voltage Tolerances in Adjustable Regulators* [SNVA112](#) for additional information on how resistor tolerances affect the calculated V_{OUT} value.

ENABLE OPERATION

The Enable ON threshold is typically 1.2V, and the OFF threshold is typically 1.0V. To ensure reliable operation the Enable pin voltage must rise above the maximum $V_{EN(ON)}$ threshold and must fall below the minimum $V_{EN(OFF)}$ threshold. The Enable threshold has typically 200 mV of hysteresis to improve noise immunity.

The Enable pin (EN) has no internal pull-up or pull-down to establish a default condition and, as a result, this pin must be terminated either actively or passively.

If the Enable pin is driven from a single ended device (such as the collector of a discrete transistor) a pull-up resistor to V_{IN} , or a pull-down resistor to ground, will be required for proper operation. A 1 k Ω to 100 k Ω resistor can be used as the pull-up or pull-down resistor to establish default condition for the EN pin. The resistor value selected should be appropriate to swamp out any leakage in the external single ended device, as well as any stray capacitance.

If the Enable pin is driven from a source that actively pulls high and low (such as a CMOS rail to rail comparator output), the pull-up, or pull-down, resistor is not required.

If the application does not require the Enable function, the pin should be connected directly to the adjacent V_{IN} pin.

POWER DISSIPATION/HEAT-SINKING

A heat-sink may be required depending on the maximum power dissipation ($P_{D(MAX)}$), maximum ambient temperature ($T_{A(MAX)}$) of the application, and the thermal resistance (θ_{JA}) of the package. Under all possible conditions, the junction temperature (T_J) must be within the range specified in the [Operating Ratings](#). The total power dissipation of the device is given by:

$$P_D = (V_{IN} - V_{OUT}) \times I_{OUT} + (V_{IN}) \times I_{GND} \quad (7)$$

where I_{GND} is the operating ground current of the device (specified under [Electrical Characteristics](#)).

The maximum allowable junction temperature rise (ΔT_J) depends on the maximum expected ambient temperature ($T_{A(MAX)}$) of the application, and the maximum allowable junction temperature ($T_{J(MAX)}$):

$$\Delta T_J = T_{J(MAX)} - T_{A(MAX)} \quad (8)$$

The maximum allowable value for junction to ambient Thermal Resistance, θ_{JA} , can be calculated using the formula:

$$\theta_{JA} = \Delta T_J / P_{D(MAX)} \quad (9)$$

LP38511-ADJ is available in PFM and SO PowerPad surface mount packages. For a comparison of the PFM package to the standard TO-263 package see Application Note *AN-1797 PFM Package* ([SNVA328](#)). The thermal resistance depends on amount of copper area, or heat sink, and on air flow. See Application Note *AN-1520 A Guide to Board Layout for Best Thermal Resistance for Exposed Packages* ([SNVA183](#)) for guidelines.

Heat-Sinking the PFM Package

The DAP of the PFM package is soldered to the copper plane for heat sinking. The PFM package has a θ_{JA} rating of 67°C/W, and a θ_{JC} rating of 2°C/W. The θ_{JA} rating of 67°C/W includes the device DAP soldered to an area of 0.055 square inches (0.22 in x 0.25 in) of 1 ounce copper on a two sided PCB, with no airflow. See JEDEC standard EIA/JESD51-3 for more information.

[Figure 21](#) shows a curve for the θ_{JA} of PFM package for different thermal via counts under the exposed DAP, using a four layer PCB for heat sinking. The thermal vias connect the copper area directly under the exposed DAP to the first internal copper plane only. See JEDEC standards EIA/JESD51-5 and EIA/JESD51-7 for more information.

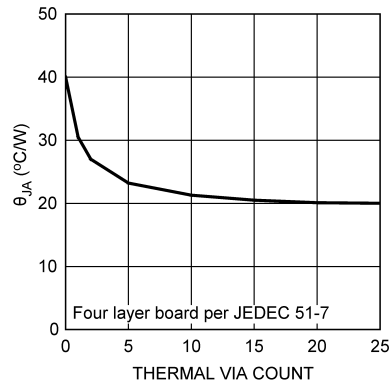

Figure 21. θ_{JA} vs Thermal Via Count for the PFM Package on 4-Layer PCB

Figure 22 shows the thermal performance when the PFM is mounted to a two layer PCB where the copper area is predominately directly under the exposed DAP. As shown in the figure, increasing the copper area beyond 1 square inch produces very little improvement.

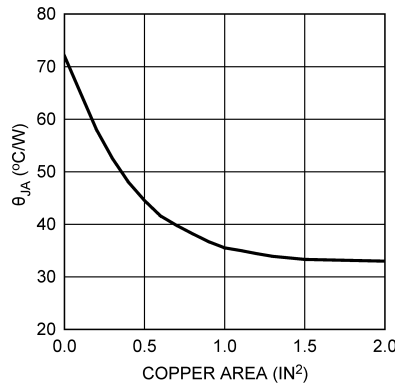

Figure 22. θ_{JA} vs Copper Area for the PFM Package

Heat-Sinking The SO PowerPad Package

The DAP of the SO PowerPad package is soldered to the copper plane for heat sinking. The LP38511MR package has a θ_{JA} rating of 168°C/W, and a θ_{JC} rating of 11°C/W. The θ_{JA} rating of 168°C/W includes the device DAP soldered to an area of 0.008 square inches (0.09 in x 0.09 in) of 1 ounce copper on a two sided PCB, with no airflow. See JEDEC standard EIA/JESD51-3 for more information.

Figure 23 shows a curve for different thermal via counts under the exposed DAP, using a four layer PCB for heat sinking. The thermal vias connect the copper area directly under the exposed DAP to the first internal copper plane only. See JEDEC standards EIA/JESD51-5 and EIA/JESD51-7 for more information.

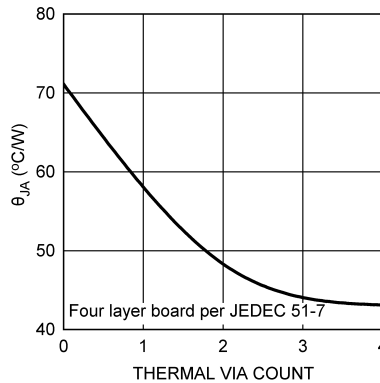

Figure 23. θ_{JA} vs Thermal Via Count for the SO PowerPad Package on 4-Layer PCB

Figure 24 shows thermal performance for a two layer board using thermal vias to a copper area on the bottom of the PCB. The copper area on the top of the PCB, which is soldered to the exposed DAP, is 0.10in x 0.20in, which is approximately the same dimensions as the body of the SO PowerPad package. The copper area on the bottom of the PCB is a square area and is centered directly under the SO PowerPad package.

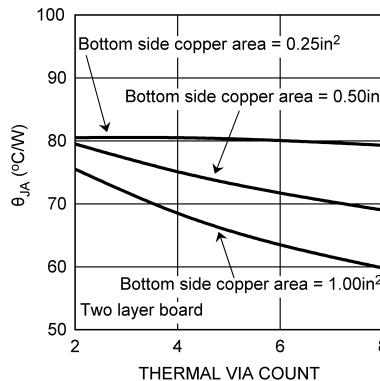

Figure 24. θ_{JA} vs Thermal Via Count for the SO PowerPad Package on 2-Layer PCB with Copper Area on Bottom-Side

Figure 25 shows thermal performance for a two layer board with the DAP soldered to copper area on the of the PCB only. Increasing the copper area soldered to the DAP to 1 square inch of 1 ounce copper, using a dog-bone type layout, will produce a typical θ_{JA} rating of 98°C/W.

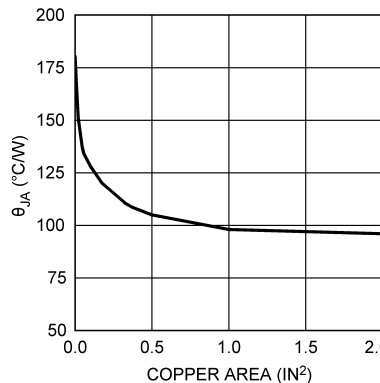

Figure 25. θ_{JA} vs Copper Area for the SO PowerPad Package on 2-Layer PCB with Copper Area on Top-Side

REVISION HISTORY

Changes from Revision C (April 2013) to Revision D	Page
• Changed layout of National Data Sheet to TI format	13

PACKAGING INFORMATION

Orderable Device	Status (1)	Package Type	Package Drawing	Pins	Package Qty	Eco Plan (2)	Lead/Ball Finish (6)	MSL Peak Temp (3)	Op Temp (°C)	Device Marking (4/5)	Samples
LP38511MR-ADJ/NOPB	ACTIVE	SO PowerPAD	DDA	8	95	Green (RoHS & no Sb/Br)	CU SN	Level-3-260C-168 HR	-40 to 125	L38511 -ADJ	Samples
LP38511MRX-ADJ/NOPB	ACTIVE	SO PowerPAD	DDA	8	2500	Green (RoHS & no Sb/Br)	CU SN	Level-3-260C-168 HR	-40 to 125	L38511 -ADJ	Samples
LP38511TJ-ADJ/NOPB	ACTIVE	TO-263	NDQ	5	1000	Green (RoHS & no Sb/Br)	CU SN	Level-1-260C-UNLIM	-40 to 125	LP38511 TJ-ADJ	Samples

(1) The marketing status values are defined as follows:

ACTIVE: Product device recommended for new designs.

LIFEBUY: TI has announced that the device will be discontinued, and a lifetime-buy period is in effect.

NRND: Not recommended for new designs. Device is in production to support existing customers, but TI does not recommend using this part in a new design.

PREVIEW: Device has been announced but is not in production. Samples may or may not be available.

OBsolete: TI has discontinued the production of the device.

(2) Eco Plan - The planned eco-friendly classification: Pb-Free (RoHS), Pb-Free (RoHS Exempt), or Green (RoHS & no Sb/Br) - please check <http://www.ti.com/productcontent> for the latest availability information and additional product content details.

TBD: The Pb-Free/Green conversion plan has not been defined.

Pb-Free (RoHS): TI's terms "Lead-Free" or "Pb-Free" mean semiconductor products that are compatible with the current RoHS requirements for all 6 substances, including the requirement that lead not exceed 0.1% by weight in homogeneous materials. Where designed to be soldered at high temperatures, TI Pb-Free products are suitable for use in specified lead-free processes.

Pb-Free (RoHS Exempt): This component has a RoHS exemption for either 1) lead-based flip-chip solder bumps used between the die and package, or 2) lead-based die adhesive used between the die and leadframe. The component is otherwise considered Pb-Free (RoHS compatible) as defined above.

Green (RoHS & no Sb/Br): TI defines "Green" to mean Pb-Free (RoHS compatible), and free of Bromine (Br) and Antimony (Sb) based flame retardants (Br or Sb do not exceed 0.1% by weight in homogeneous material)

(3) MSL, Peak Temp. - The Moisture Sensitivity Level rating according to the JEDEC industry standard classifications, and peak solder temperature.

(4) There may be additional marking, which relates to the logo, the lot trace code information, or the environmental category on the device.

(5) Multiple Device Markings will be inside parentheses. Only one Device Marking contained in parentheses and separated by a "~" will appear on a device. If a line is indented then it is a continuation of the previous line and the two combined represent the entire Device Marking for that device.

(6) Lead/Ball Finish - Orderable Devices may have multiple material finish options. Finish options are separated by a vertical ruled line. Lead/Ball Finish values may wrap to two lines if the finish value exceeds the maximum column width.

Important Information and Disclaimer: The information provided on this page represents TI's knowledge and belief as of the date that it is provided. TI bases its knowledge and belief on information provided by third parties, and makes no representation or warranty as to the accuracy of such information. Efforts are underway to better integrate information from third parties. TI has taken and

continues to take reasonable steps to provide representative and accurate information but may not have conducted destructive testing or chemical analysis on incoming materials and chemicals. TI and TI suppliers consider certain information to be proprietary, and thus CAS numbers and other limited information may not be available for release.

In no event shall TI's liability arising out of such information exceed the total purchase price of the TI part(s) at issue in this document sold by TI to Customer on an annual basis.

TAPE AND REEL INFORMATION



QUADRANT ASSIGNMENTS FOR PIN 1 ORIENTATION IN TAPE



*All dimensions are nominal

Device	Package Type	Package Drawing	Pins	SPQ	Reel Diameter (mm)	Reel Width W1 (mm)	A0 (mm)	B0 (mm)	K0 (mm)	P1 (mm)	W (mm)	Pin1 Quadrant
LP38511MRX-ADJ/NOPB	SO Power PAD	DDA	8	2500	330.0	12.4	6.5	5.4	2.0	8.0	12.0	Q1
LP38511TJ-ADJ/NOPB	TO-263	NDQ	5	1000	330.0	24.4	10.6	15.4	2.45	12.0	24.0	Q2

TAPE AND REEL BOX DIMENSIONS

*All dimensions are nominal

Device	Package Type	Package Drawing	Pins	SPQ	Length (mm)	Width (mm)	Height (mm)
LP38511MRX-ADJ/NOPB	SO PowerPAD	DDA	8	2500	367.0	367.0	35.0
LP38511TJ-ADJ/NOPB	TO-263	NDQ	5	1000	367.0	367.0	35.0

NDQ0005A

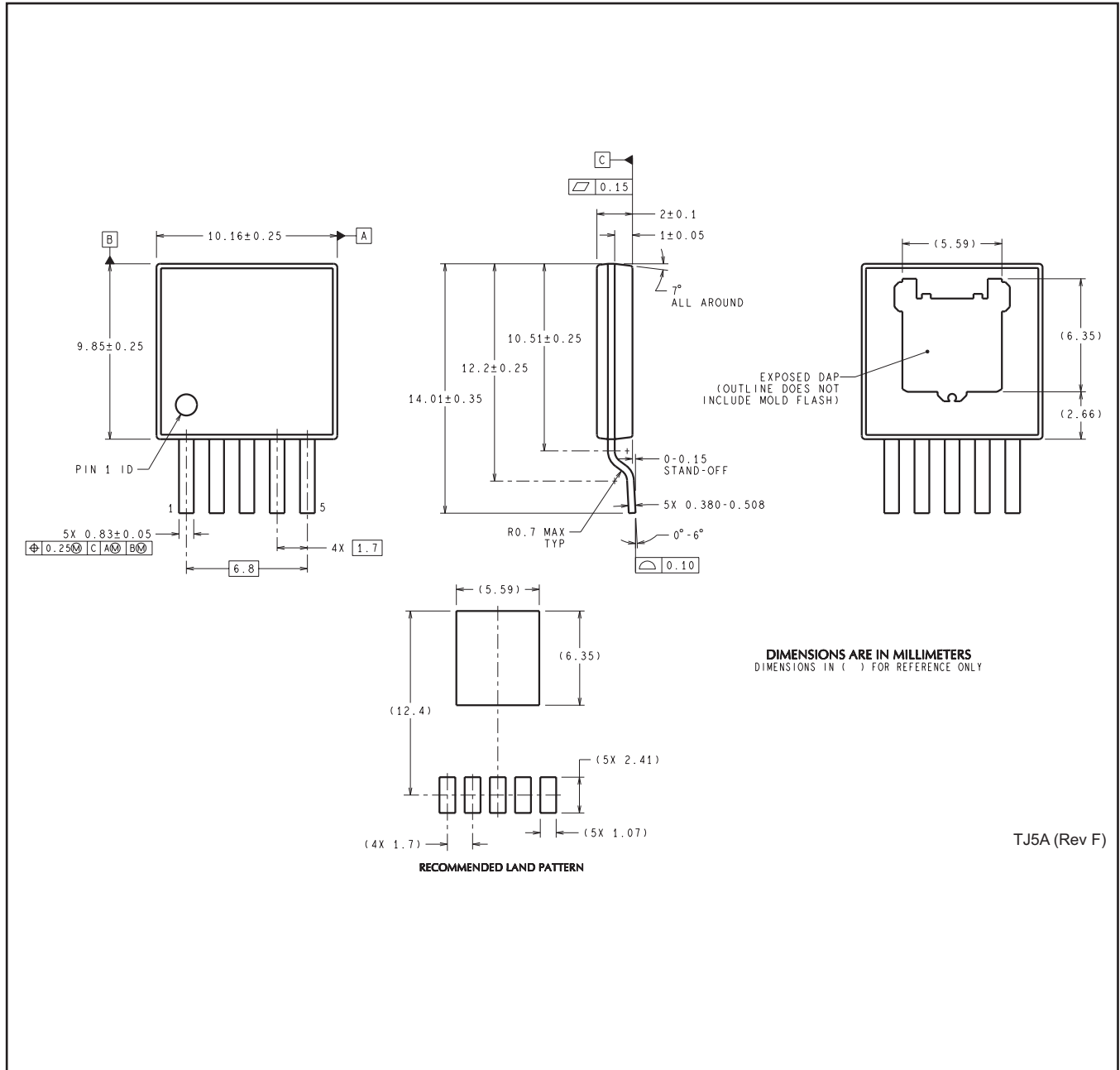

TJ5A (Rev F)

DDA0008A

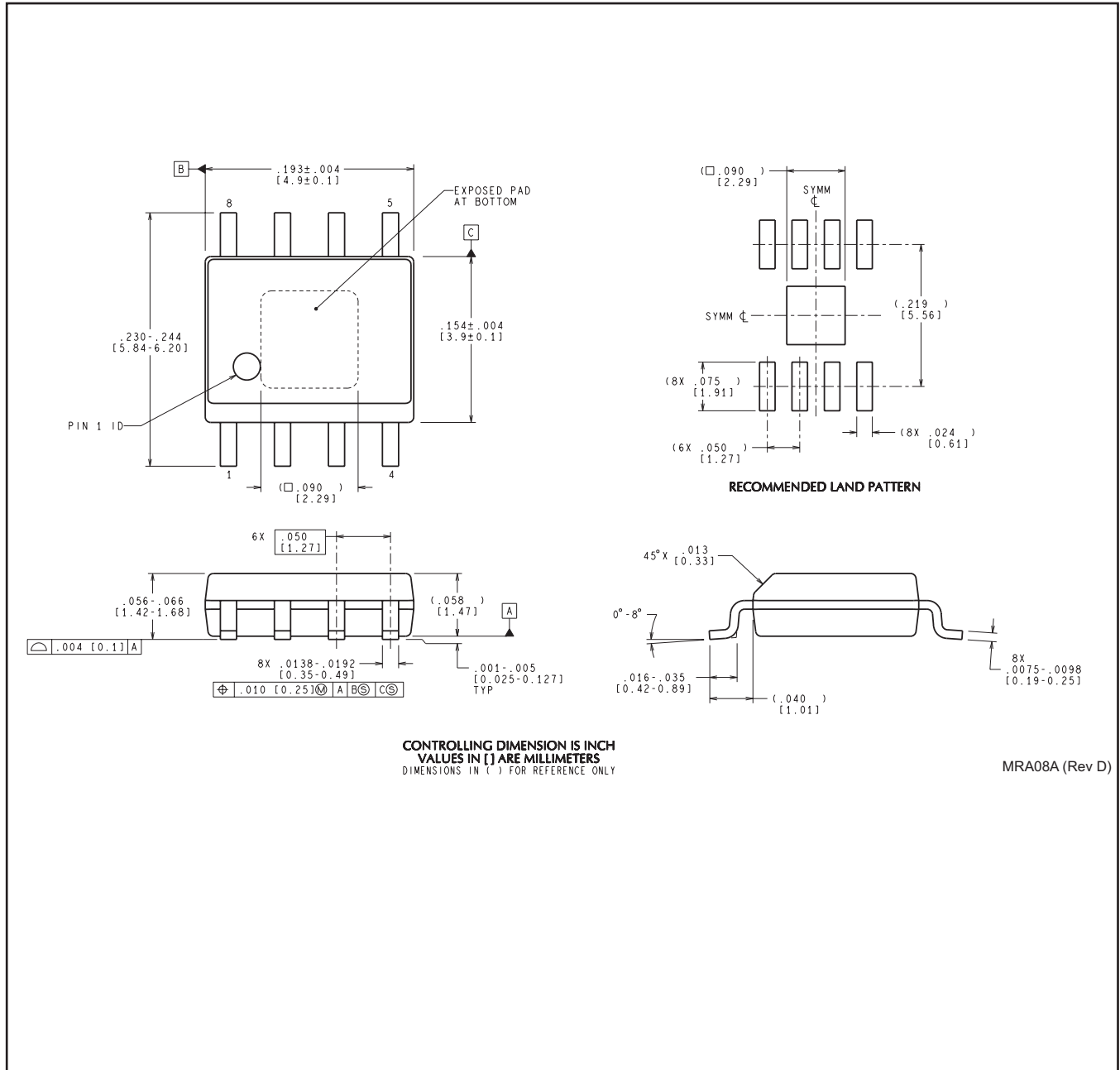

MRA08A (Rev D)

IMPORTANT NOTICE

Texas Instruments Incorporated and its subsidiaries (TI) reserve the right to make corrections, enhancements, improvements and other changes to its semiconductor products and services per JESD46, latest issue, and to discontinue any product or service per JESD48, latest issue. Buyers should obtain the latest relevant information before placing orders and should verify that such information is current and complete. All semiconductor products (also referred to herein as "components") are sold subject to TI's terms and conditions of sale supplied at the time of order acknowledgment.

TI warrants performance of its components to the specifications applicable at the time of sale, in accordance with the warranty in TI's terms and conditions of sale of semiconductor products. Testing and other quality control techniques are used to the extent TI deems necessary to support this warranty. Except where mandated by applicable law, testing of all parameters of each component is not necessarily performed.

TI assumes no liability for applications assistance or the design of Buyers' products. Buyers are responsible for their products and applications using TI components. To minimize the risks associated with Buyers' products and applications, Buyers should provide adequate design and operating safeguards.

TI does not warrant or represent that any license, either express or implied, is granted under any patent right, copyright, mask work right, or other intellectual property right relating to any combination, machine, or process in which TI components or services are used. Information published by TI regarding third-party products or services does not constitute a license to use such products or services or a warranty or endorsement thereof. Use of such information may require a license from a third party under the patents or other intellectual property of the third party, or a license from TI under the patents or other intellectual property of TI.

Reproduction of significant portions of TI information in TI data books or data sheets is permissible only if reproduction is without alteration and is accompanied by all associated warranties, conditions, limitations, and notices. TI is not responsible or liable for such altered documentation. Information of third parties may be subject to additional restrictions.

Resale of TI components or services with statements different from or beyond the parameters stated by TI for that component or service voids all express and any implied warranties for the associated TI component or service and is an unfair and deceptive business practice. TI is not responsible or liable for any such statements.

Buyer acknowledges and agrees that it is solely responsible for compliance with all legal, regulatory and safety-related requirements concerning its products, and any use of TI components in its applications, notwithstanding any applications-related information or support that may be provided by TI. Buyer represents and agrees that it has all the necessary expertise to create and implement safeguards which anticipate dangerous consequences of failures, monitor failures and their consequences, lessen the likelihood of failures that might cause harm and take appropriate remedial actions. Buyer will fully indemnify TI and its representatives against any damages arising out of the use of any TI components in safety-critical applications.

In some cases, TI components may be promoted specifically to facilitate safety-related applications. With such components, TI's goal is to help enable customers to design and create their own end-product solutions that meet applicable functional safety standards and requirements. Nonetheless, such components are subject to these terms.

No TI components are authorized for use in FDA Class III (or similar life-critical medical equipment) unless authorized officers of the parties have executed a special agreement specifically governing such use.

Only those TI components which TI has specifically designated as military grade or "enhanced plastic" are designed and intended for use in military/aerospace applications or environments. Buyer acknowledges and agrees that any military or aerospace use of TI components which have **not** been so designated is solely at the Buyer's risk, and that Buyer is solely responsible for compliance with all legal and regulatory requirements in connection with such use.

TI has specifically designated certain components as meeting ISO/TS16949 requirements, mainly for automotive use. In any case of use of non-designated products, TI will not be responsible for any failure to meet ISO/TS16949.

Products

Audio	www.ti.com/audio
Amplifiers	amplifier.ti.com
Data Converters	dataconverter.ti.com
DLP® Products	www.dlp.com
DSP	dsp.ti.com
Clocks and Timers	www.ti.com/clocks
Interface	interface.ti.com
Logic	logic.ti.com
Power Mgmt	power.ti.com
Microcontrollers	microcontroller.ti.com
RFID	www.ti-rfid.com
OMAP Applications Processors	www.ti.com/omap
Wireless Connectivity	www.ti.com/wirelessconnectivity

Applications

Automotive and Transportation	www.ti.com/automotive
Communications and Telecom	www.ti.com/communications
Computers and Peripherals	www.ti.com/computers
Consumer Electronics	www.ti.com/consumer-apps
Energy and Lighting	www.ti.com/energy
Industrial	www.ti.com/industrial
Medical	www.ti.com/medical
Security	www.ti.com/security
Space, Avionics and Defense	www.ti.com/space-avionics-defense
Video and Imaging	www.ti.com/video

TI E2E Community

e2e.ti.com