

TLE207x, TLE207xA EXCALIBUR LOW-NOISE HIGH-SPEED JFET-INPUT OPERATIONAL AMPLIFIERS

SLOS181C – FEBRUARY 1997 – REVISED DECEMBER 2009

- **Direct Upgrades to TL05x, TL07x, and TL08x BiFET Operational Amplifiers**
- **Greater Than 2× Bandwidth (10 MHz) and 3× Slew Rate (45 V/μs) Than TL07x**
- **Ensured Maximum Noise Floor 17 nV/√Hz**
- **On-Chip Offset Voltage Trimming for Improved DC Performance**
- **Wider Supply Rails Increase Dynamic Signal Range to ±19 V**

description

The TLE207x series of JFET-input operational amplifiers more than double the bandwidth and triple the slew rate of the TL07x and TL08x families of BiFET operational amplifiers. Texas Instruments Excalibur process yields a typical noise floor of 11.6 nV/√Hz, 17-nV/√Hz ensured maximum, offering immediate improvement in noise-sensitive circuits designed using the TL07x. The TLE207x also has wider supply voltage rails, increasing the dynamic signal range for BiFET circuits to ±19 V. On-chip zener trimming of offset voltage yields precision grades for greater accuracy in dc-coupled applications. The TLE207x are pin-compatible with lower performance BiFET operational amplifiers for ease in improving performance in existing designs.

BiFET operational amplifiers offer the inherently higher input impedance of the JFET-input transistors, without sacrificing the output drive associated with bipolar amplifiers. This makes them better suited for interfacing with high-impedance sensors or very low-level ac signals. They also feature inherently better ac response than bipolar or CMOS devices having comparable power consumption.

The TLE207x family of BiFET amplifiers are Texas Instruments highest performance BiFETs, with tighter input offset voltage and ensured maximum noise specifications. Designers requiring less stringent specifications but seeking the improved ac characteristics of the TLE207x should consider the TLE208x operational amplifier family.

Because BiFET operational amplifiers are designed for use with dual power supplies, care must be taken to observe common-mode input voltage limits and output swing when operating from a single supply. DC biasing of the input signal is required and loads should be terminated to a virtual ground node at mid-supply. Texas Instruments TLE2426 integrated virtual ground generator is useful when operating BiFET amplifiers from single supplies.

The TLE207x are fully specified at ±15 V and ±5 V. For operation in low-voltage and/or single-supply systems, Texas Instruments LinCMOS families of operational amplifiers (TLC- and TLV-prefix) are recommended. When moving from BiFET to CMOS amplifiers, particular attention should be paid to slew rate and bandwidth requirements and output loading.



Please be aware that an important notice concerning availability, standard warranty, and use in critical applications of Texas Instruments semiconductor products and disclaimers thereto appears at the end of this data sheet.

PRODUCTION DATA information is current as of publication date. Products conform to specifications per the terms of Texas Instruments standard warranty. Production processing does not necessarily include testing of all parameters.



POST OFFICE BOX 655303 • DALLAS, TEXAS 75265

Copyright © 1997 – 2004, Texas Instruments Incorporated

TLE207x, TLE207xA EXCALIBUR LOW-NOISE HIGH-SPEED JFET-INPUT OPERATIONAL AMPLIFIERS

SLOS181C – FEBRUARY 1997 – REVISED DECEMBER 2009

TLE2071 AVAILABLE OPTIONS

| T _A | V _{IO} max AT 25°C | PACKAGED DEVICES | | | | |
|----------------|--------------------------------|--------------------------|---------------------------|---------------------------|-------------------------|-----------------------------|
| | | SMALL OUTLINE† (D) | CHIP CARRIER (FK) | CERAMIC DIP (JG) | PLASTIC DIP (P) | CERAMIC FLAT PACK (U) |
| 0°C to 70°C | 2 mV 4 mV | TLE2071ACD TLE2071CD | — | — | TLE2071ACP TLE2071CP | — |
| –40°C to 85°C | 2 mV 4 mV | TLE2071AID TLE2071ID | — | — | TLE2071AIP TLE2071IP | — |
| –55°C to 125°C | 2 mV 4 mV | — — | TLE2071AMFK TLE2071MFK | TLE2071AMJG TLE2071MJG | — — | TLE2071AMU TLE2071MU |

† The D packages are available taped and reeled. Add R suffix to device type (e.g., TLE2071ACDR).

TLE2072 AVAILABLE OPTIONS

| T _A | V _{IO} max AT 25°C | PACKAGED DEVICES | | | | |
|----------------|--------------------------------|--------------------------|---------------------------|---------------------------|-------------------------|-----------------------------|
| | | SMALL OUTLINE† (D) | CHIP CARRIER (FK) | CERAMIC DIP (JG) | PLASTIC DIP (P) | CERAMIC FLAT PACK (U) |
| 0°C to 70°C | 3.5 mV 6 mV | TLE2072ACD TLE2072CD | — | — | TLE2072ACP TLE2072CP | — |
| –40°C to 85°C | 3.5 mV 6 mV | TLE2072AID TLE2072ID | — | — | TLE2072AIP TLE2072IP | — |
| –55°C to 125°C | 3.5 mV 6 mV | — | TLE2072AMFK TLE2072MFK | TLE2072AMJG TLE2072MJG | — | TLE2072AMU TLE2072MU |

† The D packages are available taped and reeled. Add R suffix to device type (e.g., TLE2072ACDR).

TLE2074 AVAILABLE OPTIONS

| T _A | V _{IO} max AT 25°C | PACKAGED DEVICES | | | | |
|----------------|--------------------------------|---------------------------|---------------------------|-------------------------|-------------------------|-----------------------------|
| | | SMALL OUTLINE† (DW) | CHIP CARRIER (FK) | CERAMIC DIP (J) | PLASTIC DIP (N) | CERAMIC FLAT PACK (W) |
| 0°C to 70°C | 3 mV 5 mV | TLE2074ACDW TLE2074CDW | — | — | TLE2074ACN TLE2074CN | — |
| –40°C to 85°C | 3 mV 5 mV | TLE2074AIDW TLE2074IDW | — | — | TLE2074AIN TLE2074IN | — |
| –55°C to 125°C | 3 mV 5 mV | — | TLE2074AMFK TLE2074MFK | TLE2074AMJ TLE2074MJ | — | TLE2074AMW TLE2074MW |

† The DW packages are available taped and reeled. Add R suffix to device type (e.g., TLE2074ACDWR).

symbol

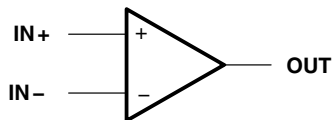

TLE207x, TLE207xA EXCALIBUR LOW-NOISE HIGH-SPEED JFET-INPUT OPERATIONAL AMPLIFIERS

SLOS181C – FEBRUARY 1997 – REVISED DECEMBER 2009

**TLE2071 AND TLE2071A
D, JG, OR P PACKAGE
(TOP VIEW)**

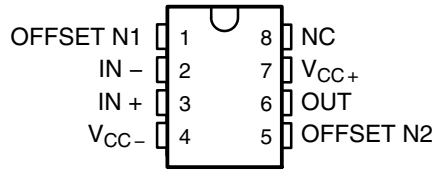

**TLE2072 AND TLE2072A
D, JG, OR P PACKAGE
(TOP VIEW)**

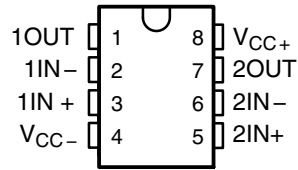

**TLE2074 AND TLE2074A
J, N, OR W PACKAGE
(TOP VIEW)**

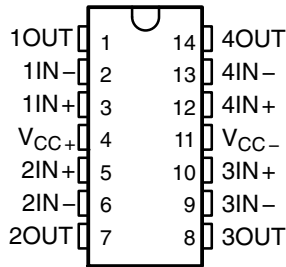

**TLE2074 AND TLE2074A
DW PACKAGE
(TOP VIEW)**

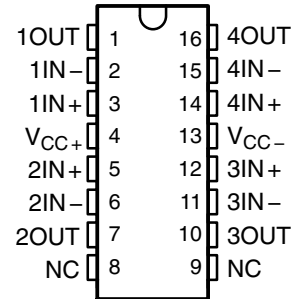

**TLE2071M AND TLE2071AM
FK PACKAGE
(TOP VIEW)**

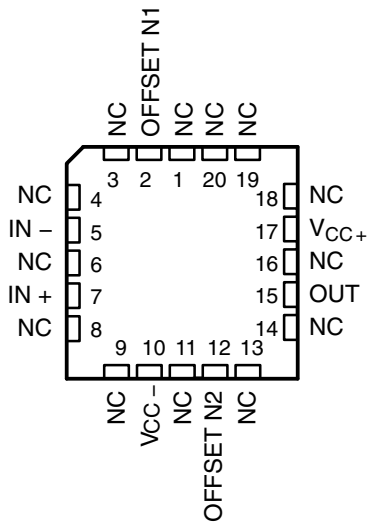

**TLE2072M AND TLE2072AM
FK PACKAGE
(TOP VIEW)**

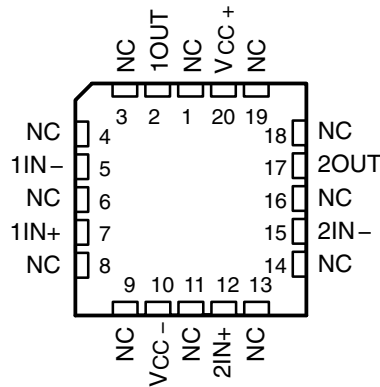

**TLE2074M AND TLE2074AM
FK PACKAGE
(TOP VIEW)**

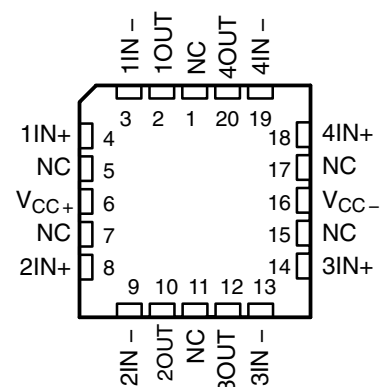

**TLE2071 AND TLE2071A
U PACKAGE
(TOP VIEW)**

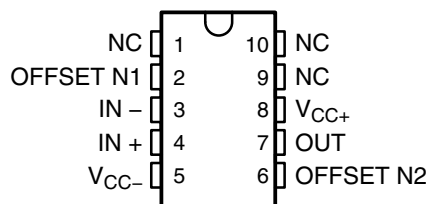

**TLE2072 AND TLE2072A
U PACKAGE
(TOP VIEW)**

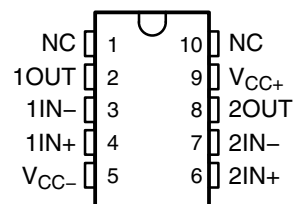

NC – No internal connection

TLE207X, TLE207XA
EXCALIBUR LOW-NOISE HIGH-SPEED
JFET-INPUT OPERATIONAL AMPLIFIERS
SLOS181C - FEBRUARY 1997 - REVISED DECEMBER 2009

equivalent schematic

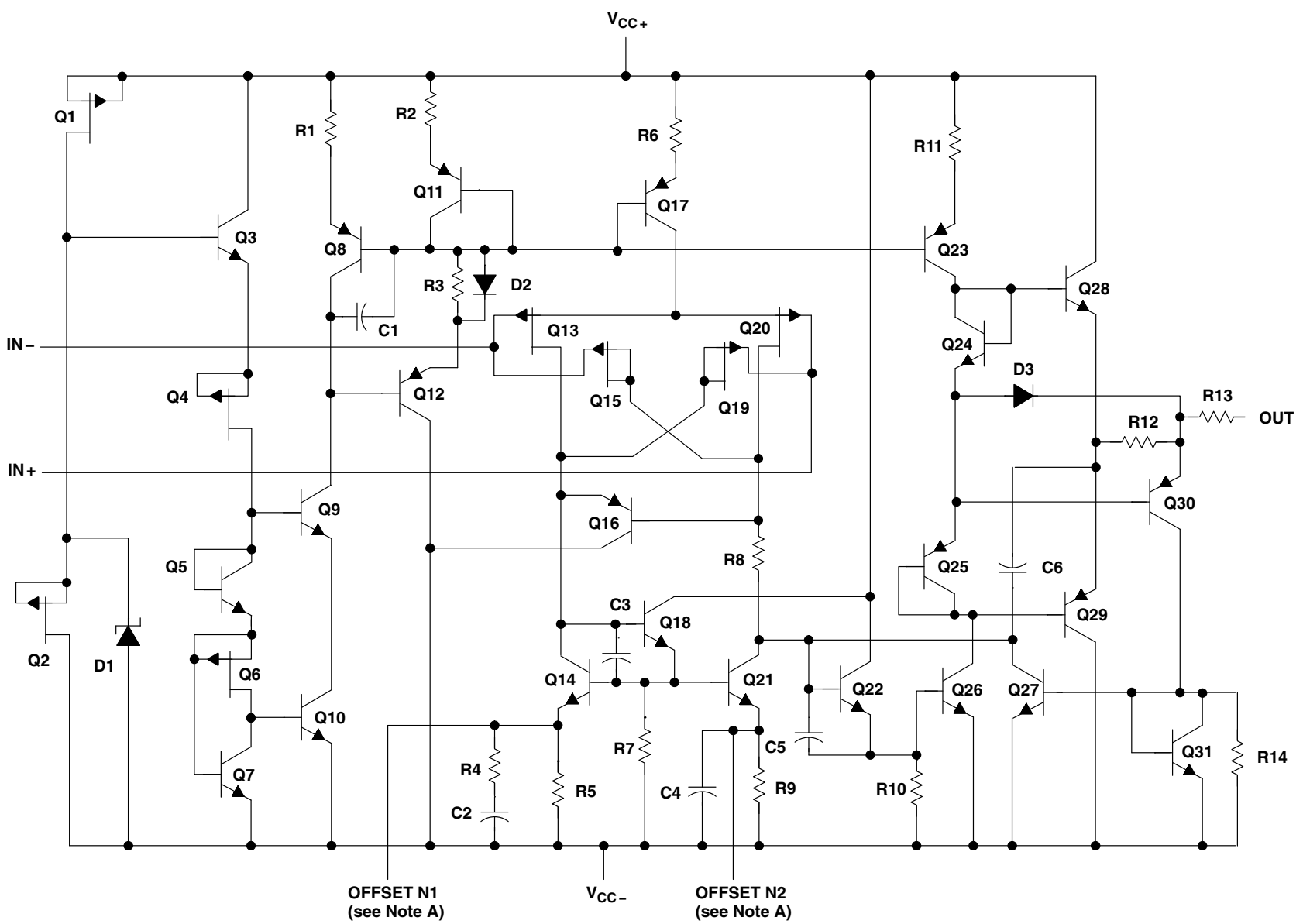

NOTES: A. OFFSET N1 AND OFFSET N2 are only available on the TLE2071x devices.

equivalent schematic (continued)

| ACTUAL DEVICE COMPONENT COUNT | | | |
|-------------------------------|---------|---------|---------|
| COMPONENT | TLE2071 | TLE2072 | TLE2074 |
| Transistors | 33 | 57 | 114 |
| Resistors | 25 | 37 | 74 |
| Diodes | 8 | 5 | 10 |
| Capacitors | 6 | 11 | 22 |

TLE207x, TLE207xA

EXCALIBUR LOW-NOISE HIGH-SPEED

JFET-INPUT OPERATIONAL AMPLIFIERS

SLOS181C – FEBRUARY 1997 – REVISED DECEMBER 2009

absolute maximum ratings over operating free-air temperature range (unless otherwise noted)[†]

| | |
|--------------------------------------------------------------------------------------|------------------------|
| Supply voltage, V_{CC+} (see Note 1) | 19 V |
| Supply voltage, V_{CC-} (see Note 1) | -19 V |
| Differential input voltage range, V_{ID} (see Note 2) | V_{CC+} to V_{CC-} |
| Input voltage range, V_I (any input) | V_{CC+} to V_{CC-} |
| Input current, I_I (each input) | ± 1 mA |
| Output current, I_O (each output) | ± 80 mA |
| Total current into V_{CC+} | 160 mA |
| Total current out of V_{CC-} | 160 mA |
| Duration of short-circuit current at (or below) 25°C (see Note 3) | unlimited |
| Package thermal impedance, θ_{JA} (see Notes 4 and 5): | |
| D package | 97.1°C/W |
| DW package | 57.3°C/W |
| N package | 79.7°C/W |
| P package | 84.6°C/W |
| Package thermal impedance, θ_{JC} (see Notes 4 and 5): | |
| FK package | 5.6°C/W |
| J package | 15.1°C/W |
| JG package | 14.5°C/W |
| U package | 14.7°C/W |
| W package | 10°C/W |
| Operating free-air temperature range, T_A : C suffix | 0°C to 70°C |
| I suffix | -40°C to 85°C |
| M suffix | -55°C to 125°C |
| Storage temperature range | -65°C to 150°C |
| Case temperature for 60 seconds: FK package | 260°C |
| Lead temperature 1,6 mm (1/16 inch) from case for 10 seconds: DW or N package | 260°C |
| Lead temperature 1,6 mm (1/16 inch) from case for 60 seconds: J, JG, U, or W package | 300°C |

[†] Stresses beyond those listed under “absolute maximum ratings” may cause permanent damage to the device. These are stress ratings only, and functional operation of the device at these or any other conditions beyond those indicated under “recommended operating conditions” is not implied. Exposure to absolute-maximum-rated conditions for extended periods may affect device reliability.

- NOTES:
- All voltage values, except differential voltages, are with respect to the midpoint between V_{CC+} and V_{CC-} .
 - Differential voltages are at the noninverting input with respect to the inverting input.
 - The output may be shorted to either supply. Temperatures and/or supply voltages must be limited to ensure that the maximum dissipation rate is not exceeded.
 - Maximum power dissipation is a function of $T_J(\text{max})$, θ_{JA} , and T_A . The maximum allowable power dissipation at any allowable ambient temperature is $P_D = (T_J(\text{max}) - T_A)/\theta_{JA}$. Operating at the absolute maximum T_J of 150°C can affect reliability.
 - The package thermal impedance is calculated in accordance with JEDEC 51-7 (plastic) or MIL-STD-883 Method 1012 (ceramic).

recommended operating conditions

| | | C SUFFIX | | I SUFFIX | | M SUFFIX | | UNIT |
|---------------------------------------|------------------------|------------|----------|------------|----------|------------|----------|------|
| | | MIN | MAX | MIN | MAX | MIN | MAX | |
| Supply voltage, $V_{CC\pm}$ | | ± 2.25 | ± 19 | ± 2.25 | ± 19 | ± 2.25 | ± 19 | V |
| Common-mode input voltage, V_{IC} | $V_{CC\pm} = \pm 5$ V | -0.9 | 5 | -0.8 | 5 | -0.8 | 5 | V |
| | $V_{CC\pm} = \pm 15$ V | -10.9 | 15 | -10.8 | 15 | -10.8 | 15 | |
| Operating free-air temperature, T_A | | 0 | 70 | -40 | 85 | -55 | 125 | °C |



TLE207x, TLE207xA
EXCALIBUR LOW-NOISE HIGH-SPEED
JFET-INPUT OPERATIONAL AMPLIFIERS

SLOS181C – FEBRUARY 1997 – REVISED DECEMBER 2009

TLE2071C electrical characteristics at specified free-air temperature, $V_{CC\pm} = \pm 5\text{ V}$ (unless otherwise noted)

| PARAMETER | TEST CONDITIONS | T_A^\dagger | TLE2071C | | | TLE2071AC | | | UNIT | |
|---------------------------------------------------------------------------------|-----------------------------------------------------------------------------------------|----------------------------|------------|-----------|-----|-----------|-----------|------------------------------|----------|----|
| | | | MIN | TYP | MAX | MIN | TYP | MAX | | |
| V_{IO} Input offset voltage | $V_{IC} = 0,$ $R_S = 50\ \Omega$ | $V_O = 0,$ 25°C | 0.34 | 4 | | 0.3 | 2 | mV | | |
| | | Full range | | | 6 | | 4 | | | |
| α_{VIO} Temperature coefficient of input offset voltage | | Full range | 3.2 | 29 | | 3.2 | 29 | $\mu\text{V}/^\circ\text{C}$ | | |
| I_{IO} Input offset current | $V_{IC} = 0,$ $V_O = 0,$ See Figure 4 | 25°C | 5 | 100 | | 5 | 100 | pA | | |
| | | Full range | | | 1.4 | | 1.4 | nA | | |
| I_{IB} Input bias current | | 25°C | 15 | 175 | | 15 | 175 | pA | | |
| | | Full range | | | 5 | | 5 | nA | | |
| V_{ICR} Common-mode input voltage range | $R_S = 50\ \Omega$ | 25°C | 5 to -1 | 5 to -1.9 | | 5 to -1 | 5 to -1.9 | V | | |
| | | Full range | 5 to -0.9 | | | 5 to -0.9 | | | | |
| V_{OM+} Maximum positive peak output voltage swing | $I_O = -200\ \mu\text{A}$ | 25°C | 3.8 | 4.1 | | 3.8 | 4.1 | V | | |
| | | Full range | 3.7 | | | 3.7 | | | | |
| | $I_O = -2\ \text{mA}$ | 25°C | 3.5 | 3.9 | | 3.5 | 3.9 | | | |
| | | Full range | 3.4 | | | 3.4 | | | | |
| | $I_O = -20\ \text{mA}$ | 25°C | 1.5 | 2.3 | | 1.5 | 2.3 | | | |
| | | Full range | 1.5 | | | 1.5 | | | | |
| V_{OM-} Maximum negative peak output voltage swing | $I_O = 200\ \mu\text{A}$ | 25°C | -3.5 | -4.2 | | -3.5 | -4.2 | V | | |
| | | Full range | -3.4 | | | -3.4 | | | | |
| | $I_O = 2\ \text{mA}$ | 25°C | -3.7 | -4.1 | | -3.7 | -4.1 | | | |
| | | Full range | -3.6 | | | -3.6 | | | | |
| | $I_O = 20\ \text{mA}$ | 25°C | -1.5 | -2.4 | | -1.5 | -2.4 | | | |
| | | Full range | -1.5 | | | -1.5 | | | | |
| A_{VD} Large-signal differential voltage amplification | $V_O = \pm 2.3\ \text{V}$ | $R_L = 600\ \Omega$ | 25°C | 80 | 91 | | 80 | 91 | dB | |
| | | | Full range | 79 | | | 79 | | | |
| | | $R_L = 2\ \text{k}\Omega$ | 25°C | 90 | 100 | | 90 | 100 | | |
| | | | Full range | 89 | | | 89 | | | |
| | | $R_L = 10\ \text{k}\Omega$ | 25°C | 95 | 106 | | 95 | 106 | | |
| | | | Full range | 94 | | | 94 | | | |
| r_i Input resistance | $V_{IC} = 0$ | 25°C | 10^{12} | | | 10^{12} | | | Ω | |
| c_i Input capacitance | $V_{IC} = 0,$ See Figure 5 | Common mode | 25°C | 11 | | | 11 | | | pF |
| | | Differential | 25°C | 2.5 | | | 2.5 | | | |
| z_o Open-loop output impedance | $f = 1\ \text{MHz}$ | 25°C | 80 | | | 80 | | | Ω | |
| CMRR Common-mode rejection ratio | $V_{IC} = V_{ICRmin},$ $V_O = 0,$ $R_S = 50\ \Omega$ | 25°C | 70 | 89 | | 70 | 89 | dB | | |
| | | Full range | 68 | | | 68 | | | | |
| k_{SVR} Supply-voltage rejection ratio ($\Delta V_{CC\pm} / \Delta V_{IO}$) | $V_{CC\pm} = \pm 5\ \text{V to } \pm 15\ \text{V},$ $V_O = 0,$ $R_S = 50\ \Omega$ | 25°C | 82 | 99 | | 82 | 99 | dB | | |
| | | Full range | 80 | | | 80 | | | | |

† Full range is 0°C to 70°C.



TLE207x, TLE207xA
EXCALIBUR LOW-NOISE HIGH-SPEED
JFET-INPUT OPERATIONAL AMPLIFIERS

SLOS181C – FEBRUARY 1997 – REVISED DECEMBER 2009

TLE2071C electrical characteristics at specified free-air temperature, $V_{CC\pm} = \pm 5\text{ V}$ (unless otherwise noted) (continued)

| PARAMETER | TEST CONDITIONS | T_A^\dagger | TLE2071C | | | TLE2071AC | | | UNIT |
|---------------------------------------|---------------------|------------------------|----------|-----|-----|-----------|-----|-----|------|
| | | | MIN | TYP | MAX | MIN | TYP | MAX | |
| I_{CC} Supply current | $V_O = 0$, No load | 25°C | 1.35 | 1.6 | 2.2 | 1.35 | 1.6 | 2.2 | mA |
| | | Full range | | | | 2.2 | | | |
| I_{OS} Short-circuit output current | $V_O = 0$ | $V_{ID} = 1\text{ V}$ | -35 | | | -35 | | | mA |
| | | $V_{ID} = -1\text{ V}$ | 45 | | | 45 | | | |

† Full range is 0°C to 70°C.

TLE2071C operating characteristics at specified free-air temperature, $V_{CC\pm} = \pm 5\text{ V}$

| PARAMETER | TEST CONDITIONS | T_A^\dagger | TLE2071C | | | TLE2071AC | | | UNIT | |
|---------------------------------------------------------|------------------------------------------------------------------------------------------------------------------------|---------------------------------------------|----------|--------|-----|-----------|--------|------------------------|------------------------|-----|
| | | | MIN | TYP | MAX | MIN | TYP | MAX | | |
| SR+ Positive slew rate | $V_{O(PP)} = \pm 2.3\text{ V}$, $A_{VD} = -1$, $R_L = 2\text{ k}\Omega$, $C_L = 100\text{ pF}$, See Figure 1 | 25°C | 35 | | | 35 | | | V/ μ s | |
| | | Full range | 23 | | | 23 | | | | |
| SR- Negative slew rate | | 25°C | 38 | | | 38 | | | V/ μ s | |
| | | Full range | 23 | | | 23 | | | | |
| t_s Settling time | $A_{VD} = -1$, 2-V step, $R_L = 1\text{ k}\Omega$, $C_L = 100\text{ pF}$ | To 10 mV | 0.25 | | | 0.25 | | | μ s | |
| | | To 1 mV | 0.4 | | | 0.4 | | | | |
| V_n Equivalent input noise voltage | $R_S = 20\ \Omega$, See Figure 3 | f = 10 Hz | 48 | 85 | | 48 | 85 | nV/ $\sqrt{\text{Hz}}$ | | |
| | | f = 10 kHz | 12 | 17 | | 12 | 17 | | | |
| $V_{N(PP)}$ Peak-to-peak equivalent input noise voltage | | f = 10 Hz to 10 kHz | 6 | | | 6 | | | μ V | |
| | | f = 0.1 Hz to 10 Hz | 0.6 | | | 0.6 | | | | |
| I_n Equivalent input noise current | $V_{IC} = 0$, f = 10 kHz | 25°C | 2.8 | | | 2.8 | | | fA/ $\sqrt{\text{Hz}}$ | |
| THD + N Total harmonic distortion plus noise | $V_{O(PP)} = 5\text{ V}$, f = 1 kHz, $R_S = 25\ \Omega$ | $A_{VD} = 10$, $R_L = 2\text{ k}\Omega$ | 25°C | 0.013% | | | 0.013% | | | |
| B_1 Unity-gain bandwidth | $V_I = 10\text{ mV}$, $C_L = 25\text{ pF}$ | $R_L = 2\text{ k}\Omega$, See Figure 2 | 25°C | 9.4 | | | 9.4 | | | MHz |
| B_{OM} Maximum output-swing bandwidth | $V_{O(PP)} = 4\text{ V}$, $R_L = 2\text{ k}\Omega$ | $A_{VD} = -1$, $C_L = 25\text{ pF}$ | 25°C | 2.8 | | | 2.8 | | | MHz |
| ϕ_m Phase margin at unity gain | $V_I = 10\text{ mV}$, $C_L = 25\text{ pF}$ | $R_L = 2\text{ k}\Omega$, See Figure 2 | 25°C | 56° | | | 56° | | | |

† Full range is 0°C to 70°C.



TLE207x, TLE207xA
EXCALIBUR LOW-NOISE HIGH-SPEED
JFET-INPUT OPERATIONAL AMPLIFIERS

SLOS181C – FEBRUARY 1997 – REVISED DECEMBER 2009

TLE2071C electrical characteristics at specified free-air temperature, $V_{CC\pm} = \pm 15$ V (unless otherwise noted)

| PARAMETER | TEST CONDITIONS | T_A † | TLE2071C | | | TLE2071AC | | | UNIT | |
|-------------------------------------------------------------------------------|-------------------------------------------------------------------------|-----------------------|-------------|-------------|-----|-------------|-------------|------------------|----------|----|
| | | | MIN | TYP | MAX | MIN | TYP | MAX | | |
| V_{IO} Input offset voltage | $V_{IC} = 0,$ $R_S = 50 \Omega$ $V_O = 0,$ | 25°C | 0.49 | 4 | | 0.47 | 2 | mV | | |
| | | Full range | | | 6 | | 4 | | | |
| α_{VIO} Temperature coefficient of input offset voltage | | Full range | 3.2 | 29 | | 3.2 | 29 | $\mu V/^\circ C$ | | |
| I_{IO} Input offset current | $V_{IC} = 0,$ $V_O = 0,$ See Figure 4 | 25°C | 6 | 100 | | 6 | 100 | pA | | |
| | | Full range | | 1.4 | | | 1.4 | nA | | |
| I_{IB} Input bias current | | 25°C | 20 | 175 | | 20 | 175 | pA | | |
| | | Full range | | 5 | | | 5 | nA | | |
| V_{ICR} Common-mode input voltage range | $R_S = 50 \Omega$ | 25°C | 15 to -11 | 15 to -11.9 | | 15 to -11 | 15 to -11.9 | V | | |
| | | Full range | 15 to -10.9 | | | 15 to -10.9 | | | | |
| V_{OM+} Maximum positive peak output voltage swing | $I_O = -200 \mu A$ | 25°C | 13.8 | 14.1 | | 13.8 | 14.1 | V | | |
| | | Full range | 13.7 | | | 13.7 | | | | |
| | $I_O = -2$ mA | 25°C | 13.5 | 13.9 | | 13.5 | 13.9 | | | |
| | | Full range | 13.4 | | | 13.4 | | | | |
| | $I_O = -20$ mA | 25°C | 11.5 | 12.3 | | 11.5 | 12.3 | | | |
| | | Full range | 11.5 | | | 11.5 | | | | |
| V_{OM-} Maximum negative peak output voltage swing | $I_O = 200 \mu A$ | 25°C | -13.8 | -14.2 | | -13.8 | -14.2 | V | | |
| | | Full range | -13.7 | | | -13.7 | | | | |
| | $I_O = 2$ mA | 25°C | -13.5 | -14 | | -13.5 | -14 | | | |
| | | Full range | -13.4 | | | -13.4 | | | | |
| | $I_O = 20$ mA | 25°C | -11.5 | -12.4 | | -11.5 | -12.4 | | | |
| | | Full range | -11.5 | | | -11.5 | | | | |
| A_{VD} Large-signal differential voltage amplification | $V_O = \pm 10$ V | $R_L = 600 \Omega$ | 25°C | 80 | 96 | | 80 | 96 | dB | |
| | | | Full range | 79 | | | 79 | | | |
| | | $R_L = 2$ k Ω | 25°C | 90 | 109 | | 90 | 109 | | |
| | | | Full range | 89 | | | 89 | | | |
| | | $R_L = 10$ k Ω | 25°C | 95 | 118 | | 95 | 118 | | |
| | | | Full range | 94 | | | 94 | | | |
| r_i Input resistance | $V_{IC} = 0$ | 25°C | 10^{12} | | | 10^{12} | | | Ω | |
| c_i Input capacitance | $V_{IC} = 0,$ See Figure 5 | Common mode | 25°C | 7.5 | | | 7.5 | | | pF |
| | | Differential | 25°C | 2.5 | | | 2.5 | | | |
| z_o Open-loop output impedance | $f = 1$ MHz | 25°C | 80 | | | 80 | | | Ω | |
| CMRR Common-mode rejection ratio | $V_{IC} = V_{ICRmin},$ $V_O = 0,$ $R_S = 50 \Omega$ | 25°C | 80 | 98 | | 80 | 98 | dB | | |
| | | Full range | 79 | | | 79 | | | | |
| k_{SVR} Supply-voltage rejection ratio ($\Delta V_{CC\pm}/\Delta V_{IO}$) | $V_{CC\pm} = \pm 5$ V to ± 15 V, $V_O = 0,$ $R_S = 50 \Omega$ | 25°C | 82 | 99 | | 82 | 99 | dB | | |
| | | Full range | 80 | | | 81 | | | | |

† Full range is 0°C to 70°C.



TLE207x, TLE207xA EXCALIBUR LOW-NOISE HIGH-SPEED JFET-INPUT OPERATIONAL AMPLIFIERS

SLOS181C – FEBRUARY 1997 – REVISED DECEMBER 2009

TLE2071C electrical characteristics at specified free-air temperature, $V_{CC\pm} = \pm 15$ V (unless otherwise noted) (continued)

| PARAMETER | TEST CONDITIONS | T_A † | TLE2071C | | | TLE2071AC | | | UNIT |
|---------------------------------------|---------------------|-----------------|----------|-----|-----|-----------|-----|-----|------|
| | | | MIN | TYP | MAX | MIN | TYP | MAX | |
| I_{CC} Supply current | $V_O = 0$, No load | 25°C | 1.35 | 1.7 | 2.2 | 1.35 | 1.7 | 2.2 | mA |
| | | Full range | 2.2 | | | 2.2 | | | |
| I_{OS} Short-circuit output current | $V_O = 0$ | $V_{ID} = 1$ V | -30 | -45 | | -30 | -45 | | mA |
| | | $V_{ID} = -1$ V | 30 | 48 | | 30 | 48 | | |

† Full range is 0°C to 70°C.

TLE2071C operating characteristics at specified free-air temperature, $V_{CC\pm} = \pm 15$ V

| PARAMETER | TEST CONDITIONS | T_A † | TLE2071C | | | TLE2071AC | | | UNIT |
|---------------------------------------------------------|-------------------------------------------------------------------------------------------------|---------------------|----------|-----|-----|-----------|-----|-----|-----------------|
| | | | MIN | TYP | MAX | MIN | TYP | MAX | |
| SR+ Positive slew rate | $V_{O(PP)} = 10$ V, $A_{VD} = -1$, $R_L = 2$ k Ω , See Figure 1 | 25°C | 30 | 40 | | 30 | 40 | | V/ μ s |
| | | Full range | 27 | | | 27 | | | |
| SR- Negative slew rate | | 25°C | 30 | 45 | | 30 | 45 | | V/ μ s |
| | | Full range | 27 | | | 27 | | | |
| t_s Settling time | $A_{VD} = -1$, 10-V step, $R_L = 1$ k Ω , $C_L = 100$ pF | To 10 mV | 0.4 | | | 0.4 | | | μ s |
| | | To 1 mV | 1.5 | | | 1.5 | | | |
| V_n Equivalent input noise voltage | $R_S = 20$ Ω , See Figure 3 | f = 10 Hz | 48 | 85 | | 48 | 85 | | nV/ \sqrt{Hz} |
| | | f = 10 kHz | 12 | 17 | | 12 | 17 | | |
| $V_{N(PP)}$ Peak-to-peak equivalent input noise voltage | $R_S = 20$ Ω , See Figure 3 | f = 10 Hz to 10 kHz | 6 | | | 6 | | | μ V |
| | | f = 0.1 Hz to 10 Hz | 0.6 | | | 0.6 | | | |
| I_n Equivalent input noise current | $V_{IC} = 0$, f = 10 kHz | 25°C | 2.8 | | | 2.8 | | | fA/ \sqrt{Hz} |
| THD + N Total harmonic distortion plus noise | $V_{O(PP)} = 20$ V, $A_{VD} = 10$, f = 1 kHz, $R_L = 2$ k Ω , $R_S = 25$ Ω | 25°C | 0.008% | | | 0.008% | | | |
| B_1 Unity-gain bandwidth | $V_I = 10$ mV, $R_L = 2$ k Ω , $C_L = 25$ pF, See Figure 2 | 25°C | 8 | 10 | | 8 | 10 | | MHz |
| B_{OM} Maximum output-swing bandwidth | $V_{O(PP)} = 20$ V, $A_{VD} = -1$, $R_L = 2$ k Ω , $C_L = 25$ pF | 25°C | 478 | 637 | | 478 | 637 | | kHz |
| ϕ_m Phase margin at unity gain | $V_I = 10$ mV, $R_L = 2$ k Ω , $C_L = 25$ pF, See Figure 2 | 25°C | 57° | | | 57° | | | |

† Full range is 0°C to 70°C.



TLE207x, TLE207xA
EXCALIBUR LOW-NOISE HIGH-SPEED
JFET-INPUT OPERATIONAL AMPLIFIERS

SLOS181C – FEBRUARY 1997 – REVISED DECEMBER 2009

TLE2071I electrical characteristics at specified free-air temperature, $V_{CC\pm} = \pm 5\text{ V}$ (unless otherwise noted)

| PARAMETER | TEST CONDITIONS | T_A † | TLE2071I | | | TLE2071AI | | | UNIT | |
|-------------------------------------------------------------------------------|------------------------------------------------------------------------------------------|----------------------------|------------|-----------|-----|-----------|-----------|------------------------------|----------|----|
| | | | MIN | TYP | MAX | MIN | TYP | MAX | | |
| V_{IO} Input offset voltage | $V_{IC} = 0,$ $R_S = 50\ \Omega,$ $V_O = 0,$ | 25°C | 0.34 | 4 | | 0.3 | 2 | mV | | |
| | | Full range | | | 7.6 | | 5.6 | | | |
| α_{VIO} Temperature coefficient of input offset voltage | | Full range | 3.2 | 29 | | 3.2 | 29 | $\mu\text{V}/^\circ\text{C}$ | | |
| I_{IO} Input offset current | $V_{IC} = 0,$ $V_O = 0,$ See Figure 4 | 25°C | 5 | 100 | | 5 | 100 | pA | | |
| | | Full range | | 5 | | | 5 | nA | | |
| I_{IB} Input bias current | | 25°C | 15 | 175 | | 15 | 175 | pA | | |
| | | Full range | | 10 | | | 10 | nA | | |
| V_{ICR} Common-mode input voltage range | $R_S = 50\ \Omega$ | 25°C | 5 to -1 | 5 to -1.9 | | 5 to -1 | 5 to -1.9 | V | | |
| | | Full range | 5 to -0.8 | | | 5 to -0.8 | | | | |
| V_{OM+} Maximum positive peak output voltage swing | $I_O = -200\ \mu\text{A}$ | 25°C | 3.8 | 4.1 | | 3.8 | 4.1 | V | | |
| | | Full range | 3.7 | | | 3.7 | | | | |
| | $I_O = -2\ \text{mA}$ | 25°C | 3.5 | 3.9 | | 3.5 | 3.9 | | | |
| | | Full range | 3.4 | | | 3.4 | | | | |
| | $I_O = -20\ \text{mA}$ | 25°C | 1.5 | 2.3 | | 1.5 | 2.3 | | | |
| | | Full range | 1.5 | | | 1.5 | | | | |
| V_{OM-} Maximum negative peak output voltage swing | $I_O = 200\ \mu\text{A}$ | 25°C | -3.8 | -4.2 | | -3.8 | -4.2 | V | | |
| | | Full range | -3.7 | | | -3.7 | | | | |
| | $I_O = 2\ \text{mA}$ | 25°C | -3.5 | -4.1 | | -3.5 | -4.1 | | | |
| | | Full range | -3.4 | | | -3.4 | | | | |
| | $I_O = 20\ \text{mA}$ | 25°C | -1.5 | -2.4 | | -1.5 | -2.4 | | | |
| | | Full range | -1.5 | | | -1.5 | | | | |
| A_{VD} Large-signal differential voltage amplification | $V_O = \pm 2.3\ \text{V}$ | $R_L = 600\ \Omega$ | 25°C | 80 | 91 | | 80 | 91 | dB | |
| | | | Full range | 79 | | | 79 | | | |
| | | $R_L = 2\ \text{k}\Omega$ | 25°C | 90 | 100 | | 90 | 100 | | |
| | | | Full range | 89 | | | 89 | | | |
| | | $R_L = 10\ \text{k}\Omega$ | 25°C | 95 | 106 | | 95 | 106 | | |
| | | | Full range | 94 | | | 94 | | | |
| r_i Input resistance | $V_{IC} = 0$ | 25°C | 10^{12} | | | 10^{12} | | | Ω | |
| c_i Input capacitance | $V_{IC} = 0,$ See Figure 5 | Common mode | 25°C | 11 | | | 11 | | | pF |
| | | Differential | 25°C | 2.5 | | | 2.5 | | | |
| z_o Open-loop output impedance | $f = 1\ \text{MHz}$ | 25°C | 80 | | | 80 | | | Ω | |
| CMRR Common-mode rejection ratio | $V_{IC} = V_{ICRmin},$ $V_O = 0,$ $R_S = 50\ \Omega$ | 25°C | 70 | 89 | | 70 | 89 | dB | | |
| | | Full range | 68 | | | 68 | | | | |
| k_{SVR} Supply-voltage rejection ratio ($\Delta V_{CC\pm}/\Delta V_{IO}$) | $V_{CC\pm} = \pm 5\ \text{V}$ to $\pm 15\ \text{V},$ $V_O = 0,$ $R_S = 50\ \Omega$ | 25°C | 82 | 99 | | 82 | 99 | dB | | |
| | | Full range | 80 | | | 80 | | | | |

† Full range is -40°C to 85°C .



TLE207x, TLE207xA EXCALIBUR LOW-NOISE HIGH-SPEED JFET-INPUT OPERATIONAL AMPLIFIERS

SLOS181C – FEBRUARY 1997 – REVISED DECEMBER 2009

TLE2071I electrical characteristics at specified free-air temperature, $V_{CC\pm} = \pm 5\text{ V}$ (unless otherwise noted) (continued)

| PARAMETER | TEST CONDITIONS | T_A^\dagger | TLE2071I | | | TLE2071AI | | | UNIT |
|---------------------------------------|---------------------|------------------------|----------|-----|-----|-----------|-----|-----|------|
| | | | MIN | TYP | MAX | MIN | TYP | MAX | |
| I_{CC} Supply current | $V_O = 0$, No load | 25°C | 1.35 | 1.6 | 2.2 | 1.35 | 1.6 | 2.2 | mA |
| | | Full range | 2.2 | | | 2.2 | | | |
| I_{OS} Short-circuit output current | $V_O = 0$ | $V_{ID} = 1\text{ V}$ | -35 | | | -35 | | | mA |
| | | $V_{ID} = -1\text{ V}$ | 45 | | | 45 | | | |

† Full range is -40°C to 85°C .

TLE2071I operating characteristics at specified free-air temperature, $V_{CC\pm} = \pm 5\text{ V}$

| PARAMETER | TEST CONDITIONS | T_A^\dagger | TLE2071I | | | TLE2071AI | | | UNIT |
|---------------------------------------------------------|------------------------------------------------------------------------------------------------------------------------|---------------------|----------|-----|-----|-----------|-----|------------------------|------------------------|
| | | | MIN | TYP | MAX | MIN | TYP | MAX | |
| SR+ Positive slew rate | $V_{O(PP)} = \pm 2.3\text{ V}$, $A_{VD} = -1$, $R_L = 2\text{ k}\Omega$, $C_L = 100\text{ pF}$, See Figure 1 | 25°C | 35 | | | 35 | | | V/ μs |
| | | Full range | 22 | | | 22 | | | |
| SR- Negative slew rate | | 25°C | 38 | | | 38 | | | V/ μs |
| | | Full range | 22 | | | 22 | | | |
| t_s Settling time | $A_{VD} = -1$, 2-V step, $R_L = 1\text{ k}\Omega$, $C_L = 100\text{ pF}$ | To 10 mV | 0.25 | | | 0.25 | | | μs |
| | | To 1 mV | 0.4 | | | 0.4 | | | |
| V_n Equivalent input noise voltage | $R_S = 20\ \Omega$, See Figure 3 | f = 10 Hz | 48 | 85 | | 48 | 85 | nV/ $\sqrt{\text{Hz}}$ | |
| | | f = 10 kHz | 12 | 17 | | 12 | 17 | | |
| $V_{N(PP)}$ Peak-to-peak equivalent input noise voltage | | f = 10 Hz to 10 kHz | 6 | | | 6 | | | μV |
| | | f = 0.1 Hz to 10 Hz | 0.6 | | | 0.6 | | | |
| I_n Equivalent input noise current | $V_{IC} = 0$, f = 10 kHz | 25°C | 2.8 | | | 2.8 | | | fA/ $\sqrt{\text{Hz}}$ |
| THD + N Total harmonic distortion plus noise | $V_{O(PP)} = 5\text{ V}$, $A_{VD} = 10$, f = 1 kHz, $R_L = 2\text{ k}\Omega$, $R_S = 25\ \Omega$ | 25°C | 0.013% | | | 0.013% | | | |
| B_1 Unity-gain bandwidth | $V_I = 10\text{ mV}$, $R_L = 2\text{ k}\Omega$, $C_L = 25\text{ pF}$, See Figure 2 | 25°C | 9.4 | | | 9.4 | | | MHz |
| B_{OM} Maximum output-swing bandwidth | $V_{O(PP)} = 4\text{ V}$, $A_{VD} = -1$, $R_L = 2\text{ k}\Omega$, $C_L = 25\text{ pF}$ | 25°C | 2.8 | | | 2.8 | | | MHz |
| ϕ_m Phase margin at unity gain | $V_I = 10\text{ mV}$, $R_L = 2\text{ k}\Omega$, $C_L = 25\text{ pF}$, See Figure 2 | 25°C | 56° | | | 56° | | | |

† Full range is -40°C to 85°C .



TLE207x, TLE207xA
EXCALIBUR LOW-NOISE HIGH-SPEED
JFET-INPUT OPERATIONAL AMPLIFIERS

SLOS181C – FEBRUARY 1997 – REVISED DECEMBER 2009

TLE20711 electrical characteristics at specified free-air temperature, $V_{CC\pm} = \pm 15$ V (unless otherwise noted)

| PARAMETER | TEST CONDITIONS | T_A † | TLE20711 | | | TLE2071AI | | | UNIT | |
|-------------------------------------------------------------------------------|----------------------------------------------------------------------------------------|----------------------------|-------------|-------------|-----|-------------|-------------|------------------------------|----------|----|
| | | | MIN | TYP | MAX | MIN | TYP | MAX | | |
| V_{IO} Input offset voltage | $V_{IC} = 0,$ $R_S = 50 \Omega,$ $V_O = 0,$ | 25°C | 0.49 | 4 | | 0.47 | 2 | mV | | |
| | | Full range | | | 7.6 | | 5.6 | | | |
| α_{VIO} Temperature coefficient of input offset voltage | | Full range | 3.2 | 29 | | 3.2 | 29 | $\mu\text{V}/^\circ\text{C}$ | | |
| I_{IO} Input offset current | $V_{IC} = 0,$ $V_O = 0,$ See Figure 4 | 25°C | 6 | 100 | | 6 | 100 | pA | | |
| | | Full range | | 5 | | | 5 | nA | | |
| I_{IB} Input bias current | | 25°C | 20 | 175 | | 20 | 175 | pA | | |
| | | Full range | | 10 | | | 10 | nA | | |
| V_{ICR} Common-mode input voltage range | $R_S = 50 \Omega$ | 25°C | 15 to -11 | 15 to -11.9 | | 15 to -11 | 15 to -11.9 | V | | |
| | | Full range | 15 to -10.8 | | | 15 to -10.8 | | | | |
| V_{OM+} Maximum positive peak output voltage swing | $I_O = -200 \mu\text{A}$ | 25°C | 13.8 | 14.1 | | 13.8 | 14.1 | V | | |
| | | Full range | 13.7 | | | 13.7 | | | | |
| | $I_O = -2 \text{ mA}$ | 25°C | 13.5 | 13.9 | | 13.5 | 13.9 | | | |
| | | Full range | 13.4 | | | 13.4 | | | | |
| | $I_O = -20 \text{ mA}$ | 25°C | 11.5 | 12.3 | | 11.5 | 12.3 | | | |
| | | Full range | 11.5 | | | 11.5 | | | | |
| V_{OM-} Maximum negative peak output voltage swing | $I_O = 200 \mu\text{A}$ | 25°C | -13.8 | -14.2 | | -13.8 | -14.2 | V | | |
| | | Full range | -13.7 | | | -13.7 | | | | |
| | $I_O = 2 \text{ mA}$ | 25°C | -13.5 | -14 | | -13.5 | -14 | | | |
| | | Full range | -13.4 | | | -13.4 | | | | |
| | $I_O = 20 \text{ mA}$ | 25°C | -11.5 | -12.4 | | -11.5 | -12.4 | | | |
| | | Full range | -11.5 | | | -11.5 | | | | |
| A_{VD} Large-signal differential voltage amplification | $V_O = \pm 10 \text{ V}$ | $R_L = 600 \Omega$ | 25°C | 80 | 96 | | 80 | 96 | dB | |
| | | | Full range | 79 | | | 79 | | | |
| | | $R_L = 2 \text{ k}\Omega$ | 25°C | 90 | 109 | | 90 | 109 | | |
| | | | Full range | 89 | | | 89 | | | |
| | | $R_L = 10 \text{ k}\Omega$ | 25°C | 95 | 118 | | 95 | 118 | | |
| | | | Full range | 94 | | | 94 | | | |
| r_i Input resistance | $V_{IC} = 0$ | 25°C | 10^{12} | | | 10^{12} | | | Ω | |
| c_i Input capacitance | $V_{IC} = 0,$ See Figure 5 | Common mode | 25°C | 7.5 | | | 7.5 | | | pF |
| | | Differential | 25°C | 2.5 | | | 2.5 | | | |
| z_o Open-loop output impedance | $f = 1 \text{ MHz}$ | 25°C | 80 | | | 80 | | | Ω | |
| CMRR Common-mode rejection ratio | $V_{IC} = V_{ICRmin},$ $V_O = 0,$ $R_S = 50 \Omega$ | 25°C | 80 | 98 | | 80 | 98 | dB | | |
| | | Full range | 79 | | | 79 | | | | |
| k_{SVR} Supply-voltage rejection ratio ($\Delta V_{CC\pm}/\Delta V_{IO}$) | $V_{CC\pm} = \pm 5 \text{ V to } \pm 15 \text{ V},$ $V_O = 0,$ $R_S = 50 \Omega$ | 25°C | 82 | 99 | | 82 | 99 | dB | | |
| | | Full range | 80 | | | 80 | | | | |

† Full range is -40°C to 85°C .



TLE207x, TLE207xA EXCALIBUR LOW-NOISE HIGH-SPEED JFET-INPUT OPERATIONAL AMPLIFIERS

SLOS181C – FEBRUARY 1997 – REVISED DECEMBER 2009

TLE2071I electrical characteristics at specified free-air temperature, $V_{CC\pm} = \pm 15$ V (unless otherwise noted) (continued)

| PARAMETER | TEST CONDITIONS | T_A^\dagger | TLE2071I | | | TLE2071AI | | | UNIT |
|---------------------------------------|---------------------|-----------------|----------|-----|-----|-----------|-----|-----|------|
| | | | MIN | TYP | MAX | MIN | TYP | MAX | |
| I_{CC} Supply current | $V_O = 0$, No load | 25°C | 1.35 | 1.7 | 2.2 | 1.35 | 1.7 | 2.2 | mA |
| | | Full range | 2.2 | | | 2.2 | | | |
| I_{OS} Short-circuit output current | $V_O = 0$ | $V_{ID} = 1$ V | -30 | -45 | | -30 | -45 | | mA |
| | | $V_{ID} = -1$ V | 30 | 48 | | 30 | 48 | | |

† Full range is -40°C to 85°C .

TLE2071I operating characteristics at specified free-air temperature, $V_{CC\pm} = \pm 15$ V

| PARAMETER | TEST CONDITIONS | T_A^\dagger | TLE2071I | | | TLE2071AI | | | UNIT | |
|---------------------------------------------------------|---------------------------------------------------------------------------------------------------------|-------------------------------------------|----------|--------|-----|-----------|--------|-----|------------------------|--|
| | | | MIN | TYP | MAX | MIN | TYP | MAX | | |
| SR+ Positive slew rate | $V_{O(PP)} = \pm 10$ V, $A_{VD} = -1$, $C_L = 100$ pF, $R_L = 2$ k Ω , See Figure 1 | 25°C | 30 | 40 | | 30 | 40 | | V/ μ s | |
| | | Full range | 24 | | | 24 | | | | |
| SR- Negative slew rate | | 25°C | 30 | 45 | | 30 | 45 | | V/ μ s | |
| | | Full range | 24 | | | 24 | | | | |
| t_s Settling time | $A_{VD} = -1$, 10-V step, $R_L = 1$ k Ω , $C_L = 100$ pF | To 10 mV | 0.4 | | | 0.4 | | | μ s | |
| | | To 1 mV | 1.5 | | | 1.5 | | | | |
| V_n Equivalent input noise voltage | $R_S = 20$ Ω , See Figure 3 | f = 10 Hz | 48 | 85 | | 48 | 85 | | nV/ $\sqrt{\text{Hz}}$ | |
| | | f = 10 kHz | 12 | 17 | | 12 | 17 | | | |
| $V_{N(PP)}$ Peak-to-peak equivalent input noise voltage | | f = 10 Hz to 10 kHz | 6 | | | 6 | | | μ V | |
| | | f = 0.1 Hz to 10 Hz | 0.6 | | | 0.6 | | | | |
| I_n Equivalent input noise current | $V_{IC} = 0$, f = 10 kHz | 25°C | 2.8 | | | 2.8 | | | fA/ $\sqrt{\text{Hz}}$ | |
| THD + N Total harmonic distortion plus noise | $V_{O(PP)} = 20$ V, f = 1 kHz, $R_S = 25$ Ω | $A_{VD} = 10$, $R_L = 2$ k Ω , | 25°C | 0.008% | | | 0.008% | | | |
| B_1 Unity-gain bandwidth | $V_I = 10$ mV, $C_L = 25$ pF, | $R_L = 2$ k Ω , See Figure 2 | 25°C | 8 | 10 | | 8 | 10 | MHz | |
| B_{OM} Maximum output-swing bandwidth | $V_{O(PP)} = 20$ V, $R_L = 2$ k Ω , | $A_{VD} = -1$, $C_L = 25$ pF | 25°C | 478 | 637 | | 478 | 637 | kHz | |
| ϕ_m Phase margin at unity gain | $V_I = 10$ mV, $C_L = 25$ pF, | $R_L = 2$ k Ω , See Figure 2 | 25°C | 57° | | | 57° | | | |

† Full range is -40°C to 85°C .



TLE207x, TLE207xA
EXCALIBUR LOW-NOISE HIGH-SPEED
JFET-INPUT OPERATIONAL AMPLIFIERS

SLOS181C – FEBRUARY 1997 – REVISED DECEMBER 2009

TLE2071M electrical characteristics at specified free-air temperature, $V_{CC\pm} = \pm 5\text{ V}$ (unless otherwise noted)

| PARAMETER | TEST CONDITIONS | T_A^\dagger | TLE2071M | | | TLE2071AM | | | UNIT | |
|---------------------------------------------------------------------------------|------------------------------------------------------------------------------------------|----------------------------|------------|-----------------|-----|-----------|-----------------|------------------------------|----------|----|
| | | | MIN | TYP | MAX | MIN | TYP | MAX | | |
| V_{IO} Input offset voltage | $V_{IC} = 0,$ $R_S = 50\ \Omega,$ $V_O = 0,$ | 25°C | 0.34 | 4 | | 0.3 | 2 | mV | | |
| | | Full range | | | 9.2 | | 7.2 | | | |
| α_{VIO} Temperature coefficient of input offset voltage | | Full range | 3.2 | 29 [‡] | | 3.2 | 29 [‡] | $\mu\text{V}/^\circ\text{C}$ | | |
| I_{IO} Input offset current | $V_{IC} = 0,$ $V_O = 0,$ See Figure 4 | 25°C | 5 | 100 | | 5 | 100 | pA | | |
| | | Full range | | | 20 | | 20 | nA | | |
| I_{IB} Input bias current | | 25°C | 15 | 175 | | 15 | 175 | pA | | |
| | | Full range | | | 60 | | 60 | nA | | |
| V_{ICR} Common-mode input voltage range | $R_S = 50\ \Omega$ | 25°C | 5 to -1 | 5 to -1.9 | | 5 to -1 | 5 to -1.9 | V | | |
| | | Full range | 5 to -0.8 | | | 5 to -0.8 | | | | |
| V_{OM+} Maximum positive peak output voltage swing | $I_O = -200\ \mu\text{A}$ | 25°C | 3.8 | 4.1 | | 3.8 | 4.1 | V | | |
| | | Full range | 3.6 | | | 3.6 | | | | |
| | $I_O = -2\ \text{mA}$ | 25°C | 3.5 | 3.9 | | 3.5 | 3.9 | | | |
| | | Full range | 3.3 | | | 3.3 | | | | |
| | $I_O = -20\ \text{mA}$ | 25°C | 1.5 | 2.3 | | 1.5 | 2.3 | | | |
| | | Full range | 1.4 | | | 1.4 | | | | |
| V_{OM-} Maximum negative peak output voltage swing | $I_O = 200\ \mu\text{A}$ | 25°C | -3.8 | -4.2 | | -3.8 | -4.2 | V | | |
| | | Full range | -3.6 | | | -3.6 | | | | |
| | $I_O = 2\ \text{mA}$ | 25°C | -3.5 | -4.1 | | -3.5 | -4.1 | | | |
| | | Full range | -3.3 | | | -3.3 | | | | |
| | $I_O = 20\ \text{mA}$ | 25°C | -1.5 | -2.4 | | -1.5 | -2.4 | | | |
| | | Full range | -1.4 | | | -1.4 | | | | |
| A_{VD} Large-signal differential voltage amplification | $V_O = \pm 2.3\ \text{V}$ | $R_L = 600\ \Omega$ | 25°C | 80 | 91 | | 80 | 91 | dB | |
| | | | Full range | 78 | | | 78 | | | |
| | | $R_L = 2\ \text{k}\Omega$ | 25°C | 90 | 100 | | 90 | 100 | | |
| | | | Full range | 88 | | | 88 | | | |
| | | $R_L = 10\ \text{k}\Omega$ | 25°C | 95 | 106 | | 95 | 106 | | |
| | | | Full range | 93 | | | 93 | | | |
| r_i Input resistance | $V_{IC} = 0$ | 25°C | 10^{12} | | | 10^{12} | | | Ω | |
| c_i Input capacitance | $V_{IC} = 0,$ See Figure 5 | Common mode | 25°C | 11 | | | 11 | | | pF |
| | | Differential | 25°C | 2.5 | | | 2.5 | | | |
| z_o Open-loop output impedance | $f = 1\ \text{MHz}$ | 25°C | 80 | | | 80 | | | Ω | |
| CMRR Common-mode rejection ratio | $V_{IC} = V_{ICRmin},$ $V_O = 0,$ $R_S = 50\ \Omega$ | 25°C | 70 | 89 | | 70 | 89 | dB | | |
| | | Full range | 68 | | | 68 | | | | |
| k_{SVR} Supply-voltage rejection ratio ($\Delta V_{CC\pm} / \Delta V_{IO}$) | $V_{CC\pm} = \pm 5\ \text{V}$ to $\pm 15\ \text{V},$ $V_O = 0,$ $R_S = 50\ \Omega$ | 25°C | 82 | 99 | | 82 | 99 | dB | | |
| | | Full range | 80 | | | 80 | | | | |

[†] Full range is -55°C to 125°C .

[‡] *On products compliant to MIL-PRF-38535, Class B, this parameter is not production tested.



TLE207x, TLE207xA
EXCALIBUR LOW-NOISE HIGH-SPEED
JFET-INPUT OPERATIONAL AMPLIFIERS

SLOS181C – FEBRUARY 1997 – REVISED DECEMBER 2009

TLE2071M electrical characteristics at specified free-air temperature, $V_{CC\pm} = \pm 5\text{ V}$ (unless otherwise noted)

| PARAMETER | TEST CONDITIONS | T_A † | TLE2071M | | | TLE2071AM | | | UNIT |
|---------------------------------------|---------------------|------------------------|----------|-----|-----|-----------|-----|-----|------|
| | | | MIN | TYP | MAX | MIN | TYP | MAX | |
| I_{CC} Supply current | $V_O = 0$, No load | 25°C | 1.35 | 1.6 | 2.2 | 1.35 | 1.6 | 2.2 | mA |
| | | Full range | 2.2 | | | 2.2 | | | |
| I_{OS} Short-circuit output current | $V_O = 0$ | $V_{ID} = 1\text{ V}$ | -35 | | | -35 | | | mA |
| | | $V_{ID} = -1\text{ V}$ | 45 | | | 45 | | | |

† Full range is -55°C to 125°C .

TLE2071M operating characteristics at specified free-air temperature, $V_{CC\pm} = \pm 5\text{ V}$

| PARAMETER | TEST CONDITIONS | T_A † | TLE2071M | | | TLE2071AM | | | UNIT | |
|---------------------------------------------------------|------------------------------------------------------------------------------------------------------------------------------|----------------------------------------------------------------|-------------------------------------------------------|--------|-----|-----------|--------|------------------------|------------------|------------------------|
| | | | MIN | TYP | MAX | MIN | TYP | MAX | | |
| SR+ Positive slew rate | $V_{O(PP)} = \pm 2.3\text{ V}$, $A_{VD} = -1$, $C_L = 100\text{ pF}$, $R_L = 2\text{ k}\Omega$, See Figure 1 | 25°C | 35 | | | 35 | | | V/ μs | |
| | | Full range | 20‡ | | | 20‡ | | | | |
| SR- Negative slew rate | | 25°C | 38 | | | 38 | | | V/ μs | |
| | | Full range | 20‡ | | | 20‡ | | | | |
| t_s Settling time | $A_{VD} = -1$, 2-V step, $R_L = 1\text{ k}\Omega$, $C_L = 100\text{ pF}$ | To 10 mV | 0.25 | | | 0.25 | | | μs | |
| | | To 1 mV | 0.4 | | | 0.4 | | | | |
| V_n Equivalent input noise voltage | $R_S = 20\ \Omega$, See Figure 3 | f = 10 Hz | 48 | 85‡ | | 48 | 85‡ | nV/ $\sqrt{\text{Hz}}$ | | |
| | | f = 10 kHz | 12 | 17‡ | | 12 | 17‡ | | | |
| $V_{N(PP)}$ Peak-to-peak equivalent input noise voltage | | f = 10 Hz to 10 kHz | 6 | | | 6 | | | μV | |
| | | f = 0.1 Hz to 10 Hz | 0.6 | | | 0.6 | | | | |
| I_n Equivalent input noise current | | $V_{IC} = 0$, f = 10 kHz | 25°C | 2.8 | | | 2.8 | | | fA/ $\sqrt{\text{Hz}}$ |
| THD + N Total harmonic distortion plus noise | | $V_{O(PP)} = 5\text{ V}$, f = 1 kHz, $R_S = 25\ \Omega$ | $A_{VD} = 10$, $R_L = 2\text{ k}\Omega$, 25°C | 0.013% | | | 0.013% | | | |
| B_1 Unity-gain bandwidth | $V_I = 10\text{ mV}$, $C_L = 25\text{ pF}$, $R_L = 2\text{ k}\Omega$, See Figure 2 | 25°C | 9.4 | | | 9.4 | | | MHz | |
| B_{OM} Maximum output-swing bandwidth | $V_{O(PP)} = 4\text{ V}$, $R_L = 2\text{ k}\Omega$, $C_L = 25\text{ pF}$ | $A_{VD} = -1$, 25°C | 2.8 | | | 2.8 | | | MHz | |
| ϕ_m Phase margin at unity gain | $V_I = 10\text{ mV}$, $C_L = 25\text{ pF}$, $R_L = 2\text{ k}\Omega$, See Figure 2 | 25°C | 56° | | | 56° | | | | |

† Full range is -55°C to 125°C .

‡ *On products compliant to MIL-PRF-38535, Class B, this parameter is not production tested.



TLE207x, TLE207xA
EXCALIBUR LOW-NOISE HIGH-SPEED
JFET-INPUT OPERATIONAL AMPLIFIERS

SLOS181C – FEBRUARY 1997 – REVISED DECEMBER 2009

TLE2071M electrical characteristics at specified free-air temperature, $V_{CC\pm} = \pm 15$ V (unless otherwise noted)

| PARAMETER | TEST CONDITIONS | T_A † | TLE2071M | | | TLE2071AM | | | UNIT | |
|-------------------------------------------------------------------------------|----------------------------------------------------------------------------------------|----------------------------|-------------|-------------|-----|-------------|-------------|------------------------------|----------|----|
| | | | MIN | TYP | MAX | MIN | TYP | MAX | | |
| V_{IO} Input offset voltage | $V_{IC} = 0,$ $R_S = 50 \Omega$ $V_O = 0,$ | 25°C | 0.49 | 4 | | 0.47 | 2 | mV | | |
| | | Full range | | | 9.2 | | 7.2 | | | |
| α_{VIO} Temperature coefficient of input offset voltage | | Full range | 3.2 | 29* | | 3.2 | 29* | $\mu\text{V}/^\circ\text{C}$ | | |
| I_{IO} Input offset current | $V_{IC} = 0,$ $V_O = 0,$ See Figure 4 | 25°C | 6 | 100 | | 6 | 100 | pA | | |
| | | Full range | | | 20 | | 20 | nA | | |
| I_{IB} Input bias current | | 25°C | 20 | 175 | | 20 | 175 | pA | | |
| | | Full range | | | 60 | | 60 | nA | | |
| V_{ICR} Common-mode input voltage range | $R_S = 50 \Omega$ | 25°C | 15 to -11 | 15 to -11.9 | | 15 to -11 | 15 to -11.9 | V | | |
| | | Full range | 15 to -10.9 | | | 15 to -10.9 | | | | |
| V_{OM+} Maximum positive peak output voltage swing | $I_O = -200 \mu\text{A}$ | 25°C | 13.8 | 14.1 | | 13.8 | 14.1 | V | | |
| | | Full range | 13.6 | | | 13.6 | | | | |
| | $I_O = -2 \text{ mA}$ | 25°C | 13.5 | 13.9 | | 13.5 | 13.9 | | | |
| | | Full range | 13.3 | | | 13.3 | | | | |
| | $I_O = -20 \text{ mA}$ | 25°C | 11.5 | 12.3 | | 11.5 | 12.3 | | | |
| | | Full range | 11.4 | | | 11.4 | | | | |
| V_{OM-} Maximum negative peak output voltage swing | $I_O = 200 \mu\text{A}$ | 25°C | -13.8 | -14.2 | | -13.8 | -14.2 | V | | |
| | | Full range | -13.6 | | | -13.6 | | | | |
| | $I_O = 2 \text{ mA}$ | 25°C | -13.5 | -14 | | -13.5 | -14 | | | |
| | | Full range | -13.3 | | | -13.3 | | | | |
| | $I_O = 20 \text{ mA}$ | 25°C | -11.5 | -12.4 | | -11.5 | -12.4 | | | |
| | | Full range | -11.4 | | | -11.4 | | | | |
| A_{VD} Large-signal differential voltage amplification | $V_O = \pm 10 \text{ V}$ | $R_L = 600 \Omega$ | 25°C | 80 | 96 | | 80 | 96 | dB | |
| | | | Full range | 78 | | | 78 | | | |
| | | $R_L = 2 \text{ k}\Omega$ | 25°C | 90 | 109 | | 90 | 109 | | |
| | | | Full range | 88 | | | 88 | | | |
| | | $R_L = 10 \text{ k}\Omega$ | 25°C | 95 | 118 | | 95 | 118 | | |
| | | | Full range | 93 | | | 93 | | | |
| r_i Input resistance | $V_{IC} = 0$ | 25°C | 10^{12} | | | 10^{12} | | | Ω | |
| c_i Input capacitance | $V_{IC} = 0,$ See Figure 5 | Common mode | 25°C | 7.5 | | | 7.5 | | | pF |
| | | Differential | 25°C | 2.5 | | | 2.5 | | | |
| z_o Open-loop output impedance | $f = 1 \text{ MHz}$ | 25°C | 80 | | | 80 | | | Ω | |
| CMRR Common-mode rejection ratio | $V_{IC} = V_{ICRmin},$ $V_O = 0,$ $R_S = 50 \Omega$ | 25°C | 80 | 98 | | 80 | 98 | dB | | |
| | | Full range | 78 | | | 78 | | | | |
| k_{SVR} Supply-voltage rejection ratio ($\Delta V_{CC\pm}/\Delta V_{IO}$) | $V_{CC\pm} = \pm 5 \text{ V to } \pm 15 \text{ V},$ $V_O = 0,$ $R_S = 50 \Omega$ | 25°C | 82 | 99 | | 82 | 99 | dB | | |
| | | Full range | 80 | | | 80 | | | | |

*On products compliant to MIL-PRF-38535, Class B, this parameter is not production tested.

† Full range is -55°C to 125°C .



TLE207x, TLE207xA EXCALIBUR LOW-NOISE HIGH-SPEED JFET-INPUT OPERATIONAL AMPLIFIERS

SLOS181C – FEBRUARY 1997 – REVISED DECEMBER 2009

TLE2071M electrical characteristics at specified free-air temperature, $V_{CC\pm} = \pm 15$ V (unless otherwise noted) (continued)

| PARAMETER | TEST CONDITIONS | T_A † | TLE2071M | | | TLE2071AM | | | UNIT |
|---------------------------------------|---------------------|-----------------|----------|-----|-----|-----------|-----|-----|------|
| | | | MIN | TYP | MAX | MIN | TYP | MAX | |
| I_{CC} Supply current | $V_O = 0$, No load | 25°C | 1.35 | 1.7 | 2.2 | 1.35 | 1.7 | 2.2 | mA |
| | | Full range | 2.2 | | | 2.2 | | | |
| I_{OS} Short-circuit output current | $V_O = 0$ | $V_{ID} = 1$ V | -30 | -45 | | -30 | -45 | | mA |
| | | $V_{ID} = -1$ V | 30 | 48 | | 30 | 48 | | |

† Full range is -55°C to 125°C .

TLE2071M operating characteristics at specified free-air temperature, $V_{CC\pm} = \pm 15$ V

| PARAMETER | TEST CONDITIONS | T_A † | TLE2071M | | | TLE2071AM | | | UNIT | |
|---------------------------------------------------------|--------------------------------------------------------------------------------------------------|----------------------------------------|----------|--------|-----|-----------|--------|-----|------------------------|--|
| | | | MIN | TYP | MAX | MIN | TYP | MAX | | |
| SR+ Positive slew rate | $V_{O(PP)} = 10$ V, $A_{VD} = -1$, $R_L = 2$ k Ω , $C_L = 100$ pF, See Figure 1 | 25°C | 30 | 40 | | 30 | 40 | | V/ μ s | |
| | | Full range | 22 | | | 22 | | | | |
| SR- Negative slew rate | | 25°C | 30 | 45 | | 30 | 45 | | V/ μ s | |
| | | Full range | 22 | | | 22 | | | | |
| t_s Settling time | $A_{VD} = -1$, 10-V step, $R_L = 1$ k Ω , $C_L = 100$ pF | To 10 mV | 0.4 | | | 0.4 | | | μ s | |
| | | To 1 mV | 1.5 | | | 1.5 | | | | |
| V_n Equivalent input noise voltage | $R_S = 20$ Ω , See Figure 3 | f = 10 Hz | 48 | 85* | | 48 | 85* | | nV/ $\sqrt{\text{Hz}}$ | |
| | | f = 10 kHz | 12 | 17* | | 12 | 17* | | | |
| $V_{N(PP)}$ Peak-to-peak equivalent input noise voltage | | f = 10 Hz to 10 kHz | 6 | | | 6 | | | μ V | |
| | | f = 0.1 Hz to 10 Hz | 0.6 | | | 0.6 | | | | |
| I_n Equivalent input noise current | $V_{IC} = 0$, f = 10 kHz | 25°C | 2.8 | | | 2.8 | | | fA/ $\sqrt{\text{Hz}}$ | |
| THD + N Total harmonic distortion plus noise | $V_{O(PP)} = 20$ V, f = 1 kHz, $R_S = 25$ Ω | $A_{VD} = 10$, $R_L = 2$ k Ω | 25°C | 0.008% | | | 0.008% | | | |
| B_1 Unity-gain bandwidth | $V_I = 10$ mV, $C_L = 25$ pF, | $R_L = 2$ k Ω , See Figure 2 | 25°C | 8* | 10 | | 8* | 10 | MHz | |
| B_{OM} Maximum output-swing bandwidth | $V_{O(PP)} = 20$ V, $R_L = 2$ k Ω , | $A_{VD} = -1$, $C_L = 25$ pF | 25°C | 478* | 637 | | 478* | 637 | kHz | |
| ϕ_m Phase margin at unity gain | $V_I = 10$ mV, $C_L = 25$ pF, | $R_L = 2$ k Ω , See Figure 2 | 25°C | 57° | | | 57° | | | |

*On products compliant to MIL-PRF-38535, Class B, this parameter is not production tested.

† Full range is -55°C to 125°C .



TLE207x, TLE207xA
EXCALIBUR LOW-NOISE HIGH-SPEED
JFET-INPUT OPERATIONAL AMPLIFIERS

SLOS181C – FEBRUARY 1997 – REVISED DECEMBER 2009

TLE2071Y electrical characteristics at $V_{CC\pm} = \pm 15\text{ V}$, $T_A = 25^\circ\text{C}$

| PARAMETER | TEST CONDITIONS | TLE2071Y | | | UNIT |
|-------------------------------------------------------------------------------|------------------------------------------------------------------------------------------|----------------------------|------------------|-----|----------|
| | | MIN | TYP | MAX | |
| V_{IO} Input offset voltage | $V_{IC} = 0$, $V_O = 0$, $R_S = 50\ \Omega$ | | 0.49 | 4 | mV |
| I_{IO} Input offset current | $V_{IC} = 0$, $V_O = 0$, See Figure 4 | | 6 | 100 | pA |
| I_{IB} Input bias current | | | 20 | 175 | pA |
| V_{ICR} Common-mode input voltage range | $R_S = 50\ \Omega$ | 15 to -11 | 15 to 11.9 | | V |
| V_{OM+} Maximum positive peak output voltage swing | $I_O = -200\ \mu\text{A}$ | 13.8 | 14.1 | | V |
| | $I_O = -2\ \text{mA}$ | 13.5 | 13.9 | | |
| | $I_O = -20\ \text{mA}$ | 11.5 | 12.3 | | |
| V_{OM-} Maximum negative peak output voltage swing | $I_O = 200\ \mu\text{A}$ | -13.8 | -14.2 | | V |
| | $I_O = 2\ \text{mA}$ | -13.5 | -14 | | |
| | $I_O = 20\ \text{mA}$ | -11.5 | -12.4 | | |
| A_{VD} Large-signal differential voltage amplification | $V_O = \pm 10\ \text{V}$ | $R_L = 600\ \Omega$ | 80 | 96 | dB |
| | | $R_L = 2\ \text{k}\Omega$ | 90 | 109 | |
| | | $R_L = 10\ \text{k}\Omega$ | 95 | 118 | |
| r_i Input resistance | $V_{IC} = 0$ | 10^{12} | | | Ω |
| c_i Input capacitance | $V_O = 0$, See Figure 5 | Common mode | 7.5 | | pF |
| | | Differential | 2.5 | | |
| z_o Open-loop output impedance | $f = 1\ \text{MHz}$ | 80 | | | Ω |
| CMRR Common-mode rejection ratio | $V_{IC} = V_{ICRmin}$, $R_S = 50\ \Omega$, $V_O = 0$, | 80 | 98 | | dB |
| k_{SVR} Supply-voltage rejection ratio ($\Delta V_{CC\pm}/\Delta V_{IO}$) | $V_{CC\pm} = \pm 5\ \text{V to } \pm 15\ \text{V}$, $R_S = 50\ \Omega$, $V_O = 0$, | 82 | 99 | | dB |
| I_{CC} Supply current | $V_O = 0$, No load | 1.35 | 1.7 | 2.2 | mA |
| I_{OS} Short-circuit output current | $V_O = 0$ | $V_{ID} = 1\ \text{V}$ | -30 | -45 | mA |
| | | $V_{ID} = -1\ \text{V}$ | 30 | 48 | |

TLE207x, TLE207xA
EXCALIBUR LOW-NOISE HIGH-SPEED
JFET-INPUT OPERATIONAL AMPLIFIERS

SLOS181C – FEBRUARY 1997 – REVISED DECEMBER 2009

TLE2072C electrical characteristics at specified free-air temperature, $V_{CC\pm} = \pm 5\text{ V}$ (unless otherwise noted)

| PARAMETER | TEST CONDITIONS | T_A † | TLE2072C | | | TLE2072AC | | | UNIT | |
|---------------------------------------------------------------------------------|------------------------------------------------------------------------------------|----------------------------|------------|-----------|------|-----------|-----------|------------------------------|----------|----|
| | | | MIN | TYP | MAX | MIN | TYP | MAX | | |
| V_{IO} Input offset voltage | $V_{IC} = 0, V_O = 0,$ $R_S = 50\ \Omega$ | 25°C | 0.9 | 6 | | 0.65 | 3.5 | mV | | |
| | | Full range | | | 7.8 | | 5.3 | | | |
| α_{VIO} Temperature coefficient of input offset voltage | | Full range | 2.3 | 25 | | 2.3 | 25 | $\mu\text{V}/^\circ\text{C}$ | | |
| I_{IO} Input offset current | $V_{IC} = 0, V_O = 0,$ See Figure 4 | 25°C | 5 | 100 | | 5 | 100 | pA | | |
| | | Full range | | | 1.4 | | 1.4 | nA | | |
| I_{IB} Input bias current | | 25°C | 15 | 175 | | 15 | 175 | pA | | |
| | | Full range | | | 5 | | 5 | nA | | |
| V_{ICR} Common-mode input voltage range | $R_S = 50\ \Omega$ | 25°C | 5 to -1 | 5 to -1.9 | | 5 to -1 | 5 to -1.9 | V | | |
| | | Full range | 5 to -0.9 | | | 5 to -0.9 | | | | |
| V_{OM+} Maximum positive peak output voltage swing | $I_O = -200\ \mu\text{A}$ | 25°C | 3.8 | 4.1 | | 3.8 | 4.1 | V | | |
| | | Full range | 3.7 | | | 3.7 | | | | |
| | $I_O = -2\ \text{mA}$ | 25°C | 3.5 | 3.9 | | 3.5 | 3.9 | | | |
| | | Full range | 3.4 | | | 3.4 | | | | |
| $I_O = -20\ \text{mA}$ | 25°C | 1.5 | 2.3 | | 1.5 | 2.3 | | | | |
| | Full range | 1.5 | | | 1.5 | | | | | |
| V_{OM-} Maximum negative peak output voltage swing | $I_O = 200\ \mu\text{A}$ | 25°C | -3.8 | -4.2 | | -3.8 | -4.2 | V | | |
| | | Full range | -3.7 | | | -3.7 | | | | |
| | $I_O = 2\ \text{mA}$ | 25°C | -3.5 | -4.1 | | -3.5 | -4.1 | | | |
| | | Full range | -3.4 | | | -3.4 | | | | |
| $I_O = 20\ \text{mA}$ | 25°C | -1.5 | -2.4 | | -1.5 | -2.4 | | | | |
| | Full range | -1.5 | | | -1.5 | | | | | |
| A_{VD} Large-signal differential voltage amplification | $V_O = \pm 2.3\ \text{V}$ | $R_L = 600\ \Omega$ | 25°C | 80 | 91 | | 80 | 91 | dB | |
| | | | Full range | 79 | | | 79 | | | |
| | | $R_L = 2\ \text{k}\Omega$ | 25°C | 90 | 100 | | 90 | 100 | | |
| | | | Full range | 89 | | | 89 | | | |
| | | $R_L = 10\ \text{k}\Omega$ | 25°C | 95 | 106 | | 95 | 106 | | |
| | | | Full range | 94 | | | 94 | | | |
| r_i Input resistance | $V_{IC} = 0$ | 25°C | 10^{12} | | | 10^{12} | | | Ω | |
| c_i Input capacitance | $V_{IC} = 0,$ See Figure 5 | Common mode | 25°C | 11 | | | 11 | | | pF |
| | | Differential | 25°C | 2.5 | | | 2.5 | | | |
| z_o Open-loop output impedance | $f = 1\ \text{MHz}$ | 25°C | 80 | | | 80 | | | Ω | |
| CMRR Common-mode rejection ratio | $V_{IC} = V_{ICRmin},$ $V_O = 0, R_S = 50\ \Omega$ | 25°C | 70 | 89 | | 70 | 89 | dB | | |
| | | Full range | 68 | | | 68 | | | | |
| k_{SVR} Supply-voltage rejection ratio ($\Delta V_{CC\pm} / \Delta V_{IO}$) | $V_{CC\pm} = \pm 5\ \text{V to } \pm 15\ \text{V},$ $V_O = 0, R_S = 50\ \Omega$ | 25°C | 82 | 99 | | 82 | 99 | dB | | |
| | | Full range | 80 | | | 80 | | | | |

† Full range is 0°C to 70°C.



TLE207x, TLE207xA
EXCALIBUR LOW-NOISE HIGH-SPEED
JFET-INPUT OPERATIONAL AMPLIFIERS

SLOS181C – FEBRUARY 1997 – REVISED DECEMBER 2009

TLE2072C electrical characteristics at specified free-air temperature, $V_{CC\pm} = \pm 5\text{ V}$ (unless otherwise noted)
(continued)

| PARAMETER | TEST CONDITIONS | T_A | TLE2072C | | | TLE2072AC | | | UNIT | |
|-----------|--------------------------------|-----------------------------------------|------------------------|-----|-----|-----------|-----|-----|------|----|
| | | | MIN | TYP | MAX | MIN | TYP | MAX | | |
| I_{CC} | Supply current (both channels) | $V_O = 0$, No load | 25°C | 2.7 | 2.9 | 3.9 | 2.7 | 2.9 | 3.9 | mA |
| | | | Full range | 3.9 | | | 3.9 | | | |
| a_x | Crosstalk attenuation | $V_{IC} = 0$, $R_L = 2\text{ k}\Omega$ | 25°C | 120 | | | 120 | | | dB |
| I_{OS} | Short-circuit output current | $V_O = 0$ | $V_{ID} = 1\text{ V}$ | -35 | | | -35 | | | mA |
| | | | $V_{ID} = -1\text{ V}$ | 45 | | | 45 | | | |

TLE2072C operating characteristics at specified free-air temperature, $V_{CC\pm} = \pm 5\text{ V}$

| PARAMETER | TEST CONDITIONS | T_A † | TLE2072C | | | TLE2072AC | | | UNIT | |
|-------------|---------------------------------------------|------------------------------------------------------------------------------------------------------------------------------|---------------------|--------|-----|-----------|--------|-----|------|------------------------------|
| | | | MIN | TYP | MAX | MIN | TYP | MAX | | |
| SR+ | Positive slew rate | $V_{O(PP)} = \pm 2.3\text{ V}$, $A_{VD} = -1$, $C_L = 100\text{ pF}$, $R_L = 2\text{ k}\Omega$, See Figure 1 | 25°C | 35 | | | 35 | | | $\text{V}/\mu\text{s}$ |
| | | | Full range | 22 | | | 22 | | | |
| SR- | Negative slew rate | $V_{O(PP)} = \pm 2.3\text{ V}$, $A_{VD} = -1$, $C_L = 100\text{ pF}$, $R_L = 2\text{ k}\Omega$, See Figure 1 | 25°C | 38 | | | 38 | | | $\text{V}/\mu\text{s}$ |
| | | | Full range | 22 | | | 22 | | | |
| t_s | Settling time | $A_{VD} = -1$, 2-V step, $R_L = 1\text{ k}\Omega$, $C_L = 100\text{ pF}$ | To 10 mV | 0.25 | | | 0.25 | | | μs |
| | | | To 1 mV | 0.4 | | | 0.4 | | | |
| V_n | Equivalent input noise voltage | $R_S = 20\ \Omega$, See Figure 3 | f = 10 Hz | 48 | 85 | | 48 | 85 | | $\text{nV}/\sqrt{\text{Hz}}$ |
| | | | f = 10 kHz | 12 | 17 | | 12 | 17 | | |
| $V_{N(PP)}$ | Peak-to-peak equivalent input noise voltage | $R_S = 20\ \Omega$, See Figure 3 | f = 10 Hz to 10 kHz | 6 | | | 6 | | | μV |
| | | | f = 0.1 Hz to 10 Hz | 0.6 | | | 0.6 | | | |
| I_n | Equivalent input noise current | $V_{IC} = 0$, f = 10 kHz | 25°C | 2.8 | | | 2.8 | | | $\text{fA}/\sqrt{\text{Hz}}$ |
| THD + N | Total harmonic distortion plus noise | $V_{O(PP)} = 5\text{ V}$, f = 1 kHz, $R_S = 25\ \Omega$ | 25°C | 0.013% | | | 0.013% | | | |
| B_1 | Unity-gain bandwidth | $V_I = 10\text{ mV}$, $C_L = 25\text{ pF}$, $R_L = 2\text{ k}\Omega$, See Figure 2 | 25°C | 9.4 | | | 9.4 | | | MHz |
| B_{OM} | Maximum output-swing bandwidth | $V_{O(PP)} = 4\text{ V}$, $R_L = 2\text{ k}\Omega$, $A_{VD} = -1$, $C_L = 25\text{ pF}$ | 25°C | 2.8 | | | 2.8 | | | MHz |
| ϕ_m | Phase margin at unity gain | $V_I = 10\text{ mV}$, $C_L = 25\text{ pF}$, $R_L = 2\text{ k}\Omega$, See Figure 2 | 25°C | 56° | | | 56° | | | |

† Full range is 0°C to 70°C.



TLE207x, TLE207xA
EXCALIBUR LOW-NOISE HIGH-SPEED
JFET-INPUT OPERATIONAL AMPLIFIERS

SLOS181C – FEBRUARY 1997 – REVISED DECEMBER 2009

TLE2072C electrical characteristics at specified free-air temperature, $V_{CC\pm} = \pm 15\text{ V}$ (unless otherwise noted)

| PARAMETER | TEST CONDITIONS | T_A † | TLE2072C | | | TLE2072AC | | | UNIT | |
|-------------------------------------------------------------------------------|-----------------------------------------------------------------------------------------|----------------------------|-------------|-------------|-------|-------------|-------------|------------------------------|----------|----|
| | | | MIN | TYP | MAX | MIN | TYP | MAX | | |
| V_{IO} Input offset voltage | $V_{IC} = 0,$ $R_S = 50\ \Omega$ $V_O = 0,$ | 25°C | 1.1 | 6 | | 0.7 | 3.5 | mV | | |
| | | Full range | | | 7.8 | | 5.3 | | | |
| α_{VIO} Temperature coefficient of input offset voltage | | Full range | 2.4 | 25 | | 2.4 | 25 | $\mu\text{V}/^\circ\text{C}$ | | |
| I_{IO} Input offset current | $V_{IC} = 0,$ $V_O = 0,$ See Figure 4 | 25°C | 6 | 100 | | 6 | 100 | pA | | |
| | | Full range | | | 1.4 | | 1.4 | nA | | |
| I_{IB} Input bias current | | 25°C | 20 | 175 | | 20 | 175 | pA | | |
| | | Full range | | | 5 | | 5 | nA | | |
| V_{ICR} Common-mode input voltage range | $R_S = 50\ \Omega$ | 25°C | 15 to -11 | 15 to -11.9 | | 15 to -11 | 15 to -11.9 | V | | |
| | | Full range | 15 to -10.9 | | | 15 to -10.9 | | | | |
| V_{OM+} Maximum positive peak output voltage swing | $I_O = -200\ \mu\text{A}$ | 25°C | 13.8 | 14.1 | | 13.8 | 14.1 | V | | |
| | | Full range | 13.6 | | | 13.6 | | | | |
| | $I_O = -2\ \text{mA}$ | 25°C | 13.5 | 13.9 | | 13.5 | 13.9 | | | |
| | | Full range | 13.4 | | | 13.4 | | | | |
| $I_O = -20\ \text{mA}$ | 25°C | 11.5 | 12.3 | | 11.5 | 12.3 | | | | |
| | Full range | 11.5 | | | 11.5 | | | | | |
| V_{OM-} Maximum negative peak output voltage swing | $I_O = 200\ \mu\text{A}$ | 25°C | -13.8 | -14.2 | | -13.8 | -14.2 | V | | |
| | | Full range | -13.7 | | | -13.7 | | | | |
| | $I_O = 2\ \text{mA}$ | 25°C | -13.5 | -14 | | -13.5 | -14 | | | |
| | | Full range | -13.4 | | | -13.4 | | | | |
| $I_O = 20\ \text{mA}$ | 25°C | -11.5 | -12.4 | | -11.5 | -12.4 | | | | |
| | Full range | -11.5 | | | -11.5 | | | | | |
| A_{VD} Large-signal differential voltage amplification | $V_O = \pm 10\ \text{V}$ | $R_L = 600\ \Omega$ | 25°C | 80 | 96 | | 80 | 96 | dB | |
| | | | Full range | 79 | | | 79 | | | |
| | | $R_L = 2\ \text{k}\Omega$ | 25°C | 90 | 109 | | 90 | 109 | | |
| | | | Full range | 89 | | | 89 | | | |
| | | $R_L = 10\ \text{k}\Omega$ | 25°C | 95 | 118 | | 95 | 118 | | |
| | | | Full range | 94 | | | 94 | | | |
| r_i Input resistance | $V_{IC} = 0$ | 25°C | 10^{12} | | | 10^{12} | | | Ω | |
| c_i Input capacitance | $V_{IC} = 0,$ See Figure 5 | Common mode | 25°C | 7.5 | | | 7.5 | | | pF |
| | | Differential | 25°C | 2.5 | | | 2.5 | | | |
| z_o Open-loop output impedance | $f = 1\ \text{MHz}$ | 25°C | 80 | | | 80 | | | Ω | |
| CMRR Common-mode rejection ratio | $V_{IC} = V_{ICRmin},$ $V_O = 0,$ $R_S = 50\ \Omega$ | 25°C | 80 | 98 | | 80 | 98 | dB | | |
| | | Full range | 79 | | | 79 | | | | |
| k_{SVR} Supply-voltage rejection ratio ($\Delta V_{CC\pm}/\Delta V_{IO}$) | $V_{CC\pm} = \pm 5\ \text{V to } \pm 15\ \text{V},$ $V_O = 0,$ $R_S = 50\ \Omega$ | 25°C | 82 | 99 | | 82 | 99 | dB | | |
| | | Full range | 81 | | | 81 | | | | |

† Full range is 0°C to 70°C.



TLE207x, TLE207xA
EXCALIBUR LOW-NOISE HIGH-SPEED
JFET-INPUT OPERATIONAL AMPLIFIERS

SLOS181C – FEBRUARY 1997 – REVISED DECEMBER 2009

TLE2072C electrical characteristics at specified free-air temperature, $V_{CC\pm} = \pm 15$ V (unless otherwise noted) (continued)

| PARAMETER | TEST CONDITIONS | T_A | TLE2072C | | | TLE2072AC | | | UNIT | |
|-----------|--------------------------------|-------------------------------------|------------|-----------------|-----|-----------|-----|-----|------|----|
| | | | MIN | TYP | MAX | MIN | TYP | MAX | | |
| I_{CC} | Supply current (both channels) | $V_O = 0$, No load | 25°C | 2.7 | 3.1 | 3.9 | 2.7 | 3.1 | 3.9 | mA |
| | | | Full range | 3.9 | | | 3.9 | | | |
| a_x | Crosstalk attenuation | $V_{IC} = 0$, $R_L = 2$ k Ω | 25°C | 120 | | | 120 | | | dB |
| I_{OS} | Short-circuit output current | $V_O = 0$ | 25°C | $V_{ID} = 1$ V | -30 | -45 | -30 | -45 | mA | |
| | | | | $V_{ID} = -1$ V | 30 | 48 | 30 | 48 | | |

TLE2072C operating characteristics at specified free-air temperature, $V_{CC\pm} = \pm 15$ V

| PARAMETER | TEST CONDITIONS | T_A † | TLE2072C | | | TLE2072AC | | | UNIT | |
|-------------|---------------------------------------------|-----------------------------------------------------------------------------------------------------|---------------------|--------|-----|-----------|--------|-----|-----------------|-----------------|
| | | | MIN | TYP | MAX | MIN | TYP | MAX | | |
| SR+ | Positive slew rate | $V_{O(PP)} = 10$ V, $A_{VD} = -1$, $C_L = 100$ pF, $R_L = 2$ k Ω , See Figure 1 | 25°C | 28 | 40 | | 28 | 40 | V/ μ s | |
| | | | Full range | 25 | | | 25 | | | |
| SR- | Negative slew rate | $V_{O(PP)} = 10$ V, $A_{VD} = -1$, $C_L = 100$ pF, $R_L = 2$ k Ω , See Figure 1 | 25°C | 30 | 45 | | 30 | 45 | V/ μ s | |
| | | | Full range | 25 | | | 25 | | | |
| t_s | Settling time | $A_{VD} = -1$, 10-V step, $R_L = 1$ k Ω , $C_L = 100$ pF | To 10 mV | 0.4 | | | 0.4 | | | μ s |
| | | | To 1 mV | 1.5 | | | 1.5 | | | |
| V_n | Equivalent input noise voltage | $R_S = 20$ Ω , See Figure 3 | f = 10 Hz | 48 | 85 | | 48 | 85 | nV/ \sqrt{Hz} | |
| | | | f = 10 kHz | 12 | 17 | | 12 | 17 | | |
| $V_{N(PP)}$ | Peak-to-peak equivalent input noise voltage | $R_S = 20$ Ω , See Figure 3 | f = 10 Hz to 10 kHz | 6 | | | 6 | | | μ V |
| | | | f = 0.1 Hz to 10 Hz | 0.6 | | | 0.6 | | | |
| I_n | Equivalent input noise current | $V_{IC} = 0$, f = 10 kHz | 25°C | 2.8 | | | 2.8 | | | fA/ \sqrt{Hz} |
| THD + N | Total harmonic distortion plus noise | $V_{O(PP)} = 20$ V, f = 1 kHz, $R_S = 25$ Ω | 25°C | 0.008% | | | 0.008% | | | |
| B_1 | Unity-gain bandwidth | $V_I = 10$ mV, $C_L = 25$ pF, $R_L = 2$ k Ω , See Figure 2 | 25°C | 8 | 10 | | 8 | 10 | MHz | |
| B_{OM} | Maximum output-swing bandwidth | $V_{O(PP)} = 20$ V, $R_L = 2$ k Ω , $A_{VD} = -1$, $C_L = 25$ pF | 25°C | 478 | 637 | | 478 | 637 | kHz | |
| ϕ_m | Phase margin at unity gain | $V_I = 10$ mV, $C_L = 25$ pF, $R_L = 2$ k Ω , See Figure 2 | 25°C | 57° | | | 57° | | | |

† Full range is 0°C to 70°C.

TLE207x, TLE207xA EXCALIBUR LOW-NOISE HIGH-SPEED JFET-INPUT OPERATIONAL AMPLIFIERS

SLOS181C – FEBRUARY 1997 – REVISED DECEMBER 2009

TLE2072I electrical characteristics at specified free-air temperature, $V_{CC\pm} = \pm 5\text{ V}$ (unless otherwise noted)

| PARAMETER | TEST CONDITIONS | T_A † | TLE2072I | | | TLE2072AI | | | UNIT | |
|-------------------------------------------------------------------------------|------------------------------------------------------------------------------------|----------------------------|------------|-----------|-----|-----------|-----------|------------------------------|----------|----|
| | | | MIN | TYP | MAX | MIN | TYP | MAX | | |
| V_{IO} Input offset voltage | $V_{IC} = 0, V_O = 0,$ $R_S = 50\ \Omega$ | 25°C | 0.9 | 6 | | 0.65 | 3.5 | mV | | |
| | | Full range | | | 9.1 | | 6.4 | | | |
| α_{VIO} Temperature coefficient of input offset voltage | | Full range | 2.4 | 25 | | 2.4 | 25 | $\mu\text{V}/^\circ\text{C}$ | | |
| I_{IO} Input offset current | $V_{IC} = 0, V_O = 0,$ See Figure 4 | 25°C | 5 | 100 | | 5 | 100 | pA | | |
| | | Full range | | | 5 | | 5 | nA | | |
| I_{IB} Input bias current | | 25°C | 15 | 175 | | 15 | 175 | pA | | |
| | | Full range | | | 10 | | 10 | nA | | |
| V_{ICR} Common-mode input voltage range | $R_S = 50\ \Omega$ | 25°C | 5 to -1 | 5 to -1.9 | | 5 to -1 | 5 to -1.9 | V | | |
| | | Full range | 5 to -0.8 | | | 5 to -0.8 | | | | |
| V_{OM+} Maximum positive peak output voltage swing | $I_O = -200\ \mu\text{A}$ | 25°C | 3.8 | 4.1 | | 3.8 | 4.1 | V | | |
| | | Full range | 3.7 | | | 3.7 | | | | |
| | $I_O = -2\ \text{mA}$ | 25°C | 3.5 | 3.9 | | 3.5 | 3.9 | | | |
| | | Full range | 3.4 | | | 3.4 | | | | |
| | $I_O = -20\ \text{mA}$ | 25°C | 1.5 | 2.3 | | 1.5 | 2.3 | | | |
| | | Full range | 1.5 | | | 1.5 | | | | |
| V_{OM-} Maximum negative peak output voltage swing | $I_O = 200\ \mu\text{A}$ | 25°C | -3.8 | -4.2 | | -3.8 | -4.2 | V | | |
| | | Full range | -3.7 | | | -3.7 | | | | |
| | $I_O = 2\ \text{mA}$ | 25°C | -3.5 | -4.1 | | -3.5 | -4.1 | | | |
| | | Full range | -3.4 | | | -3.4 | | | | |
| | $I_O = 20\ \text{mA}$ | 25°C | -1.5 | -2.4 | | -1.5 | -2.4 | | | |
| | | Full range | -1.5 | | | -1.5 | | | | |
| A_{VD} Large-signal differential voltage amplification | $V_O = \pm 2.3\ \text{V}$ | $R_L = 600\ \Omega$ | 25°C | 80 | 91 | | 80 | 91 | dB | |
| | | | Full range | 79 | | | 79 | | | |
| | | $R_L = 2\ \text{k}\Omega$ | 25°C | 90 | 100 | | 90 | 100 | | |
| | | | Full range | 89 | | | 89 | | | |
| | | $R_L = 10\ \text{k}\Omega$ | 25°C | 95 | 106 | | 95 | 106 | | |
| | | | Full range | 94 | | | 94 | | | |
| r_i Input resistance | $V_{IC} = 0$ | 25°C | 10^{12} | | | 10^{12} | | | Ω | |
| c_i Input capacitance | $V_{IC} = 0,$ See Figure 5 | Common mode | 25°C | 11 | | | 11 | | | pF |
| | | Differential | 25°C | 2.5 | | | 2.5 | | | |
| z_o Open-loop output impedance | $f = 1\ \text{MHz}$ | 25°C | 80 | | | 80 | | | Ω | |
| CMRR Common-mode rejection ratio | $V_{IC} = V_{ICRmin},$ $V_O = 0, R_S = 50\ \Omega$ | 25°C | 70 | 89 | | 70 | 89 | dB | | |
| | | Full range | 68 | | | 68 | | | | |
| k_{SVR} Supply-voltage rejection ratio ($\Delta V_{CC\pm}/\Delta V_{IO}$) | $V_{CC\pm} = \pm 5\ \text{V to } \pm 15\ \text{V},$ $V_O = 0, R_S = 50\ \Omega$ | 25°C | 82 | 99 | | 82 | 99 | dB | | |
| | | Full range | 80 | | | 80 | | | | |

† Full range is -40°C to 85°C .



TLE207x, TLE207xA
EXCALIBUR LOW-NOISE HIGH-SPEED
JFET-INPUT OPERATIONAL AMPLIFIERS

SLOS181C – FEBRUARY 1997 – REVISED DECEMBER 2009

TLE2072I electrical characteristics at specified free-air temperature, $V_{CC\pm} = \pm 5\text{ V}$ (unless otherwise noted) (continued)

| PARAMETER | TEST CONDITIONS | T_A | TLE2072I | | | TLE2072AI | | | UNIT | |
|-----------|--------------------------------|-----------------------------------------|------------------------|-----|-----|-----------|-----|-----|------|----|
| | | | MIN | TYP | MAX | MIN | TYP | MAX | | |
| I_{CC} | Supply current (both channels) | $V_O = 0$, No load | 25°C | 2.7 | 2.9 | 3.9 | 2.7 | 2.9 | 3.9 | mA |
| | | | Full range | 3.9 | | | 3.9 | | | |
| a_x | Crosstalk attenuation | $V_{IC} = 0$, $R_L = 2\text{ k}\Omega$ | 25°C | 120 | | | 120 | | | dB |
| I_{OS} | Short-circuit output current | $V_O = 0$ | $V_{ID} = 1\text{ V}$ | -35 | | | -35 | | | mA |
| | | | $V_{ID} = -1\text{ V}$ | 45 | | | 45 | | | |

TLE2072I operating characteristics at specified free-air temperature, $V_{CC\pm} = \pm 5\text{ V}$

| PARAMETER | TEST CONDITIONS | T_A † | TLE2072I | | | TLE2072AI | | | UNIT | |
|-------------|---------------------------------------------|------------------------------------------------------------------------------------------------------------------------------|-------------------------------------------------------|--------|-----|-----------|--------|-----|------|------------------------|
| | | | MIN | TYP | MAX | MIN | TYP | MAX | | |
| SR+ | Positive slew rate | $V_{O(PP)} = \pm 2.3\text{ V}$, $A_{VD} = -1$, $C_L = 100\text{ pF}$, $R_L = 2\text{ k}\Omega$, See Figure 1 | 25°C | 35 | | | 35 | | | V/ μ s |
| | | | Full range | 20 | | | 20 | | | |
| SR- | Negative slew rate | $V_{O(PP)} = \pm 2.3\text{ V}$, $A_{VD} = -1$, $C_L = 100\text{ pF}$, $R_L = 2\text{ k}\Omega$, See Figure 1 | 25°C | 38 | | | 38 | | | V/ μ s |
| | | | Full range | 20 | | | 20 | | | |
| t_s | Settling time | $A_{VD} = -1$, 2-V step, $R_L = 1\text{ k}\Omega$, $C_L = 100\text{ pF}$ | To 10 mV | 0.25 | | | 0.25 | | | μ s |
| | | | To 1 mV | 0.4 | | | 0.4 | | | |
| V_n | Equivalent input noise voltage | $R_S = 20\ \Omega$, See Figure 3 | f = 10 Hz | 48 | 85 | | 48 | 85 | | nV/ $\sqrt{\text{Hz}}$ |
| | | | f = 10 kHz | 12 | 17 | | 12 | 17 | | |
| $V_{N(PP)}$ | Peak-to-peak equivalent input noise voltage | $R_S = 20\ \Omega$, See Figure 3 | f = 10 Hz to 10 kHz | 6 | | | 6 | | | μ V |
| | | | f = 0.1 Hz to 10 Hz | 0.6 | | | 0.6 | | | |
| I_n | Equivalent input noise current | $V_{IC} = 0$, f = 10 kHz | 25°C | 2.8 | | | 2.8 | | | fA/ $\sqrt{\text{Hz}}$ |
| THD + N | Total harmonic distortion plus noise | $V_{O(PP)} = 5\text{ V}$, f = 1 kHz, $R_S = 25\ \Omega$ | $A_{VD} = 10$, $R_L = 2\text{ k}\Omega$, 25°C | 0.013% | | | 0.013% | | | |
| B_1 | Unity-gain bandwidth | $V_I = 10\text{ mV}$, $C_L = 25\text{ pF}$, $R_L = 2\text{ k}\Omega$, See Figure 2 | 25°C | 9.4 | | | 9.4 | | | MHz |
| B_{OM} | Maximum output-swing bandwidth | $V_{O(PP)} = 4\text{ V}$, $R_L = 2\text{ k}\Omega$, $A_{VD} = -1$, $C_L = 25\text{ pF}$ | 25°C | 2.8 | | | 2.8 | | | MHz |
| ϕ_m | Phase margin at unity gain | $V_I = 10\text{ mV}$, $C_L = 25\text{ pF}$, $R_L = 2\text{ k}\Omega$, See Figure 2 | 25°C | 56° | | | 56° | | | |

† Full range is 40°C to 85°C.



TLE207x, TLE207xA EXCALIBUR LOW-NOISE HIGH-SPEED JFET-INPUT OPERATIONAL AMPLIFIERS

SLOS181C – FEBRUARY 1997 – REVISED DECEMBER 2009

TLE2072I electrical characteristics at specified free-air temperature, $V_{CC\pm} = \pm 15$ V (unless otherwise noted)

| PARAMETER | TEST CONDITIONS | T_A † | TLE2072I | | | TLE2072AI | | | UNIT | |
|-------------------------------------------------------------------------------|-------------------------------------------------------------------------|-----------------------|-------------|-------------|-----|-------------|-------------|------------------|----------|----|
| | | | MIN | TYP | MAX | MIN | TYP | MAX | | |
| V_{IO} Input offset voltage | $V_{IC} = 0,$ $R_S = 50 \Omega,$ $V_O = 0,$ | 25°C | 1.1 | 6 | | 0.7 | 3.5 | mV | | |
| | | Full range | | | 9.1 | | 6.4 | | | |
| α_{VIO} Temperature coefficient of input offset voltage | | Full range | 2.4 | 25 | | 2.4 | 25 | $\mu V/^\circ C$ | | |
| I_{IO} Input offset current | $V_{IC} = 0,$ $V_O = 0,$ See Figure 4 | 25°C | 6 | 100 | | 6 | 100 | pA | | |
| | | Full range | | | 5 | | 5 | nA | | |
| I_{IB} Input bias current | | 25°C | 20 | 175 | | 20 | 175 | pA | | |
| | | Full range | | | 10 | | 10 | nA | | |
| V_{ICR} Common-mode input voltage range | $R_S = 50 \Omega$ | 25°C | 15 to -11 | 15 to -11.9 | | 15 to -11 | 15 to -11.9 | V | | |
| | | Full range | 15 to -10.8 | | | 15 to -10.8 | | | | |
| V_{OM+} Maximum positive peak output voltage swing | $I_O = -200 \mu A$ | 25°C | 13.8 | 14.1 | | 13.8 | 14.1 | V | | |
| | | Full range | 13.7 | | | 13.7 | | | | |
| | $I_O = -2$ mA | 25°C | 13.5 | 13.9 | | 13.5 | 13.9 | | | |
| | | Full range | 13.4 | | | 13.4 | | | | |
| | $I_O = -20$ mA | 25°C | 11.5 | 12.3 | | 11.5 | 12.3 | | | |
| | | Full range | 11.5 | | | 11.5 | | | | |
| V_{OM-} Maximum negative peak output voltage swing | $I_O = 200 \mu A$ | 25°C | -13.8 | -14.2 | | -13.8 | -14.2 | V | | |
| | | Full range | -13.7 | | | -13.7 | | | | |
| | $I_O = 2$ mA | 25°C | -13.5 | -14 | | -13.5 | -14 | | | |
| | | Full range | -13.4 | | | -13.4 | | | | |
| | $I_O = 20$ mA | 25°C | -11.5 | -12.4 | | -11.5 | -12.4 | | | |
| | | Full range | -11.5 | | | -11.5 | | | | |
| A_{VD} Large-signal differential voltage amplification | $V_O = \pm 10$ V | $R_L = 600 \Omega$ | 25°C | 80 | 96 | | 80 | 96 | dB | |
| | | | Full range | 79 | | | 79 | | | |
| | | $R_L = 2$ k Ω | 25°C | 90 | 109 | | 90 | 109 | | |
| | | | Full range | 89 | | | 89 | | | |
| | | $R_L = 10$ k Ω | 25°C | 95 | 118 | | 95 | 118 | | |
| | | | Full range | 94 | | | 94 | | | |
| r_i Input resistance | $V_{IC} = 0$ | 25°C | 10^{12} | | | 10^{12} | | | Ω | |
| c_i Input capacitance | $V_{IC} = 0,$ See Figure 5 | Common mode | 25°C | 7.5 | | | 7.5 | | | pF |
| | | Differential | 25°C | 2.5 | | | 2.5 | | | |
| z_o Open-loop output impedance | $f = 1$ MHz | 25°C | 80 | | | 80 | | | Ω | |
| CMRR Common-mode rejection ratio | $V_{IC} = V_{ICRmin},$ $V_O = 0,$ $R_S = 50 \Omega$ | 25°C | 80 | 98 | | 80 | 98 | dB | | |
| | | Full range | 79 | | | 79 | | | | |
| k_{SVR} Supply-voltage rejection ratio ($\Delta V_{CC\pm}/\Delta V_{IO}$) | $V_{CC\pm} = \pm 5$ V to ± 15 V, $V_O = 0,$ $R_S = 50 \Omega$ | 25°C | 82 | 99 | | 82 | 99 | dB | | |
| | | Full range | 80 | | | 80 | | | | |

† Full range is $-40^\circ C$ to $85^\circ C$.



TLE207x, TLE207xA
EXCALIBUR LOW-NOISE HIGH-SPEED
JFET-INPUT OPERATIONAL AMPLIFIERS

SLOS181C – FEBRUARY 1997 – REVISED DECEMBER 2009

TLE2072I electrical characteristics at specified free-air temperature, $V_{CC\pm} = \pm 15\text{ V}$ (unless otherwise noted)
(continued)

| PARAMETER | TEST CONDITIONS | T_A | TLE2072I | | | TLE2072AI | | | UNIT | |
|-----------|--------------------------------|-----------------------------------------|------------|------------------------|-----|-----------|-----|-----|------|----|
| | | | MIN | TYP | MAX | MIN | TYP | MAX | | |
| I_{CC} | Supply current (both channels) | $V_O = 0$, No load | 25°C | 2.7 | 3.1 | 3.9 | 2.7 | 3.1 | 3.9 | mA |
| | | | Full range | 3.9 | | | 3.9 | | | |
| a_x | Crosstalk attenuation | $V_{IC} = 0$, $R_L = 2\text{ k}\Omega$ | 25°C | 120 | | | 120 | | | dB |
| I_{OS} | Short-circuit output current | $V_O = 0$ | 25°C | $V_{ID} = 1\text{ V}$ | -30 | -45 | -30 | -45 | mA | |
| | | | | $V_{ID} = -1\text{ V}$ | 30 | 48 | 30 | 48 | | |

TLE2072I operating characteristics at specified free-air temperature, $V_{CC\pm} = \pm 15\text{ V}$

| PARAMETER | TEST CONDITIONS | T_A^\dagger | TLE2072I | | | TLE2072AI | | | UNIT |
|-------------|---------------------------------------------|-----------------------------------------------------------------------------------------------------------------------------|------------|---------------------|-----|-----------|-----|------------------------|------------------------|
| | | | MIN | TYP | MAX | MIN | TYP | MAX | |
| SR+ | Positive slew rate | $V_{O(PP)} = \pm 10\text{ V}$, $A_{VD} = -1$, $C_L = 100\text{ pF}$, $R_L = 2\text{ k}\Omega$, See Figure 1 | 25°C | 28 | 40 | 28 | 40 | V/ μ s | |
| | | | Full range | 22 | | | 22 | | |
| SR- | Negative slew rate | | 25°C | 30 | 45 | 30 | 45 | V/ μ s | |
| | | | Full range | 22 | | | 22 | | |
| t_s | Settling time | $A_{VD} = -1$, 10-V step, $R_L = 1\text{ k}\Omega$, $C_L = 100\text{ pF}$ | 25°C | To 10 mV | 0.4 | | 0.4 | | μ s |
| | | | | To 1 mV | 1.5 | | 1.5 | | |
| V_n | Equivalent input noise voltage | | 25°C | f = 10 Hz | 48 | 85 | 48 | 85 | nV/ $\sqrt{\text{Hz}}$ |
| | | | | f = 10 kHz | 12 | 17 | 12 | 17 | |
| $V_{N(PP)}$ | Peak-to-peak equivalent input noise voltage | $R_S = 20\ \Omega$, See Figure 3 | 25°C | f = 0 Hz to 10 kHz | 6 | | 6 | | μ V |
| | | | | f = 0.1 Hz to 10 Hz | 0.6 | | 0.6 | | |
| I_n | Equivalent input noise current | $V_{IC} = 0$, f = 10 kHz | 25°C | 2.8 | | 2.8 | | fA/ $\sqrt{\text{Hz}}$ | |
| THD + N | Total harmonic distortion plus noise | $V_{O(PP)} = 20\text{ V}$, f = 1 kHz, $R_S = 25\ \Omega$ | 25°C | 0.008% | | 0.008% | | | |
| B_1 | Unity-gain bandwidth | $V_I = 10\text{ mV}$, $C_L = 25\text{ pF}$, $R_L = 2\text{ k}\Omega$, See Figure 2 | 25°C | 8 | 10 | 8 | 10 | MHz | |
| B_{OM} | Maximum output-swing bandwidth | $V_{O(PP)} = 20\text{ V}$, $R_L = 2\text{ k}\Omega$, $A_{VD} = -1$, $C_L = 25\text{ pF}$ | 25°C | 478 | 637 | 478 | 637 | kHz | |
| ϕ_m | Phase margin at unity gain | $V_I = 10\text{ mV}$, $C_L = 25\text{ pF}$, $R_L = 2\text{ k}\Omega$, See Figure 2 | 25°C | 57° | | 57° | | | |

† Full range is -40°C to 85°C.



TLE207x, TLE207xA EXCALIBUR LOW-NOISE HIGH-SPEED JFET-INPUT OPERATIONAL AMPLIFIERS

SLOS181C – FEBRUARY 1997 – REVISED DECEMBER 2009

TLE2072M electrical characteristics at specified free-air temperature, $V_{CC\pm} = \pm 5\text{ V}$ (unless otherwise noted)

| PARAMETER | TEST CONDITIONS | T_A † | TLE2072M | | | TLE2072AM | | | UNIT | |
|----------------------------------------------------------------|------------------------------------------------------------|----------------------------|------------|-----------|------|-----------|-----------|------------------------------|----------|----|
| | | | MIN | TYP | MAX | MIN | TYP | MAX | | |
| V_{IO} Input offset voltage | $V_{IC} = 0, V_O = 0,$ $R_S = 50\ \Omega,$ | 25°C | 0.9 | 6 | | 0.65 | 3.5 | mV | | |
| | | Full range | | | 10.5 | | 8 | | | |
| α_{VIO} Temperature coefficient of input offset voltage | | Full range | 2.3 | 25* | | 2.3 | 25* | $\mu\text{V}/^\circ\text{C}$ | | |
| I_{IO} Input offset current | $V_{IC} = 0, V_O = 0,$ See Figure 4 | 25°C | 5 | 100 | | 5 | 100 | pA | | |
| | | Full range | | | 20 | | 20 | nA | | |
| I_{IB} Input bias current | | 25°C | 15 | 175 | | 15 | 175 | pA | | |
| | | Full range | | | 60 | | 60 | nA | | |
| V_{ICR} Common-mode input voltage range | $R_S = 50\ \Omega$ | 25°C | 5 to -1 | 5 to -1.9 | | 5 to -1 | 5 to -1.9 | V | | |
| | | Full range | 5 to -0.8 | | | 5 to -0.8 | | | | |
| V_{OM+} Maximum positive peak output voltage swing | $I_O = -200\ \mu\text{A}$ | 25°C | 3.8 | 4.1 | | 3.8 | 4.1 | V | | |
| | | Full range | 3.6 | | | 3.6 | | | | |
| | $I_O = -2\ \text{mA}$ | 25°C | 3.5 | 3.9 | | 3.5 | 3.9 | | | |
| | | Full range | 3.3 | | | 3.3 | | | | |
| $I_O = -20\ \text{mA}$ | 25°C | 1.5 | 2.3 | | 1.5 | 2.3 | | | | |
| | Full range | 1.4 | | | 1.4 | | | | | |
| V_{OM-} Maximum negative peak output voltage swing | $I_O = 200\ \mu\text{A}$ | 25°C | -3.8 | -4.2 | | -3.8 | -4.2 | V | | |
| | | Full range | -3.6 | | | -3.6 | | | | |
| | $I_O = 2\ \text{mA}$ | 25°C | -3.5 | -4.1 | | -3.5 | -4.1 | | | |
| | | Full range | -3.3 | | | -3.3 | | | | |
| $I_O = 20\ \text{mA}$ | 25°C | -1.5 | -2.4 | | -1.5 | -2.4 | | | | |
| | Full range | -1.4 | | | -1.4 | | | | | |
| A_{VD} Large-signal differential voltage amplification | $V_O = \pm 2.3\ \text{V}$ | $R_L = 600\ \Omega$ | 25°C | 80 | 91 | | 80 | 91 | dB | |
| | | | Full range | 78 | | | 78 | | | |
| | | $R_L = 2\ \text{k}\Omega$ | 25°C | 90 | 100 | | 90 | 100 | | |
| | | | Full range | 88 | | | 88 | | | |
| | | $R_L = 10\ \text{k}\Omega$ | 25°C | 95 | 106 | | 95 | 106 | | |
| | | | Full range | 93 | | | 93 | | | |
| r_i Input resistance | $V_{IC} = 0$ | 25°C | 10^{12} | | | 10^{12} | | | Ω | |
| c_i Input capacitance | $V_{IC} = 0,$ See Figure 5 | Common mode | 25°C | 11 | | | 11 | | | pF |
| | | Differential | 25°C | 2.5 | | | 2.5 | | | |
| z_o Open-loop output impedance | $f = 1\ \text{MHz}$ | 25°C | 80 | | | 80 | | | Ω | |
| CMRR Common-mode rejection ratio | $V_{IC} = V_{ICRmin},$ $V_O = 0,$ $R_S = 50\ \Omega$ | 25°C | 70 | 89 | | 70 | 89 | dB | | |
| | | Full range | 68 | | | 68 | | | | |

*On products compliant to MIL-PRF-38535, Class B, this parameter is not production tested.

† Full range is -55°C to 125°C .



TLE207x, TLE207xA
EXCALIBUR LOW-NOISE HIGH-SPEED
JFET-INPUT OPERATIONAL AMPLIFIERS

SLOS181C – FEBRUARY 1997 – REVISED DECEMBER 2009

TLE2072M electrical characteristics at specified free-air temperature, $V_{CC\pm} = \pm 5\text{ V}$ (unless otherwise noted) (continued)

| PARAMETER | TEST CONDITIONS | T_A^\dagger | TLE2072M | | | TLE2072AM | | | UNIT |
|-----------|-----------------------------------------------------------------------|------------------------------------------------------------------------------------------|------------------------|-----|-----|-------------|-----|-----|------|
| | | | MIN | TYP | MAX | MIN | TYP | MAX | |
| k_{SVR} | Supply-voltage rejection ratio ($\Delta V_{CC\pm} / \Delta V_{IO}$) | $V_{CC\pm} = \pm 5\text{ V}$ to $\pm 15\text{ V}$, $V_O = 0$, $R_S = 50\ \Omega$ | Full range | | | 80 | | | dB |
| I_{CC} | Supply current (both channels) | $V_O = 0$, No load | 25°C | | | 2.7 2.9 3.6 | | | mA |
| | | | Full range | | | 3.6 | | | |
| a_x | Crosstalk attenuation | $V_{IC} = 0$, $R_L = 2\text{ k}\Omega$ | 25°C | | | 120 | | | dB |
| I_{OS} | Short-circuit output current | $V_O = 0$ | $V_{ID} = 1\text{ V}$ | | | -35 | | | mA |
| | | | $V_{ID} = -1\text{ V}$ | | | 45 | | | |

† Full range is -55°C to 125°C .

TLE2072M operating characteristics at specified free-air temperature, $V_{CC\pm} = \pm 5\text{ V}$

| PARAMETER | TEST CONDITIONS | T_A^\dagger | TLE2072M | | | TLE2072AM | | | UNIT |
|-------------|---------------------------------------------|------------------------------------------------------------------------------------------------------------------------------|---------------------|-----|-----|-----------|-----|-----|------------------------------|
| | | | MIN | TYP | MAX | MIN | TYP | MAX | |
| SR_+ | Positive slew rate | $V_{O(PP)} = \pm 2.3\text{ V}$, $A_{VD} = -1$, $C_L = 100\text{ pF}$, $R_L = 2\text{ k}\Omega$, See Figure 1 | 25°C | | | 35 | | | $\text{V}/\mu\text{s}$ |
| | | | Full range | | | 18* | | | |
| SR_- | Negative slew rate | $V_{O(PP)} = \pm 2.3\text{ V}$, $A_{VD} = -1$, $C_L = 100\text{ pF}$, $R_L = 2\text{ k}\Omega$, See Figure 1 | 25°C | | | 38 | | | $\text{V}/\mu\text{s}$ |
| | | | Full range | | | 18* | | | |
| t_s | Settling time | $A_{VD} = -1$, 2-V step, $R_L = 1\text{ k}\Omega$, $C_L = 100\text{ pF}$ | To 10 mV | | | 0.25 | | | μs |
| | | | To 1 mV | | | 0.4 | | | |
| V_n | Equivalent input noise voltage | $R_S = 20\ \Omega$, See Figure 3 | f = 10 Hz | | | 48 85* | | | $\text{nV}/\sqrt{\text{Hz}}$ |
| | | | f = 10 kHz | | | 12 17* | | | |
| $V_{N(PP)}$ | Peak-to-peak equivalent input noise voltage | $R_S = 20\ \Omega$, See Figure 3 | f = 10 Hz to 10 kHz | | | 6 | | | μV |
| | | | f = 0.1 Hz to 10 Hz | | | 0.6 | | | |
| I_n | Equivalent input noise current | $V_{IC} = 0$, f = 10 kHz | 25°C | | | 2.8 | | | $\text{fA}/\sqrt{\text{Hz}}$ |
| THD + N | Total harmonic distortion plus noise | $V_{O(PP)} = 5\text{ V}$, f = 1 kHz, $R_S = 25\ \Omega$ | 25°C | | | 0.013% | | | |
| B_1 | Unity-gain bandwidth | $V_I = 10\text{ mV}$, $C_L = 25\text{ pF}$, $R_L = 2\text{ k}\Omega$, See Figure 2 | 25°C | | | 9.4 | | | MHz |
| B_{OM} | Maximum output-swing bandwidth | $V_{O(PP)} = 4\text{ V}$, $R_L = 2\text{ k}\Omega$, $A_{VD} = -1$, $C_L = 25\text{ pF}$ | 25°C | | | 2.8 | | | MHz |
| ϕ_m | Phase margin at unity gain | $V_I = 10\text{ mV}$, $C_L = 25\text{ pF}$, $R_L = 2\text{ k}\Omega$, See Figure 2 | 25°C | | | 56° | | | |

*On products compliant to MIL-PRF-38535, Class B, this parameter is not production tested.

† Full range is -55°C to 125°C .



TLE207x, TLE207xA EXCALIBUR LOW-NOISE HIGH-SPEED JFET-INPUT OPERATIONAL AMPLIFIERS

SLOS181C – FEBRUARY 1997 – REVISED DECEMBER 2009

TLE2072M electrical characteristics at specified free-air temperature, $V_{CC\pm} = \pm 15$ V (unless otherwise noted)

| PARAMETER | TEST CONDITIONS | T_A † | TLE2072M | | | TLE2072AM | | | UNIT | |
|-------------------------------------------------------------------------------|------------------------------------------------------------------------------|----------------------------|-------------|-------------|-------|-------------|-------------|------------------|----------|----|
| | | | MIN | TYP | MAX | MIN | TYP | MAX | | |
| V_{IO} Input offset voltage | $V_{IC} = 0, V_O = 0, R_S = 50 \Omega$ | 25°C | 1.1 | 6 | | 0.7 | 3.5 | mV | | |
| | | Full range | | | 10.5 | | 8 | | | |
| α_{VIO} Temperature coefficient of input offset voltage | | Full range | 2.4 | 25* | | 2.4 | 25* | $\mu V/^\circ C$ | | |
| I_{IO} Input offset current | $V_{IC} = 0, V_O = 0, \text{See Figure 4}$ | 25°C | 6 | 100 | | 6 | 100 | pA | | |
| | | Full range | | | 20 | | 20 | nA | | |
| I_{IB} Input bias current | | 25°C | 20 | 175 | | 20 | 175 | pA | | |
| | | Full range | | | 60 | | 60 | nA | | |
| V_{ICR} Common-mode input voltage range | $R_S = 50 \Omega$ | 25°C | 15 to -11 | 15 to -11.9 | | 15 to -11 | 15 to -11.9 | V | | |
| | | Full range | 15 to -10.8 | | | 15 to -10.8 | | | | |
| V_{OM+} Maximum positive peak output voltage swing | $I_O = -200 \mu A$ | 25°C | 13.8 | 14.1 | | 13.8 | 14.1 | V | | |
| | | Full range | 13.6 | | | 13.6 | | | | |
| | $I_O = -2 \text{ mA}$ | 25°C | 13.5 | 13.9 | | 13.5 | 13.9 | | | |
| | | Full range | 13.3 | | | 13.3 | | | | |
| $I_O = -20 \text{ mA}$ | 25°C | 11.5 | 12.3 | | 11.5 | 12.3 | | | | |
| | Full range | 11.4 | | | 11.4 | | | | | |
| V_{OM-} Maximum negative peak output voltage swing | $I_O = 200 \mu A$ | 25°C | -13.8 | -14.2 | | -13.8 | -14.2 | V | | |
| | | Full range | -13.6 | | | -13.6 | | | | |
| | $I_O = 2 \text{ mA}$ | 25°C | -13.5 | -14 | | -13.5 | -14 | | | |
| | | Full range | -13.3 | | | -13.3 | | | | |
| $I_O = 20 \text{ mA}$ | 25°C | -11.5 | -12.4 | | -11.5 | -12.4 | | | | |
| | Full range | -11.4 | | | -11.4 | | | | | |
| A_{VD} Large-signal differential voltage amplification | $V_O = \pm 10 \text{ V}$ | $R_L = 600 \Omega$ | 25°C | 80 | 96 | | 80 | 96 | dB | |
| | | | Full range | 78 | | | 78 | | | |
| | | $R_L = 2 \text{ k}\Omega$ | 25°C | 90 | 109 | | 90 | 109 | | |
| | | | Full range | 89 | | | 89 | | | |
| | | $R_L = 10 \text{ k}\Omega$ | 25°C | 95 | 118 | | 95 | 118 | | |
| | | | Full range | 93 | | | 93 | | | |
| r_i Input resistance | $V_{IC} = 0$ | 25°C | 10^{12} | | | 10^{12} | | | Ω | |
| c_i Input capacitance | $V_{IC} = 0, \text{See Figure 5}$ | Common mode | 25°C | 7.5 | | | 7.5 | | | pF |
| | | Differential | 25°C | 2.5 | | | 2.5 | | | |
| z_o Open-loop output impedance | $f = 1 \text{ MHz}$ | 25°C | 80 | | | 80 | | | Ω | |
| CMRR Common-mode rejection ratio | $V_{IC} = V_{ICRmin}, V_O = 0, R_S = 50 \Omega$ | 25°C | 80 | 98 | | 80 | 98 | dB | | |
| | | Full range | 78 | | | 78 | | | | |
| k_{SVR} Supply-voltage rejection ratio ($\Delta V_{CC\pm}/\Delta V_{IO}$) | $V_{CC\pm} = \pm 5 \text{ V to } \pm 15 \text{ V}, V_O = 0, R_S = 50 \Omega$ | 25°C | 82 | 99 | | 82 | 99 | dB | | |
| | | Full range | 80 | | | 80 | | | | |

*On products compliant to MIL-PRF-38535, Class B, this parameter is not production tested.

† Full range is $-55^\circ C$ to $125^\circ C$.



TLE207x, TLE207xA
EXCALIBUR LOW-NOISE HIGH-SPEED
JFET-INPUT OPERATIONAL AMPLIFIERS

SLOS181C – FEBRUARY 1997 – REVISED DECEMBER 2009

TLE2072M electrical characteristics at specified free-air temperature, $V_{CC\pm} = \pm 15$ V (unless otherwise noted)

| PARAMETER | TEST CONDITIONS | T_A † | TLE2072M | | | TLE2072AM | | | UNIT | |
|-----------|--------------------------------|-------------------------------------|------------|-----------------|-----|-----------|-----|-----|------|----|
| | | | MIN | TYP | MAX | MIN | TYP | MAX | | |
| I_{CC} | Supply current (both channels) | $V_O = 0$, No load | 25°C | 2.7 | 3.1 | 3.6 | 2.7 | 3.1 | 3.6 | mA |
| | | | Full range | 3.6 | | | 3.6 | | | |
| a_x | Crosstalk attenuation | $V_{IC} = 0$, $R_L = 2$ k Ω | 25°C | 120 | | | 120 | | | dB |
| I_{OS} | Short-circuit output current | $V_O = 0$ | 25°C | $V_{ID} = 1$ V | -30 | -45 | -30 | -45 | mA | |
| | | | | $V_{ID} = -1$ V | 30 | 48 | 30 | 48 | | |

† Full range is -55°C to 125°C .

TLE2072M operating characteristics at specified free-air temperature, $V_{CC\pm} = \pm 15$ V

| PARAMETER | TEST CONDITIONS | T_A † | TLE2072M | | | TLE2072AM | | | UNIT | |
|-------------|---------------------------------------------|-------------------------------------------------------------------------|------------|---------------------|-----|-----------|--------|-----|------------------------|------------------------|
| | | | MIN | TYP | MAX | MIN | TYP | MAX | | |
| SR+ | Positive slew rate | $V_{O(PP)} = 10$ V, $R_L = 2$ k Ω , $C_L = 100$ pF, See Figure 1 | 25°C | 28 | 40 | | 28 | 40 | V/ μ s | |
| | | | Full range | 20 | | | 20 | | | |
| SR- | Negative slew rate | $V_{O(PP)} = 10$ V, $R_L = 2$ k Ω , $C_L = 100$ pF, See Figure 1 | 25°C | 30 | 45 | | 30 | 45 | V/ μ s | |
| | | | Full range | 20 | | | 20 | | | |
| t_s | Settling time | $A_{VD} = -1$, 10-V step, $R_L = 1$ k Ω , $C_L = 100$ pF | 25°C | To 10 mV | 0.4 | | 0.4 | | μ s | |
| | | | | To 1 mV | 1.5 | | 1.5 | | | |
| V_n | Equivalent input noise voltage | $R_S = 20$ Ω , See Figure 3 | 25°C | f = 10 Hz | 48 | 85* | 48 | 85* | nV/ $\sqrt{\text{Hz}}$ | |
| | | | | f = 10 kHz | 12 | 17* | 12 | 17* | | |
| $V_{N(PP)}$ | Peak-to-peak equivalent input noise voltage | $R_S = 20$ Ω , See Figure 3 | 25°C | f = 10 Hz to 10 kHz | 6 | | 6 | | μ V | |
| | | | | f = 0.1 Hz to 10 Hz | 0.6 | | 0.6 | | | |
| I_n | Equivalent input noise current | $V_{IC} = 0$, f = 10 kHz | 25°C | 2.8 | | | 2.8 | | | fA/ $\sqrt{\text{Hz}}$ |
| THD + N | Total harmonic distortion plus noise | $V_{O(PP)} = 20$ V, f = 1 kHz, $R_S = 25$ Ω | 25°C | 0.008% | | | 0.008% | | | |
| B_1 | Unity-gain bandwidth | $V_I = 10$ mV, $R_L = 2$ k Ω , $C_L = 25$ pF, See Figure 2 | 25°C | 8* | 10 | | 8* | 10 | MHz | |
| B_{OM} | Maximum output-swing bandwidth | $V_{O(PP)} = 20$ V, $R_L = 2$ k Ω , $C_L = 25$ pF | 25°C | 478* | 637 | | 478* | 637 | kHz | |
| ϕ_m | Phase margin at unity gain | $V_I = 10$ mV, $R_L = 2$ k Ω , $C_L = 25$ pF, See Figure 2 | 25°C | 57° | | | 57° | | | |

*On products compliant to MIL-PRF-38535, Class B, this parameter is not production tested.

† Full range is -55°C to 125°C .



TLE207x, TLE207xA
EXCALIBUR LOW-NOISE HIGH-SPEED
JFET-INPUT OPERATIONAL AMPLIFIERS

SLOS181C – FEBRUARY 1997 – REVISED DECEMBER 2009

TLE2072Y electrical characteristics at $V_{CC\pm} = \pm 15\text{ V}$, $T_A = 25^\circ\text{C}$

| PARAMETER | TEST CONDITIONS | TLE2072Y | | | UNIT |
|-------------------------------------------------------------------------------|-------------------------------------------------------------------------------------------|----------------------------|------------------|-----|----------|
| | | MIN | TYP | MAX | |
| V_{IO} Input offset voltage | $V_{IC} = 0$, $V_O = 0$, $R_S = 50\ \Omega$ | | 1.1 | 6 | mV |
| I_{IO} Input offset current | $V_{IC} = 0$, $V_O = 0$, See Figure 4 | | 6 | 100 | pA |
| I_{IB} Input bias current | | | 20 | 175 | pA |
| V_{ICR} Common-mode input voltage range | $R_S = 50\ \Omega$ | 15 to -11 | 15 to 11.9 | | V |
| V_{OM+} Maximum positive peak output voltage swing | $I_O = -200\ \mu\text{A}$ | 13.8 | 14.1 | | V |
| | $I_O = -2\ \text{mA}$ | 13.5 | 13.9 | | |
| | $I_O = -20\ \text{mA}$ | 11.5 | 12.3 | | |
| V_{OM-} Maximum negative peak output voltage swing | $I_O = 200\ \mu\text{A}$ | -13.8 | -14.2 | | V |
| | $I_O = 2\ \text{mA}$ | -13.5 | -14 | | |
| | $I_O = 20\ \text{mA}$ | -11.5 | -12.4 | | |
| A_{VD} Large-signal differential voltage amplification | $V_O = \pm 10\ \text{V}$ | $R_L = 600\ \Omega$ | 80 | 96 | dB |
| | | $R_L = 2\ \text{k}\Omega$ | 90 | 109 | |
| | | $R_L = 10\ \text{k}\Omega$ | 95 | 118 | |
| r_i Input resistance | $V_{IC} = 0$ | | 10^{12} | | Ω |
| c_i Input capacitance | $V_{IC} = 0$, See Figure 5 | Common mode | 7.5 | | pF |
| | | Differential | 2.5 | | |
| z_o Open-loop output impedance | $f = 1\ \text{MHz}$ | | 80 | | Ω |
| CMRR Common-mode rejection ratio | $V_{IC} = V_{ICRmin}$, $V_O = 0$, $R_S = 50\ \Omega$ | 80 | 98 | | dB |
| k_{SVR} Supply-voltage rejection ratio ($\Delta V_{CC\pm}/\Delta V_{IO}$) | $V_{CC\pm} = \pm 5\ \text{V}$ to $\pm 15\ \text{V}$, $R_S = 50\ \Omega$, $V_O = 0$, | 82 | 99 | | dB |
| I_{CC} Supply current (both channels) | $V_O = 0$, No load | 2.7 | 3.1 | 3.9 | mA |
| I_{OS} Short-circuit output current | $V_O = 0$ | $V_{ID} = 1\ \text{V}$ | -30 | -45 | mA |
| | | $V_{ID} = -1\ \text{V}$ | 30 | 48 | |



TLE207x, TLE207xA
EXCALIBUR LOW-NOISE HIGH-SPEED
JFET-INPUT OPERATIONAL AMPLIFIERS

SLOS181C – FEBRUARY 1997 – REVISED DECEMBER 2009

TLE2074C electrical characteristics at specified free-air temperature, $V_{CC\pm} = \pm 5\text{ V}$ (unless otherwise noted)

| PARAMETER | TEST CONDITIONS | T_A † | TLE2074C | | | TLE2074AC | | | UNIT | |
|---------------------------------------------------------------------------------|-------------------------------------------------------------------------------|-----------------------------------|------------|-----------|------|-----------|-----------|------------------------------|----------|----|
| | | | MIN | TYP | MAX | MIN | TYP | MAX | | |
| V_{IO} Input offset voltage | $V_{IC} = 0, V_O = 0, R_S = 50\ \Omega$ | 25°C | -1.6 | 5 | | -0.5 | 3 | mV | | |
| | | Full range | | | 7.1 | | 5.1 | | | |
| α_{VIO} Temperature coefficient of input offset voltage | | Full range | 10.1 | 30 | | 10.1 | 30 | $\mu\text{V}/^\circ\text{C}$ | | |
| I_{IO} Input offset current | $V_{IC} = 0, V_O = 0, \text{See Figure 4}$ | 25°C | 15 | 100 | | 15 | 100 | pA | | |
| | | Full range | | | 1400 | | 1400 | | | |
| I_{IB} Input bias current | | 25°C | 20 | 175 | | 20 | 175 | pA | | |
| | | Full range | | | 5000 | | 5000 | | | |
| V_{ICR} Common-mode input voltage range | $R_S = 50\ \Omega$ | 25°C | 5 to -1 | 5 to -1.9 | | 5 to -1 | 5 to -1.9 | V | | |
| | | Full range | 5 to -0.9 | | | 5 to -0.9 | | | | |
| V_{OM+} Maximum positive peak output voltage swing | $I_O = -200\ \mu\text{A}$ | 25°C | 3.8 | 4.1 | | 3.8 | 4.1 | V | | |
| | | Full range | 3.7 | | | 3.7 | | | | |
| | $I_O = -2\ \text{mA}$ | 25°C | 3.5 | 3.9 | | 3.5 | 3.9 | | | |
| | | Full range | 3.4 | | | 3.4 | | | | |
| | $I_O = -20\ \text{mA}$ | 25°C | 1.5 | 2.3 | | 1.5 | 2.3 | | | |
| | | Full range | 1.5 | | | 1.5 | | | | |
| V_{OM-} Maximum negative peak output voltage swing | $I_O = 200\ \mu\text{A}$ | 25°C | -3.8 | -4.2 | | -3.8 | -4.2 | V | | |
| | | Full range | -3.7 | | | -3.7 | | | | |
| | $I_O = 2\ \text{mA}$ | 25°C | -3.5 | -4.1 | | -3.5 | -4.1 | | | |
| | | Full range | -3.4 | | | -3.4 | | | | |
| | $I_O = 20\ \text{mA}$ | 25°C | -1.5 | -2.4 | | -1.5 | -2.4 | | | |
| | | Full range | -1.5 | | | -1.5 | | | | |
| A_{VD} Large-signal differential voltage amplification | $V_O = \pm 2.3\ \text{V}$ | $R_L = 600\ \Omega$ | 25°C | 80 | 91 | | 80 | 91 | dB | |
| | | | Full range | 79 | | | 79 | | | |
| | | $R_L = 2\ \text{k}\Omega$ | 25°C | 90 | 100 | | 90 | 100 | | |
| | | | Full range | 89 | | | 89 | | | |
| | | $R_L = 10\ \text{k}\Omega$ | 25°C | 95 | 106 | | 95 | 106 | | |
| | | | Full range | 94 | | | 94 | | | |
| r_i Input resistance | $V_{IC} = 0$ | 25°C | 10^{12} | | | 10^{12} | | | Ω | |
| c_i Input capacitance | Common mode | $V_{IC} = 0, \text{See Figure 5}$ | 25°C | 11 | | | 11 | | | pF |
| | Differential | | 25°C | 2.5 | | | 2.5 | | | |
| z_o Open-loop output impedance | $f = 1\ \text{MHz}$ | 25°C | 80 | | | 80 | | | Ω | |
| CMRR Common-mode rejection ratio | $V_{IC} = V_{ICRmin}, V_O = 0, R_S = 50\ \Omega$ | 25°C | 70 | 89 | | 70 | 89 | dB | | |
| | | Full range | 68 | | | 68 | | | | |
| k_{SVR} Supply-voltage rejection ratio ($\Delta V_{CC\pm} / \Delta V_{IO}$) | $V_{CC\pm} = \pm 5\ \text{V to } \pm 15\ \text{V}, V_O = 0, R_S = 50\ \Omega$ | 25°C | 82 | 99 | | 82 | 99 | dB | | |
| | | Full range | 80 | | | 80 | | | | |

† Full range is 0°C to 70°C.

TLE207x, TLE207xA EXCALIBUR LOW-NOISE HIGH-SPEED JFET-INPUT OPERATIONAL AMPLIFIERS

SLOS181C – FEBRUARY 1997 – REVISED DECEMBER 2009

TLE2074C electrical characteristics at specified free-air temperature, $V_{CC\pm} = \pm 5\text{ V}$ (unless otherwise noted) (continued)

| PARAMETER | TEST CONDITIONS | T_A † | TLE2074C | | | TLE2074AC | | | UNIT | |
|-----------|-------------------------------------|--------------------------------------------|------------|------------------------|-----|-----------|-----|-----|------|----|
| | | | MIN | TYP | MAX | MIN | TYP | MAX | | |
| I_{CC} | Supply current (four amplifiers) | $V_O = 0$, No load | 25°C | 5.2 | 6.3 | 7.5 | 5.2 | 6.3 | 7.5 | mA |
| | | | Full range | 7.5 | | | 7.5 | | | |
| | Crosstalk attenuation | $V_{IC} = 0$, $R_L = 2\text{ k}\Omega$ | 25°C | 120 | | | 120 | | | dB |
| I_{OS} | Short-circuit output current | $V_O = 0$ | 25°C | $V_{ID} = 1\text{ V}$ | | | -35 | | | mA |
| | | | | $V_{ID} = -1\text{ V}$ | | | 45 | | | |

† Full range is 0°C to 70°C.

TLE2074C operating characteristics at specified free-air temperature, $V_{CC\pm} = \pm 5\text{ V}$

| PARAMETER | TEST CONDITIONS | T_A † | TLE2074C | | | TLE2074AC | | | UNIT | |
|-------------|------------------------------------------------|------------------------------------------------------------------------------------------------------------------------------|------------|------------------------|-----|-----------|--------|-----|------|------------------------|
| | | | MIN | TYP | MAX | MIN | TYP | MAX | | |
| SR+ | Positive slew rate | $V_{O(PP)} = \pm 2.3\text{ V}$, $A_{VD} = -1$, $C_L = 100\text{ pF}$, $R_L = 2\text{ k}\Omega$, See Figure 1 | 25°C | 35 | | | 35 | | | V/ μ s |
| | | | Full range | 22 | | | 22 | | | |
| SR- | Negative slew rate | | 25°C | 38 | | | 38 | | | V/ μ s |
| | | | Full range | 22 | | | 22 | | | |
| t_s | Settling time | $A_{VD} = -1$, 2-V step, $R_L = 1\text{ k}\Omega$, $C_L = 100\text{ pF}$ | 25°C | To 10 mV | | | 0.25 | | | μ s |
| | | | | To 1 mV | | | 0.4 | | | |
| V_n | Equivalent input noise voltage | | 25°C | f = 10 Hz | | 48 | | 85 | | nV/ $\sqrt{\text{Hz}}$ |
| | | | | f = 10 kHz | | 12 | | 17 | | |
| $V_{N(PP)}$ | Peak-to-peak equivalent input noise voltage | $R_S = 20\ \Omega$, See Figure 3 | 25°C | f = 10 Hz to 10 kHz | | 6 | | 6 | | μ V |
| | | | | f = 0.1 Hz to 10 Hz | | 0.6 | | 0.6 | | |
| I_n | Equivalent input noise current | $V_{IC} = 0$, f = 10 kHz | 25°C | 2.8 | | | 2.8 | | | fA/ $\sqrt{\text{Hz}}$ |
| THD + N | Total harmonic distortion plus noise | $V_{O(PP)} = 5\text{ V}$, f = 1 kHz, $R_S = 25\ \Omega$ | 25°C | 0.013% | | | 0.013% | | | |
| B_1 | Unity-gain bandwidth | $V_I = 10\text{ mV}$, $C_L = 25\text{ pF}$, $R_L = 2\text{ k}\Omega$, See Figure 2 | 25°C | 9.4 | | | 9.4 | | | MHz |
| B_{OM} | Maximum output-swing bandwidth | $V_{O(PP)} = 4\text{ V}$, $R_L = 2\text{ k}\Omega$, $A_{VD} = -1$, $C_L = 25\text{ pF}$ | 25°C | 2.8 | | | 2.8 | | | MHz |
| ϕ_m | Phase margin at unity gain | $V_I = 10\text{ mV}$, $C_L = 25\text{ pF}$, $R_L = 2\text{ k}\Omega$, See Figure 2 | 25°C | 56° | | | 56° | | | |

† Full range is 0°C to 70°C.



TLE207x, TLE207xA
EXCALIBUR LOW-NOISE HIGH-SPEED
JFET-INPUT OPERATIONAL AMPLIFIERS

SLOS181C – FEBRUARY 1997 – REVISED DECEMBER 2009

TLE2074C electrical characteristics at specified free-air temperature, $V_{CC\pm} = \pm 15\text{ V}$ (unless otherwise noted)

| PARAMETER | TEST CONDITIONS | T_A^\dagger | TLE2074C | | | TLE2074AC | | | UNIT |
|-------------------------------------------------------------------------------|------------------------------------------------------------------------------------------|-------------------------------|-------------|-------------|------|-------------|-------------|----------|------------------------------|
| | | | MIN | TYP | MAX | MIN | TYP | MAX | |
| V_{IO} Input offset voltage | $V_{IC} = 0,$ $R_S = 50\ \Omega$ $V_O = 0,$ | 25°C | -1.6 | 5 | | -0.5 | 3 | | mV |
| | | Full range | | | 7.1 | | | 5.1 | |
| α_{VIO} Temperature coefficient of input offset voltage | | Full range | 10.1 | 30 | | 10.1 | 30 | | $\mu\text{V}/^\circ\text{C}$ |
| I_{IO} Input offset current | $V_{IC} = 0,$ $V_O = 0,$ See Figure 4 | 25°C | 15 | 100 | | 15 | 100 | | pA |
| | | Full range | | | 1400 | | | 1400 | |
| I_{IB} Input bias current | | 25°C | 25 | 175 | | 25 | 175 | | pA |
| | | Full range | | | 5000 | | | 5000 | |
| V_{ICR} Common-mode input voltage range | $R_S = 50\ \Omega$ | 25°C | 15 to -11 | 15 to -11.9 | | 15 to -11 | 15 to -11.9 | | V |
| | | Full range | 15 to -10.9 | | | 15 to -10.9 | | | |
| V_{OM+} Maximum positive peak output voltage swing | $I_O = -200\ \mu\text{A}$ | 25°C | 13.8 | 14.1 | | 13.8 | 14.1 | | V |
| | | Full range | 13.7 | | | 13.7 | | | |
| | $I_O = -2\ \text{mA}$ | 25°C | 13.5 | 13.9 | | 13.5 | 13.9 | | |
| | | Full range | 13.4 | | | 13.4 | | | |
| | $I_O = -20\ \text{mA}$ | 25°C | 11.5 | 12.3 | | 11.5 | 12.3 | | |
| | | Full range | 11.5 | | | 11.5 | | | |
| V_{OM-} Maximum negative peak output voltage swing | $I_O = 200\ \mu\text{A}$ | 25°C | -13.8 | -14.2 | | -13.8 | -14.2 | | V |
| | | Full range | -13.7 | | | -13.7 | | | |
| | $I_O = 2\ \text{mA}$ | 25°C | -13.7 | -14 | | -13.7 | -14 | | |
| | | Full range | -13.6 | | | -13.6 | | | |
| | $I_O = 20\ \text{mA}$ | 25°C | -11.5 | -12.4 | | -11.5 | -12.4 | | |
| | | Full range | -11.5 | | | -11.5 | | | |
| A_{VD} Large-signal differential voltage amplification | $V_O = \pm 10\ \text{V}$ | $R_L = 600\ \Omega$ | 25°C | 80 | 96 | | 80 | 96 | dB |
| | | | Full range | 79 | | | 79 | | |
| | | $R_L = 2\ \text{k}\Omega$ | 25°C | 90 | 109 | | 90 | 109 | |
| | | | Full range | 89 | | | 89 | | |
| | | $R_L = 10\ \text{k}\Omega$ | 25°C | 95 | 118 | | 95 | 118 | |
| | | | Full range | 94 | | | 94 | | |
| r_i Input resistance | $V_{IC} = 0$ | 25°C | | 10^{12} | | 10^{12} | | Ω | |
| c_i Input capacitance | Common mode | $V_{IC} = 0,$ See Figure 5 | 25°C | | 7.5 | | 7.5 | pF | |
| | Differential | | 25°C | | 2.5 | | 2.5 | | |
| z_o Open-loop output impedance | $f = 1\ \text{MHz}$ | 25°C | | 80 | | 80 | | Ω | |
| CMRR Common-mode rejection ratio | $V_{IC} = V_{ICRmin},$ $V_O = 0,$ $R_S = 50\ \Omega$ | 25°C | 80 | 98 | | 80 | 98 | dB | |
| | | Full range | 79 | | | 79 | | | |
| k_{SVR} Supply-voltage rejection ratio ($\Delta V_{CC\pm}/\Delta V_{IO}$) | $V_{CC\pm} = \pm 5\ \text{V}$ to $\pm 15\ \text{V},$ $V_O = 0,$ $R_S = 50\ \Omega$ | 25°C | 82 | 99 | | 82 | 99 | dB | |
| | | Full range | 81 | | | 81 | | | |

† Full range is 0°C to 70°C.

TLE207x, TLE207xA
EXCALIBUR LOW-NOISE HIGH-SPEED
JFET-INPUT OPERATIONAL AMPLIFIERS

SLOS181C – FEBRUARY 1997 – REVISED DECEMBER 2009

TLE2074C electrical characteristics at specified free-air temperature, $V_{CC\pm} = \pm 15\text{ V}$ (unless otherwise noted) (continued)

| PARAMETER | TEST CONDITIONS | T_A^\dagger | TLE2074C | | | TLE2074AC | | | UNIT |
|-------------------------------------------|-----------------------------------------|------------------------|----------|-----|-----|-----------|-----|-----|------|
| | | | MIN | TYP | MAX | MIN | TYP | MAX | |
| I_{CC} Supply current (four amplifiers) | $V_O = 0$, No load | 25°C | 5.2 | 6.5 | 7.5 | 5.2 | 6.5 | 7.5 | mA |
| | | Full range | 7.5 | | | 7.5 | | | |
| Crosstalk attenuation | $V_{IC} = 0$, $R_L = 2\text{ k}\Omega$ | 25°C | 120 | | | 120 | | | dB |
| I_{OS} Short-circuit output current | $V_O = 0$ | $V_{ID} = 1\text{ V}$ | -30 | -45 | | -30 | -45 | | mA |
| | | $V_{ID} = -1\text{ V}$ | 30 | 48 | | 30 | 48 | | |

† Full range is 0°C to 70°C.

TLE2074C operating characteristics at specified free-air temperature, $V_{CC\pm} = \pm 15\text{ V}$

| PARAMETER | TEST CONDITIONS | T_A^\dagger | TLE2074C | | | TLE2074AC | | | UNIT | |
|---------------------------------------------------------|-------------------------------------------------------------------------------------------------------------------|---------------------------------------------|----------|--------|-----|-----------|--------|-----|------------------------|-----|
| | | | MIN | TYP | MAX | MIN | TYP | MAX | | |
| SR+ Positive slew rate | $V_{O(PP)} = 10\text{ V}$, $A_{VD} = -1$, $R_L = 2\text{ k}\Omega$, $C_L = 100\text{ pF}$, See Figure 1 | 25°C | 25 | 40 | | 25 | 40 | | V/ μ s | |
| | | Full range | 22 | | | 22 | | | | |
| SR- Negative slew rate | | 25°C | 30 | 45 | | 30 | 45 | | V/ μ s | |
| | | Full range | 25 | | | 25 | | | | |
| t_s Settling time | $A_{VD} = -1$, 10-V step, $R_L = 1\text{ k}\Omega$, $C_L = 100\text{ pF}$ | To 10 mV | 0.4 | | | 0.4 | | | μ s | |
| | | To 1 mV | 1.5 | | | 1.5 | | | | |
| V_n Equivalent input noise voltage | $R_S = 20\ \Omega$, See Figure 3 | f = 10 Hz | 48 | 85 | | 48 | 85 | | nV/ $\sqrt{\text{Hz}}$ | |
| | | f = 10 kHz | 12 | 17 | | 12 | 17 | | | |
| $V_{N(PP)}$ Peak-to-peak equivalent input noise voltage | | f = 10 Hz to 10 kHz | 6 | | | 6 | | | μ V | |
| | | f = 0.1 Hz to 10 Hz | 0.6 | | | 0.6 | | | | |
| I_n Equivalent input noise current | $V_{IC} = 0$, f = 10 kHz | 25°C | 2.8 | | | 2.8 | | | fA/ $\sqrt{\text{Hz}}$ | |
| THD + N Total harmonic distortion plus noise | $V_{O(PP)} = 20\text{ V}$, f = 1 kHz, $R_S = 25\ \Omega$ | $A_{VD} = 10$, $R_L = 2\text{ k}\Omega$ | 25°C | 0.008% | | | 0.008% | | | |
| B_1 Unity-gain bandwidth | $V_I = 10\text{ mV}$, $C_L = 25\text{ pF}$, $R_L = 2\text{ k}\Omega$, See Figure 2 | 25°C | 8 | 10 | | 8 | 10 | | MHz | |
| B_{OM} Maximum output-swing bandwidth | $V_{O(PP)} = 20\text{ V}$, $R_L = 2\text{ k}\Omega$, $C_L = 25\text{ pF}$ | $A_{VD} = -1$ | 25°C | 478 | 637 | | 478 | 637 | | kHz |
| ϕ_m Phase margin at unity gain | $V_I = 10\text{ mV}$, $C_L = 25\text{ pF}$, See Figure 2 | $R_L = 2\text{ k}\Omega$ | 25°C | 57° | | | 57° | | | |

† Full range is 0°C to 70°C.



TLE207x, TLE207xA
EXCALIBUR LOW-NOISE HIGH-SPEED
JFET-INPUT OPERATIONAL AMPLIFIERS

SLOS181C – FEBRUARY 1997 – REVISED DECEMBER 2009

TLE2074I electrical characteristics at specified free-air temperature, $V_{CC\pm} = \pm 5\text{ V}$ (unless otherwise noted)

| PARAMETER | TEST CONDITIONS | T_A^\dagger | TLE2074I | | | TLE2074AI | | | UNIT | |
|-------------------------------------------------------------------------------|-------------------------------------------------------------------------------|-----------------------------------|------------|-----------|------|-----------|-----------|------------------------------|----------|----|
| | | | MIN | TYP | MAX | MIN | TYP | MAX | | |
| V_{IO} Input offset voltage | $V_{IC} = 0, V_O = 0, R_S = 50\ \Omega$ | 25°C | -1.6 | 5 | | -0.5 | 3 | mV | | |
| | | Full range | | | 9 | | 7 | | | |
| α_{VIO} Temperature coefficient of input offset voltage | | Full range | 10.1 | 30 | | 10.1 | 30 | $\mu\text{V}/^\circ\text{C}$ | | |
| I_{IO} Input offset current | $V_{IC} = 0, V_O = 0, \text{See Figure 4}$ | 25°C | 15 | 100 | | 15 | 100 | pA | | |
| | | Full range | | 5 | | | 5 | nA | | |
| I_{IB} Input bias current | | 25°C | 20 | 175 | | 20 | 175 | pA | | |
| | | Full range | | 10 | | | 10 | nA | | |
| V_{ICR} Common-mode input voltage range | $R_S = 50\ \Omega$ | 25°C | 5 to -1 | 5 to -1.9 | | 5 to -1 | 5 to -1.9 | V | | |
| | | Full range | 5 to -0.8 | | | 5 to -0.8 | | | | |
| V_{OM+} Maximum positive peak output voltage swing | $I_O = -200\ \mu\text{A}$ | 25°C | 3.8 | 4.1 | | 3.8 | 4.1 | V | | |
| | | Full range | 3.7 | | | 3.7 | | | | |
| | $I_O = -2\ \text{mA}$ | 25°C | 3.5 | 3.9 | | 3.5 | 3.9 | | | |
| | | Full range | 3.4 | | | 3.4 | | | | |
| $I_O = -20\ \text{mA}$ | 25°C | 1.5 | 2.3 | | 1.5 | 2.3 | | | | |
| | Full range | 1.5 | | | 1.5 | | | | | |
| V_{OM-} Maximum negative peak output voltage swing | $I_O = 200\ \mu\text{A}$ | 25°C | -3.8 | -4.2 | | -3.8 | -4.2 | V | | |
| | | Full range | -3.7 | | | -3.7 | | | | |
| | $I_O = 2\ \text{mA}$ | 25°C | -3.5 | -4.1 | | -3.5 | -4.1 | | | |
| | | Full range | -3.4 | | | -3.4 | | | | |
| $I_O = 20\ \text{mA}$ | 25°C | -1.5 | -2.4 | | -1.5 | -2.4 | | | | |
| | Full range | -1.5 | | | -1.5 | | | | | |
| A_{VD} Large-signal differential voltage amplification | $V_O = \pm 2.3\ \text{V}$ | $R_L = 600\ \Omega$ | 25°C | 80 | 91 | | 80 | 91 | dB | |
| | | | Full range | 79 | | | 79 | | | |
| | | $R_L = 2\ \text{k}\Omega$ | 25°C | 90 | 100 | | 90 | 100 | | |
| | | | Full range | 89 | | | 89 | | | |
| | | $R_L = 10\ \text{k}\Omega$ | 25°C | 95 | 106 | | 95 | 106 | | |
| | | | Full range | 94 | | | 94 | | | |
| r_i Input resistance | $V_{IC} = 0$ | 25°C | 10^{12} | | | 10^{12} | | | Ω | |
| c_i Input capacitance | Common mode | $V_{IC} = 0, \text{See Figure 5}$ | 25°C | 11 | | | 11 | | | pF |
| | Differential | | 25°C | 2.5 | | | 2.5 | | | |
| z_o Open-loop output impedance | $f = 1\ \text{MHz}$ | 25°C | 80 | | | 80 | | | Ω | |
| CMRR Common-mode rejection ratio | $V_{IC} = V_{ICR\text{min}}, V_O = 0, R_S = 50\ \Omega$ | 25°C | 70 | 89 | | 70 | 89 | dB | | |
| | | Full range | 68 | | | 68 | | | | |
| k_{SVR} Supply-voltage rejection ratio ($\Delta V_{CC\pm}/\Delta V_{IO}$) | $V_{CC\pm} = \pm 5\ \text{V to } \pm 15\ \text{V}, V_O = 0, R_S = 50\ \Omega$ | 25°C | 82 | 99 | | 82 | 99 | dB | | |
| | | Full range | 80 | | | 80 | | | | |

† Full range is -40°C to 85°C .



TLE207x, TLE207xA
EXCALIBUR LOW-NOISE HIGH-SPEED
JFET-INPUT OPERATIONAL AMPLIFIERS

SLOS181C – FEBRUARY 1997 – REVISED DECEMBER 2009

TLE2074I electrical characteristics at specified free-air temperature, $V_{CC\pm} = \pm 5\text{ V}$ (unless otherwise noted) (continued)

| PARAMETER | TEST CONDITIONS | T_A^\dagger | TLE2074I | | | TLE2074AI | | | UNIT |
|-------------------------------------------|-----------------------------------------|------------------------|----------|-----|-----|-----------|-----|-----|------|
| | | | MIN | TYP | MAX | MIN | TYP | MAX | |
| I_{CC} Supply current (four amplifiers) | $V_O = 0$, No load | 25°C | 5.2 | 6.3 | 7.5 | 5.2 | 6.3 | 7.5 | mA |
| | | Full range | 7.5 | | | 7.5 | | | |
| Crosstalk attenuation | $V_{IC} = 0$, $R_L = 2\text{ k}\Omega$ | 25°C | 120 | | | 120 | | | dB |
| I_{OS} Short-circuit output current | $V_O = 0$ | $V_{ID} = 1\text{ V}$ | -35 | | | -35 | | | mA |
| | | $V_{ID} = -1\text{ V}$ | 45 | | | 45 | | | |

† Full range is -40°C to 85°C .

TLE2074I operating characteristics at specified free-air temperature, $V_{CC\pm} = \pm 5\text{ V}$

| PARAMETER | TEST CONDITIONS | T_A^\dagger | TLE2074I | | | TLE2074AI | | | UNIT | |
|---------------------------------------------------------|------------------------------------------------------------------------------------------------------------------------------|---------------------------------------------|----------|--------|-----|-----------|--------|------------------------|------------------------|-----|
| | | | MIN | TYP | MAX | MIN | TYP | MAX | | |
| SR+ Positive slew rate | $V_{O(PP)} = \pm 2.3\text{ V}$, $A_{VD} = -1$, $C_L = 100\text{ pF}$, $R_L = 2\text{ k}\Omega$, See Figure 1 | 25°C | 35 | | | 35 | | | V/ μs | |
| | | Full range | 20 | | | 20 | | | | |
| SR- Negative slew rate | | 25°C | 38 | | | 38 | | | V/ μs | |
| | | Full range | 20 | | | 20 | | | | |
| t_s Settling time | $A_{VD} = -1$, 2-V step, $R_L = 1\text{ k}\Omega$, $C_L = 100\text{ pF}$ | To 10 mV | 0.25 | | | 0.25 | | | μs | |
| | | To 1 mV | 0.4 | | | 0.4 | | | | |
| V_n Equivalent input noise voltage | $R_S = 20\ \Omega$, See Figure 3 | f = 10 Hz | 48 | 85 | | 48 | 85 | nV/ $\sqrt{\text{Hz}}$ | | |
| | | f = 10 kHz | 12 | 17 | | 12 | 17 | | | |
| $V_{N(PP)}$ Peak-to-peak equivalent input noise voltage | | f = 10 Hz to 10 kHz | 6 | | | 6 | | | μV | |
| | | f = 0.1 Hz to 10 Hz | 0.6 | | | 0.6 | | | | |
| I_n Equivalent input noise current | $V_{IC} = 0$, f = 10 kHz | 25°C | 2.8 | | | 2.8 | | | fA/ $\sqrt{\text{Hz}}$ | |
| THD + N Total harmonic distortion plus noise | $V_{O(PP)} = 5\text{ V}$, f = 1 kHz, $R_S = 25\ \Omega$ | $A_{VD} = 10$, $R_L = 2\text{ k}\Omega$ | 25°C | 0.013% | | | 0.013% | | | |
| B_1 Unity-gain bandwidth | $V_I = 10\text{ mV}$, $C_L = 25\text{ pF}$ | $R_L = 2\text{ k}\Omega$, See Figure 2 | 25°C | 9.4 | | | 9.4 | | | MHz |
| B_{OM} Maximum output-swing bandwidth | $V_{O(PP)} = 4\text{ V}$, $R_L = 2\text{ k}\Omega$ | $A_{VD} = -1$, $C_L = 25\text{ pF}$ | 25°C | 2.8 | | | 2.8 | | | MHz |
| ϕ_m Phase margin at unity gain | $V_I = 10\text{ mV}$, $C_L = 25\text{ pF}$ | $R_L = 2\text{ k}\Omega$, See Figure 2 | 25°C | 56° | | | 56° | | | |

† Full range is -40°C to 85°C .



TLE207x, TLE207xA
EXCALIBUR LOW-NOISE HIGH-SPEED
JFET-INPUT OPERATIONAL AMPLIFIERS

SLOS181C – FEBRUARY 1997 – REVISED DECEMBER 2009

TLE2074I electrical characteristics at specified free-air temperature, $V_{CC\pm} = \pm 15\text{ V}$ (unless otherwise noted)

| PARAMETER | TEST CONDITIONS | T_A^\dagger | TLE2074I | | | TLE2074AI | | | UNIT | |
|-------------------------------------------------------------------------------|-------------------------------------------------------------------------------|-----------------------------------|-------------|-------------|-----|-------------|-------------|------------------------------|----------|----|
| | | | MIN | TYP | MAX | MIN | TYP | MAX | | |
| V_{IO} Input offset voltage | $V_{IC} = 0, V_O = 0, R_S = 50\ \Omega$ | 25°C | -1.6 | 5 | | -0.5 | 3 | mV | | |
| | | Full range | | | 9 | | 7 | | | |
| α_{VIO} Temperature coefficient of input offset voltage | | Full range | 10.1 | 30 | | 10.1 | 30 | $\mu\text{V}/^\circ\text{C}$ | | |
| I_{IO} Input offset current | $V_{IC} = 0, V_O = 0, \text{See Figure 4}$ | 25°C | 15 | 100 | | 15 | 100 | pA | | |
| | | Full range | | 5 | | | 5 | nA | | |
| I_{IB} Input bias current | | 25°C | 25 | 175 | | 25 | 175 | pA | | |
| | | Full range | | 10 | | | 10 | nA | | |
| V_{ICR} Common-mode input voltage range | $R_S = 50\ \Omega$ | 25°C | 15 to -11 | 15 to -11.9 | | 15 to -11 | 15 to -11.9 | V | | |
| | | Full range | 15 to -10.8 | | | 15 to -10.8 | | | | |
| V_{OM+} Maximum positive peak output voltage swing | $I_O = -200\ \mu\text{A}$ | 25°C | 13.8 | 14.1 | | 13.8 | 14.1 | V | | |
| | | Full range | 13.7 | | | 13.7 | | | | |
| | $I_O = -2\ \text{mA}$ | 25°C | 13.5 | 13.9 | | 13.5 | 13.9 | | | |
| | | Full range | 13.4 | | | 13.4 | | | | |
| | $I_O = -20\ \text{mA}$ | 25°C | 11.5 | 12.3 | | 11.5 | 12.3 | | | |
| | | Full range | 11.5 | | | 11.5 | | | | |
| V_{OM-} Maximum negative peak output voltage swing | $I_O = 200\ \mu\text{A}$ | 25°C | -13.8 | -14.2 | | -13.8 | -14.2 | V | | |
| | | Full range | -13.7 | | | -13.7 | | | | |
| | $I_O = 2\ \text{mA}$ | 25°C | -13.5 | -14 | | -13.5 | -14 | | | |
| | | Full range | -13.4 | | | -13.4 | | | | |
| | $I_O = 20\ \text{mA}$ | 25°C | -11.5 | -12.4 | | -11.5 | -12.4 | | | |
| | | Full range | -11.5 | | | -11.5 | | | | |
| A_{VD} Large-signal differential voltage amplification | $V_O = \pm 10\ \text{V}$ | $R_L = 600\ \Omega$ | 25°C | 80 | 96 | | 80 | 96 | dB | |
| | | | Full range | 79 | | | 79 | | | |
| | | $R_L = 2\ \text{k}\Omega$ | 25°C | 90 | 109 | | 90 | 109 | | |
| | | | Full range | 89 | | | 89 | | | |
| | | $R_L = 10\ \text{k}\Omega$ | 25°C | 95 | 118 | | 95 | 118 | | |
| | | | Full range | 94 | | | 94 | | | |
| r_i Input resistance | $V_{IC} = 0$ | 25°C | 10^{12} | | | 10^{12} | | | Ω | |
| c_i Input capacitance | Common mode | $V_{IC} = 0, \text{See Figure 5}$ | 25°C | 7.5 | | | 7.5 | | | pF |
| | Differential | | 25°C | 2.5 | | | 2.5 | | | |
| z_o Open-loop output impedance | $f = 1\ \text{MHz}$ | 25°C | 80 | | | 80 | | | Ω | |
| CMRR Common-mode rejection ratio | $V_{IC} = V_{ICRmin}, V_O = 0, R_S = 50\ \Omega$ | 25°C | 80 | 98 | | 80 | 98 | dB | | |
| | | Full range | 79 | | | 79 | | | | |
| k_{SVR} Supply-voltage rejection ratio ($\Delta V_{CC\pm}/\Delta V_{IO}$) | $V_{CC\pm} = \pm 5\ \text{V to } \pm 15\ \text{V}, V_O = 0, R_S = 50\ \Omega$ | 25°C | 82 | 99 | | 82 | 99 | dB | | |
| | | Full range | 80 | | | 80 | | | | |

† Full range is -40°C to 85°C .



TLE207x, TLE207xA
EXCALIBUR LOW-NOISE HIGH-SPEED
JFET-INPUT OPERATIONAL AMPLIFIERS

SLOS181C – FEBRUARY 1997 – REVISED DECEMBER 2009

TLE2074I electrical characteristics at specified free-air temperature, $V_{CC\pm} = \pm 15$ V (unless otherwise noted) (continued)

| PARAMETER | TEST CONDITIONS | T_A † | TLE2074I | | | TLE2074AI | | | UNIT | |
|-----------|----------------------------------|-------------------------------------|------------|-----------------|-----|-----------|-----|-----|------|----|
| | | | MIN | TYP | MAX | MIN | TYP | MAX | | |
| I_{CC} | Supply current (four amplifiers) | $V_O = 0$, No load | 25°C | 5.2 | 6.5 | 7.5 | 5.2 | 6.5 | 7.5 | mA |
| | | | Full range | 7.5 | | | 7.5 | | | |
| | Crosstalk attenuation | $V_{IC} = 0$, $R_L = 2$ k Ω | 25°C | 120 | | | 120 | | | dB |
| I_{OS} | Short-circuit output current | $V_O = 0$ | 25°C | $V_{ID} = 1$ V | -30 | -45 | -30 | -45 | mA | |
| | | | | $V_{ID} = -1$ V | 30 | 48 | 30 | 48 | | |

† Full range is -40°C to 85°C.

TLE2074I operating characteristics at specified free-air temperature, $V_{CC\pm} = \pm 15$ V

| PARAMETER | TEST CONDITIONS | T_A † | TLE2074I | | | TLE2074AI | | | UNIT |
|-------------|---------------------------------------------|---------------------------------------------------------------------------------------------------------|------------|---------------------|-----|-----------|-----|-----------------|-----------------|
| | | | MIN | TYP | MAX | MIN | TYP | MAX | |
| SR+ | Positive slew rate | $V_{O(PP)} = \pm 10$ V, $A_{VD} = -1$, $C_L = 100$ pF, $R_L = 2$ k Ω , See Figure 1 | 25°C | 25 | 40 | 25 | 40 | V/ μ s | |
| | | | Full range | 19 | | | 19 | | |
| SR- | Negative slew rate | $V_{O(PP)} = \pm 10$ V, $A_{VD} = -1$, $C_L = 100$ pF, $R_L = 2$ k Ω , See Figure 1 | 25°C | 30 | 45 | 30 | 45 | V/ μ s | |
| | | | Full range | 22 | | | 22 | | |
| t_s | Settling time | $A_{VD} = -1$, 10-V step, $R_L = 1$ k Ω , $C_L = 100$ pF | 25°C | To 10 mV | 0.4 | | 0.4 | | μ s |
| | | | | To 1 mV | 1.5 | | 1.5 | | |
| V_n | Equivalent input noise voltage | $R_S = 20$ Ω , See Figure 3 | 25°C | f = 10 Hz | 48 | 85 | 48 | 85 | nV/ \sqrt{Hz} |
| | | | | f = 10 kHz | 12 | 17 | 12 | 17 | |
| $V_{N(PP)}$ | Peak-to-peak equivalent input noise voltage | $R_S = 20$ Ω , See Figure 3 | 25°C | f = 10 Hz to 10 kHz | 6 | | 6 | | μ V |
| | | | | f = 0.1 Hz to 10 Hz | 0.6 | | 0.6 | | |
| I_n | Equivalent input noise current | $V_{IC} = 0$, f = 10 kHz | 25°C | 2.8 | | 2.8 | | fA/ \sqrt{Hz} | |
| THD + N | Total harmonic distortion plus noise | $V_{O(PP)} = 20$ V, f = 1 kHz, $R_S = 25$ Ω | 25°C | 0.008% | | 0.008% | | | |
| B_1 | Unity-gain bandwidth | $V_I = 10$ mV, $C_L = 25$ pF, $R_L = 2$ k Ω , See Figure 2 | 25°C | 8 | 10 | 8 | 10 | MHz | |
| B_{OM} | Maximum output-swing bandwidth | $V_{O(PP)} = 20$ V, $R_L = 2$ k Ω , $A_{VD} = -1$, $C_L = 25$ pF | 25°C | 478 | 637 | 478 | 637 | kHz | |
| ϕ_m | Phase margin at unity gain | $V_I = 10$ mV, $C_L = 25$ pF, $R_L = 2$ k Ω , See Figure 2 | 25°C | 57° | | 57° | | | |

† Full range is -40°C to 85°C.



TLE207x, TLE207xA
EXCALIBUR LOW-NOISE HIGH-SPEED
JFET-INPUT OPERATIONAL AMPLIFIERS

SLOS181C – FEBRUARY 1997 – REVISED DECEMBER 2009

TLE2074M electrical characteristics at specified free-air temperature, $V_{CC\pm} = \pm 5\text{ V}$ (unless otherwise noted)

| PARAMETER | TEST CONDITIONS | T_A^\dagger | TLE2074M | | | TLE2074AM | | | UNIT | |
|---------------------------------------------------------------------------------|---------------------------------------------------------------------------|-----------------------------------|------------|-----------------|------|-----------|-----------------|------------------------------|----------|----|
| | | | MIN | TYP | MAX | MIN | TYP | MAX | | |
| V_{IO} Input offset voltage | $V_{IC} = 0, V_O = 0, R_S = 50\Omega$ | 25°C | -1.6 | 5 | | -0.5 | 3 | mV | | |
| | | Full range | | | 10.5 | | 8.5 | | | |
| α_{VIO} Temperature coefficient of input offset voltage | | Full range | 10.1 | 30 [‡] | | 10.1 | 30 [‡] | $\mu\text{V}/^\circ\text{C}$ | | |
| I_{IO} Input offset current | $V_{IC} = 0, V_O = 0, \text{See Figure 4}$ | 25°C | 15 | 100 | | 15 | 100 | pA | | |
| | | Full range | | | 20 | | 20 | nA | | |
| I_{IB} Input bias current | | 25°C | 20 | 175 | | 20 | 175 | pA | | |
| | | Full range | | | 60 | | 60 | nA | | |
| V_{ICR} Common-mode input voltage range | $R_S = 50\Omega$ | 25°C | 5 to -1 | 5 to -1.9 | | 5 to -1 | 5 to -1.9 | V | | |
| | | Full range | 5 to -0.8 | | | 5 to -0.8 | | | | |
| V_{OM+} Maximum positive peak output voltage swing | $I_O = -200\mu\text{A}$ | 25°C | 3.8 | 4.1 | | 3.8 | 4.1 | V | | |
| | | Full range | 3.6 | | | 3.6 | | | | |
| | $I_O = -2\text{ mA}$ | 25°C | 3.5 | 3.9 | | 3.5 | 3.9 | | | |
| | | Full range | 3.3 | | | 3.3 | | | | |
| | $I_O = -20\text{ mA}$ | 25°C | 1.5 | 2.3 | | 1.5 | 2.3 | | | |
| | | Full range | 1.4 | | | 1.4 | | | | |
| V_{OM-} Maximum negative peak output voltage swing | $I_O = 200\mu\text{A}$ | 25°C | -3.8 | -4.2 | | -3.8 | -4.2 | V | | |
| | | Full range | -3.6 | | | -3.6 | | | | |
| | $I_O = 2\text{ mA}$ | 25°C | -3.5 | -4.1 | | -3.5 | -4.1 | | | |
| | | Full range | -3.3 | | | -3.3 | | | | |
| | $I_O = 20\text{ mA}$ | 25°C | -1.5 | -2.4 | | -1.5 | -2.4 | | | |
| | | Full range | -1.4 | | | -1.4 | | | | |
| A_{VD} Large-signal differential voltage amplification | $V_O = \pm 2.3\text{ V}$ | $R_L = 600\Omega$ | 25°C | 80 | 91 | | 80 | 91 | dB | |
| | | | Full range | 78 | | | 78 | | | |
| | | $R_L = 2\text{ k}\Omega$ | 25°C | 90 | 100 | | 90 | 100 | | |
| | | | Full range | 88 | | | 88 | | | |
| | | $R_L = 10\text{ k}\Omega$ | 25°C | 95 | 106 | | 95 | 106 | | |
| | | | Full range | 93 | | | 93 | | | |
| r_i Input resistance | $V_{IC} = 0$ | 25°C | 10^{12} | | | 10^{12} | | | Ω | |
| c_i Input capacitance | Common mode | $V_{IC} = 0, \text{See Figure 5}$ | 25°C | 11 | | | 11 | | | pF |
| | Differential | | 25°C | 2.5 | | | 2.5 | | | |
| z_o Open-loop output impedance | $f = 1\text{ MHz}$ | 25°C | 80 | | | 80 | | | Ω | |
| CMRR Common-mode rejection ratio | $V_{IC} = V_{ICRmin}, V_O = 0, R_S = 50\Omega$ | 25°C | 70 | 89 | | 70 | 89 | dB | | |
| | | Full range | 68 | | | 68 | | | | |
| k_{SVR} Supply-voltage rejection ratio ($\Delta V_{CC\pm} / \Delta V_{IO}$) | $V_{CC\pm} = \pm 5\text{ V to } \pm 15\text{ V}, V_O = 0, R_S = 50\Omega$ | 25°C | 82 | 99 | | 82 | 99 | dB | | |
| | | Full range | 80 | | | 80 | | | | |

[†] Full range is -55°C to 125°C .

[‡] On products compliant to MIL-PRF-38535, Class B, this parameter is not production tested.



TLE207x, TLE207xA
EXCALIBUR LOW-NOISE HIGH-SPEED
JFET-INPUT OPERATIONAL AMPLIFIERS

SLOS181C – FEBRUARY 1997 – REVISED DECEMBER 2009

TLE2074M electrical characteristics at specified free-air temperature, $V_{CC\pm} = \pm 5\text{ V}$ (unless otherwise noted) (continued)

| PARAMETER | TEST CONDITIONS | T_A^\dagger | TLE2074M | | | TLE2074AM | | | UNIT | |
|-----------|-------------------------------------|--------------------------------------------|------------|------------------------|-----|-----------|-----|-----|------|----|
| | | | MIN | TYP | MAX | MIN | TYP | MAX | | |
| I_{CC} | Supply current (four amplifiers) | $V_O = 0$, No load | 25°C | 5.2 | 6.3 | 7.5 | 5.2 | 6.3 | 7.5 | mA |
| | | | Full range | 7.5 | | | 7.5 | | | |
| | Crosstalk attenuation | $V_{IC} = 0$, $R_L = 2\text{ k}\Omega$ | 25°C | 120 | | | 120 | | | dB |
| I_{OS} | Short-circuit output current | $V_O = 0$ | 25°C | $V_{ID} = 1\text{ V}$ | | | -35 | | | mA |
| | | | | $V_{ID} = -1\text{ V}$ | | | 45 | | | |

† Full range is -55°C to 125°C .

TLE2074M operating characteristics at specified free-air temperature, $V_{CC\pm} = \pm 5\text{ V}$

| PARAMETER | TEST CONDITIONS | T_A^\dagger | TLE2074M | | | TLE2074AM | | | UNIT | |
|-------------|---------------------------------------------|------------------------------------------------------------------------------------------------------------------------------|-------------------------------------------------------|----------------|----------------|-----------|----------------|----------------|------|------------------------|
| | | | MIN | TYP | MAX | MIN | TYP | MAX | | |
| SR+ | Positive slew rate | $V_{O(PP)} = \pm 2.3\text{ V}$, $A_{VD} = -1$, $R_L = 2\text{ k}\Omega$, $C_L = 100\text{ pF}$, See Figure 1 | 25°C | 35 | | | 35 | | | V/ μs |
| | | | Full range | 18 ‡ | | | 18 ‡ | | | |
| SR- | Negative slew rate | | 25°C | 38 | | | 38 | | | V/ μs |
| | | | Full range | 18 ‡ | | | 18 ‡ | | | |
| t_s | Settling time | $A_{VD} = -1$, 2-V step, $R_L = 1\text{ k}\Omega$, $C_L = 100\text{ pF}$ | To 10 mV | 0.25 | | | 0.25 | | | μs |
| | | | To 1 mV | 0.4 | | | 0.4 | | | |
| V_n | Equivalent input noise voltage | | f = 10 Hz | 48 | 85 ‡ | | 48 | 85 ‡ | | nV/ $\sqrt{\text{Hz}}$ |
| | | | f = 10 kHz | 12 | 17 ‡ | | 12 | 17 ‡ | | |
| $V_{N(PP)}$ | Peak-to-peak equivalent input noise voltage | $R_S = 20\ \Omega$, See Figure 3 | f = 10 Hz to 10 kHz | 6 | | | 6 | | | μV |
| | | | f = 0.1 Hz to 10 Hz | 0.6 | | | 0.6 | | | |
| I_n | Equivalent input noise current | $V_{IC} = 0$, f = 10 kHz | 25°C | 2.8 | | | 2.8 | | | fA/ $\sqrt{\text{Hz}}$ |
| THD + N | Total harmonic distortion plus noise | $V_{O(PP)} = 5\text{ V}$, f = 1 kHz, $R_S = 25\ \Omega$ | $A_{VD} = 10$, $R_L = 2\text{ k}\Omega$, 25°C | 0.013% | | | 0.013% | | | |
| B_1 | Unity-gain bandwidth | $V_I = 10\text{ mV}$, $C_L = 25\text{ pF}$, $R_L = 2\text{ k}\Omega$, See Figure 2 | 25°C | 9.4 | | | 9.4 | | | MHz |
| B_{OM} | Maximum output-swing bandwidth | $V_{O(PP)} = 4\text{ V}$, $R_L = 2\text{ k}\Omega$, $C_L = 25\text{ pF}$ | $A_{VD} = -1$, $C_L = 25\text{ pF}$, 25°C | 2.8 | | | 2.8 | | | MHz |
| f_m | Phase margin at unity gain | $V_I = 10\text{ mV}$, $C_L = 25\text{ pF}$, $R_L = 2\text{ k}\Omega$, See Figure 2 | 25°C | 56° | | | 56° | | | |

† Full range is -55°C to 125°C .

‡ On products compliant to MIL-PRF-38535, Class B, this parameter is not production tested.



TLE207x, TLE207xA
EXCALIBUR LOW-NOISE HIGH-SPEED
JFET-INPUT OPERATIONAL AMPLIFIERS

SLOS181C – FEBRUARY 1997 – REVISED DECEMBER 2009

TLE2074M electrical characteristics at specified free-air temperature, $V_{CC\pm} = \pm 15$ V (unless otherwise noted)

| PARAMETER | TEST CONDITIONS | T_A^\dagger | TLE2074M | | | TLE2074AM | | | UNIT | |
|---------------------------------------------------------------------------------|----------------------------------------------------------------------------------------|-------------------------------|-------------|-----------------|------|-------------|-----------------|------------------------------|----------|----|
| | | | MIN | TYP | MAX | MIN | TYP | MAX | | |
| V_{IO} Input offset voltage | $V_{IC} = 0, V_O = 0,$ $R_S = 50 \Omega$ | 25°C | -1.6 | 5 | | -0.5 | 3 | mV | | |
| | | Full range | | | 10.5 | | 8.5 | | | |
| α_{VIO} Temperature coefficient of input offset voltage | | Full range | 10.1 | 30 [‡] | | 10.1 | 30 [‡] | $\mu\text{V}/^\circ\text{C}$ | | |
| I_{IO} Input offset current | $V_{IC} = 0, V_O = 0,$ See Figure 4 | 25°C | 15 | 100 | | 15 | 100 | pA | | |
| | | Full range | | 20 | | 20 | | nA | | |
| I_{IB} Input bias current | | 25°C | 25 | 175 | | 25 | 175 | pA | | |
| | | Full range | | 60 | | 60 | | nA | | |
| V_{ICR} Common-mode input voltage range | $R_S = 50 \Omega$ | 25°C | 15 to -11 | 15 to -11.9 | | 15 to -11 | 15 to -11.9 | V | | |
| | | Full range | 15 to -10.8 | | | 15 to -10.8 | | | | |
| V_{OM+} Maximum positive peak output voltage swing | $I_O = -200 \mu\text{A}$ | 25°C | 13.8 | 14.1 | | 13.8 | 14.1 | V | | |
| | | Full range | 13.6 | | | 13.6 | | | | |
| | $I_O = -2 \text{ mA}$ | 25°C | 13.5 | 13.9 | | 13.5 | 13.9 | | | |
| | | Full range | 13.3 | | | 13.3 | | | | |
| | $I_O = -20 \text{ mA}$ | 25°C | 11.5 | 12.3 | | 11.5 | 12.3 | | | |
| | | Full range | 11.4 | | | 11.4 | | | | |
| V_{OM-} Maximum negative peak output voltage swing | $I_O = 200 \mu\text{A}$ | 25°C | -13.8 | -14.2 | | -13.8 | -14.2 | V | | |
| | | Full range | -13.6 | | | -13.6 | | | | |
| | $I_O = 2 \text{ mA}$ | 25°C | -13.5 | -14 | | -13.5 | -14 | | | |
| | | Full range | -13.3 | | | -13.3 | | | | |
| | $I_O = 20 \text{ mA}$ | 25°C | -11.5 | -12.4 | | -11.5 | -12.4 | | | |
| | | Full range | -11.4 | | | -11.4 | | | | |
| A_{VD} Large-signal differential voltage amplification | $V_O = \pm 10 \text{ V}$ | $R_L = 600 \Omega$ | 25°C | 80 | 96 | | 80 | 96 | dB | |
| | | | Full range | 78 | | | 78 | | | |
| | | $R_L = 2 \text{ k}\Omega$ | 25°C | 90 | 109 | | 90 | 109 | | |
| | | | Full range | 88 | | | 88 | | | |
| | | $R_L = 10 \text{ k}\Omega$ | 25°C | 95 | 118 | | 95 | 118 | | |
| | | | Full range | 93 | | | 93 | | | |
| r_i Input resistance | $V_{IC} = 0$ | 25°C | 10^{12} | | | 10^{12} | | | Ω | |
| c_i Input capacitance | Common mode | $V_{IC} = 0,$ See Figure 5 | 25°C | 7.5 | | | 7.5 | | | pF |
| | Differential | | 25°C | 2.5 | | | 2.5 | | | |
| z_o Open-loop output impedance | $f = 1 \text{ MHz}$ | 25°C | 80 | | | 80 | | | Ω | |
| CMRR Common-mode rejection ratio | $V_{IC} = V_{ICRmin},$ $V_O = 0,$ $R_S = 50 \Omega$ | 25°C | 80 | 98 | | 80 | 98 | dB | | |
| | | Full range | 78 | | | 78 | | | | |
| k_{SVR} Supply-voltage rejection ratio ($\Delta V_{CC\pm} / \Delta V_{IO}$) | $V_{CC\pm} = \pm 5 \text{ V to } \pm 15 \text{ V},$ $V_O = 0,$ $R_S = 50 \Omega$ | 25°C | 82 | 99 | | 82 | 99 | dB | | |
| | | Full range | 80 | | | 80 | | | | |

[†] Full range is -55°C to 125°C.

[‡] On products compliant to MIL-PRF-38535, Class B, this parameter is not production tested.



TLE207x, TLE207xA EXCALIBUR LOW-NOISE HIGH-SPEED JFET-INPUT OPERATIONAL AMPLIFIERS

SLOS181C – FEBRUARY 1997 – REVISED DECEMBER 2009

TLE2074M electrical characteristics at specified free-air temperature, $V_{CC\pm} = \pm 15$ V (unless otherwise noted) (continued)

| PARAMETER | TEST CONDITIONS | T_A † | TLE2074M | | | TLE2074AM | | | UNIT | |
|-----------|-------------------------------------|----------------------------------------|------------|-----------------|-----|-----------|-----|-----|------|----|
| | | | MIN | TYP | MAX | MIN | TYP | MAX | | |
| I_{CC} | Supply current (four amplifiers) | $V_O = 0$, No load | 25°C | 5.2 | 6.5 | 7.5 | 5.2 | 6.5 | 7.5 | mA |
| | | | Full range | 7.5 | | | 7.5 | | | |
| | Crosstalk attenuation | $V_{IC} = 0$, $R_L = 2$ k Ω | 25°C | 120 | | | 120 | | | dB |
| I_{OS} | Short-circuit output current | $V_O = 0$ | 25°C | $V_{ID} = 1$ V | -30 | -45 | -30 | -45 | mA | |
| | | | | $V_{ID} = -1$ V | 30 | 48 | 30 | 48 | | |

† Full range is -55°C to 125°C .

TLE2074M operating characteristics at specified free-air temperature, $V_{CC\pm} = \pm 15$ V

| PARAMETER | TEST CONDITIONS | T_A † | TLE2074M | | | TLE2074AM | | | UNIT |
|-------------|---------------------------------------------|-----------------------------------------------------------------------------------|----------|---------------------|-----|-----------|-----|------------------------|------------------------|
| | | | MIN | TYP | MAX | MIN | TYP | MAX | |
| SR+ | Positive slew rate | $V_{O(PP)} = 10$ V, $R_L = 2$ k Ω , See Figure 1 | 25°C | 25 | 40 | | 25 | 40 | V/ μ s |
| | | | | Full range | 17 | | | 17 | |
| SR- | Negative slew rate | $V_{O(PP)} = 10$ V, $R_L = 2$ k Ω , See Figure 1 | 25°C | 30 | 45 | | 30 | 45 | V/ μ s |
| | | | | Full range | 20 | | | 20 | |
| t_s | Settling time | $A_{VD} = -1$, 10-V step, $R_L = 1$ k Ω , $C_L = 100$ pF | 25°C | To 10 mV | 0.4 | | 0.4 | | μ s |
| | | | | To 1 mV | 1.5 | | 1.5 | | |
| V_n | Equivalent input noise voltage | $R_S = 20$ Ω , See Figure 3 | 25°C | f = 10 Hz | 48 | 85‡ | 48 | 85‡ | nV/ $\sqrt{\text{Hz}}$ |
| | | | | f = 10 kHz | 12 | 17‡ | 12 | 17‡ | |
| $V_{N(PP)}$ | Peak-to-peak equivalent input noise voltage | $R_S = 20$ Ω , See Figure 3 | 25°C | f = 10 Hz to 10 kHz | 6 | | 6 | | μ V |
| | | | | f = 0.1 Hz to 10 Hz | 0.6 | | 0.6 | | |
| I_n | Equivalent input noise current | $V_{IC} = 0$, f = 10 kHz | 25°C | 2.8 | | 2.8 | | fA/ $\sqrt{\text{Hz}}$ | |
| THD + N | Total harmonic distortion plus noise | $V_{O(PP)} = 20$ V, f = 1 kHz, $R_S = 25$ Ω | 25°C | 0.008% | | 0.008% | | | |
| B_1 | Unity-gain bandwidth | $V_I = 10$ mV, $C_L = 25$ pF, $R_L = 2$ k Ω , See Figure 2 | 25°C | 8‡ | 10 | 8‡ | 10 | MHz | |
| B_{OM} | Maximum output-swing bandwidth | $V_{O(PP)} = 20$ V, $R_L = 2$ k Ω , $A_{VD} = -1$, $C_L = 25$ pF | 25°C | 478‡ | 637 | 478‡ | 637 | kHz | |
| ϕ_m | Phase margin at unity gain | $V_I = 10$ mV, $C_L = 25$ pF, $R_L = 2$ k Ω , See Figure 2 | 25°C | 57° | | 57° | | | |

† Full range is -55°C to 125°C .

‡ On products compliant to MIL-PRF-38535, Class B, this parameter is not production tested.



TLE207x, TLE207xA
EXCALIBUR LOW-NOISE HIGH-SPEED
JFET-INPUT OPERATIONAL AMPLIFIERS

SLOS181C – FEBRUARY 1997 – REVISED DECEMBER 2009

TLE2074Y electrical characteristics at $V_{CC\pm} = \pm 15$ V, $T_A = 25^\circ\text{C}$ (unless otherwise noted)

| PARAMETER | | TEST CONDITIONS | | TLE2074Y | | | UNIT |
|-----------|---------------------------------------------------------------------|----------------------------------------------------------------------------------------|------------|----------------------------|------------------|-----|----------|
| | | | | MIN | TYP | MAX | |
| V_{IO} | Input offset voltage | $V_{IC} = 0,$ $R_S = 50 \Omega$ | $V_O = 0,$ | | | 5 | mV |
| I_{IO} | Input offset current | $V_{IC} = 0,$ | $V_O = 0,$ | | 15 | 100 | pA |
| I_{IB} | Input bias current | See Figure 4 | | | 25 | 175 | pA |
| V_{ICR} | Common-mode input voltage range | $R_S = 50 \Omega$ | | 15 to -11 | 15 to 11.9 | | V |
| V_{OM+} | Maximum positive peak output voltage swing | $I_O = -200 \mu\text{A}$ | | 13.8 | 14.1 | | V |
| | | $I_O = -2 \text{ mA}$ | | 13.5 | 13.9 | | |
| | | $I_O = -20 \text{ mA}$ | | 11.5 | 12.3 | | |
| V_{OM-} | Maximum negative peak output voltage swing | $I_O = 200 \mu\text{A}$ | | -13.8 | -14.2 | | V |
| | | $I_O = 2 \text{ mA}$ | | -13.5 | -14 | | |
| | | $I_O = 20 \text{ mA}$ | | -11.5 | -12.4 | | |
| A_{VD} | Large-signal differential voltage amplification | $V_O = \pm 10 \text{ V}$ | | $R_L = 600 \Omega$ | 80 | 96 | dB |
| | | | | $R_L = 2 \text{ k}\Omega$ | 90 | 109 | |
| | | | | $R_L = 10 \text{ k}\Omega$ | 95 | 118 | |
| r_i | Input resistance | $V_{IC} = 0$ | | 10^{12} | | | Ω |
| c_i | Input capacitance | Common mode | $V_O = 0,$ | See Figure 5 | 7.5 | | pF |
| | | Differential | | | 2.5 | | |
| z_o | Open-loop output impedance | $f = 1 \text{ MHz}$ | | 80 | | | Ω |
| CMRR | Common-mode rejection ratio | $V_{IC} = V_{ICRmin},$ $R_S = 50 \Omega$ | $V_O = 0,$ | 80 | 98 | | dB |
| k_{SVR} | Supply-voltage rejection ratio ($\Delta V_{CC\pm}/\Delta V_{IO}$) | $V_{CC\pm} = \pm 5 \text{ V to } \pm 15 \text{ V},$ $V_O = 0,$ $R_S = 50 \Omega$ | | 82 | 99 | | dB |
| I_{CC} | Supply current (four amplifiers) | $V_O = 0,$ | No load | 5.2 | 6.5 | 7.5 | mA |
| I_{OS} | Short-circuit output current | $V_O = 0$ | | $V_{ID} = 1 \text{ V}$ | -30 | -45 | mA |
| | | | | $V_{ID} = -1 \text{ V}$ | 30 | 48 | |

TLE207x, TLE207xA EXCALIBUR LOW-NOISE HIGH-SPEED JFET-INPUT OPERATIONAL AMPLIFIERS

SLOS181C – FEBRUARY 1997 – REVISED DECEMBER 2009

PARAMETER MEASUREMENT INFORMATION

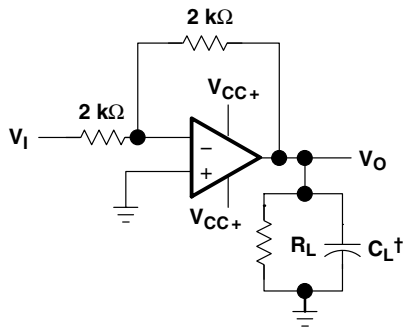

† Includes fixture capacitance

Figure 1. Slew-Rate Test Circuit

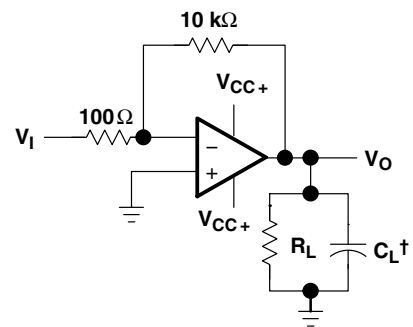

† Includes fixture capacitance

Figure 2. Unity-Gain Bandwidth and Phase-Margin Test Circuit

PARAMETER MEASUREMENT INFORMATION

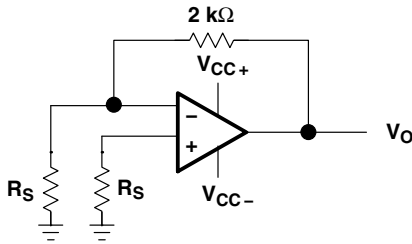

Figure 3. Noise-Voltage Test Circuit

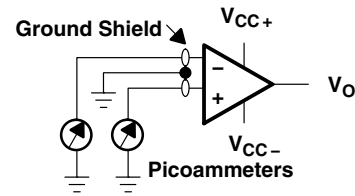

Figure 4. Input-Bias and Offset-Current Test Circuit

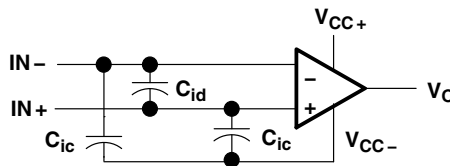

Figure 5. Internal Input Capacitance

typical values

Typical values presented in this data sheet represent the median (50% point) of device parametric performance.

input bias and offset current

At the picoampere bias current level typical of the TLE207x and TLE207xA, accurate measurement of the bias current becomes difficult. Not only does this measurement require a picoammeter but test socket leakages can easily exceed the actual device bias currents. To accurately measure these small currents, Texas Instruments uses a two-step process. The socket leakage is measured using picoammeters with bias voltages applied but with no device in the socket. The device is then inserted in the socket and a second test is performed that measures both the socket leakage and the device input bias current. The two measurements are then subtracted algebraically to determine the bias current of the device.

TLE207x, TLE207xA
EXCALIBUR LOW-NOISE HIGH-SPEED
JFET-INPUT OPERATIONAL AMPLIFIERS

SLOS181C – FEBRUARY 1997 – REVISED DECEMBER 2009

TYPICAL CHARACTERISTICS

Table of Graphs

| | | | FIGURE |
|----------------|---------------------------------------------------|--------------------------------------------------------------------------------|-------------------------------------|
| V_{IO} | Input offset voltage | Distribution | 6, 7, 8 |
| α_{VIO} | Temperature coefficient of input offset voltage | Distribution | 9, 10, 11 |
| I_{IO} | Input offset current | vs Free-air temperature | 12, 13 |
| I_{IB} | Input bias current | vs Free-air temperature vs Total supply voltage | 12, 13 14 |
| V_{ICR} | Common-mode input voltage range | vs Free-air temperature | 15 |
| V_O | Output voltage | vs Differential input voltage | 16, 17 |
| V_{OM+} | Maximum positive peak output voltage | vs Output current | 18 |
| V_{OM-} | Maximum negative peak output voltage | vs Output current | 19 |
| V_{OM} | Maximum peak output voltage | vs Free-air temperature vs Supply voltage | 20, 21 22 |
| $V_{O(PP)}$ | Maximum peak-to-peak output voltage | vs Frequency | 23 |
| V_O | Output voltage | vs Settling time | 24 |
| A_{VD} | Large-signal differential voltage amplification | vs Load resistance vs Free-air temperature | 25 26, 27 |
| A_{VD} | Small-signal differential voltage amplification | vs Frequency | 28, 29 |
| CMRR | Common-mode rejection ratio | vs Frequency vs Free-air temperature | 30 31 |
| k_{SVR} | Supply-voltage rejection ratio | vs Frequency vs Free-air temperature | 32 33 |
| I_{CC} | Supply current | vs Supply voltage vs Free-air temperature vs Differential input voltage | 34, 35, 36 37, 38, 39 40 – 45 |
| I_{OS} | Short-circuit output current | vs Supply voltage vs Elapsed time vs Free-air temperature | 46 47 48 |
| SR | Slew rate | vs Free-air temperature vs Load resistance vs Differential input voltage | 49, 50 51 52 |
| V_n | Equivalent Input noise voltage (spectral density) | vs Frequency | 53 |
| V_n | Input referred noise voltage | vs Noise bandwidth Over a 10-second time interval | 54 55 |
| | Third-octave spectral noise density | vs Frequency bands | 56 |
| THD + N | Total harmonic distortion plus noise | vs Frequency | 57, 58 |
| B_1 | Unity-gain bandwidth | vs Load capacitance | 59 |
| | Gain-bandwidth product | vs Free-air temperature vs Supply voltage | 60 61 |
| | Gain margin | vs Load capacitance | 62 |
| ϕ_m | Phase margin | vs Free-air temperature vs Supply voltage vs Load capacitance | 63 64 65 |
| | Phase shift | vs Frequency | 28, 29 |
| | Noninverting large-signal pulse response | vs Time | 66 |
| | Small-signal pulse response | vs Time | 67 |
| z_o | Closed-loop output impedance | vs Frequency | 68 |
| | Crosstalk attenuation | vs Frequency | 69 |



TYPICAL CHARACTERISTICS

**DISTRIBUTION OF TLE2071
 INPUT OFFSET VOLTAGE**

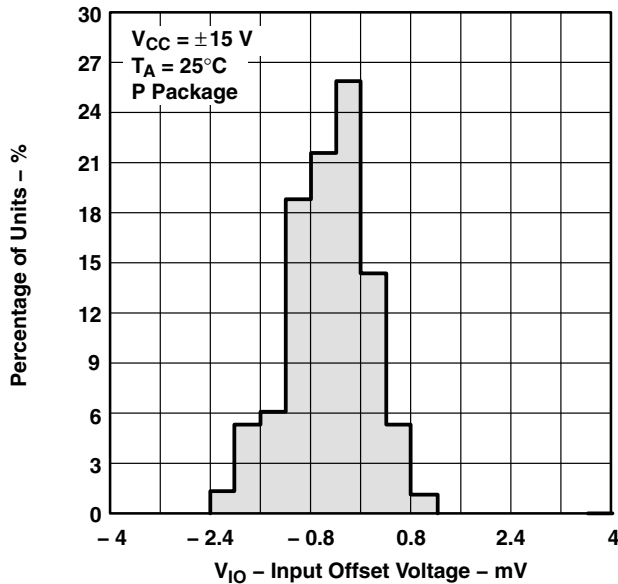

Figure 6

**DISTRIBUTION OF TLE2072
 INPUT OFFSET VOLTAGE**

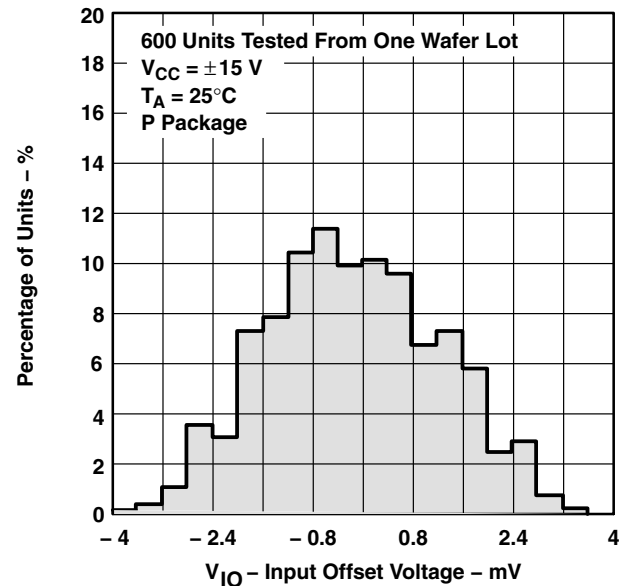

Figure 7

**DISTRIBUTION OF TLE2074
 INPUT OFFSET VOLTAGE**

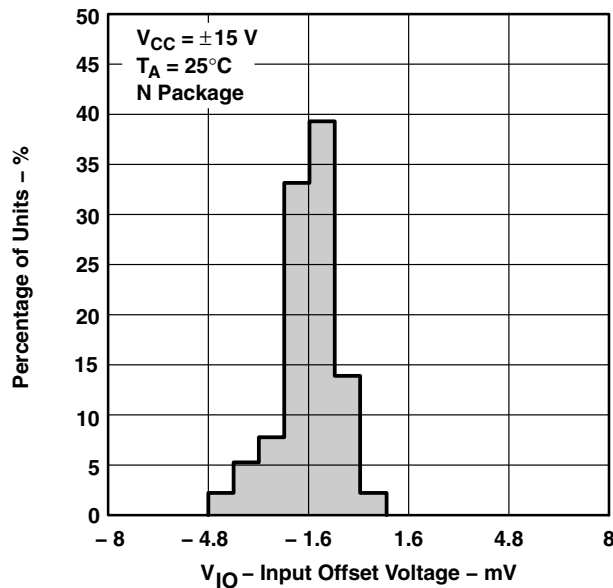

Figure 8

**DISTRIBUTION OF TLE2071 INPUT OFFSET
 VOLTAGE TEMPERATURE COEFFICIENT**

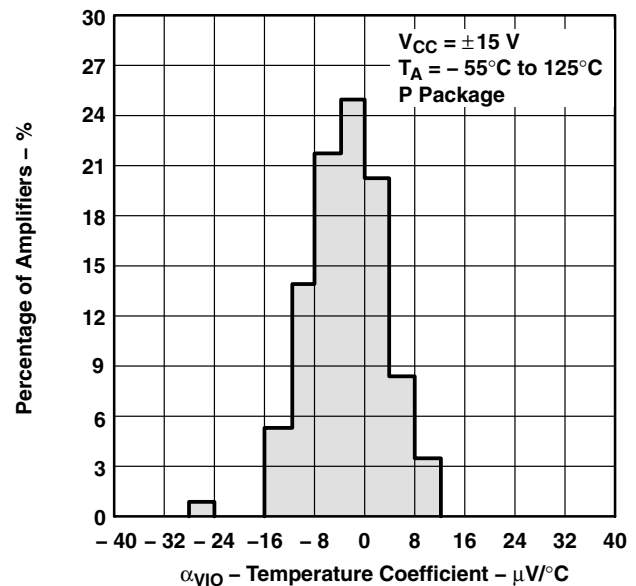

Figure 9

TLE207x, TLE207xA EXCALIBUR LOW-NOISE HIGH-SPEED JFET-INPUT OPERATIONAL AMPLIFIERS

SLOS181C – FEBRUARY 1997 – REVISED DECEMBER 2009

TYPICAL CHARACTERISTICS

**DISTRIBUTION OF TLE2072 INPUT OFFSET
VOLTAGE TEMPERATURE COEFFICIENT**

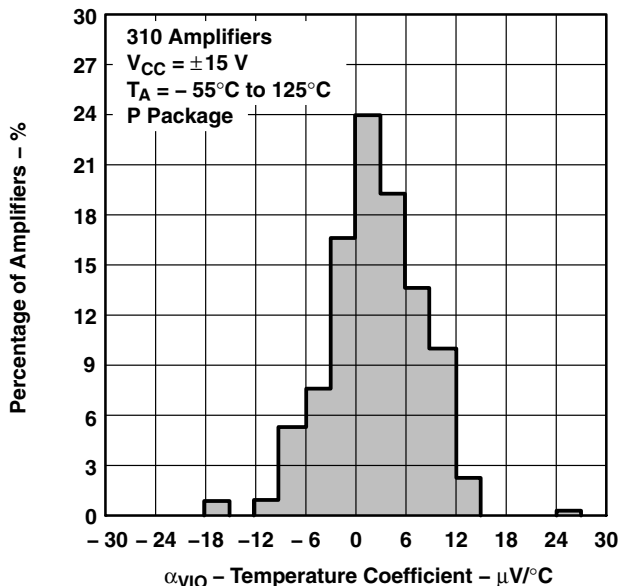

Figure 10

**DISTRIBUTION OF TLE2074 INPUT OFFSET
VOLTAGE TEMPERATURE COEFFICIENT**

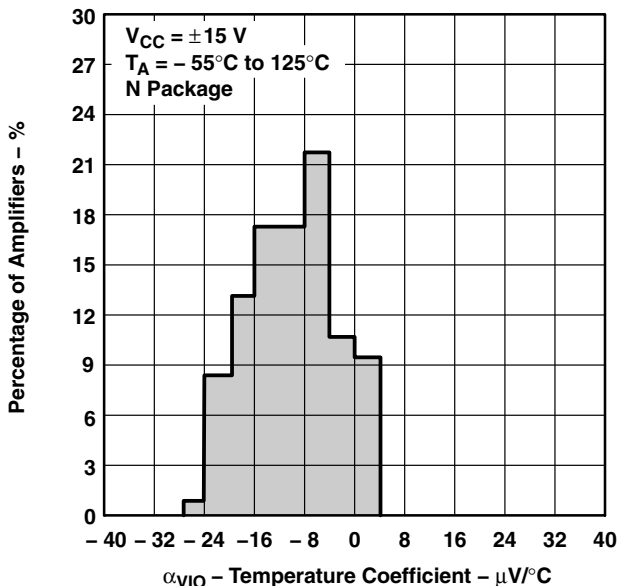

Figure 11

**INPUT BIAS CURRENT AND
INPUT OFFSET CURRENT†
vs
FREE-AIR TEMPERATURE**

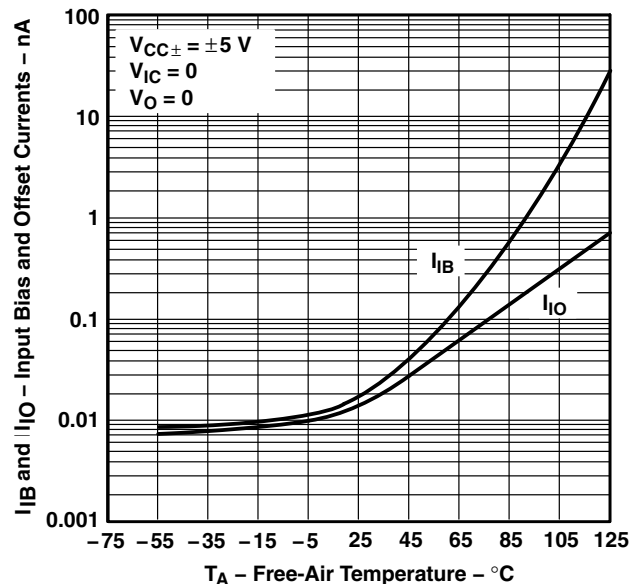

Figure 12

**INPUT BIAS CURRENT AND
INPUT OFFSET CURRENT†
vs
FREE-AIR TEMPERATURE**

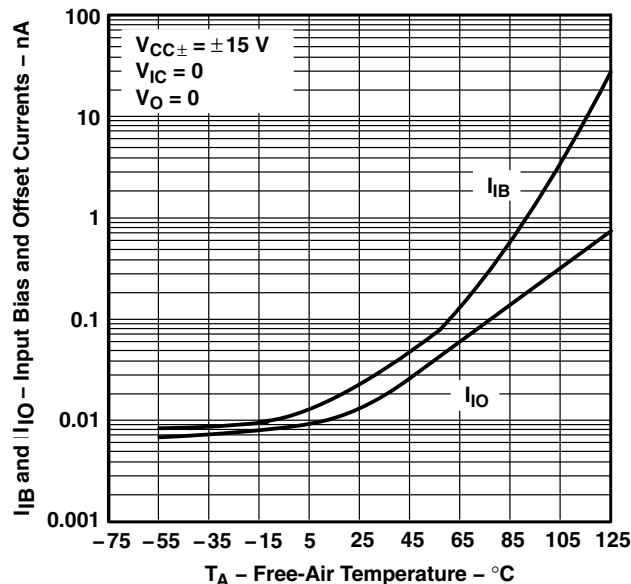
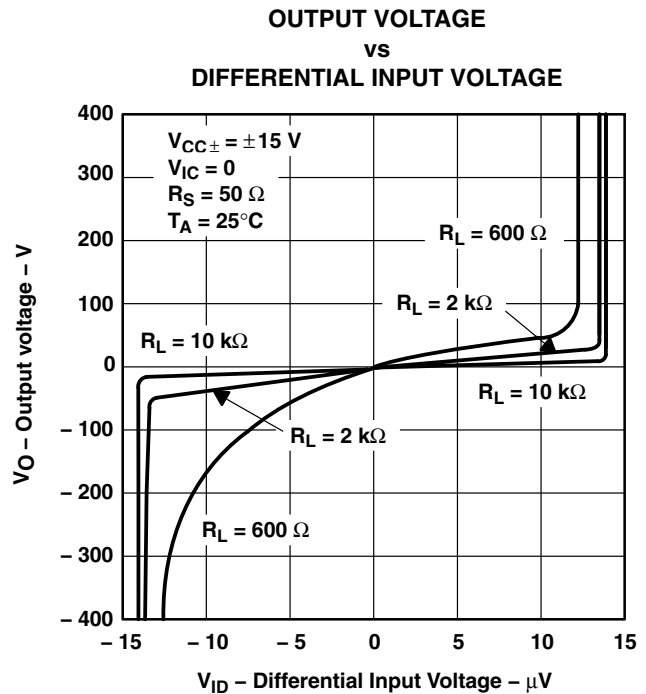
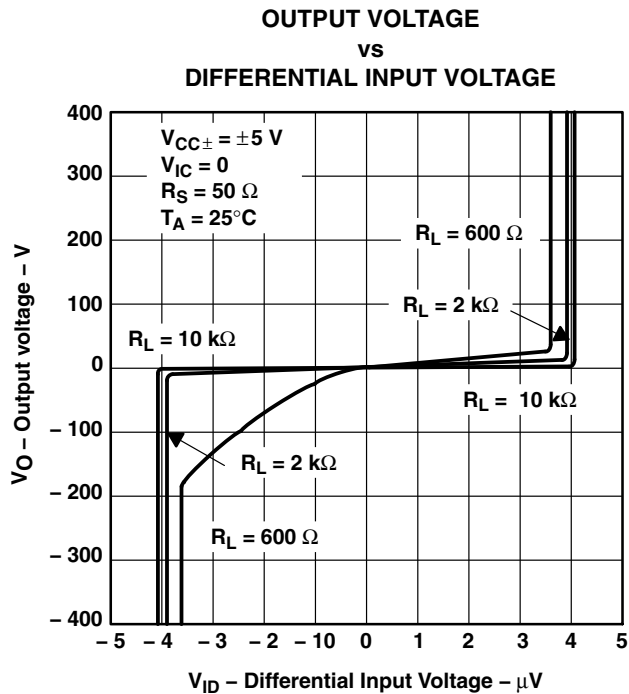
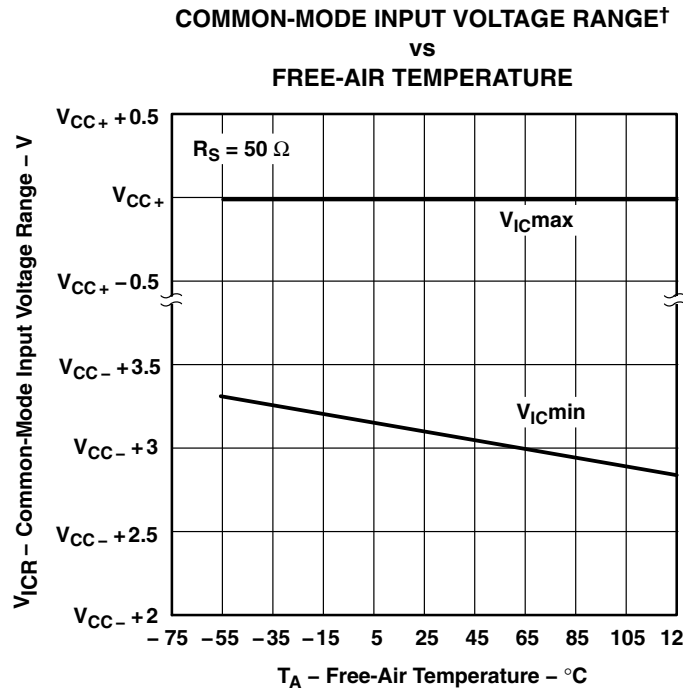
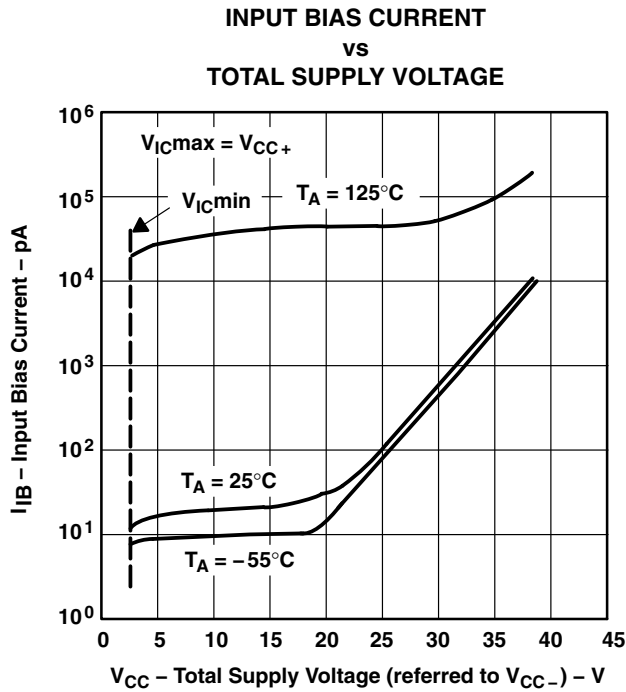

Figure 13

† Data at high and low temperatures are applicable only within the rated operating free-air temperature ranges of the various devices.

TYPICAL CHARACTERISTICS



† Data at high and low temperatures are applicable only within the rated operating free-air temperature ranges of the various devices.

TLE207x, TLE207xA
EXCALIBUR LOW-NOISE HIGH-SPEED
JFET-INPUT OPERATIONAL AMPLIFIERS

SLOS181C – FEBRUARY 1997 – REVISED DECEMBER 2009

TYPICAL CHARACTERISTICS

MAXIMUM POSITIVE PEAK OUTPUT VOLTAGE†
vs
OUTPUT CURRENT

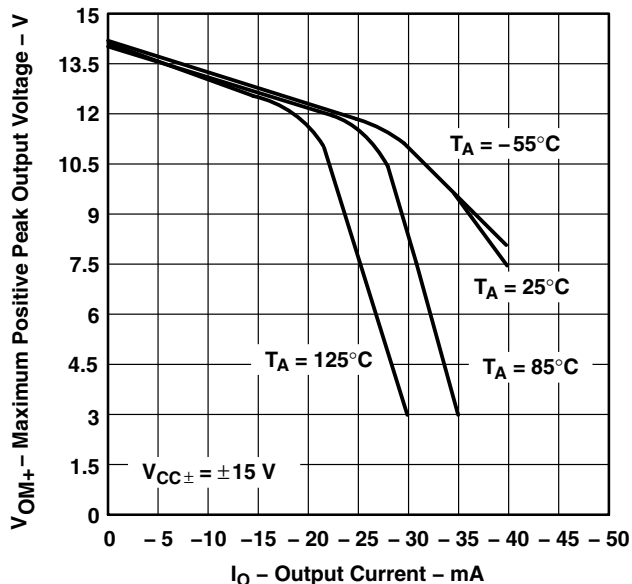

Figure 18

MAXIMUM NEGATIVE PEAK OUTPUT VOLTAGE†
vs
OUTPUT CURRENT

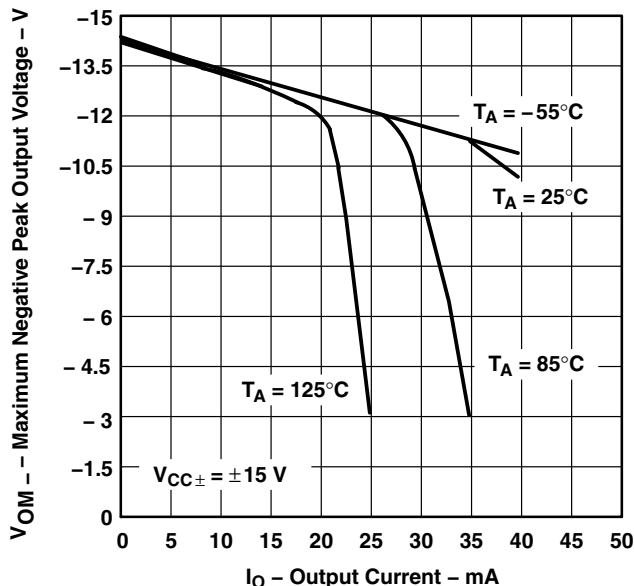

Figure 19

MAXIMUM PEAK OUTPUT VOLTAGE†
vs
FREE-AIR TEMPERATURE

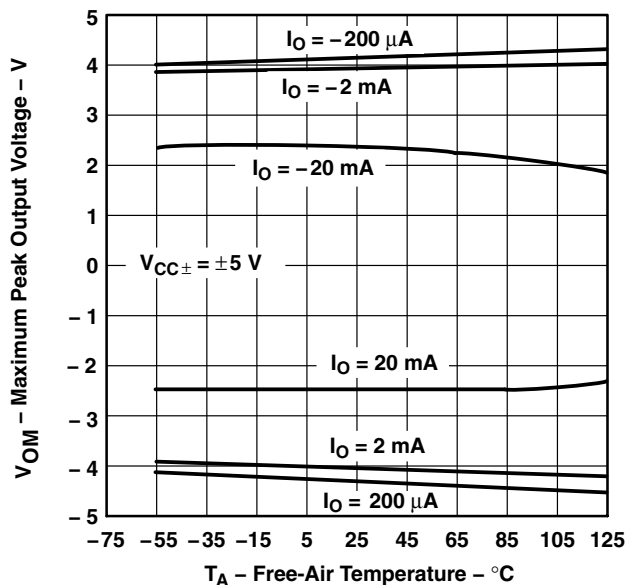

Figure 20

MAXIMUM PEAK OUTPUT VOLTAGE†
vs
FREE-AIR TEMPERATURE

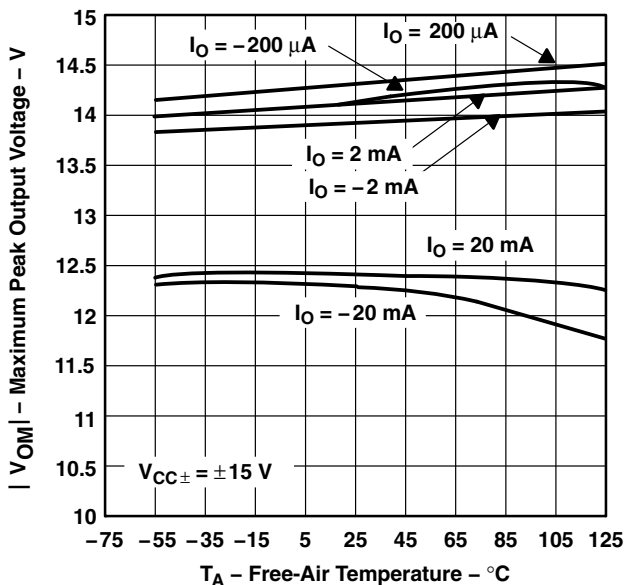

Figure 21

† Data at high and low temperatures are applicable only within the rated operating free-air temperature ranges of the various devices.

TYPICAL CHARACTERISTICS

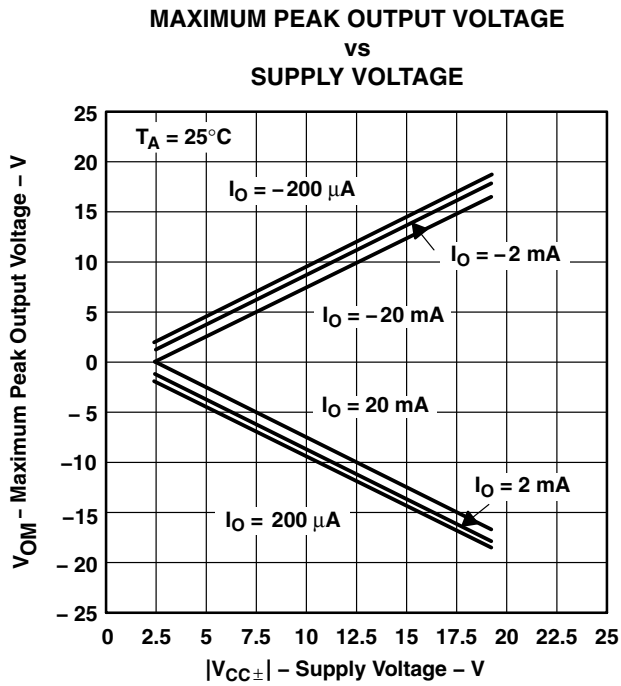

Figure 22

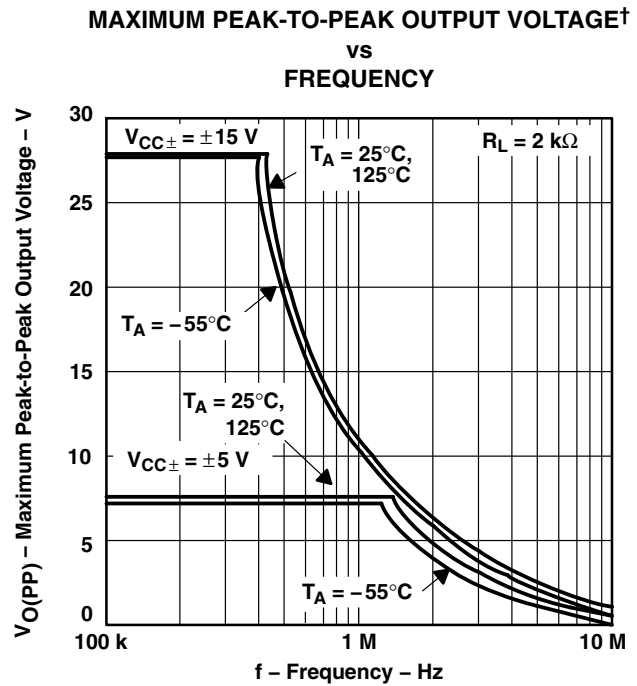

Figure 23

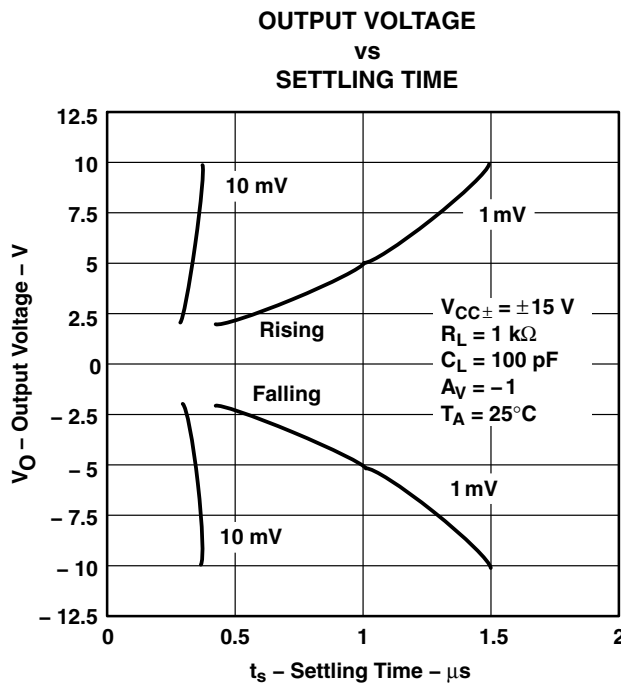

Figure 24

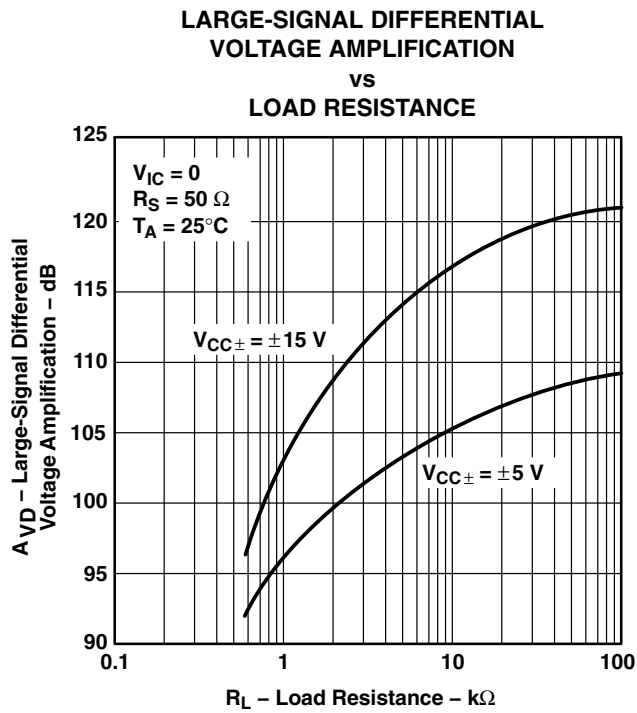

Figure 25

† Data at high and low temperatures are applicable only within the rated operating free-air temperature ranges of the various devices.

TLE207x, TLE207xA
EXCALIBUR LOW-NOISE HIGH-SPEED
JFET-INPUT OPERATIONAL AMPLIFIERS

SLOS181C – FEBRUARY 1997 – REVISED DECEMBER 2009

TYPICAL CHARACTERISTICS

**LARGE-SIGNAL DIFFERENTIAL
VOLTAGE AMPLIFICATION†
vs
FREE-AIR TEMPERATURE**

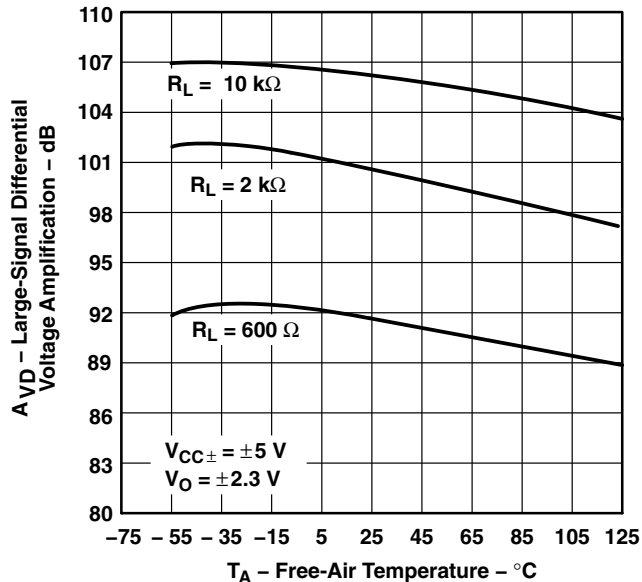

Figure 26

**LARGE-SIGNAL DIFFERENTIAL
VOLTAGE AMPLIFICATION†
vs
FREE-AIR TEMPERATURE**

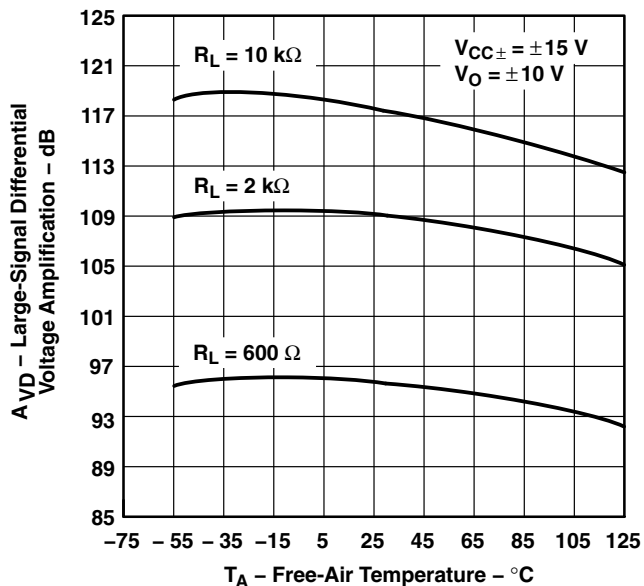

Figure 27

† Data at high and low temperatures are applicable only within the rated operating free-air temperature ranges of the various devices.



TYPICAL CHARACTERISTICS

**SMALL-SIGNAL DIFFERENTIAL VOLTAGE
 AMPLIFICATION AND PHASE SHIFT**

vs
FREQUENCY

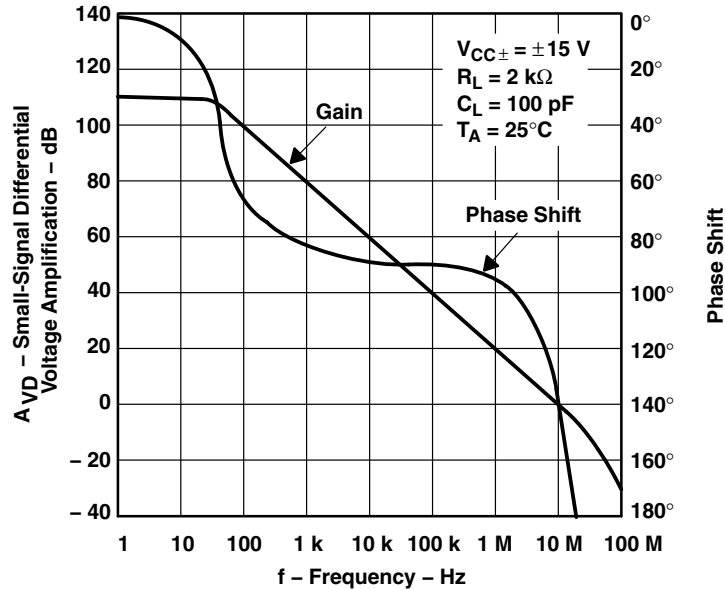

Figure 28

**SMALL-SIGNAL DIFFERENTIAL VOLTAGE
 AMPLIFICATION AND PHASE SHIFT**

vs
FREQUENCY

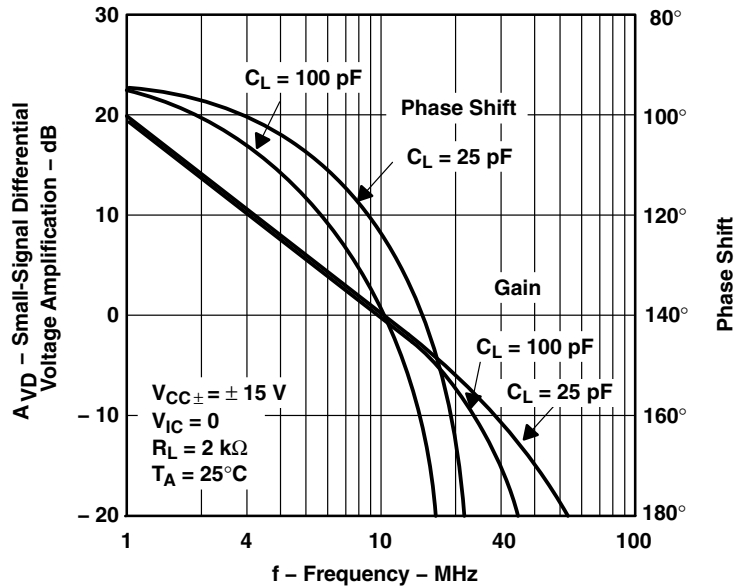

Figure 29

TLE207x, TLE207xA EXCALIBUR LOW-NOISE HIGH-SPEED JFET-INPUT OPERATIONAL AMPLIFIERS

SLOS181C – FEBRUARY 1997 – REVISED DECEMBER 2009

TYPICAL CHARACTERISTICS

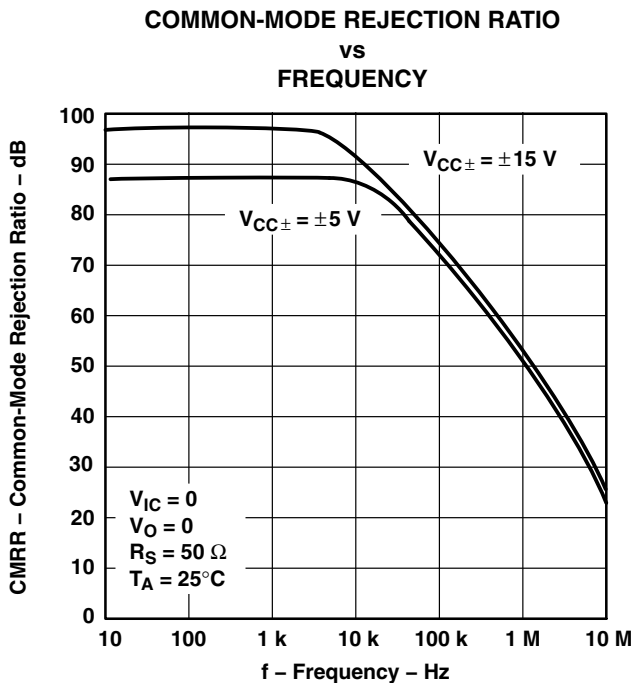

Figure 30

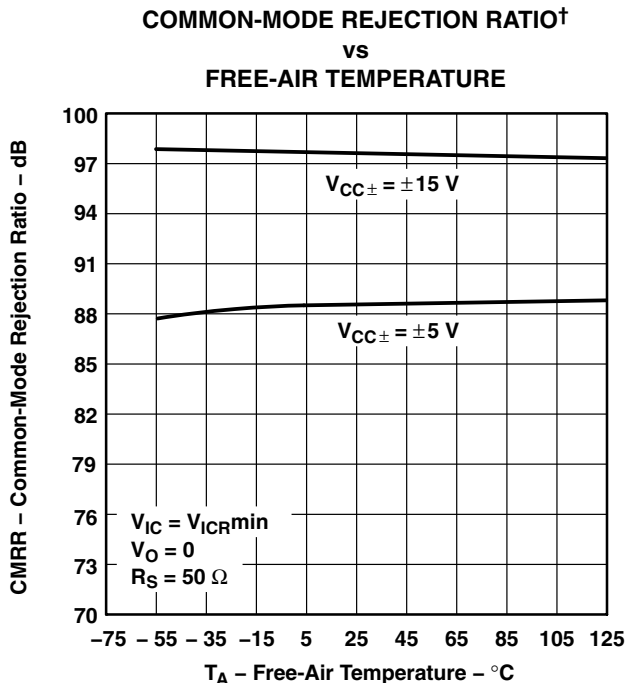

Figure 31

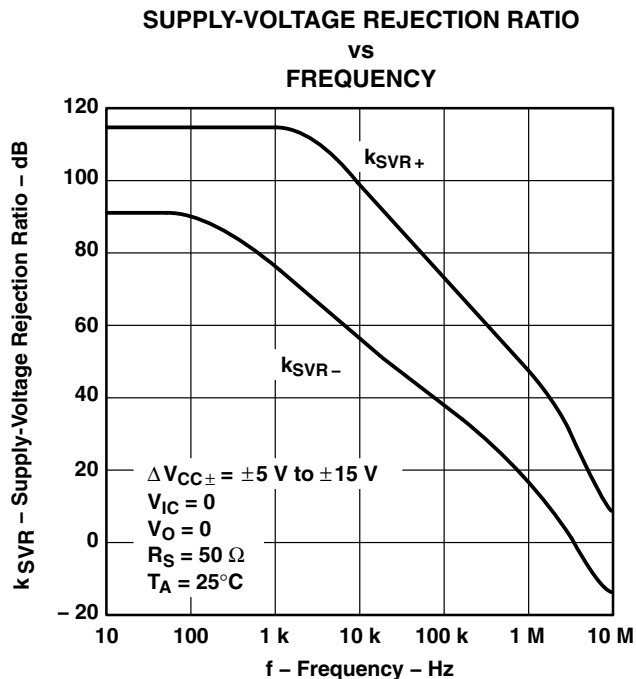

Figure 32

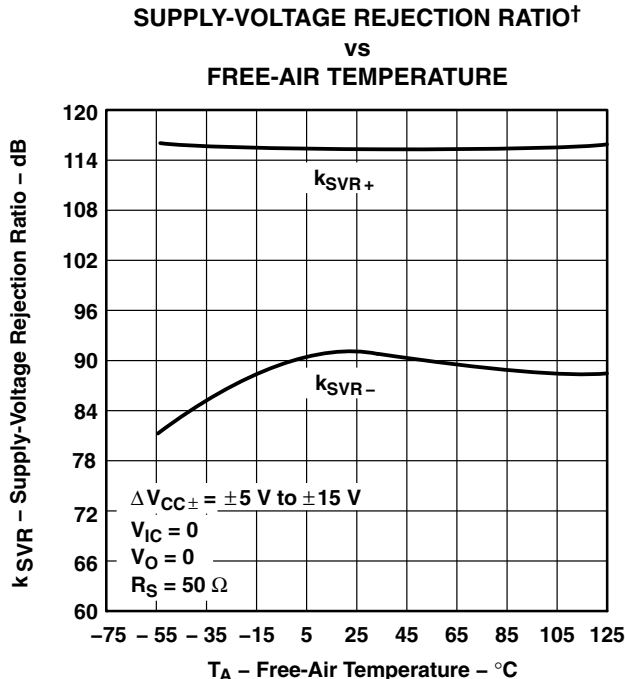

Figure 33

† Data at high and low temperatures are applicable only within the rated operating free-air temperature ranges of the various devices.

TYPICAL CHARACTERISTICS

**TLE2071
 SUPPLY CURRENT
 vs
 SUPPLY VOLTAGE**

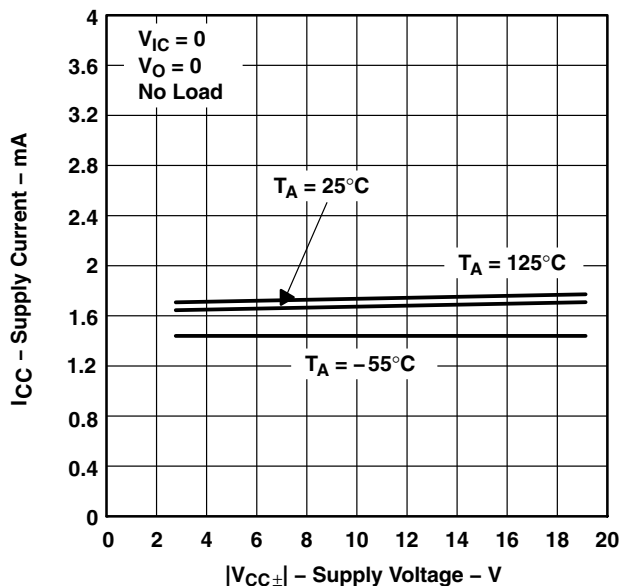

Figure 34

**TLE2072
 SUPPLY CURRENT
 vs
 SUPPLY VOLTAGE**

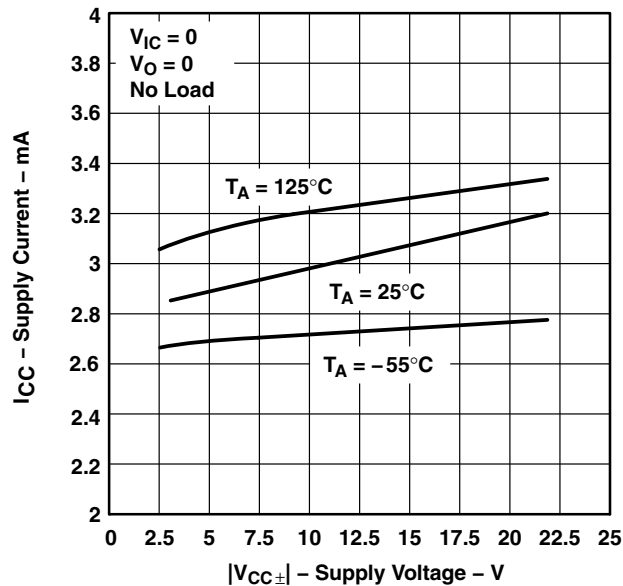

Figure 35

**TLE2074
 SUPPLY CURRENT
 vs
 SUPPLY VOLTAGE**

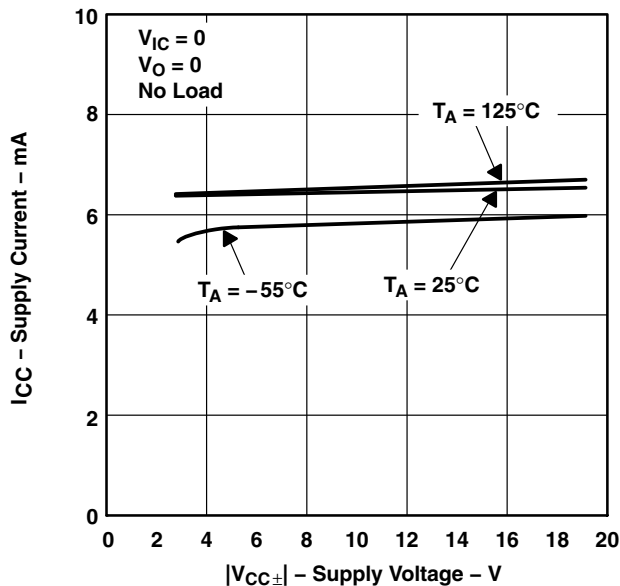

Figure 36

**TLE2071
 SUPPLY CURRENT†
 vs
 FREE-AIR TEMPERATURE**

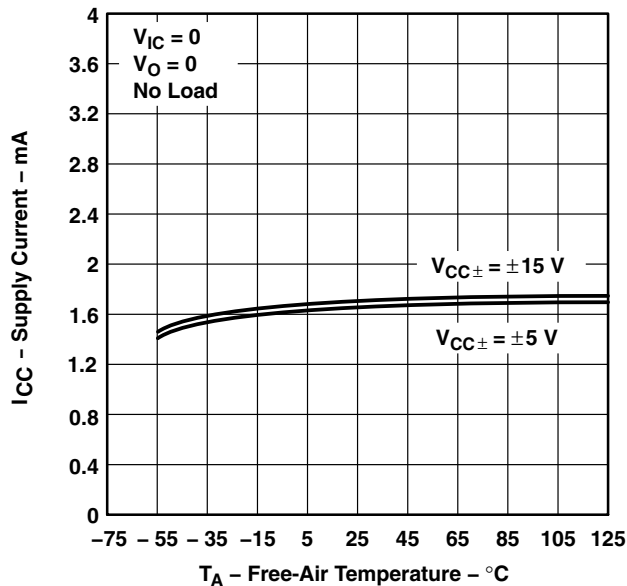

Figure 37

† Data at high and low temperatures are applicable only within the rated operating free-air temperature ranges of the various devices.

TLE207x, TLE207xA EXCALIBUR LOW-NOISE HIGH-SPEED JFET-INPUT OPERATIONAL AMPLIFIERS

SLOS181C – FEBRUARY 1997 – REVISED DECEMBER 2009

TYPICAL CHARACTERISTICS

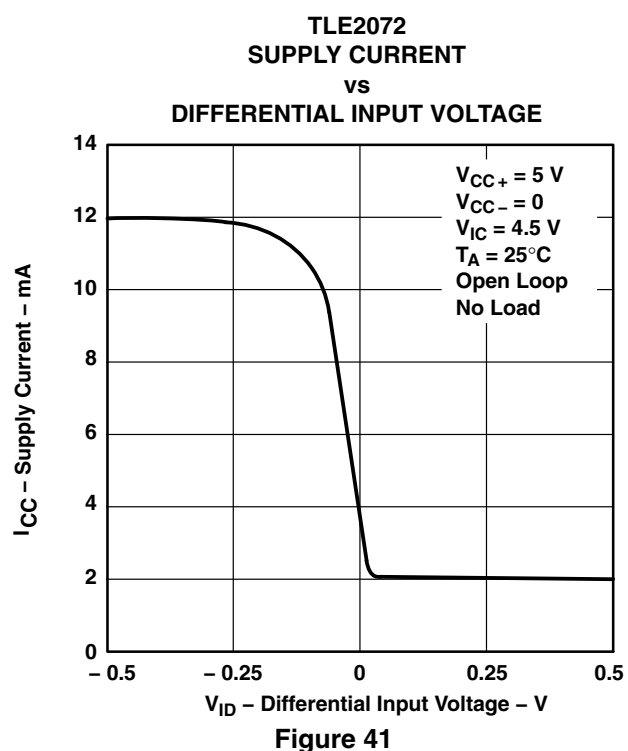
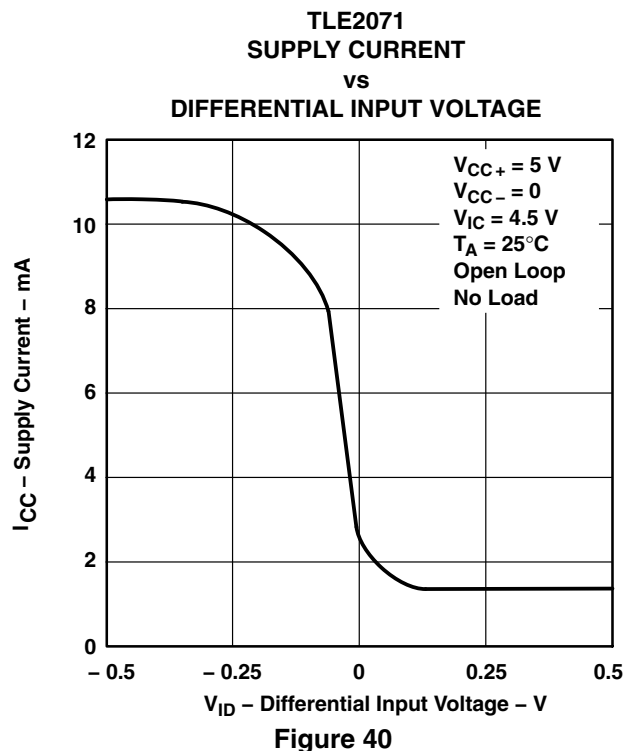
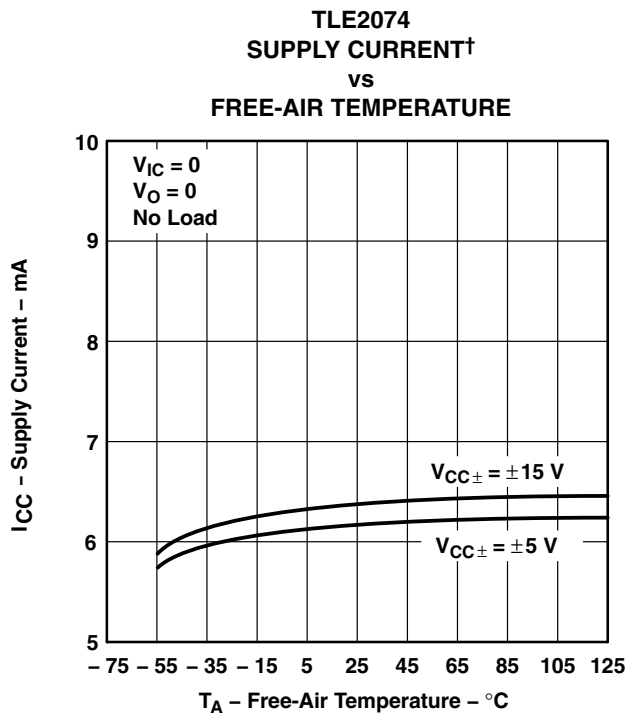
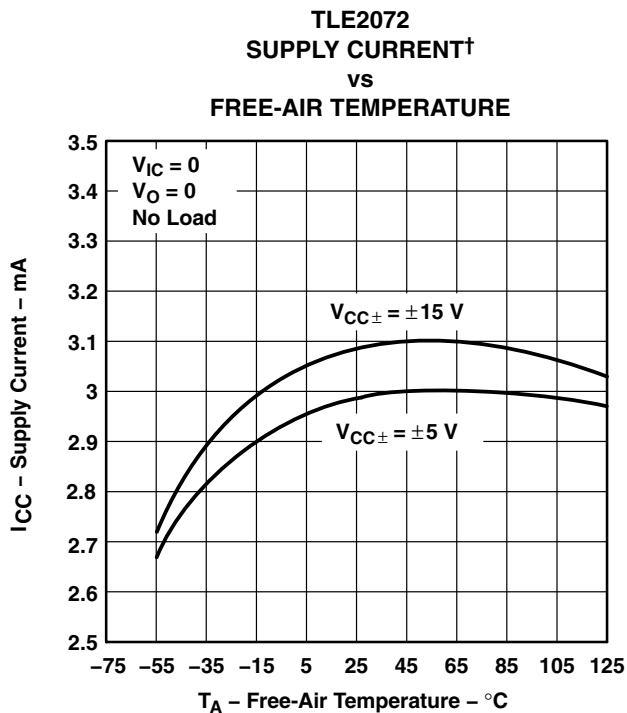

† Data at high and low temperatures are applicable only within the rated operating free-air temperature ranges of the various devices.

TYPICAL CHARACTERISTICS

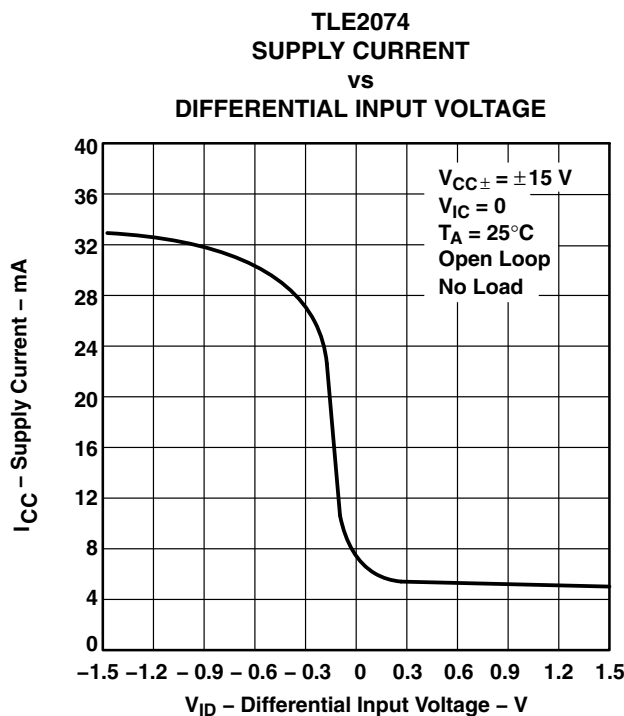
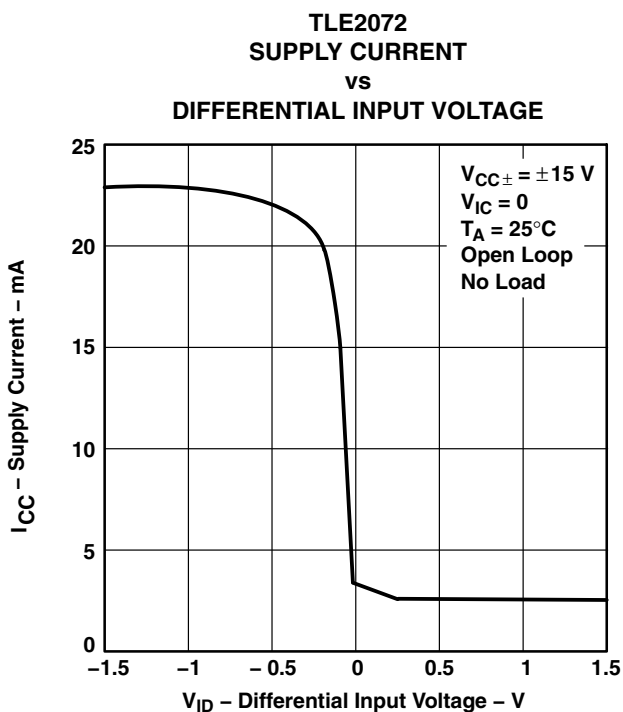
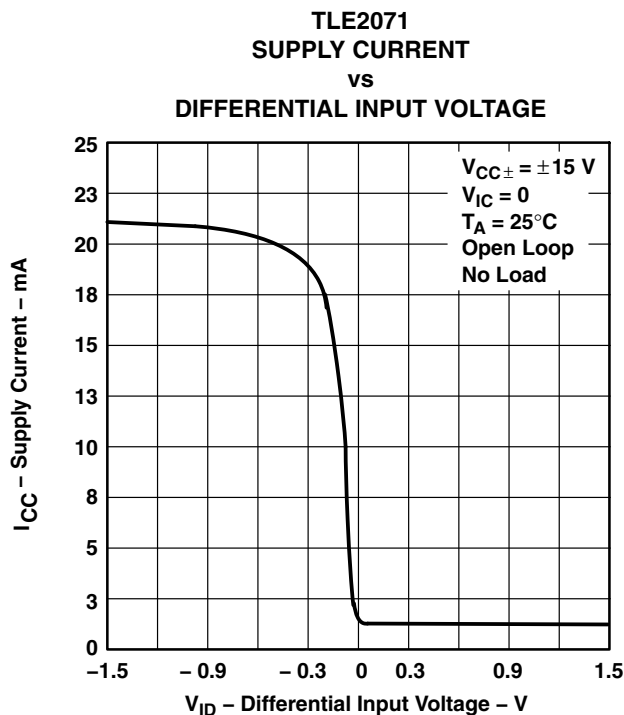
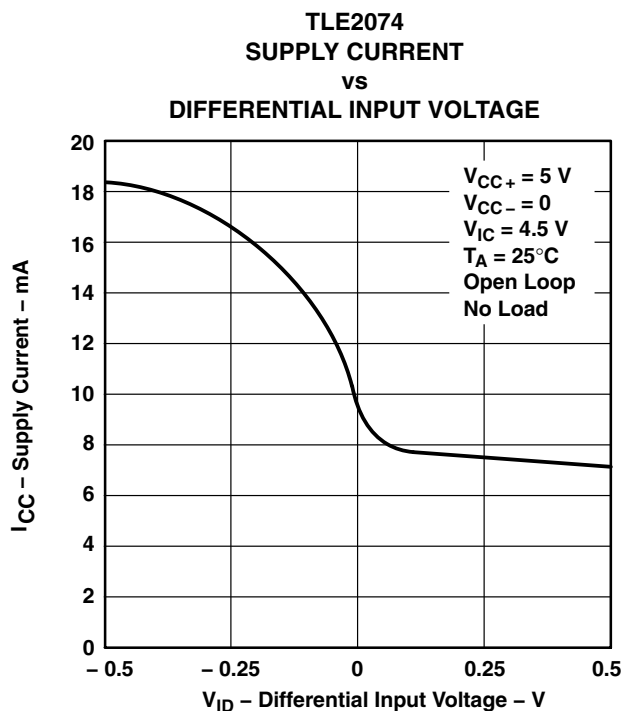

TLE207x, TLE207xA EXCALIBUR LOW-NOISE HIGH-SPEED JFET-INPUT OPERATIONAL AMPLIFIERS

SLOS181C – FEBRUARY 1997 – REVISED DECEMBER 2009

TYPICAL CHARACTERISTICS

SHORT-CIRCUIT OUTPUT CURRENT
vs
SUPPLY VOLTAGE

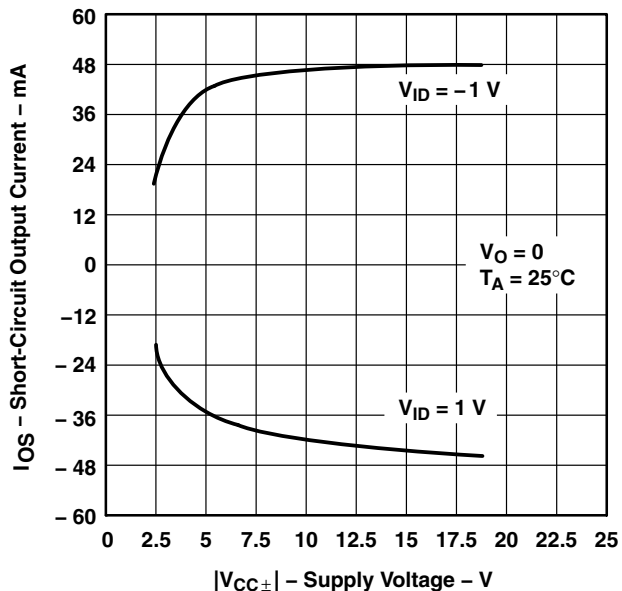

Figure 46

SHORT-CIRCUIT OUTPUT CURRENT
vs
ELAPSED TIME

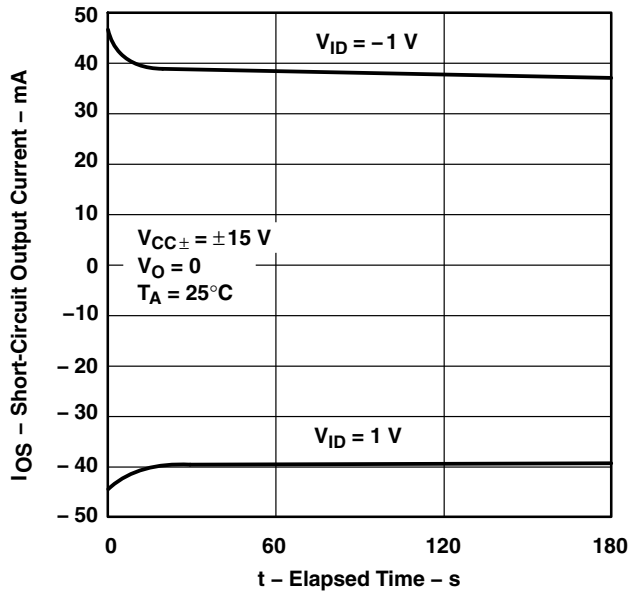

Figure 47

SHORT-CIRCUIT OUTPUT CURRENT†
vs
FREE-AIR TEMPERATURE

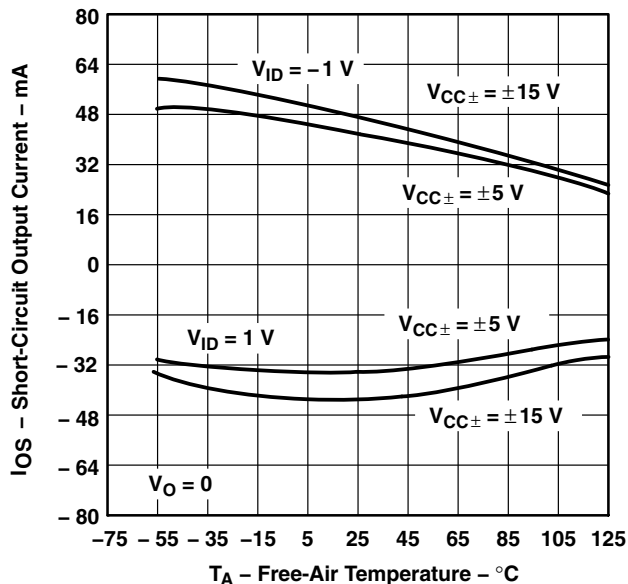

Figure 48

SLEW RATE†
vs
FREE-AIR TEMPERATURE

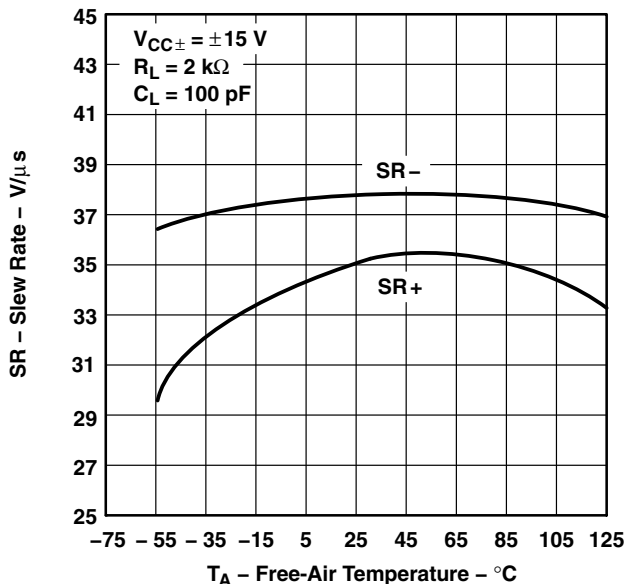

Figure 49

† Data at high and low temperatures are applicable only within the rated operating free-air temperature ranges of the various devices.



TYPICAL CHARACTERISTICS

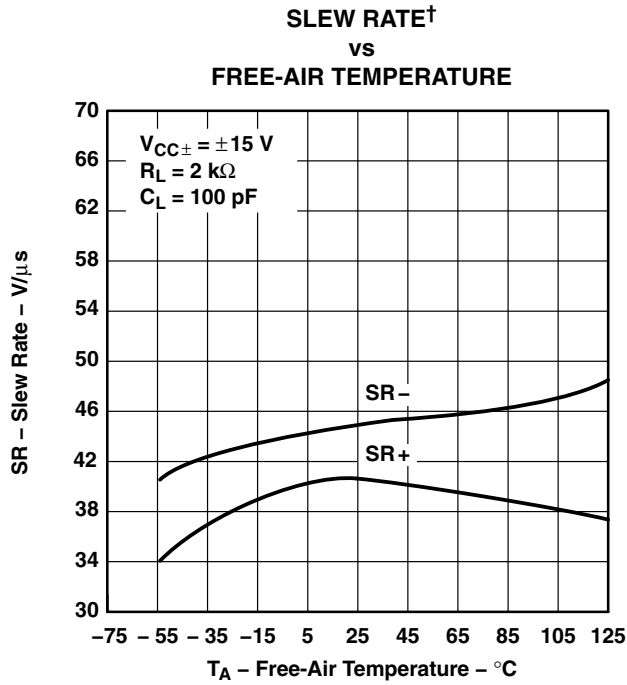

Figure 50

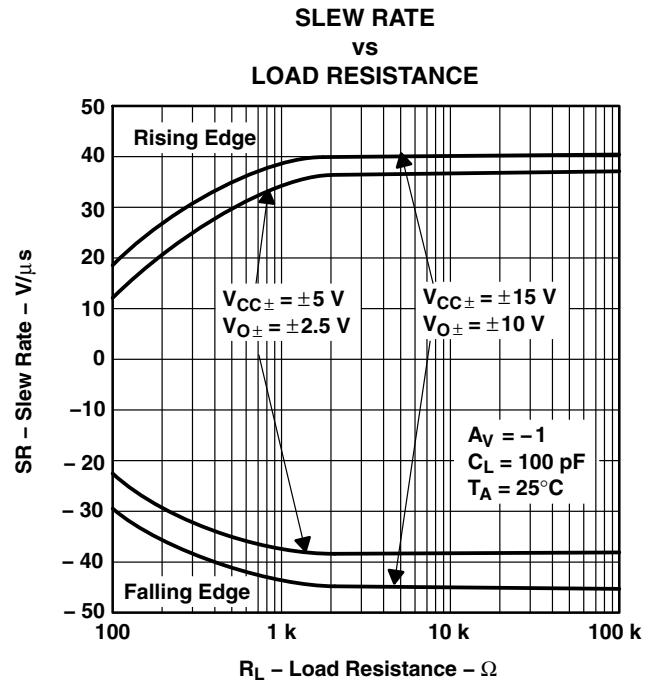

Figure 51

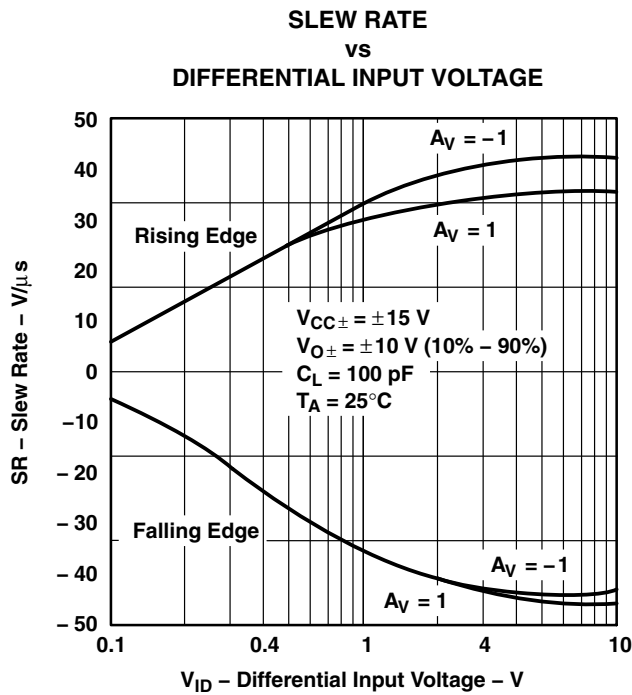

Figure 52

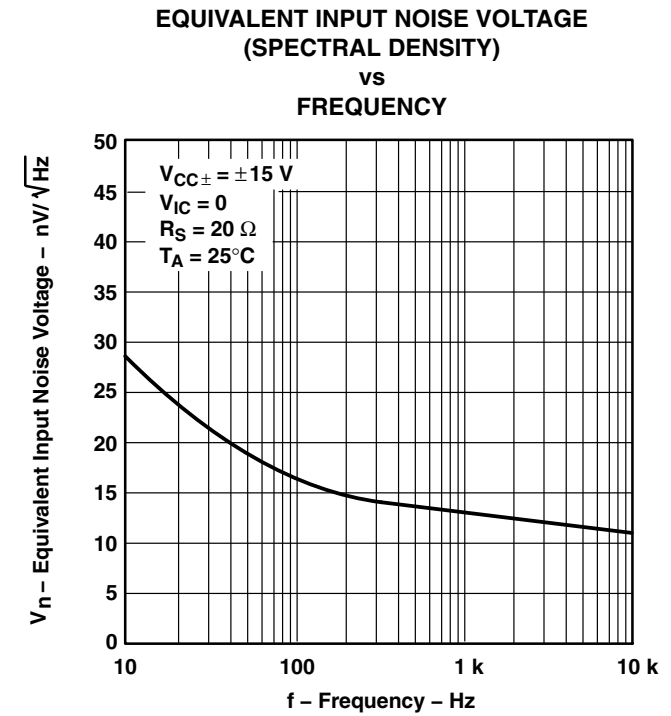

Figure 53

† Data at high and low temperatures are applicable only within the rated operating free-air temperature ranges of the various devices.

TLE207x, TLE207xA EXCALIBUR LOW-NOISE HIGH-SPEED JFET-INPUT OPERATIONAL AMPLIFIERS

SLOS181C – FEBRUARY 1997 – REVISED DECEMBER 2009

TYPICAL CHARACTERISTICS

INPUT-REFERRED NOISE VOLTAGE
vs
NOISE BANDWIDTH

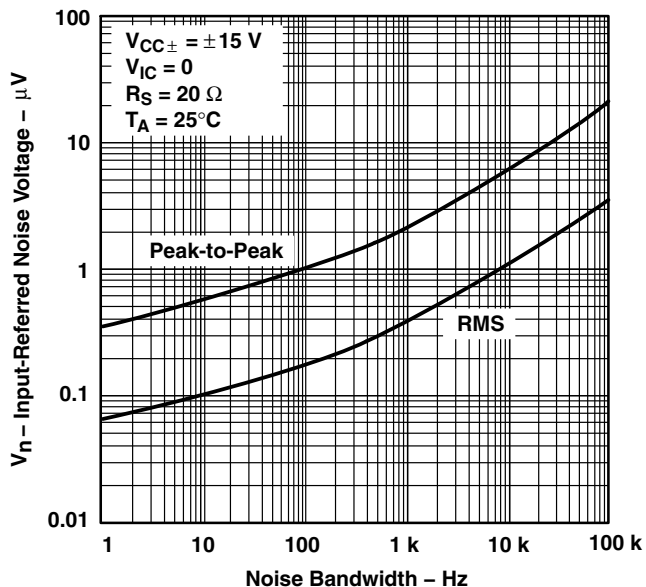

Figure 54

INPUT-REFERRED NOISE VOLTAGE
OVER A 10-SECOND TIME INTERVAL

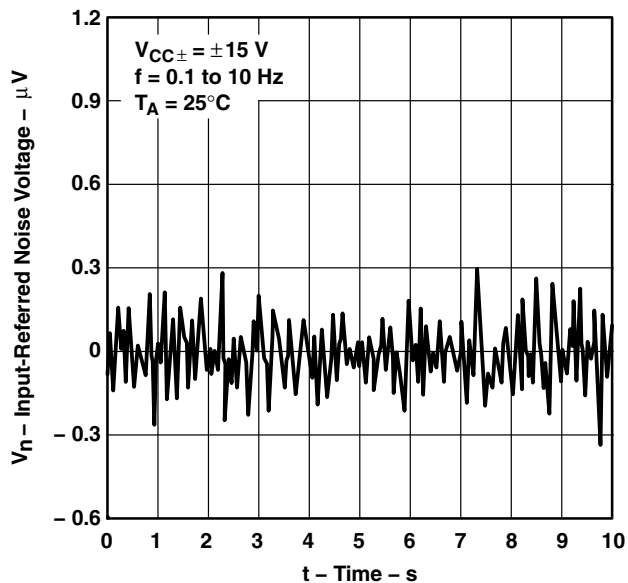

Figure 55

THIRD-OCTAVE SPECTRAL NOISE DENSITY
vs
FREQUENCY BANDS

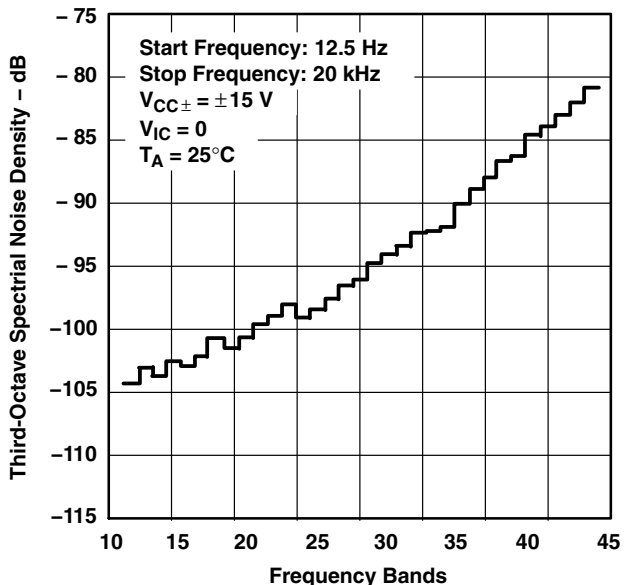

Figure 56

TOTAL HARMONIC DISTORTION PLUS NOISE
vs
FREQUENCY

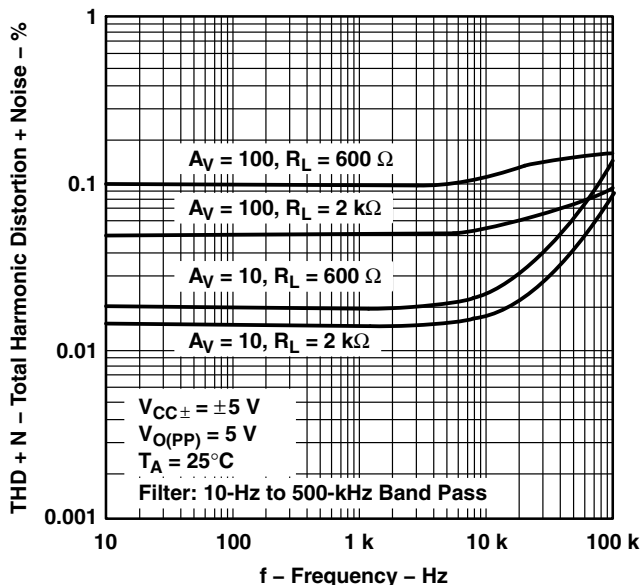

Figure 57

TYPICAL CHARACTERISTICS

**TOTAL HARMONIC DISTORTION PLUS NOISE
 vs
 FREQUENCY**

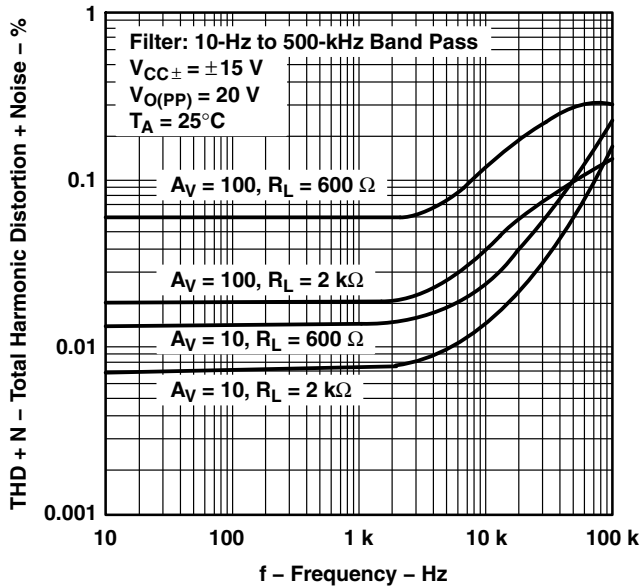

Figure 58

**UNITY-GAIN BANDWIDTH
 vs
 LOAD CAPACITANCE**

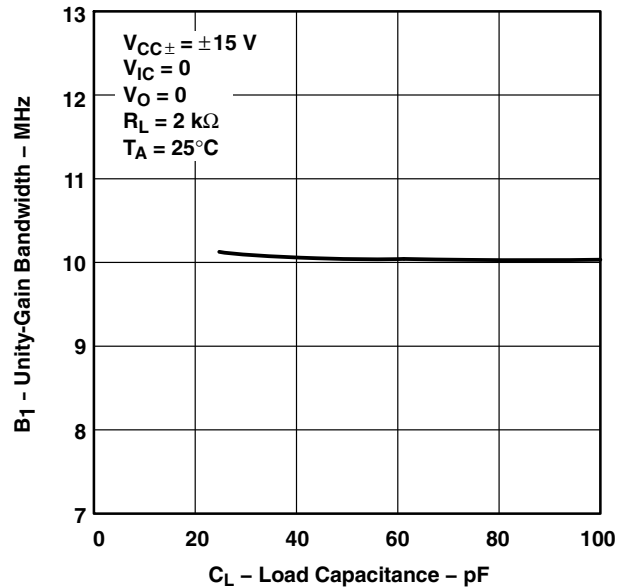

Figure 59

**GAIN-BANDWIDTH PRODUCT†
 vs
 FREE-AIR TEMPERATURE**

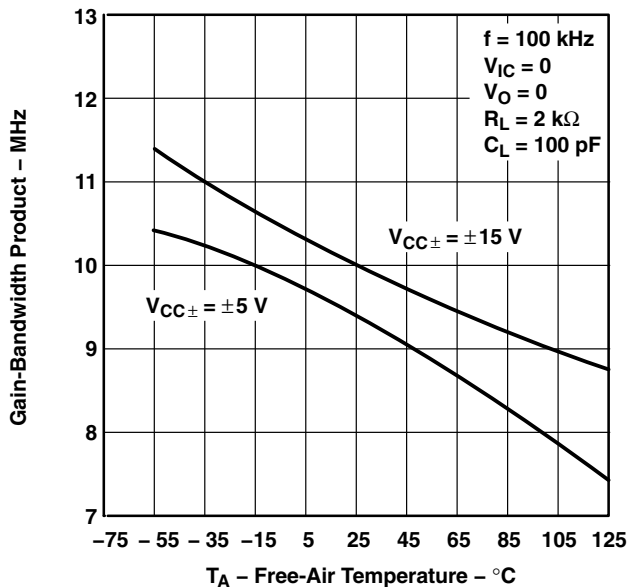

Figure 60

**GAIN-BANDWIDTH PRODUCT
 vs
 SUPPLY VOLTAGE**

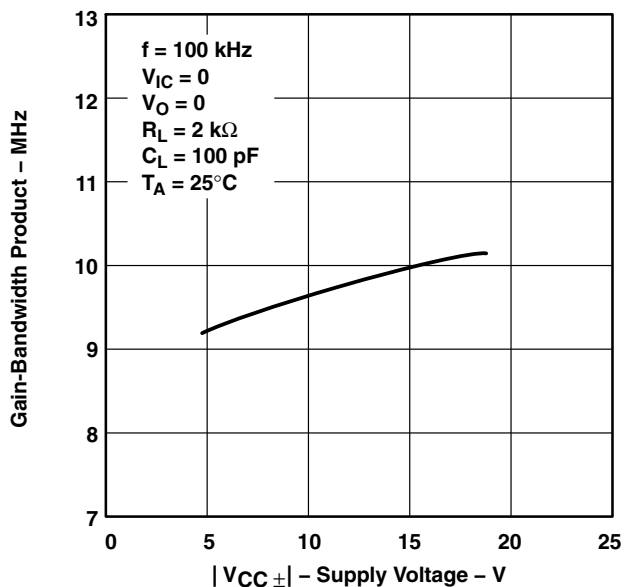

Figure 61

† Data at high and low temperatures are applicable only within the rated operating free-air temperature ranges of the various devices.

TLE207x, TLE207xA
EXCALIBUR LOW-NOISE HIGH-SPEED
JFET-INPUT OPERATIONAL AMPLIFIERS

SLOS181C – FEBRUARY 1997 – REVISED DECEMBER 2009

TYPICAL CHARACTERISTICS

GAIN MARGIN
vs
LOAD CAPACITANCE

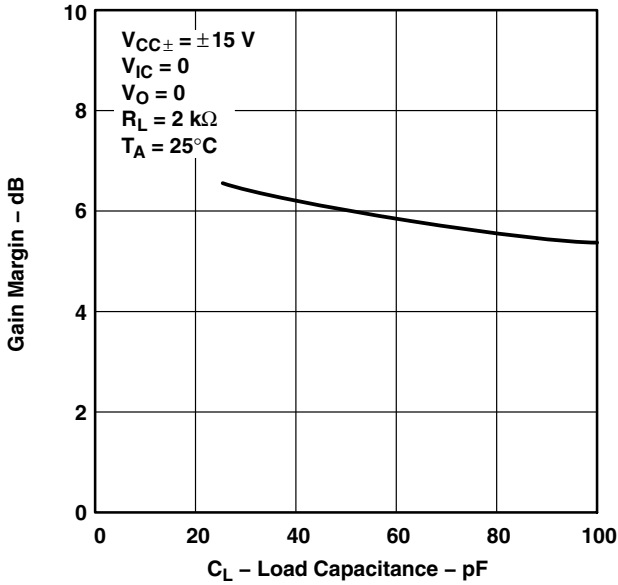

Figure 62

PHASE MARGIN†
vs
FREE-AIR TEMPERATURE

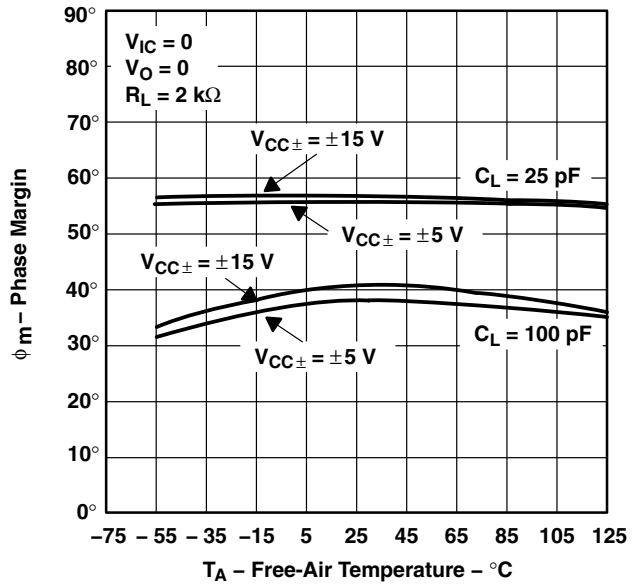

Figure 63

PHASE MARGIN
vs
SUPPLY VOLTAGE

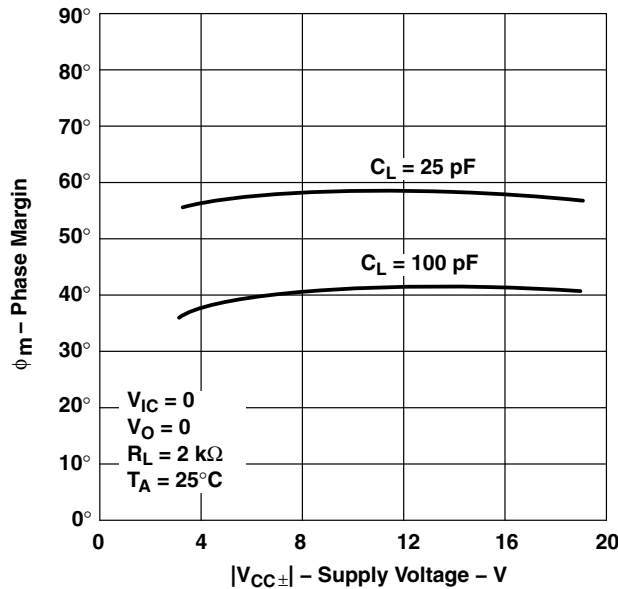

Figure 64

PHASE MARGIN
vs
LOAD CAPACITANCE

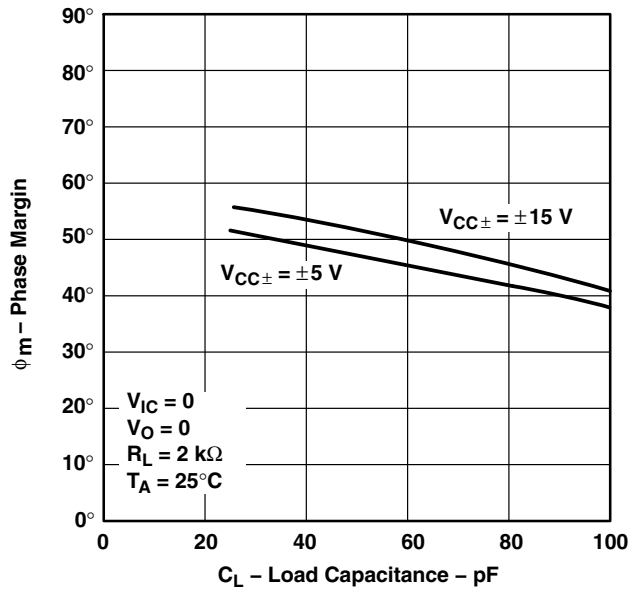

Figure 65

† Data at high and low temperatures are applicable only within the rated operating free-air temperature ranges of the various devices.

TYPICAL CHARACTERISTICS

**NONINVERTING LARGE-SIGNAL
 PULSE RESPONSE†**

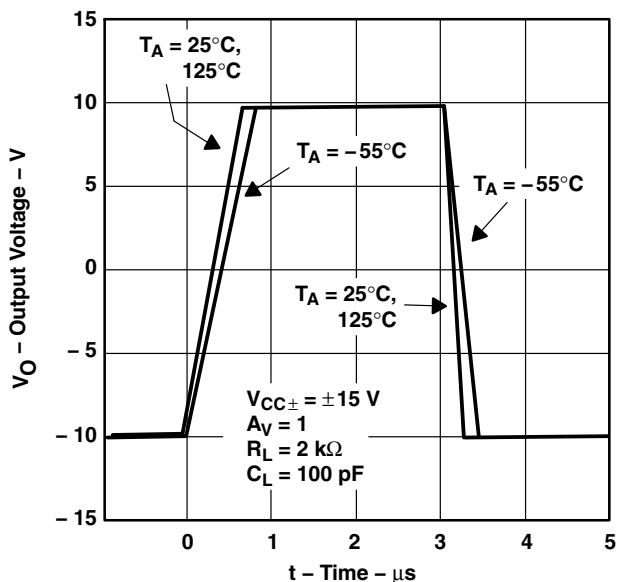

Figure 66

SMALL-SIGNAL PULSE RESPONSE

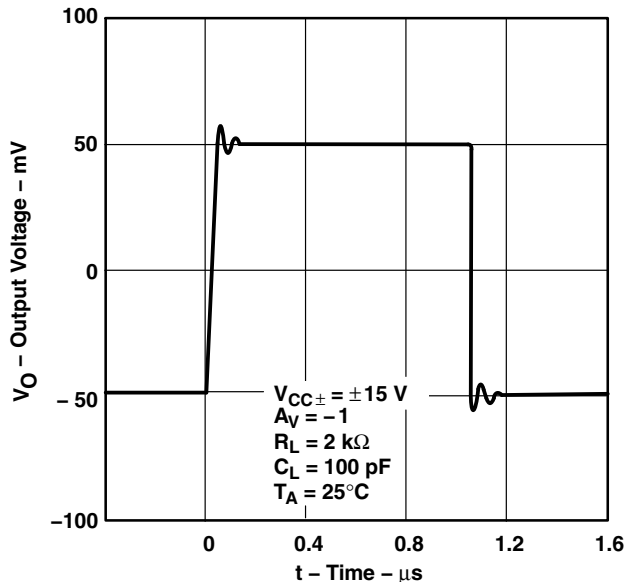

Figure 67

**CLOSED-LOOP OUTPUT IMPEDANCE
 vs
 FREQUENCY**

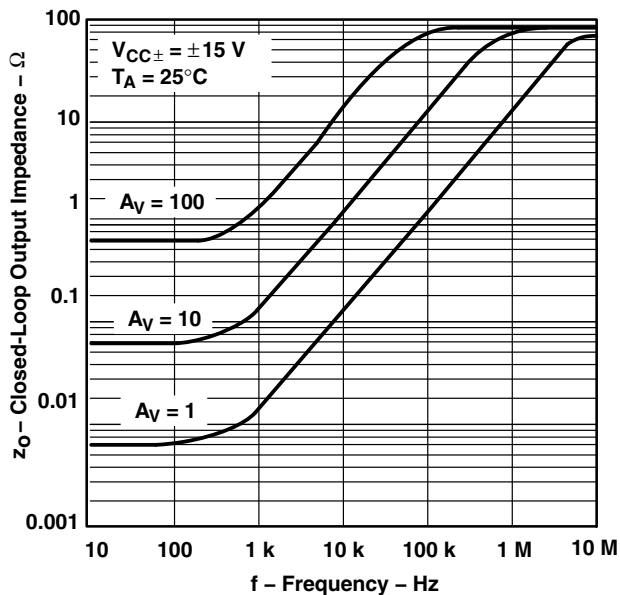

Figure 68

**TLE2072 AND TLE2074
 CROSSTALK ATTENUATION
 vs
 FREQUENCY**

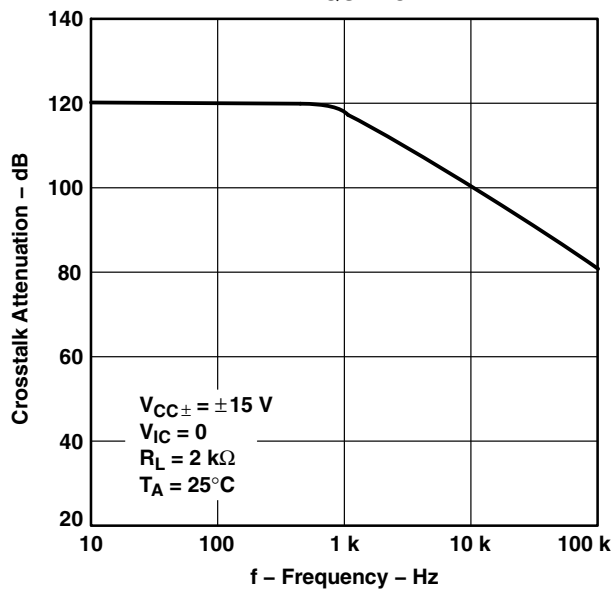

Figure 69

† Data at high and low temperatures are applicable only within the rated operating free-air temperature ranges of the various devices.

TLE207x, TLE207xA EXCALIBUR LOW-NOISE HIGH-SPEED JFET-INPUT OPERATIONAL AMPLIFIERS

SLOS181C – FEBRUARY 1997 – REVISED DECEMBER 2009

APPLICATION INFORMATION

input characteristics

The TLE207x, TLE207xA, and TLE207xB are specified with a minimum and a maximum input voltage that if exceeded at either input could cause the device to malfunction. Because of the extremely high input impedance and resulting low bias current requirements, the TLE207x, TLE207xA, and TLE207xB are well suited for low-level signal processing; however, leakage currents on printed-circuit boards and sockets can easily exceed bias current requirements and cause degradation in system performance. It is good practice to include guard rings around inputs (see Figure 70). These guards should be driven from a low-impedance source at the same voltage level as the common-mode input.

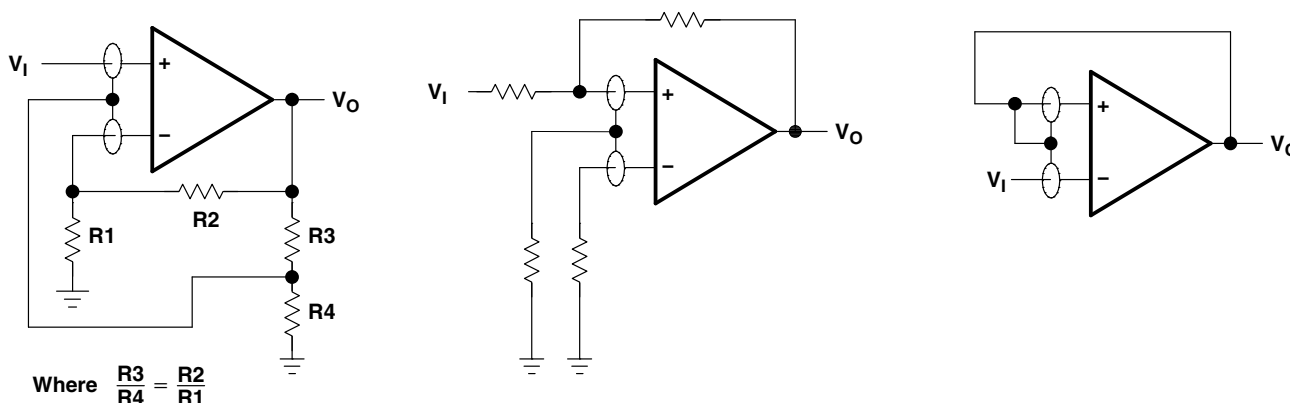

Figure 70. Use of Guard Rings

TLE2071 input offset voltage nulling

The TLE2071 series offers external null pins that can be used to further reduce the input offset voltage. The circuit of Figure 71 can be connected as shown if the feature is desired. When external nulling is not needed, the null pins may be left unconnected.

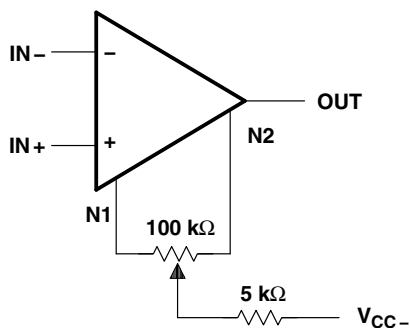

Figure 71. Input Offset Voltage Nulling

APPLICATION INFORMATION

macromodel information

Macromodel information provided was derived using *PSpice™ Parts™* model generation software. The Boyle macromodel (see Note 4) and subcircuit Figure 72 were generated using the TLE207x typical electrical and operating characteristics at $T_A = 25^\circ\text{C}$. Using this information, output simulations of the following key parameters can be generated to a tolerance of 20% (in most cases):

- Maximum positive output voltage swing
- Maximum negative output voltage swing
- Slew rate
- Quiescent power dissipation
- Input bias current
- Open-loop voltage amplification
- Unity-gain frequency
- Common-mode rejection ratio
- Phase margin
- DC output resistance
- AC output resistance
- Short-circuit output current limit

NOTE 4: G.R. Boyle, B.M. Cohn, D. O. Pederson, and J. E. Solomon, "Macromodeling of Integrated Circuit Operational Amplifiers", *IEEE Journal of Solid-State Circuits*, SC-9, 353 (1974).

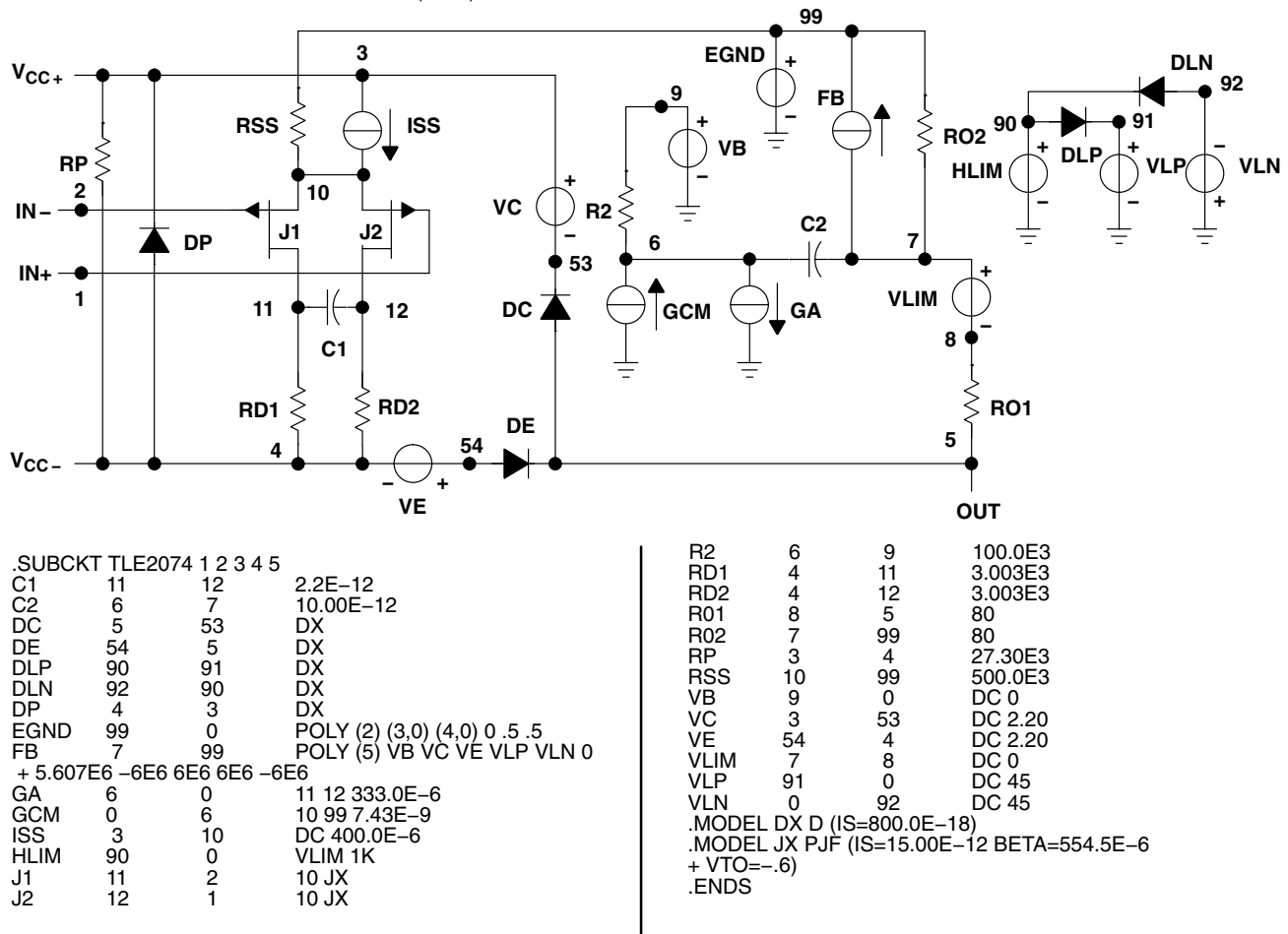

Figure 72. Boyle Macromodel and Subcircuit

PSpice and *Parts* are trademarks of MicroSim Corporation.

TLE207x, TLE207xA EXCALIBUR LOW-NOISE HIGH-SPEED JFET-INPUT OPERATIONAL AMPLIFIERS

SLOS181C – FEBRUARY 1997 – REVISED DECEMBER 2009

Revision History

| Version | Date | Changes |
|---------|----------|--------------------------------------------------------------------------------------------------------------------------------------------------------------------------------------------------------------------------------------------------------------------------------------------------------------------------------------------------------------------------------------------------------------------------------------------------------------------------------------------------------------------------------------------------------------------------------------------------------------------------------------------------------------------------------------------------------------------------------------------------------------------------------------------------------------------------------------------------------------------------------------------------------------------------------------------------------------|
| C | Dec-2009 | <ul style="list-style-type: none">– For TLE2071M/1AM (VCC ±5V) changed V_n NOM & MAX from 28/55 to 48/85 (f = 10 Hz); 11.6/17 to 12/17 (f = 10 KHz), Pg. 16– For TLE2071M/1AM (VCC ±15V) changed V_n NOM & MAX from 28/55 to 48/85 (f = 10 Hz); 11.6/17 to 12/17 (f = 10 KHz), Pg. 18– For TLE2072M/2AM (VCC ±5V) changed V_n NOM & MAX from 28/55 to 48/85 (f = 10 Hz); 11.6/17 to 12/17 (f = 10 KHz), Pg. 29– For TLE2072M/2AM (VCC ±15V) changed V_n NOM & MAX from 28/55 to 48/85 (f = 10 Hz); 11.6/17 to 12/17 (f = 10 KHz), Pg. 31– For TLE2074M/4AM (VCC ±5V) changed V_n NOM & MAX from 28/55 to 48/85 (f = 10 Hz); 11.6/17 to 12/17 (f = 10 KHz), Pg. 42– For TLE2074M/4AM (VCC ±15V) changed V_n NOM & MAX from 28/55 to 48/85 (f = 10 Hz); 11.6/17 to 12/17 (f = 10 KHz), Pg. 44 |



PACKAGING INFORMATION

| Orderable Device | Status (1) | Package Type | Package Drawing | Pins | Package Qty | Eco Plan (2) | Lead/Ball Finish (6) | MSL Peak Temp (3) | Op Temp (°C) | Device Marking (4/5) | Samples |
|------------------|---------------|--------------|--------------------|------|----------------|-----------------|-------------------------|----------------------|--------------|-----------------------------------------|-------------------------|
| 5962-9460201Q2A | ACTIVE | LCCC | FK | 20 | 1 | TBD | POST-PLATE | N / A for Pkg Type | -55 to 125 | 5962- 9460201Q2A TLE2071 MFKB | Samples |
| 5962-9460201QPA | ACTIVE | CDIP | JG | 8 | 1 | TBD | A42 | N / A for Pkg Type | -55 to 125 | 9460201QPA TLE2071M | Samples |
| 5962-9460202Q2A | ACTIVE | LCCC | FK | 20 | 1 | TBD | POST-PLATE | N / A for Pkg Type | -55 to 125 | 5962- 9460202Q2A TLE2072 MFKB | Samples |
| 5962-9460202QHA | ACTIVE | CFP | U | 10 | 1 | TBD | A42 | N / A for Pkg Type | -55 to 125 | 9460202QHA TLE2072M | Samples |
| 5962-9460202QPA | ACTIVE | CDIP | JG | 8 | 1 | TBD | A42 | N / A for Pkg Type | -55 to 125 | 9460202QPA TLE2072M | Samples |
| 5962-9460203Q2A | ACTIVE | LCCC | FK | 20 | 1 | TBD | POST-PLATE | N / A for Pkg Type | -55 to 125 | 5962- 9460203Q2A TLE2074 MFKB | Samples |
| 5962-9460203QCA | ACTIVE | CDIP | J | 14 | 1 | TBD | A42 | N / A for Pkg Type | -55 to 125 | 5962-9460203QC A TLE2074MJB | Samples |
| 5962-9460204Q2A | ACTIVE | LCCC | FK | 20 | 1 | TBD | POST-PLATE | N / A for Pkg Type | -55 to 125 | 5962 9460204Q2A TLE2071 AMFKB | Samples |
| 5962-9460204QHA | ACTIVE | CFP | U | 10 | 1 | TBD | A42 | N / A for Pkg Type | -55 to 125 | 9460204QHA TLE2071AM | Samples |
| 5962-9460204QPA | ACTIVE | CDIP | JG | 8 | 1 | TBD | A42 | N / A for Pkg Type | -55 to 125 | 9460204QPA TLE2071AM | Samples |
| 5962-9460205Q2A | ACTIVE | LCCC | FK | 20 | 1 | TBD | POST-PLATE | N / A for Pkg Type | -55 to 125 | 5962- 9460205Q2A TLE2072 AMFKB | Samples |
| 5962-9460205QHA | ACTIVE | CFP | U | 10 | 1 | TBD | A42 | N / A for Pkg Type | -55 to 125 | 9460205QHA TLE2072AM | Samples |

| Orderable Device | Status (1) | Package Type | Package Drawing | Pins | Package Qty | Eco Plan (2) | Lead/Ball Finish (6) | MSL Peak Temp (3) | Op Temp (°C) | Device Marking (4/5) | Samples |
|------------------|---------------|--------------|-----------------|------|-------------|----------------------------|-------------------------|----------------------|--------------|-----------------------------------------|-------------------------|
| 5962-9460205QPA | ACTIVE | CDIP | JG | 8 | 1 | TBD | A42 | N / A for Pkg Type | -55 to 125 | 9460205QPA TLE2072AM | Samples |
| 5962-9460206Q2A | ACTIVE | LCCC | FK | 20 | 1 | TBD | POST-PLATE | N / A for Pkg Type | -55 to 125 | 5962- 9460206Q2A TLE2074 AMFKB | Samples |
| 5962-9460206QCA | ACTIVE | CDIP | J | 14 | 1 | TBD | A42 | N / A for Pkg Type | -55 to 125 | 5962-9460206QC A TLE2074AMJB | Samples |
| 5962-9460206QDA | ACTIVE | CFP | W | 14 | 1 | TBD | A42 | N / A for Pkg Type | -55 to 125 | 5962-9460206QD A TLE2074AMWB | Samples |
| TLE2071ACD | ACTIVE | SOIC | D | 8 | 75 | Green (RoHS & no Sb/Br) | CU NIPDAU | Level-1-260C-UNLIM | | 2071AC | Samples |
| TLE2071ACDG4 | ACTIVE | SOIC | D | 8 | 75 | Green (RoHS & no Sb/Br) | CU NIPDAU | Level-1-260C-UNLIM | | 2071AC | Samples |
| TLE2071ACDR | ACTIVE | SOIC | D | 8 | 2500 | Green (RoHS & no Sb/Br) | CU NIPDAU | Level-1-260C-UNLIM | | 2071AC | Samples |
| TLE2071ACP | ACTIVE | PDIP | P | 8 | 50 | Pb-Free (RoHS) | CU NIPDAU | N / A for Pkg Type | | TLE2071AC | Samples |
| TLE2071ACPE4 | ACTIVE | PDIP | P | 8 | 50 | Pb-Free (RoHS) | CU NIPDAU | N / A for Pkg Type | | TLE2071AC | Samples |
| TLE2071AID | ACTIVE | SOIC | D | 8 | 75 | Green (RoHS & no Sb/Br) | CU NIPDAU | Level-1-260C-UNLIM | | 2071AI | Samples |
| TLE2071AIDG4 | ACTIVE | SOIC | D | 8 | 75 | Green (RoHS & no Sb/Br) | CU NIPDAU | Level-1-260C-UNLIM | | 2071AI | Samples |
| TLE2071AIDR | ACTIVE | SOIC | D | 8 | 2500 | Green (RoHS & no Sb/Br) | CU NIPDAU | Level-1-260C-UNLIM | | 2071AI | Samples |
| TLE2071AIDRG4 | ACTIVE | SOIC | D | 8 | 2500 | Green (RoHS & no Sb/Br) | CU NIPDAU | Level-1-260C-UNLIM | | 2071AI | Samples |
| TLE2071AIP | ACTIVE | PDIP | P | 8 | 50 | Pb-Free (RoHS) | CU NIPDAU | N / A for Pkg Type | | TLE2071AI | Samples |
| TLE2071AMFKB | ACTIVE | LCCC | FK | 20 | 1 | TBD | POST-PLATE | N / A for Pkg Type | -55 to 125 | 5962 9460204Q2A TLE2071 AMFKB | Samples |

| Orderable Device | Status (1) | Package Type | Package Drawing | Pins | Package Qty | Eco Plan (2) | Lead/Ball Finish (6) | MSL Peak Temp (3) | Op Temp (°C) | Device Marking (4/5) | Samples |
|------------------|---------------|--------------|-----------------|------|-------------|----------------------------|-------------------------|----------------------|--------------|----------------------------------------|-------------------------|
| TLE2071AMJG | ACTIVE | CDIP | JG | 8 | 1 | TBD | A42 | N / A for Pkg Type | -55 to 125 | TLE2071 AMJG | Samples |
| TLE2071AMJGB | ACTIVE | CDIP | JG | 8 | 1 | TBD | A42 | N / A for Pkg Type | -55 to 125 | 9460204QPA TLE2071AM | Samples |
| TLE2071AMUB | ACTIVE | CFP | U | 10 | 1 | TBD | A42 | N / A for Pkg Type | -55 to 125 | 9460204QHA TLE2071AM | Samples |
| TLE2071CD | ACTIVE | SOIC | D | 8 | 75 | Green (RoHS & no Sb/Br) | CU NIPDAU | Level-1-260C-UNLIM | | 2071C | Samples |
| TLE2071CDG4 | ACTIVE | SOIC | D | 8 | 75 | Green (RoHS & no Sb/Br) | CU NIPDAU | Level-1-260C-UNLIM | | 2071C | Samples |
| TLE2071CDR | OBSOLETE | SOIC | D | 8 | | TBD | Call TI | Call TI | | | |
| TLE2071CP | ACTIVE | PDIP | P | 8 | 50 | Pb-Free (RoHS) | CU NIPDAU | N / A for Pkg Type | | TLE2071CP | Samples |
| TLE2071CPE4 | ACTIVE | PDIP | P | 8 | 50 | Pb-Free (RoHS) | CU NIPDAU | N / A for Pkg Type | | TLE2071CP | Samples |
| TLE2071ID | ACTIVE | SOIC | D | 8 | 75 | Green (RoHS & no Sb/Br) | CU NIPDAU | Level-1-260C-UNLIM | | 2071I | Samples |
| TLE2071IDG4 | ACTIVE | SOIC | D | 8 | 75 | Green (RoHS & no Sb/Br) | CU NIPDAU | Level-1-260C-UNLIM | | 2071I | Samples |
| TLE2071IDR | ACTIVE | SOIC | D | 8 | 2500 | Green (RoHS & no Sb/Br) | CU NIPDAU | Level-1-260C-UNLIM | | 2071I | Samples |
| TLE2071IDRG4 | ACTIVE | SOIC | D | 8 | 2500 | Green (RoHS & no Sb/Br) | CU NIPDAU | Level-1-260C-UNLIM | | 2071I | Samples |
| TLE2071IP | ACTIVE | PDIP | P | 8 | 50 | Pb-Free (RoHS) | CU NIPDAU | N / A for Pkg Type | | TLE2071IP | Samples |
| TLE2071MFKB | ACTIVE | LCCC | FK | 20 | 1 | TBD | POST-PLATE | N / A for Pkg Type | -55 to 125 | 5962- 9460201Q2A TLE2071 MFKB | Samples |
| TLE2071MJG | ACTIVE | CDIP | JG | 8 | 1 | TBD | A42 | N / A for Pkg Type | -55 to 125 | TLE2071MJG | Samples |
| TLE2071MJGB | ACTIVE | CDIP | JG | 8 | 1 | TBD | A42 | N / A for Pkg Type | -55 to 125 | 9460201QPA TLE2071M | Samples |
| TLE2072ACD | ACTIVE | SOIC | D | 8 | 75 | Green (RoHS & no Sb/Br) | CU NIPDAU | Level-1-260C-UNLIM | | 2072AC | Samples |
| TLE2072ACDG4 | ACTIVE | SOIC | D | 8 | 75 | Green (RoHS & no Sb/Br) | CU NIPDAU | Level-1-260C-UNLIM | | 2072AC | Samples |

| Orderable Device | Status (1) | Package Type | Package Drawing | Pins | Package Qty | Eco Plan (2) | Lead/Ball Finish (6) | MSL Peak Temp (3) | Op Temp (°C) | Device Marking (4/5) | Samples |
|------------------|---------------|--------------|--------------------|------|----------------|----------------------------|-------------------------|----------------------|--------------|-----------------------------------------|-------------------------|
| TLE2072ACP | ACTIVE | PDIP | P | 8 | 50 | Pb-Free (RoHS) | CU NIPDAU | N / A for Pkg Type | | TLE2072AC | Samples |
| TLE2072ACPE4 | ACTIVE | PDIP | P | 8 | 50 | Pb-Free (RoHS) | CU NIPDAU | N / A for Pkg Type | | TLE2072AC | Samples |
| TLE2072AID | ACTIVE | SOIC | D | 8 | 75 | Green (RoHS & no Sb/Br) | CU NIPDAU | Level-1-260C-UNLIM | | 2072AI | Samples |
| TLE2072AIDG4 | ACTIVE | SOIC | D | 8 | 75 | Green (RoHS & no Sb/Br) | CU NIPDAU | Level-1-260C-UNLIM | | 2072AI | Samples |
| TLE2072AIDR | ACTIVE | SOIC | D | 8 | 2500 | Green (RoHS & no Sb/Br) | CU NIPDAU | Level-1-260C-UNLIM | | 2072AI | Samples |
| TLE2072AIDRG4 | ACTIVE | SOIC | D | 8 | 2500 | Green (RoHS & no Sb/Br) | CU NIPDAU | Level-1-260C-UNLIM | | 2072AI | Samples |
| TLE2072AIP | ACTIVE | PDIP | P | 8 | 50 | Pb-Free (RoHS) | CU NIPDAU | N / A for Pkg Type | | TLE2072AI | Samples |
| TLE2072AIPE4 | ACTIVE | PDIP | P | 8 | 50 | Pb-Free (RoHS) | CU NIPDAU | N / A for Pkg Type | | TLE2072AI | Samples |
| TLE2072AMFKB | ACTIVE | LCCC | FK | 20 | 1 | TBD | POST-PLATE | N / A for Pkg Type | -55 to 125 | 5962- 9460205Q2A TLE2072 AMFKB | Samples |
| TLE2072AMJG | ACTIVE | CDIP | JG | 8 | 1 | TBD | A42 | N / A for Pkg Type | -55 to 125 | TLE2072 AMJG | Samples |
| TLE2072AMJGB | ACTIVE | CDIP | JG | 8 | 1 | TBD | A42 | N / A for Pkg Type | -55 to 125 | 9460205QPA TLE2072AM | Samples |
| TLE2072AMUB | ACTIVE | CFP | U | 10 | 1 | TBD | A42 | N / A for Pkg Type | -55 to 125 | 9460205QHA TLE2072AM | Samples |
| TLE2072CD | ACTIVE | SOIC | D | 8 | 75 | Green (RoHS & no Sb/Br) | CU NIPDAU | Level-1-260C-UNLIM | | 2072C | Samples |
| TLE2072CDG4 | ACTIVE | SOIC | D | 8 | 75 | Green (RoHS & no Sb/Br) | CU NIPDAU | Level-1-260C-UNLIM | | 2072C | Samples |
| TLE2072CDR | ACTIVE | SOIC | D | 8 | 2500 | Green (RoHS & no Sb/Br) | CU NIPDAU | Level-1-260C-UNLIM | | 2072C | Samples |
| TLE2072CDRG4 | ACTIVE | SOIC | D | 8 | 2500 | Green (RoHS & no Sb/Br) | CU NIPDAU | Level-1-260C-UNLIM | | 2072C | Samples |
| TLE2072CP | ACTIVE | PDIP | P | 8 | 50 | Pb-Free (RoHS) | CU NIPDAU | N / A for Pkg Type | | TLE2072CP | Samples |

| Orderable Device | Status (1) | Package Type | Package Drawing | Pins | Package Qty | Eco Plan (2) | Lead/Ball Finish (6) | MSL Peak Temp (3) | Op Temp (°C) | Device Marking (4/5) | Samples |
|------------------|---------------|--------------|--------------------|------|----------------|----------------------------|-------------------------|----------------------|--------------|----------------------------------------|-------------------------|
| TLE2072ID | ACTIVE | SOIC | D | 8 | 75 | Green (RoHS & no Sb/Br) | CU NIPDAU | Level-1-260C-UNLIM | | 2072I | Samples |
| TLE2072IDG4 | ACTIVE | SOIC | D | 8 | 75 | Green (RoHS & no Sb/Br) | CU NIPDAU | Level-1-260C-UNLIM | | 2072I | Samples |
| TLE2072IDR | ACTIVE | SOIC | D | 8 | 2500 | Green (RoHS & no Sb/Br) | CU NIPDAU | Level-1-260C-UNLIM | -40 to 85 | 2072I | Samples |
| TLE2072IDRG4 | ACTIVE | SOIC | D | 8 | 2500 | Green (RoHS & no Sb/Br) | CU NIPDAU | Level-1-260C-UNLIM | -40 to 85 | 2072I | Samples |
| TLE2072IP | ACTIVE | PDIP | P | 8 | 50 | Pb-Free (RoHS) | CU NIPDAU | N / A for Pkg Type | | TLE2072IP | Samples |
| TLE2072IPE4 | ACTIVE | PDIP | P | 8 | 50 | Pb-Free (RoHS) | CU NIPDAU | N / A for Pkg Type | | TLE2072IP | Samples |
| TLE2072MFKB | ACTIVE | LCCC | FK | 20 | 1 | TBD | POST-PLATE | N / A for Pkg Type | -55 to 125 | 5962- 9460202Q2A TLE2072 MFKB | Samples |
| TLE2072MJG | ACTIVE | CDIP | JG | 8 | 1 | TBD | A42 | N / A for Pkg Type | -55 to 125 | TLE2072MJG | Samples |
| TLE2072MJGB | ACTIVE | CDIP | JG | 8 | 1 | TBD | A42 | N / A for Pkg Type | -55 to 125 | 9460202QPA TLE2072M | Samples |
| TLE2072MUB | ACTIVE | CFP | U | 10 | 1 | TBD | A42 | N / A for Pkg Type | -55 to 125 | 9460202QHA TLE2072M | Samples |
| TLE2074ACDW | ACTIVE | SOIC | DW | 16 | 40 | Green (RoHS & no Sb/Br) | CU NIPDAU | Level-1-260C-UNLIM | | TLE2074AC | Samples |
| TLE2074ACDWG4 | ACTIVE | SOIC | DW | 16 | 40 | Green (RoHS & no Sb/Br) | CU NIPDAU | Level-1-260C-UNLIM | | TLE2074AC | Samples |
| TLE2074ACDWR | OBSOLETE | SOIC | DW | 16 | | TBD | Call TI | Call TI | | | |
| TLE2074ACN | ACTIVE | PDIP | N | 14 | 25 | Pb-Free (RoHS) | CU NIPDAU | N / A for Pkg Type | | TLE2074ACN | Samples |
| TLE2074ACNE4 | ACTIVE | PDIP | N | 14 | 25 | Pb-Free (RoHS) | CU NIPDAU | N / A for Pkg Type | | TLE2074ACN | Samples |
| TLE2074AIDW | ACTIVE | SOIC | DW | 16 | 40 | Green (RoHS & no Sb/Br) | CU NIPDAU | Level-1-260C-UNLIM | | TLE2074AI | Samples |
| TLE2074AIDWG4 | ACTIVE | SOIC | DW | 16 | 40 | Green (RoHS & no Sb/Br) | CU NIPDAU | Level-1-260C-UNLIM | | TLE2074AI | Samples |
| TLE2074AIDWR | OBSOLETE | SOIC | DW | 16 | | TBD | Call TI | Call TI | | | |

| Orderable Device | Status (1) | Package Type | Package Drawing | Pins | Package Qty | Eco Plan (2) | Lead/Ball Finish (6) | MSL Peak Temp (3) | Op Temp (°C) | Device Marking (4/5) | Samples |
|------------------|---------------|--------------|-----------------|------|-------------|-------------------------|-------------------------|----------------------|--------------|-------------------------------------|-------------------------|
| TLE2074AIN | ACTIVE | PDIP | N | 14 | 25 | Pb-Free (RoHS) | CU NIPDAU | N / A for Pkg Type | | TLE2074AIN | Samples |
| TLE2074AINE4 | ACTIVE | PDIP | N | 14 | 25 | Pb-Free (RoHS) | CU NIPDAU | N / A for Pkg Type | | TLE2074AIN | Samples |
| TLE2074AMFKB | ACTIVE | LCCC | FK | 20 | 1 | TBD | POST-PLATE | N / A for Pkg Type | -55 to 125 | 5962-9460206Q2A TLE2074 AMFKB | Samples |
| TLE2074AMJ | ACTIVE | CDIP | J | 14 | 1 | TBD | A42 | N / A for Pkg Type | -55 to 125 | TLE2074AMJ | Samples |
| TLE2074AMJB | ACTIVE | CDIP | J | 14 | 1 | TBD | A42 | N / A for Pkg Type | -55 to 125 | 5962-9460206QC A TLE2074AMJB | Samples |
| TLE2074AMWB | ACTIVE | CFP | W | 14 | 1 | TBD | A42 | N / A for Pkg Type | -55 to 125 | 5962-9460206QD A TLE2074AMWB | Samples |
| TLE2074CDW | ACTIVE | SOIC | DW | 16 | 40 | Green (RoHS & no Sb/Br) | CU NIPDAU | Level-1-260C-UNLIM | | TLE2074C | Samples |
| TLE2074CDWG4 | ACTIVE | SOIC | DW | 16 | 40 | Green (RoHS & no Sb/Br) | CU NIPDAU | Level-1-260C-UNLIM | | TLE2074C | Samples |
| TLE2074CDWR | ACTIVE | SOIC | DW | 16 | 2000 | Green (RoHS & no Sb/Br) | CU NIPDAU | Level-1-260C-UNLIM | | TLE2074C | Samples |
| TLE2074CDWRG4 | ACTIVE | SOIC | DW | 16 | | TBD | Call TI | Call TI | | | Samples |
| TLE2074CN | ACTIVE | PDIP | N | 14 | 25 | Pb-Free (RoHS) | CU NIPDAU | N / A for Pkg Type | | TLE2074CN | Samples |
| TLE2074CNE4 | ACTIVE | PDIP | N | 14 | 25 | Pb-Free (RoHS) | CU NIPDAU | N / A for Pkg Type | | TLE2074CN | Samples |
| TLE2074IDW | ACTIVE | SOIC | DW | 16 | 40 | Green (RoHS & no Sb/Br) | CU NIPDAU | Level-1-260C-UNLIM | | TLE2074I | Samples |
| TLE2074IDWG4 | ACTIVE | SOIC | DW | 16 | 40 | Green (RoHS & no Sb/Br) | CU NIPDAU | Level-1-260C-UNLIM | | TLE2074I | Samples |
| TLE2074IDWR | ACTIVE | SOIC | DW | 16 | 2000 | Green (RoHS & no Sb/Br) | CU NIPDAU | Level-1-260C-UNLIM | | TLE2074I | Samples |
| TLE2074IN | ACTIVE | PDIP | N | 14 | 25 | Pb-Free (RoHS) | CU NIPDAU | N / A for Pkg Type | | TLE2074IN | Samples |

| Orderable Device | Status (1) | Package Type | Package Drawing | Pins | Package Qty | Eco Plan (2) | Lead/Ball Finish (6) | MSL Peak Temp (3) | Op Temp (°C) | Device Marking (4/5) | Samples |
|------------------|---------------|--------------|-----------------|------|-------------|-----------------|-------------------------|----------------------|--------------|------------------------------------|-------------------------|
| TLE2074INE4 | ACTIVE | PDIP | N | 14 | 25 | Pb-Free (RoHS) | CU NIPDAU | N / A for Pkg Type | | TLE2074IN | Samples |
| TLE2074MFKB | ACTIVE | LCCC | FK | 20 | 1 | TBD | POST-PLATE | N / A for Pkg Type | -55 to 125 | 5962-9460203Q2A TLE2074 MFKB | Samples |
| TLE2074MJ | ACTIVE | CDIP | J | 14 | 1 | TBD | A42 | N / A for Pkg Type | -55 to 125 | TLE2074MJ | Samples |
| TLE2074MJB | ACTIVE | CDIP | J | 14 | 1 | TBD | A42 | N / A for Pkg Type | -55 to 125 | 5962-9460203QC A TLE2074MJB | Samples |

(1) The marketing status values are defined as follows:

ACTIVE: Product device recommended for new designs.

LIFEBUY: TI has announced that the device will be discontinued, and a lifetime-buy period is in effect.

NRND: Not recommended for new designs. Device is in production to support existing customers, but TI does not recommend using this part in a new design.

PREVIEW: Device has been announced but is not in production. Samples may or may not be available.

OBSOLETE: TI has discontinued the production of the device.

(2) Eco Plan - The planned eco-friendly classification: Pb-Free (RoHS), Pb-Free (RoHS Exempt), or Green (RoHS & no Sb/Br) - please check <http://www.ti.com/productcontent> for the latest availability information and additional product content details.

TBD: The Pb-Free/Green conversion plan has not been defined.

Pb-Free (RoHS): TI's terms "Lead-Free" or "Pb-Free" mean semiconductor products that are compatible with the current RoHS requirements for all 6 substances, including the requirement that lead not exceed 0.1% by weight in homogeneous materials. Where designed to be soldered at high temperatures, TI Pb-Free products are suitable for use in specified lead-free processes.

Pb-Free (RoHS Exempt): This component has a RoHS exemption for either 1) lead-based flip-chip solder bumps used between the die and package, or 2) lead-based die adhesive used between the die and leadframe. The component is otherwise considered Pb-Free (RoHS compatible) as defined above.

Green (RoHS & no Sb/Br): TI defines "Green" to mean Pb-Free (RoHS compatible), and free of Bromine (Br) and Antimony (Sb) based flame retardants (Br or Sb do not exceed 0.1% by weight in homogeneous material)

(3) MSL, Peak Temp. - The Moisture Sensitivity Level rating according to the JEDEC industry standard classifications, and peak solder temperature.

(4) There may be additional marking, which relates to the logo, the lot trace code information, or the environmental category on the device.

(5) Multiple Device Markings will be inside parentheses. Only one Device Marking contained in parentheses and separated by a "~" will appear on a device. If a line is indented then it is a continuation of the previous line and the two combined represent the entire Device Marking for that device.

(6) Lead/Ball Finish - Orderable Devices may have multiple material finish options. Finish options are separated by a vertical ruled line. Lead/Ball Finish values may wrap to two lines if the finish value exceeds the maximum column width.

Important Information and Disclaimer: The information provided on this page represents TI's knowledge and belief as of the date that it is provided. TI bases its knowledge and belief on information provided by third parties, and makes no representation or warranty as to the accuracy of such information. Efforts are underway to better integrate information from third parties. TI has taken and continues to take reasonable steps to provide representative and accurate information but may not have conducted destructive testing or chemical analysis on incoming materials and chemicals. TI and TI suppliers consider certain information to be proprietary, and thus CAS numbers and other limited information may not be available for release.

In no event shall TI's liability arising out of such information exceed the total purchase price of the TI part(s) at issue in this document sold by TI to Customer on an annual basis.

OTHER QUALIFIED VERSIONS OF TLE2071, TLE2071A, TLE2071AM, TLE2071M, TLE2072, TLE2072A, TLE2072AM, TLE2072M, TLE2074, TLE2074A, TLE2074AM, TLE2074M :

- Catalog: [TLE2071A](#), [TLE2071](#), [TLE2072A](#), [TLE2072](#), [TLE2074A](#), [TLE2074](#)
- Automotive: [TLE2071-Q1](#), [TLE2071A-Q1](#), [TLE2071A-Q1](#), [TLE2071-Q1](#), [TLE2072A-Q1](#), [TLE2072A-Q1](#)
- Military: [TLE2071M](#), [TLE2071AM](#), [TLE2072M](#), [TLE2072AM](#), [TLE2074M](#), [TLE2074AM](#)

NOTE: Qualified Version Definitions:

- Catalog - TI's standard catalog product
- Automotive - Q100 devices qualified for high-reliability automotive applications targeting zero defects
- Military - QML certified for Military and Defense Applications

TAPE AND REEL INFORMATION

QUADRANT ASSIGNMENTS FOR PIN 1 ORIENTATION IN TAPE

*All dimensions are nominal

| Device | Package Type | Package Drawing | Pins | SPQ | Reel Diameter (mm) | Reel Width W1 (mm) | A0 (mm) | B0 (mm) | K0 (mm) | P1 (mm) | W (mm) | Pin1 Quadrant |
|-------------|--------------|-----------------|------|------|--------------------|--------------------|---------|---------|---------|---------|--------|---------------|
| TLE2071ACDR | SOIC | D | 8 | 2500 | 330.0 | 12.4 | 6.4 | 5.2 | 2.1 | 8.0 | 12.0 | Q1 |
| TLE2071AIDR | SOIC | D | 8 | 2500 | 330.0 | 12.4 | 6.4 | 5.2 | 2.1 | 8.0 | 12.0 | Q1 |
| TLE2071IDR | SOIC | D | 8 | 2500 | 330.0 | 12.4 | 6.4 | 5.2 | 2.1 | 8.0 | 12.0 | Q1 |
| TLE2072AIDR | SOIC | D | 8 | 2500 | 330.0 | 12.4 | 6.4 | 5.2 | 2.1 | 8.0 | 12.0 | Q1 |
| TLE2072CDR | SOIC | D | 8 | 2500 | 330.0 | 12.4 | 6.4 | 5.2 | 2.1 | 8.0 | 12.0 | Q1 |
| TLE2072IDR | SOIC | D | 8 | 2500 | 330.0 | 12.4 | 6.4 | 5.2 | 2.1 | 8.0 | 12.0 | Q1 |
| TLE2072IDR | SOIC | D | 8 | 2500 | 330.0 | 12.4 | 6.4 | 5.2 | 2.1 | 8.0 | 12.0 | Q1 |
| TLE2072IDR | SOIC | D | 8 | 2500 | 330.0 | 12.4 | 6.4 | 5.2 | 2.1 | 8.0 | 12.0 | Q1 |
| TLE2074CDWR | SOIC | DW | 16 | 2000 | 330.0 | 16.4 | 10.75 | 10.7 | 2.7 | 12.0 | 16.0 | Q1 |
| TLE2074IDWR | SOIC | DW | 16 | 2000 | 330.0 | 16.4 | 10.75 | 10.7 | 2.7 | 12.0 | 16.0 | Q1 |

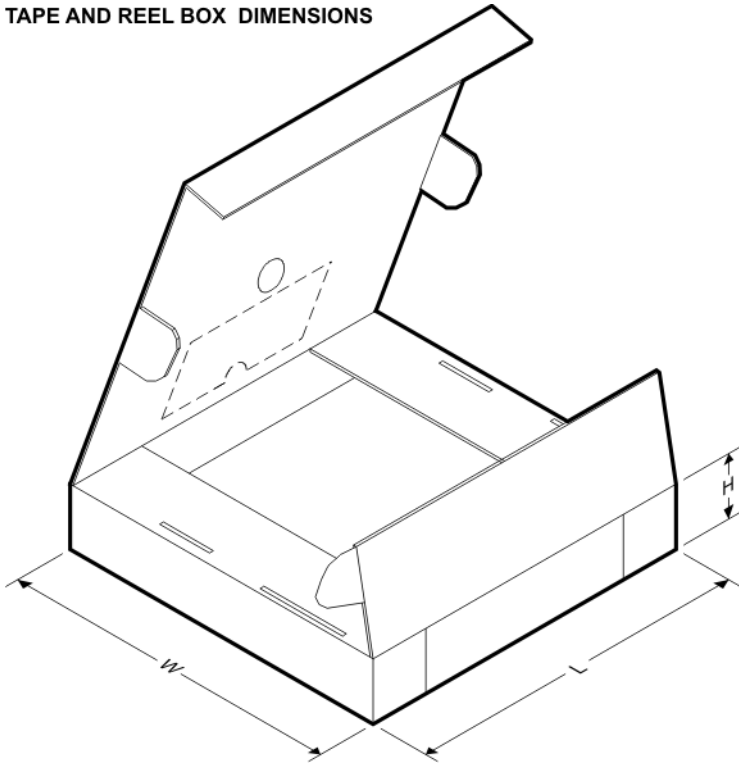
TAPE AND REEL BOX DIMENSIONS

*All dimensions are nominal

| Device | Package Type | Package Drawing | Pins | SPQ | Length (mm) | Width (mm) | Height (mm) |
|-------------|--------------|-----------------|------|------|-------------|------------|-------------|
| TLE2071ACDR | SOIC | D | 8 | 2500 | 340.5 | 338.1 | 20.6 |
| TLE2071AIDR | SOIC | D | 8 | 2500 | 340.5 | 338.1 | 20.6 |
| TLE2071IDR | SOIC | D | 8 | 2500 | 340.5 | 338.1 | 20.6 |
| TLE2072AIDR | SOIC | D | 8 | 2500 | 340.5 | 338.1 | 20.6 |
| TLE2072CDR | SOIC | D | 8 | 2500 | 340.5 | 338.1 | 20.6 |
| TLE2072IDR | SOIC | D | 8 | 2500 | 340.5 | 338.1 | 20.6 |
| TLE2072IDR | SOIC | D | 8 | 2500 | 367.0 | 367.0 | 35.0 |
| TLE2072IDR | SOIC | D | 8 | 2500 | 367.0 | 367.0 | 35.0 |
| TLE2074CDWR | SOIC | DW | 16 | 2000 | 367.0 | 367.0 | 38.0 |
| TLE2074IDWR | SOIC | DW | 16 | 2000 | 367.0 | 367.0 | 38.0 |

JG (R-GDIP-T8)

CERAMIC DUAL-IN-LINE

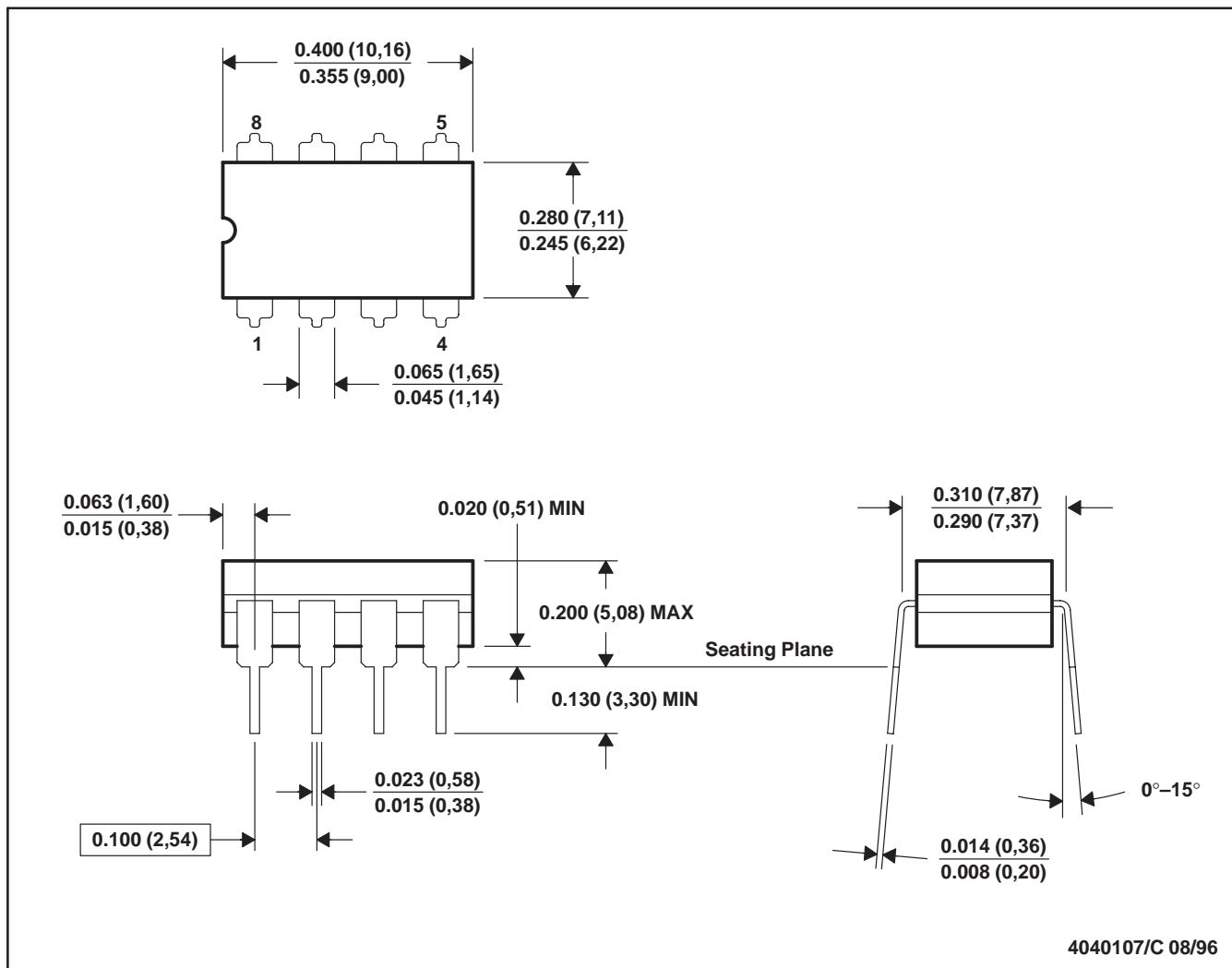

- NOTES: A. All linear dimensions are in inches (millimeters).
 B. This drawing is subject to change without notice.
 C. This package can be hermetically sealed with a ceramic lid using glass frit.
 D. Index point is provided on cap for terminal identification.
 E. Falls within MIL STD 1835 GDIP1-T8

J (R-GDIP-T**)

14 LEADS SHOWN

CERAMIC DUAL IN-LINE PACKAGE

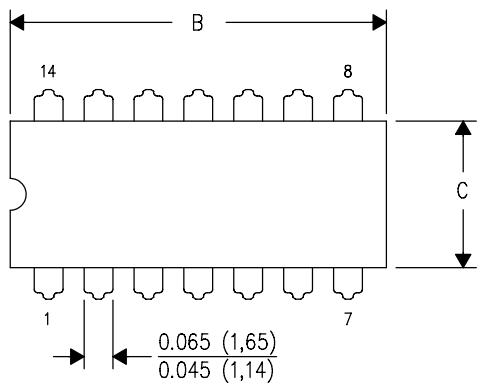

| DIM \ PINS ** | 14 | 16 | 18 | 20 |
|---------------|------------------------|------------------------|------------------------|------------------------|
| A | 0.300 (7,62) BSC | 0.300 (7,62) BSC | 0.300 (7,62) BSC | 0.300 (7,62) BSC |
| B MAX | 0.785 (19,94) | .840 (21,34) | 0.960 (24,38) | 1.060 (26,92) |
| B MIN | — | — | — | — |
| C MAX | 0.300 (7,62) | 0.300 (7,62) | 0.310 (7,87) | 0.300 (7,62) |
| C MIN | 0.245 (6,22) | 0.245 (6,22) | 0.220 (5,59) | 0.245 (6,22) |

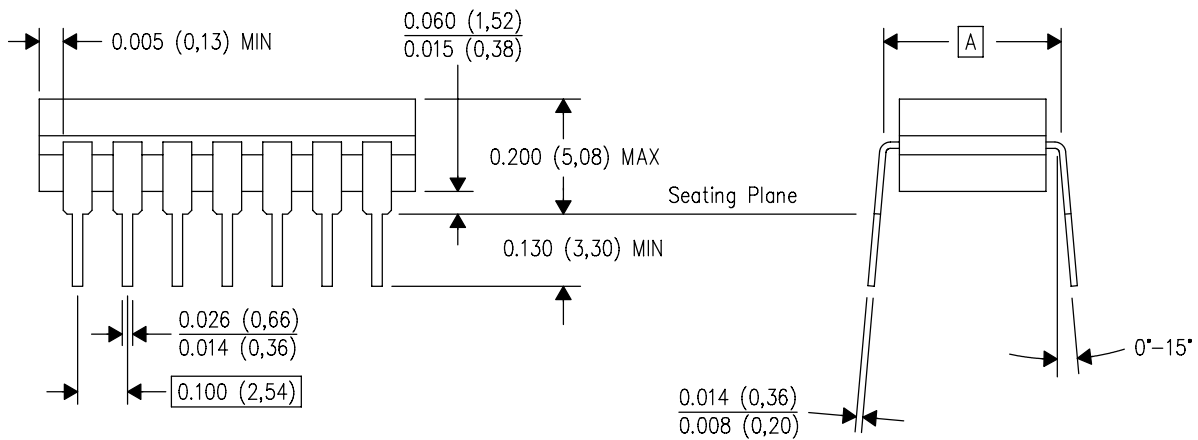

4040083/F 03/03

- NOTES:
- All linear dimensions are in inches (millimeters).
 - This drawing is subject to change without notice.
 - This package is hermetically sealed with a ceramic lid using glass frit.
 - Index point is provided on cap for terminal identification only on press ceramic glass frit seal only.
 - Falls within MIL STD 1835 GDIP1-T14, GDIP1-T16, GDIP1-T18 and GDIP1-T20.

U (S-GDFP-F10)

CERAMIC DUAL FLATPACK

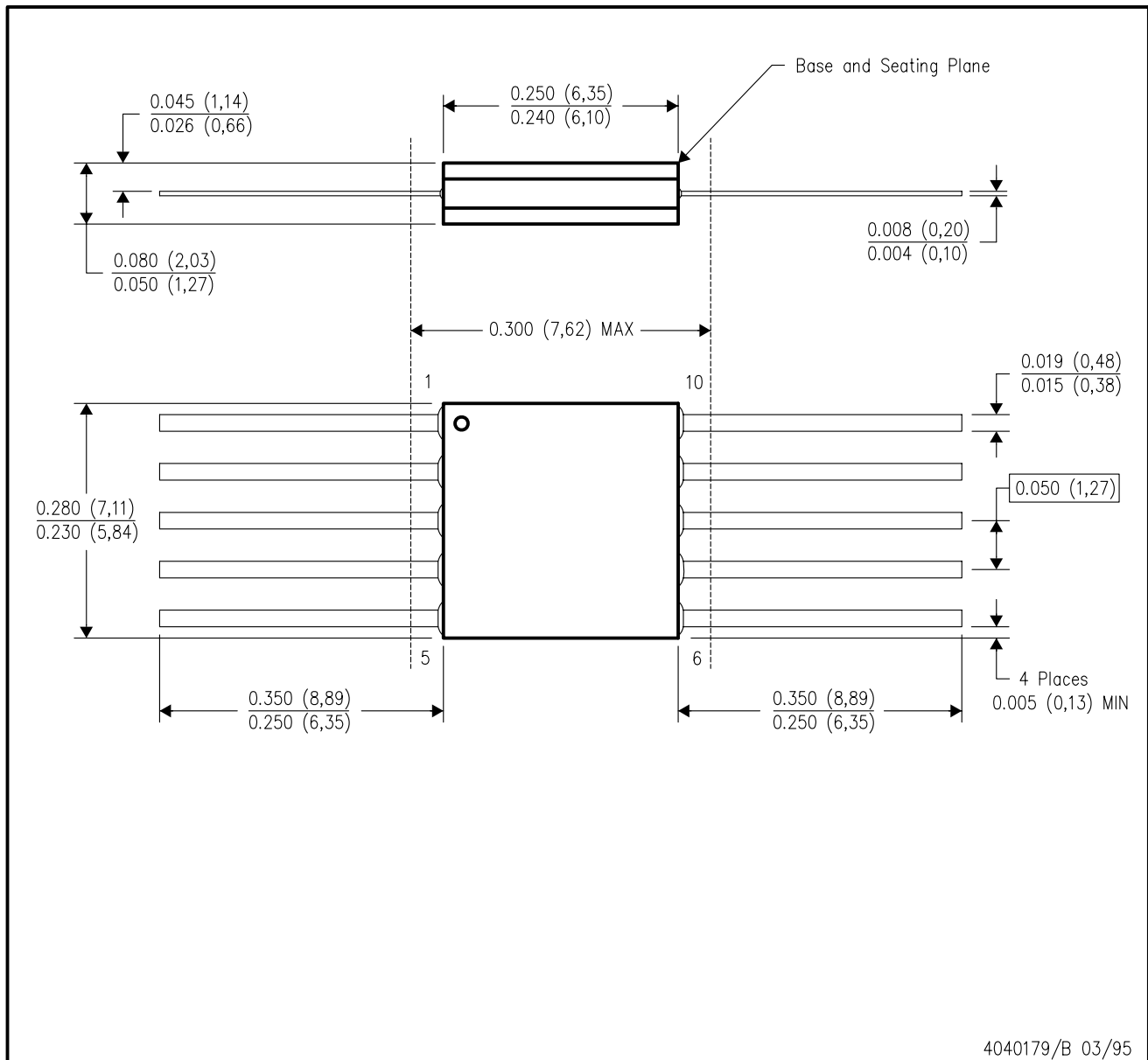

- NOTES:
- All linear dimensions are in inches (millimeters).
 - This drawing is subject to change without notice.
 - This package can be hermetically sealed with a ceramic lid using glass frit.
 - Index point is provided on cap for terminal identification only.
 - Falls within MIL STD 1835 GDFP1-F10 and JEDEC MO-092AA

W (R-GDFP-F14)

CERAMIC DUAL FLATPACK

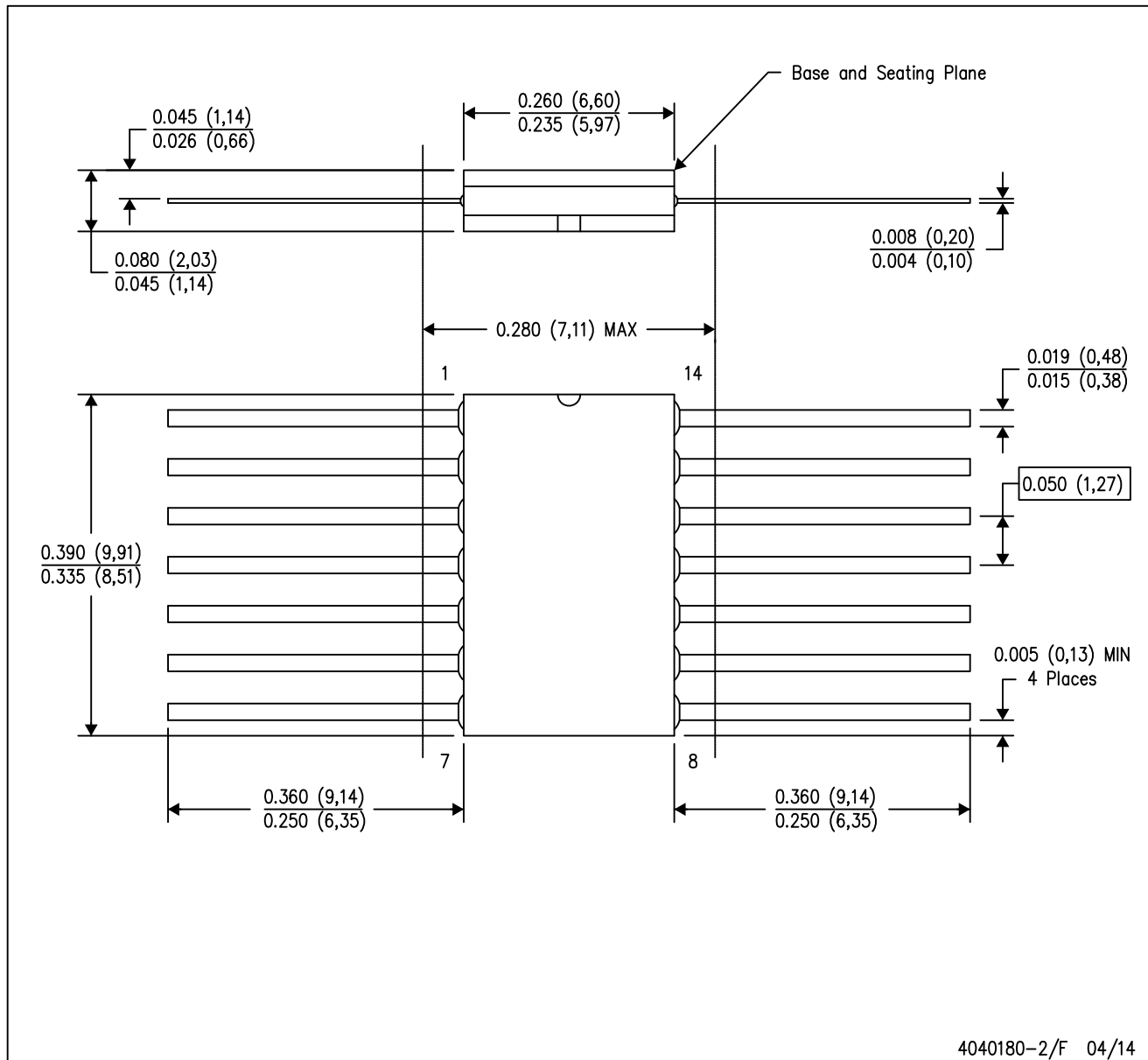

- NOTES:
- A. All linear dimensions are in inches (millimeters).
 - B. This drawing is subject to change without notice.
 - C. This package can be hermetically sealed with a ceramic lid using glass frit.
 - D. Index point is provided on cap for terminal identification only.
 - E. Falls within MIL STD 1835 GDFP1-F14

FK (S-CQCC-N**)

LEADLESS CERAMIC CHIP CARRIER

28 TERMINAL SHOWN

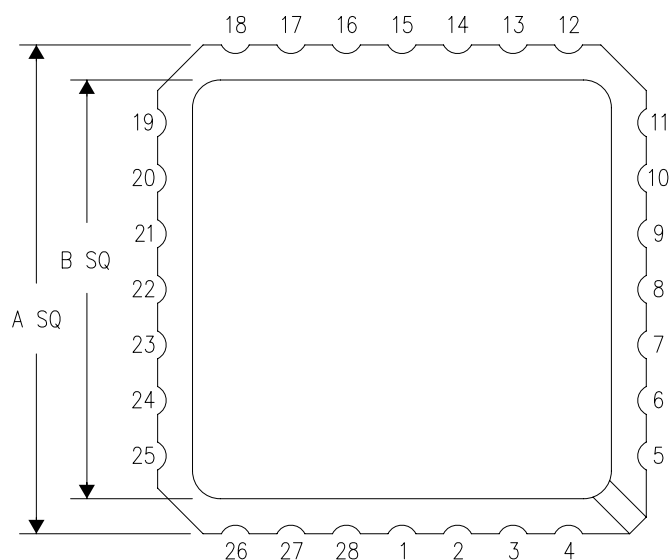

| NO. OF TERMINALS ** | A | | B | |
|---------------------|------------------|------------------|------------------|------------------|
| | MIN | MAX | MIN | MAX |
| 20 | 0.342 (8,69) | 0.358 (9,09) | 0.307 (7,80) | 0.358 (9,09) |
| 28 | 0.442 (11,23) | 0.458 (11,63) | 0.406 (10,31) | 0.458 (11,63) |
| 44 | 0.640 (16,26) | 0.660 (16,76) | 0.495 (12,58) | 0.560 (14,22) |
| 52 | 0.740 (18,78) | 0.761 (19,32) | 0.495 (12,58) | 0.560 (14,22) |
| 68 | 0.938 (23,83) | 0.962 (24,43) | 0.850 (21,6) | 0.858 (21,8) |
| 84 | 1.141 (28,99) | 1.165 (29,59) | 1.047 (26,6) | 1.063 (27,0) |

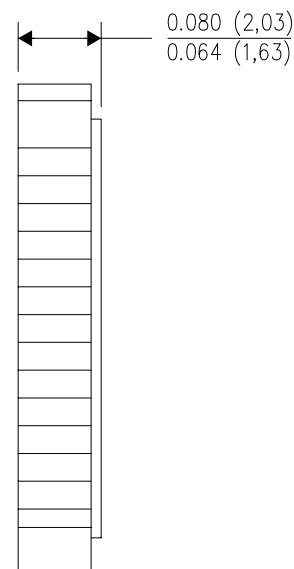
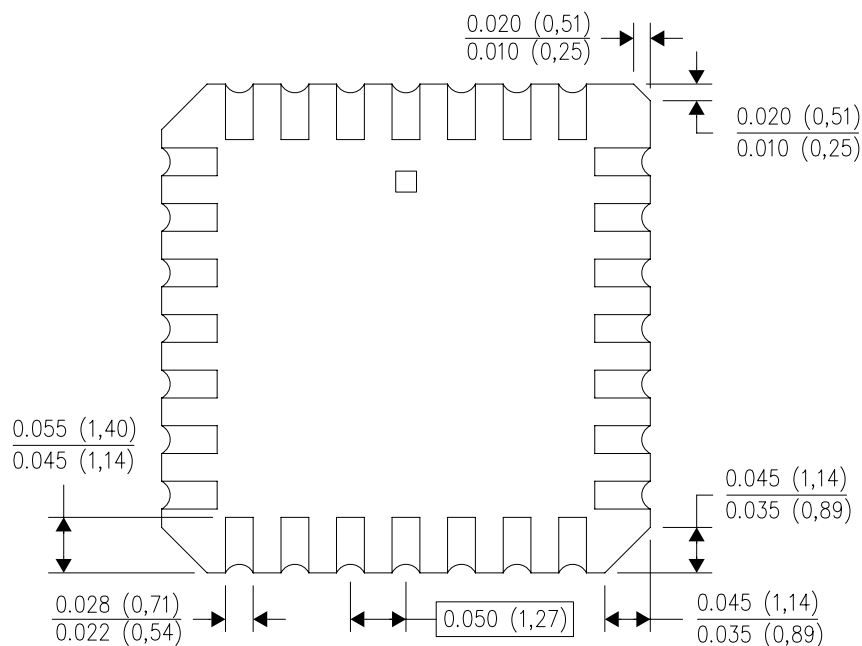

4040140/D 01/11

- NOTES:
- All linear dimensions are in inches (millimeters).
 - This drawing is subject to change without notice.
 - This package can be hermetically sealed with a metal lid.
 - Falls within JEDEC MS-004

P (R-PDIP-T8)

PLASTIC DUAL-IN-LINE PACKAGE

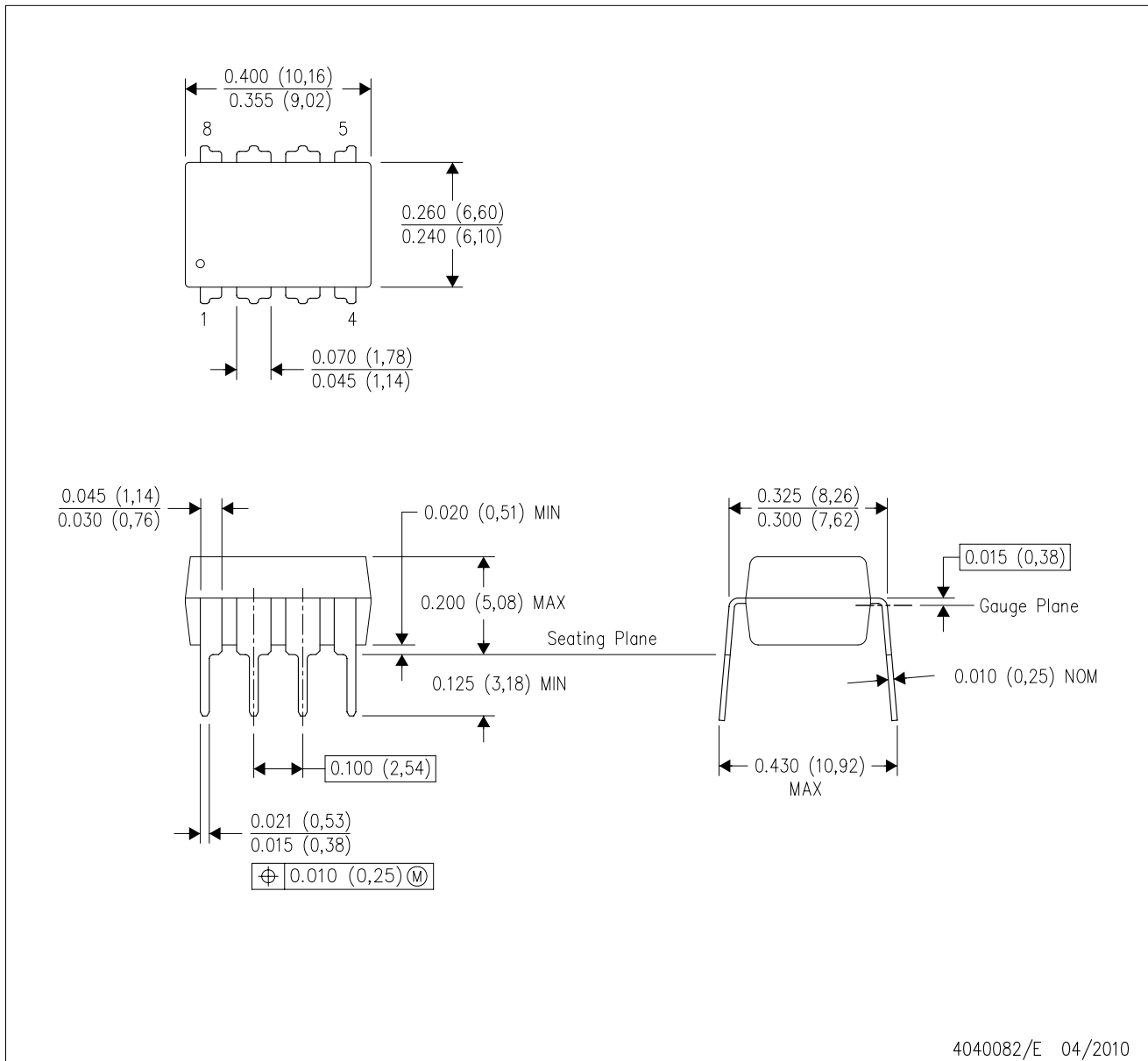

- NOTES:
- A. All linear dimensions are in inches (millimeters).
 - B. This drawing is subject to change without notice.
 - C. Falls within JEDEC MS-001 variation BA.

N (R-PDIP-T**)

PLASTIC DUAL-IN-LINE PACKAGE

16 PINS SHOWN

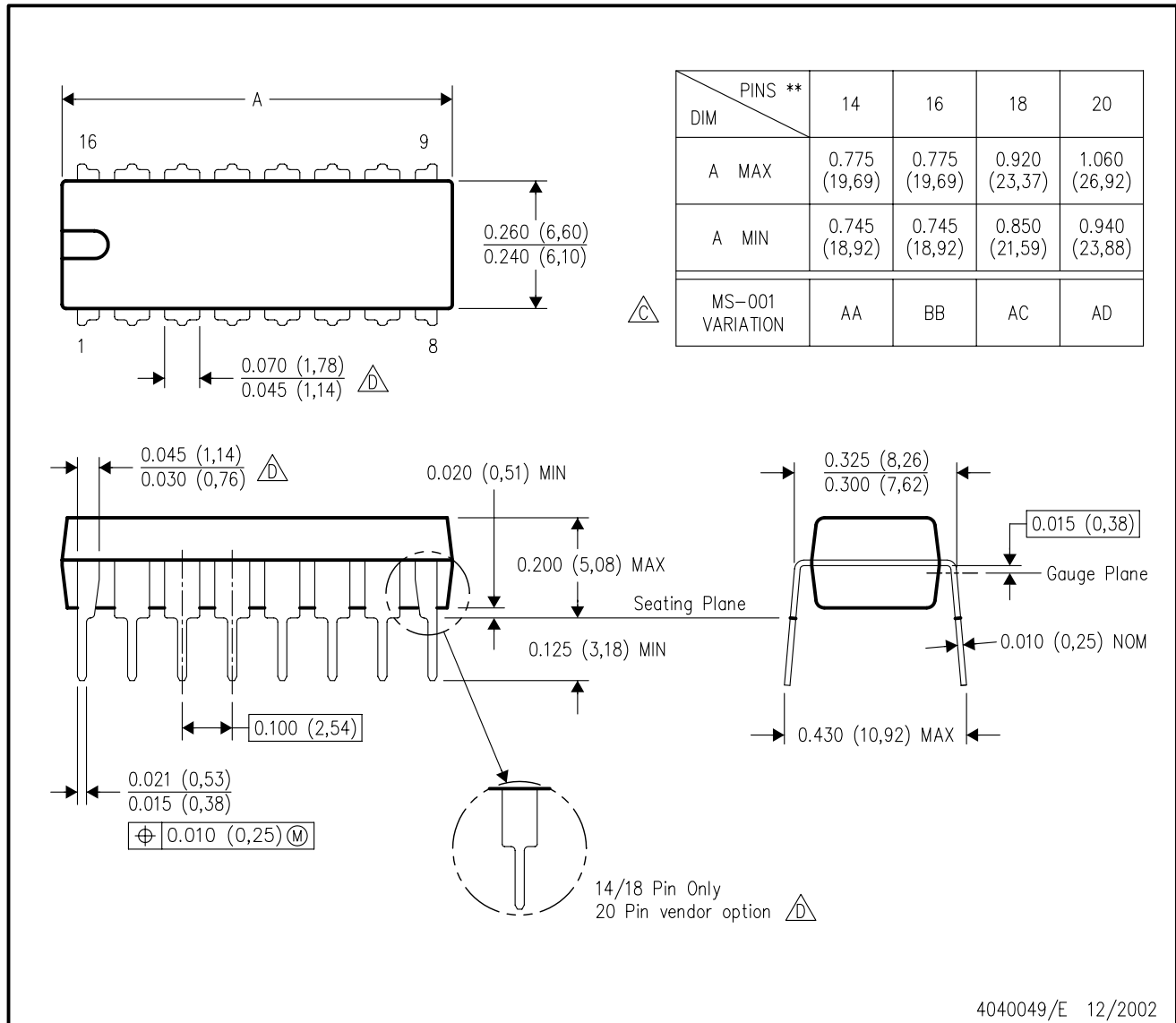

- NOTES:
- A. All linear dimensions are in inches (millimeters).
 - B. This drawing is subject to change without notice.
 - Falls within JEDEC MS-001, except 18 and 20 pin minimum body length (Dim A).
 - The 20 pin end lead shoulder width is a vendor option, either half or full width.

D (R-PDSO-G8)

PLASTIC SMALL OUTLINE

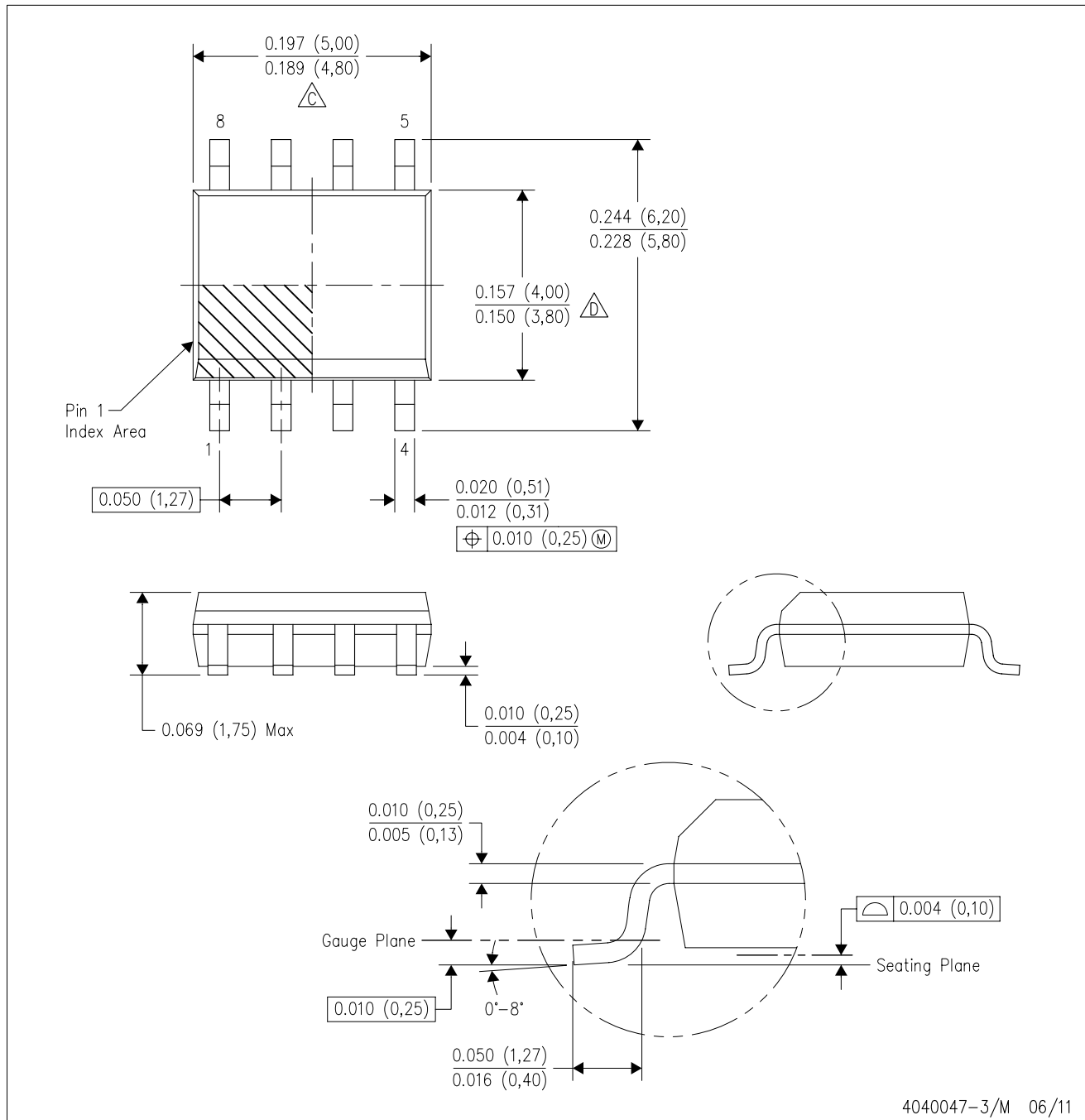

- NOTES:
- A. All linear dimensions are in inches (millimeters).
 - B. This drawing is subject to change without notice.
 - C. Body length does not include mold flash, protrusions, or gate burrs. Mold flash, protrusions, or gate burrs shall not exceed 0.006 (0,15) each side.
 - D. Body width does not include interlead flash. Interlead flash shall not exceed 0.017 (0,43) each side.
 - E. Reference JEDEC MS-012 variation AA.

D (R-PDSO-G8)

PLASTIC SMALL OUTLINE

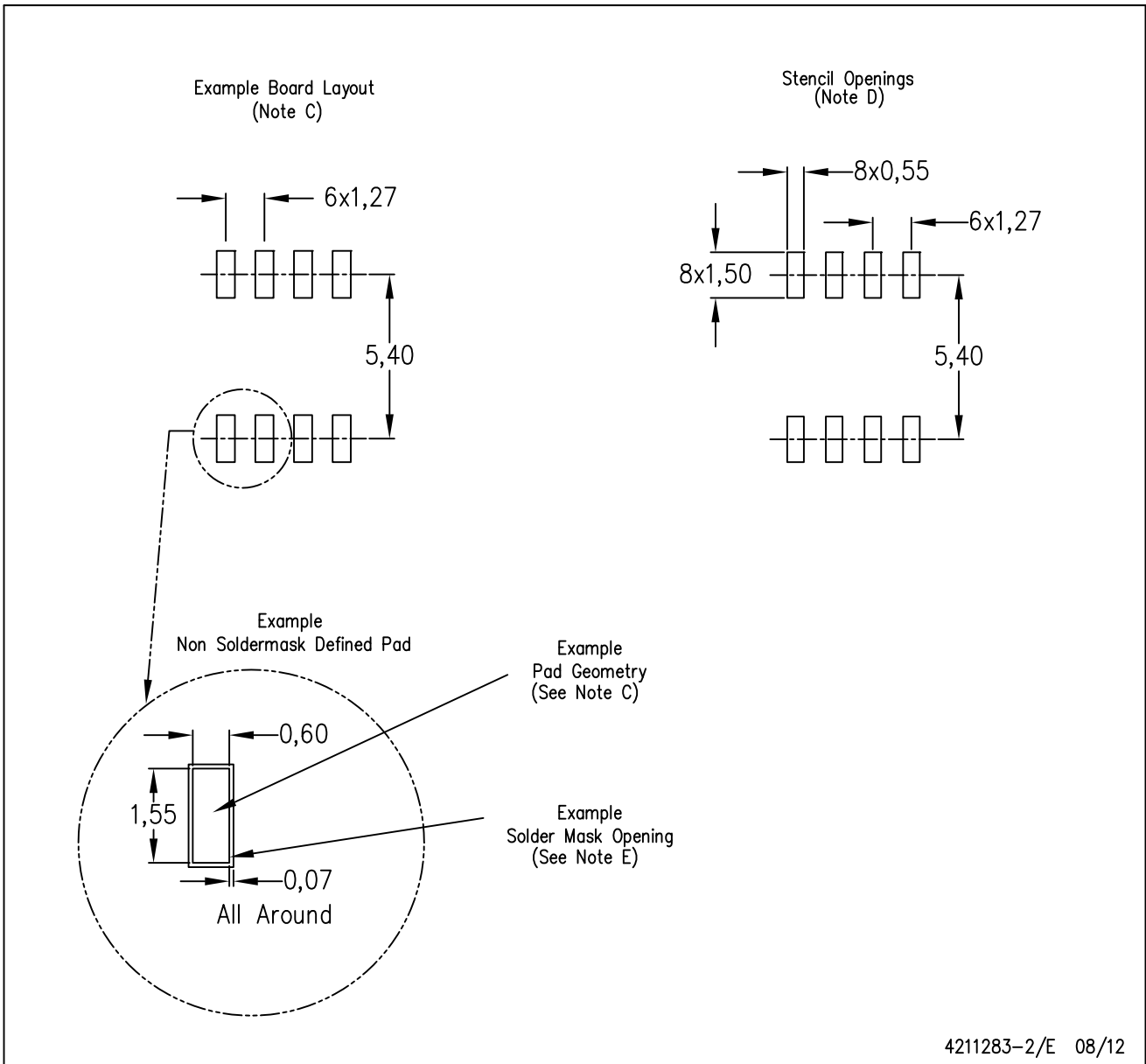

- NOTES:
- A. All linear dimensions are in millimeters.
 - B. This drawing is subject to change without notice.
 - C. Publication IPC-7351 is recommended for alternate designs.
 - D. Laser cutting apertures with trapezoidal walls and also rounding corners will offer better paste release. Customers should contact their board assembly site for stencil design recommendations. Refer to IPC-7525 for other stencil recommendations.
 - E. Customers should contact their board fabrication site for solder mask tolerances between and around signal pads.

DW (R-PDSO-G16)

PLASTIC SMALL OUTLINE

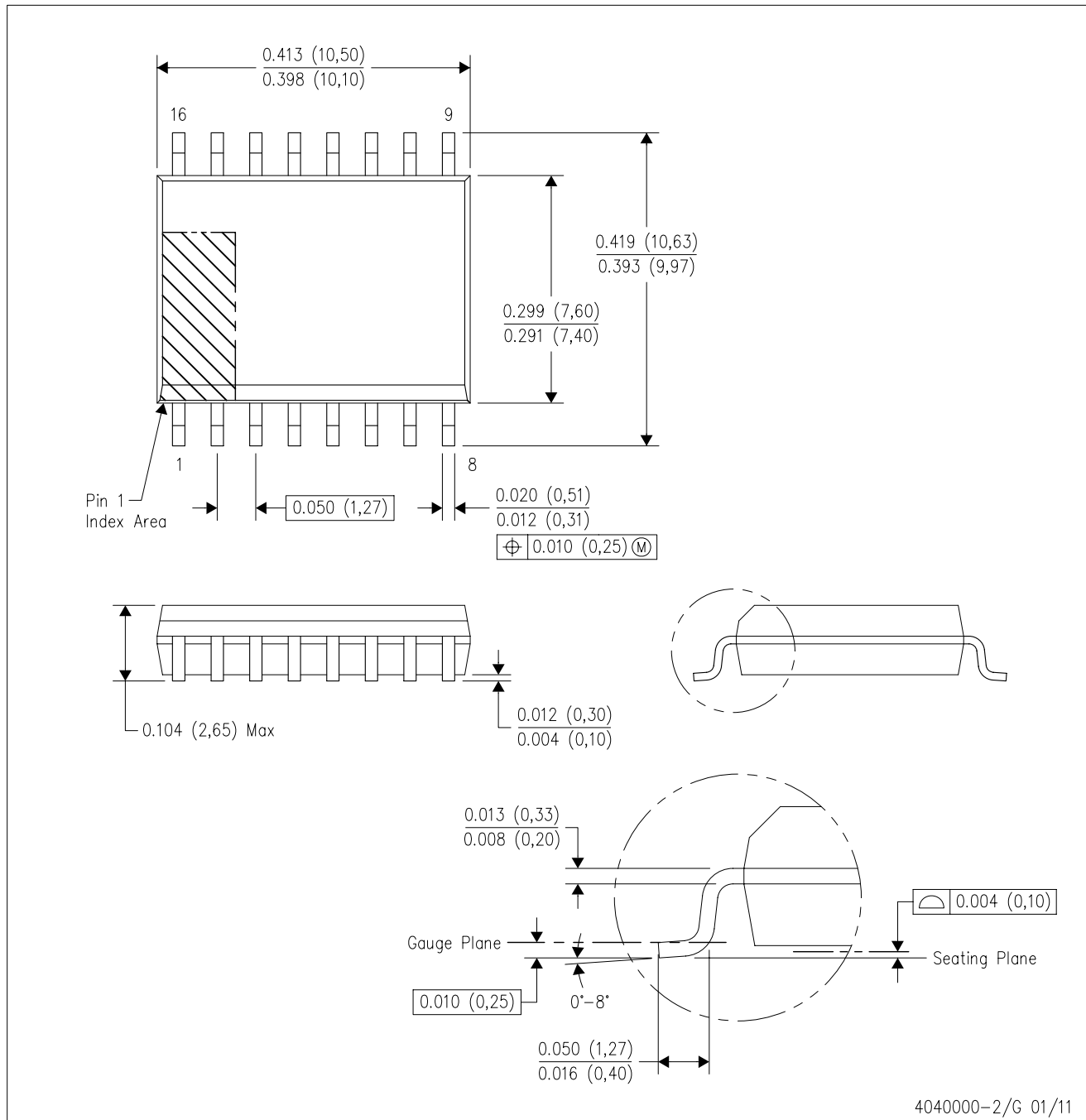

- NOTES:
- A. All linear dimensions are in inches (millimeters). Dimensioning and tolerancing per ASME Y14.5M-1994.
 - B. This drawing is subject to change without notice.
 - C. Body dimensions do not include mold flash or protrusion not to exceed 0.006 (0,15).
 - D. Falls within JEDEC MS-013 variation AA.

IMPORTANT NOTICE

Texas Instruments Incorporated and its subsidiaries (TI) reserve the right to make corrections, enhancements, improvements and other changes to its semiconductor products and services per JESD46, latest issue, and to discontinue any product or service per JESD48, latest issue. Buyers should obtain the latest relevant information before placing orders and should verify that such information is current and complete. All semiconductor products (also referred to herein as "components") are sold subject to TI's terms and conditions of sale supplied at the time of order acknowledgment.

TI warrants performance of its components to the specifications applicable at the time of sale, in accordance with the warranty in TI's terms and conditions of sale of semiconductor products. Testing and other quality control techniques are used to the extent TI deems necessary to support this warranty. Except where mandated by applicable law, testing of all parameters of each component is not necessarily performed.

TI assumes no liability for applications assistance or the design of Buyers' products. Buyers are responsible for their products and applications using TI components. To minimize the risks associated with Buyers' products and applications, Buyers should provide adequate design and operating safeguards.

TI does not warrant or represent that any license, either express or implied, is granted under any patent right, copyright, mask work right, or other intellectual property right relating to any combination, machine, or process in which TI components or services are used. Information published by TI regarding third-party products or services does not constitute a license to use such products or services or a warranty or endorsement thereof. Use of such information may require a license from a third party under the patents or other intellectual property of the third party, or a license from TI under the patents or other intellectual property of TI.

Reproduction of significant portions of TI information in TI data books or data sheets is permissible only if reproduction is without alteration and is accompanied by all associated warranties, conditions, limitations, and notices. TI is not responsible or liable for such altered documentation. Information of third parties may be subject to additional restrictions.

Resale of TI components or services with statements different from or beyond the parameters stated by TI for that component or service voids all express and any implied warranties for the associated TI component or service and is an unfair and deceptive business practice. TI is not responsible or liable for any such statements.

Buyer acknowledges and agrees that it is solely responsible for compliance with all legal, regulatory and safety-related requirements concerning its products, and any use of TI components in its applications, notwithstanding any applications-related information or support that may be provided by TI. Buyer represents and agrees that it has all the necessary expertise to create and implement safeguards which anticipate dangerous consequences of failures, monitor failures and their consequences, lessen the likelihood of failures that might cause harm and take appropriate remedial actions. Buyer will fully indemnify TI and its representatives against any damages arising out of the use of any TI components in safety-critical applications.

In some cases, TI components may be promoted specifically to facilitate safety-related applications. With such components, TI's goal is to help enable customers to design and create their own end-product solutions that meet applicable functional safety standards and requirements. Nonetheless, such components are subject to these terms.

No TI components are authorized for use in FDA Class III (or similar life-critical medical equipment) unless authorized officers of the parties have executed a special agreement specifically governing such use.

Only those TI components which TI has specifically designated as military grade or "enhanced plastic" are designed and intended for use in military/aerospace applications or environments. Buyer acknowledges and agrees that any military or aerospace use of TI components which have **not** been so designated is solely at the Buyer's risk, and that Buyer is solely responsible for compliance with all legal and regulatory requirements in connection with such use.

TI has specifically designated certain components as meeting ISO/TS16949 requirements, mainly for automotive use. In any case of use of non-designated products, TI will not be responsible for any failure to meet ISO/TS16949.

Products

| | |
|------------------------------|--------------------------------------------------------------------------------------|
| Audio | www.ti.com/audio |
| Amplifiers | amplifier.ti.com |
| Data Converters | dataconverter.ti.com |
| DLP® Products | www.dlp.com |
| DSP | dsp.ti.com |
| Clocks and Timers | www.ti.com/clocks |
| Interface | interface.ti.com |
| Logic | logic.ti.com |
| Power Mgmt | power.ti.com |
| Microcontrollers | microcontroller.ti.com |
| RFID | www.ti-rfid.com |
| OMAP Applications Processors | www.ti.com/omap |
| Wireless Connectivity | www.ti.com/wirelessconnectivity |

Applications

| | |
|-------------------------------|------------------------------------------------------------------------------------------|
| Automotive and Transportation | www.ti.com/automotive |
| Communications and Telecom | www.ti.com/communications |
| Computers and Peripherals | www.ti.com/computers |
| Consumer Electronics | www.ti.com/consumer-apps |
| Energy and Lighting | www.ti.com/energy |
| Industrial | www.ti.com/industrial |
| Medical | www.ti.com/medical |
| Security | www.ti.com/security |
| Space, Avionics and Defense | www.ti.com/space-avionics-defense |
| Video and Imaging | www.ti.com/video |

TI E2E Community

e2e.ti.com