

- Eight 1.0- to 1.3-Gigabits Per Second (Gbps) Synchronizable Transceivers
- Low Power Consumption <1.3 W at 1.25 Gbps
- IEEE 802.3z Gigabit Ethernet Compliant
- Differential VML Transmit Outputs With No External Components Necessary. PECL Compatible Levels
- Programmable High-Speed Output Preemphasis Levels
- Selectable Parallel Interface Modes:
 - Nibble-Wide Double Data Rate (DDR) Clocking Interface
 - Multiplexed Channel DDR Clock Interface
- Selectable Clock Tolerance Compensation
- Selectable On-Chip 8b/10b IEEE 802.3z Compliant Encoder and Decoder
- JEDEC-Compliant 1.8-V LVCMOS (Extendable to 2.5 V)
- 3.6-V Tolerant Inputs on Parallel I/O
- Internal Series Termination on LVCMOS Outputs to Drive 50-Ω Lines
- Comprehensive Suite of Built-In Testability Features (PRBS Generation and Verification, Serial Loopback, and Far-End Loopback)
- IEEE 802.3 Clause 22 Management Data Interface (MDIO) Support
- IEEE 1149.1 JTAG Support
- Hot-Plug Protection on Serial I/O
- No External Filter Components Required for PLLs
- Small Footprint 19×19-mm, 289-Terminal, 1,0-mm Ball-Pitch BGA
- Advanced Low-Power 0.18-μm CMOS Technology
- Commercial Temperature Rating (0°C to 70°C)

description

The TLK2208B is the third generation of Gigabit Ethernet transceivers from Texas Instruments combining high port density and ultralow power in a small form-factor footprint. The TLK2208B provides for high-speed full-duplex point-to-point data transmissions based on the IEEE 802.3z 1000-Mbps Ethernet specification. The TLK2208B supports data rates from 1.0 Gbps through 1.3 Gbps.

The primary application of this device is to provide building blocks for developing point-to-point baseband data transmission over controlled impedance media of 50 Ω. The transmission media can be printed circuit board traces, copper cables or fiber-optical interface modules. The ultimate rate and distance of data transfer is dependent upon the attenuation characteristics of the media and the noise coupling to the environment.

The TLK2208B performs the data encoding, decoding, serialization, deserialization, clock extraction and clock tolerance compensation functions for a physical layer interface device. Each channel operates at up to 1.3 Gbps providing up to 8.32 Gbps of aggregate data bandwidth over copper or optical-media interfaces.

The TLK2208B supports two selectable reduced-pin-count double-data-rate (DDR) timing interfaces, nibble mode and multiplexed channel mode, to a protocol device.

In the nibble interface mode, the parallel interface accepts nibble-wide unencoded or 8b/10b encoded data aligned to both the rising and falling edges of the transmit clock.

In the multiplexed channel mode, the parallel interface accepts 8-bit-wide unencoded or 10-bit-wide 8b/10b encoded data with channels A, C, E, and G aligned to the falling edge of the source synchronous transmit clock and channels B, D, F, and H aligned to the rising edge of the transmit clock. The receive path interface is done in the same manner.



Please be aware that an important notice concerning availability, standard warranty, and use in critical applications of Texas Instruments semiconductor products and disclaimers thereto appears at the end of this data sheet.

PRODUCTION DATA information is current as of publication date. Products conform to specifications per the terms of Texas Instruments standard warranty. Production processing does not necessarily include testing of all parameters.

TLK2208B 8-PORT GIGABIT ETHERNET TRANSCEIVER

SLLS578E – AUGUST 2003 – REVISED MARCH 2009

description (continued)

The TLK2208B aligns the recovered data clock frequency to the reference clock on each channel by means of a clock tolerance compensation circuit and internal FIFO that inserts or drops 20-bit IDLE codes as needed in the interpacket gap (IPG). In synchronous mode, the received data for all channels is aligned to a single receive data clock that is a buffered version of the reference clock.

The TLK2208B supports a selectable IEEE 802.3z compliant 8b/10b encoder/decoder in all its modes of operation.

The TLK2208B automatically locks onto incoming data without the need to pre-lock.

The TLK2208B provides a comprehensive series of built-in tests for self-test purposes including loopback and PRBS generation and verification. An IEEE 1149.1 JTAG port is also supported to aid in board-manufacturing testing.

The TLK2208B is housed in a small form-factor 19×19-mm, 289-terminal BGA with 1,0-mm ball pitch. The ball out and footprint are compatible with those of the PMC-Sierra PM8352 8-channel transceiver.†

The TLK2208B is characterized to support the commercial temperature range of 0°C to 70°C.

The TLK2208B consumes 1.3 W when operating at nominal conditions.

The TLK2208B is designed to be hot-plug capable. A power-on reset puts the serial side output signal terminals TX+/TX- in the high-impedance state during power up.

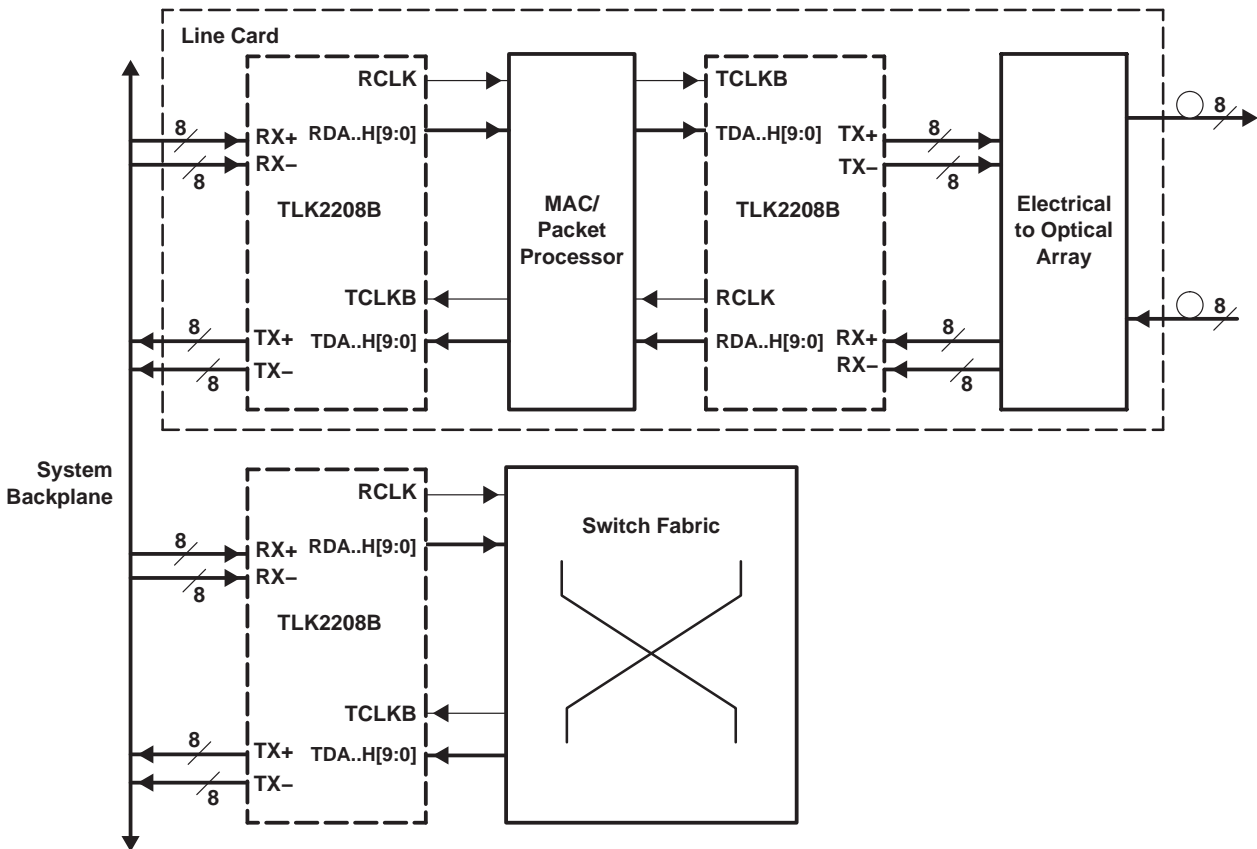

Figure 1. TLK2208B System Implementation Diagram

† Functionally compatible with the PM8352 in multiplex channel mode.

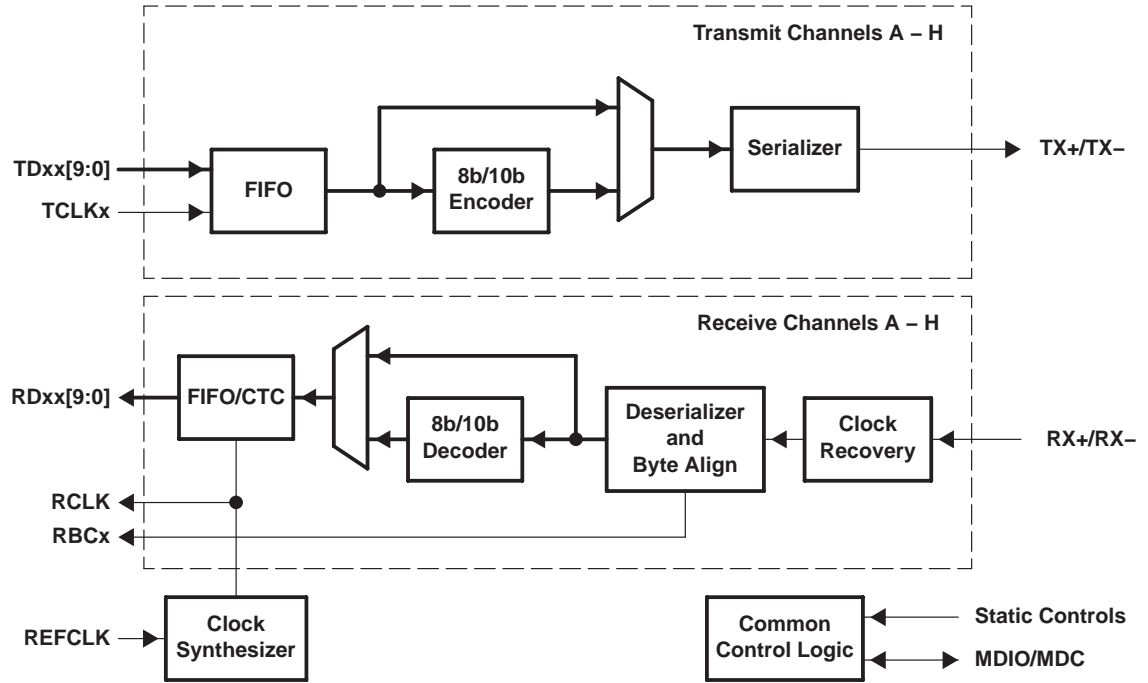

Figure 2. TLK2208B Block Diagram

TLK2208B

8-PORT GIGABIT ETHERNET TRANSCEIVER

SLLS578E – AUGUST 2003 – REVISED MARCH 2009

Pin Out
(Top View)

	A	B	C	D	E	F	G	H	J	K	L	M	N	P	R	T	U	
17	GND A	GND A	GND A	GND A	GND A	GND A	GND A	GND A	GND A	GND A	GND A	GND A	GND A	GND A	GND A	GND A	GND A	17
16	TXH+	TXG+	TXF+	TXE+	TXD+	TXC+	TXB+	TXA+	GND A	RXH+	RXG+	RXF+	RXE+	RXD+	RXC+	RXB+	RXA+	16
15	TXH-	TXG-	TXF-	TXE-	TXD-	TXC-	TXB-	TXA-	NC	RXH-	RXG-	RXF-	RXE-	RXD-	RXC-	RXB-	RXA-	15
14	GND A	GND A	GND A	GND A	GND A	GND A	GND A	GND A	NC	GND A	GND A	GND A	GND A	GND A	GND A	GND A	GND A	14
13	TDHG8	TDHG9	PRBS EN	ENABLE	VDDA	VDDA	VDDA	VDDA	VDDA	VDDA	VDDA	VDDA	VDDA	DVAD2	DVAD1	RDHG9	RDHG8	13
12	TDHG6	TDHG7	REF CLK	DVAD4	VDD	T-GND	T-GND	T-GND	T-GND	T-GND	T-GND	T-GND	VDD	MODE1	DVAD0	RDHG7	RDHG6	12
11	TDHG4	TDHG5	TMS	DVAD3	VDD	T-GND	T-GND	T-GND	T-GND	T-GND	T-GND	T-GND	VDD	MODE0	PLL_LOCK	RDHG5	RDHG4	11
10	TDHG2	TDHG3	TCK	NC	VDD	T-GND	T-GND	T-GND	T-GND	T-GND	T-GND	T-GND	VDD	RSVD	RCLK RBCH	RDHG3	RDHG2	10
9	TDHG0	TDHG1	TDI	TCLK_SEL	VDDQ	T-GND	T-GND	T-GND	T-GND	T-GND	T-GND	T-GND	VDDQ	BUSY EN	RBCG	RDHG1	RDHG0	9
8	TDFE8	TDFE9	GE_MOD	TRST	VDDQ	T-GND	T-GND	T-GND	T-GND	T-GND	T-GND	T-GND	VDDQ	RSVD	RBCF	RDFE9	RDFE8	8
7	TDFE6	TDFE7	TDO	LPBK	VDDQ	T-GND	T-GND	T-GND	T-GND	T-GND	T-GND	T-GND	VDDQ	RSVD	RBCE	RDFE7	RDFE6	7
6	TDFE4	TDFE5	TCLKH	NC	VDDQ	T-GND	T-GND	T-GND	T-GND	T-GND	T-GND	T-GND	VDDQ	NC	RBCD	RDFE5	RDFE4	6
5	TDFE2	TDFE3	TCLKF	NC	VDDQ	VDDQ	VDDQ	VDDQ	VDDQ	VDDQ	VDDQ	VDDQ	VDDQ	NC	RBCB	RDFE3	RDFE2	5
4	TDFE0	TDFE1	TCLKD	NC	GND	GND	GND	GND	GND	GND	GND	GND	GND	RBCA	RBCB	RDFE1	RDFE0	4
3	TDDC8	TDDC9	TDDC6	TDDC7	TCLKB	RSVD	RESET	MDC	CV_DIS_EN	NC	NC	NC	NC	RDDC7	RDDC6	RDDC9	RDDC8	3
2	TDDC4	TDDC5	TDDC1	TDBA1	TDBA3	TDBA5	TDBA7	TDBA9	CODE	RDBA1	RDBA3	RDBA5	RDBA7	RDBA9	RDDC1	RDDC5	RDDC4	2
1	TDDC3	TDDC2	TDDC0	TDBA0	TDBA2	TDBA4	TDBA6	TDBA8	MDIO	RDBA0	RDBA2	RDBA4	RDBA6	RDBA8	RDDC0	RDDC2	RDDC3	1

NOTE: Unused inputs that do not hold an integrated pullup or pulldown circuit need to be terminated to either VDDQ or GND, respectively, to avoid excessive currents and lifetime degradation.

Figure 3. Terminal Diagram

Signal Terminal Description

Serial I/O Signals

SIGNAL	LOCATION	TYPE	DESCRIPTION
TX[A:H]+ TX[A:H]–	H16:A16 H15:A15	VML output	Differential output transmit. TX[A:H]+ and TX[A:H]– are differential serial outputs that interface to a copper or an optical I/F module. TX[A:H]+ and TX[A:H]– are put in a high-impedance state when LPBK = high or when the LOOPBACK bit for a particular channel in the MDIO registers is set.
RX[A:H]+ RX[A:H]–	U16:K16 U15:K15	PECL- compatible input	Differential input receive. RX[A:H]+ and RX[A:H]– together are the differential serial input interface from a copper or an optical I/F module. Differential resistive termination is built-in for these terminals.

Transmit Data Bus and Clock Signals

SIGNAL	LOCATION	TYPE	DESCRIPTION
REFCLK	C12	LVC MOS input	Reference clock. REFCLK is an external input clock that provides the clock reference for synchronizing the receiver and transmitter interfaces. REFCLK is supposed to run from 100 MHz up to 130 MHz for 1 Gbps up to 1.3 Gbps operation of the serial interface.
TCLKB	E3	LVC MOS input with P/U	Transmit data clock. When in synchronized channel modes, the data on TDBA[9:0], TDDC[9:0], TDFE[9:0] and TDHG[9:0] is latched on both the rising and falling edges of TCLKB. When in independent channel modes, TCLKB latches TDBA[9:0] data on both its rising and falling edges.
TCKD, TCKF, TCKH	C4, C5, C6	LVC MOS input with P/U	Transmit data clock channels C and D, E and F, G and H. When in independent channel mode, these terminals are used to latch data for their perspective channels on both the rising and falling edges. TCKD applies to channels C and D, TCKF applies to channels E and F, and TCKH applies to channels G and H.
TDBA[7:0]	G2, G1, F2, F1, E2, E1, D2, D1	LVC MOS input	Transmit data channels A and B. The parallel data is clocked into the transceiver on the rising and falling edges of TCLKB and transmitted as a serial stream with TDBA0 sent as the first bit. In multiplexed channel mode, data for channel B is aligned to the rising edge of TCLKB and data for channel A is aligned to the falling edge of TCLKB. In nibble interface mode, data is input least-significant nibble first, aligned to the falling edge of TCLKB, followed by the most-significant nibble aligned to the rising edge. When CODE = high, TDBA3 acts as the K-character indicator for channel A.
TDBA8	H2	LVC MOS input	Transmit data, K-generator channels A and B. In multiplexed channel mode, when CODE = low, this terminal is the 9 th bit of a 10-bit word to be transmitted. When CODE = high, this terminal acts as the K-character indicator. When TDBA8 = high, the data on TDBA[7:0] is encoded into a K-character. In nibble interface mode, when CODE = low, this terminal is the 4 th and 9 th bits of a 10-bit word to be transmitted on channel B. When CODE = high, this terminal acts as the K-character indicator for channel B. Data is latched on the rising and falling edges of TCLKB.
TDBA9	H1	LVC MOS input with P/D	Transmit data channels A and B. When CODE = low, this terminal is the 10 th bit of a 10-bit word. When CODE = high, this terminal should be left floating or tied low to ground. Data is latched on the rising and falling edges of TCLKB.
TDDC[7:0]	D3, C3, B2, A2, A1, B1, C2, C1	LVC MOS input	Transmit data channels C and D. The parallel data is clocked into the transceiver on the rising and falling edges of the transmit clock and transmitted as a serial stream with bit 0 sent as the first bit. In independent channel mode, the transmit clock that latches this input is TCLKD. In all other modes, the transmit clock is TCLKB. In multiplexed channel mode, data for channel D is aligned to the rising edge of the transmit clock and data for channel C is aligned to its falling edge. In nibble interface mode, data is input least-significant nibble first, aligned to the falling edge of the transmit clock, followed by the most-significant nibble aligned to the rising edge of the transmit clock. Channel C data is input on TDDC[4:0] and channel D on TDDC[9:5]. When CODE = high, TDDC3 acts as the K-character indicator for channel C.

TLK2208B

8-PORT GIGABIT ETHERNET TRANSCEIVER

SLLS578E – AUGUST 2003 – REVISED MARCH 2009

SIGNAL	LOCATION	TYPE	DESCRIPTION
TDDC8	A3	LVC MOS input	<p>Transmit data, K-generator channels C and D. In multiplexed channel mode, when CODE = low, this terminal is the 9th bit of a 10-bit word to be transmitted. When CODE = high, this terminal acts as the K-character indicator. When TDDC8 = high, the data on TDDC[7:0] is encoded into a K-character.</p> <p>In nibble interface mode, when CODE = low, this terminal is the 4th and 9th bits of a 10-bit word to be transmitted on channel D. When CODE = high, this terminal acts as the K-character indicator for channel D.</p> <p>In independent channel mode, the transmit clock that latches this input is TCLKD. In all other modes the transmit clock is TCLKB.</p>
TDDC9	B3	LVC MOS input with P/D	<p>Transmit data channels C and D. When CODE = low, this terminal is the 10th bit of a 10-bit word. When CODE = high, this terminal should be left floating or tied low to ground.</p> <p>In independent channel mode, the transmit clock that latches this input is TCLKD. In all other modes, the transmit clock is TCLKB.</p>
TDFE[7:0]	B7, A7, B6, A6, B5, A5, B4, A4	LVC MOS input	<p>Transmit data channels E and F. The parallel data is clocked into the transceiver on the rising and falling edges of the transmit clock and transmitted as a serial stream with bit 0 sent as the first bit.</p> <p>In independent channel mode, the transmit clock that latches this input is TCLKF. In all other modes, the transmit clock is TCLKB.</p> <p>In multiplexed channel mode, data for channel F is aligned to the rising edge of the transmit clock and data for channel E is aligned to its falling edge.</p> <p>In nibble interface mode, data is input least-significant nibble first, aligned to the falling edge of the transmit clock, followed by the most-significant nibble aligned to the rising edge of the transmit clock. Channel E data is input on TDFE[4:0] and channel F on TDFE[9:5]. When CODE = high, TDDC3 acts as the K-character indicator for channel E.</p>
TDFE8	A8	LVC MOS input	<p>Transmit data, K-generator channels E and F. In multiplexed channel mode, when CODE = low, this terminal is the 9th bit of a 10-bit word to be transmitted. When CODE = high, this terminal acts as the K-character indicator. When TDFE8 = high, the data on TDFE[7:0] is encoded into a K-character.</p> <p>In nibble interface mode, when CODE = low, this terminal is the 4th and 9th bits of a 10-bit word to be transmitted on channel F. When CODE = high, this terminal acts as the K-character indicator for channel F.</p> <p>In independent channel mode, the transmit clock that latches this input is TCLKF. In all other modes the transmit clock is TCLKB.</p>
TDFE9	B8	LVC MOS input with P/D	<p>Transmit data channels E and F. When CODE = low, this terminal is the 10th bit of a 10-bit word. When CODE = high, this terminal should be left floating or tied low to ground.</p> <p>In independent channel mode, the transmit clock that latches this input is TCLKF. In all other modes, the transmit clock is TCLKB.</p>
TDHG[7:0]	B12, A12, B11, A11, B10, A10, B9, A9	LVC MOS input	<p>Transmit data channels G and H. The parallel data is clocked into the transceiver on the rising and falling edges of the transmit clock and transmitted as a serial stream with bit 0 sent as the first bit.</p> <p>In independent channel mode, the transmit clock that latches this input is TCLKD. In all other modes, the transmit clock is TCLKB.</p> <p>In multiplexed channel mode, data for channel H is aligned to the rising edge of the transmit clock and data for channel G is aligned to its falling edge.</p> <p>In nibble interface mode, data is input least-significant nibble first, aligned to the falling edge of the transmit clock, followed by the most-significant nibble aligned to the rising edge of the transmit clock. Channel G data is input on TDHG[4:0] and channel F on TDHG[9:5]. When CODE = high, TDHG3 acts as the K-character indicator for channel G.</p>

TLK2208B 8-PORT GIGABIT ETHERNET TRANSCEIVER

SLLS578E – AUGUST 2003 – REVISED MARCH 2009

SIGNAL	LOCATION	TYPE	DESCRIPTION
TDHG8	A13	LVC MOS input	<p>Transmit data, K-generator channels G and H. In multiplexed channel mode, when CODE = low, this terminal is the 9th bit of a 10-bit word to be transmitted. When CODE = high, this terminal acts as the K-character indicator. When TDHG8 = high, the data on TDHG[7:0] is encoded into a K-character.</p> <p>In nibble interface mode, when CODE = low, this terminal is the 4th and 9th bits of a 10-bit word to be transmitted on channel H. When CODE = high, this terminal acts as the K-character indicator for channel H.</p> <p>In independent channel mode, the transmit clock that latches this input is TCLKH. In all other modes, the transmit clock is TCLKB.</p>
TDHG9	B13	LVC MOS input with P/D	<p>Transmit data channels G and H. When CODE = low, this terminal is the 10th bit of a 10-bit word. When CODE = high, this terminal should be left floating or tied low to ground.</p> <p>In independent channel mode, the transmit clock that latches this input is TCLKH. In all other modes, the transmit clock is TCLKB.</p>

Receive Data Bus and Clock Signals

SIGNAL	LOCATION	TYPE	DESCRIPTION
RCLK/RBCH	R10	LVC MOS output	<p>Receive byte clock. In synchronized channel modes (nibble mode or multiplexed channel mode), RCLK is a buffered version of REFCLK used by the protocol device to latch the received data output on RDBA[9:0], RDDC[9:0], RDFE[9:0] and RDHG[9:0].</p> <p>With the internal CTC FIFO disabled (only valid for nibble interface mode), this clock is 1/10th the clock recovered from the incoming data stream. If CTC is enabled, this clock is a buffered version of REFCLK.</p> <p>This terminal is internally series-terminated to provide direct connection to a 50-Ω transmission line.</p>
RBC[G:A]	R9, R8, R7, R6, R5, R4, P4	LVC MOS output	<p>Individual receive byte clock channels A through G. Recovered clock for channels A through G.</p> <p>When in independent channel mode, these clocks are used by the protocol device to latch the received data output for channels A through G. Data is aligned to both the rising and falling edges. When in nibble interface mode with the internal CTC FIFO disabled, these terminals are 1/10th the clock recovered from the incoming data stream. If CTC is enabled, these clocks are all buffered versions of REFCLK.</p> <p>When in multiplexed channel mode, the RBCG clock becomes a complementary output to RCLK/RBCH. Similarly, RBCB and RBCA, RBCD and RBCC, RBCF and RBCE are paired clock copies of RCLK/RBCH and RBCG.</p> <p>These terminals are internally series-terminated to provide direct connection to a 50-Ω transmission line.</p>
RDBA[7:0]	N2, N1, M2, M1, L2, L1, K2, K1	LVC MOS output	<p>Receive data channels A and B. The parallel data is clocked out of the transceiver on the rising and falling edges of the receive clock.</p> <p>In multiplexed channel mode, data for channel B is aligned to the rising edge of RCLK and data for channel A is aligned to the falling edge of RCLK (see Figure 6 for clarity).</p> <p>In nibble mode, data is output least-significant nibble first, aligned to the falling edge of the receive clock, followed by the most-significant nibble aligned to the rising edge. Channel A is output on RDBA[4:0] and channel B is output on RDBA[9:5]. When CODE = high, RDBA3 acts as the K-flag bit for channel A on the rising edge of RCLK.</p> <p>These terminals are internally series-terminated to provide direct connection to a 50-Ω transmission line.</p>
RDBA8	P1	LVC MOS output	<p>Receive data/K-flag, channels A and B. The parallel data is clocked out of the transceiver on the rising and falling edges of the receive clock.</p> <p>In multiplexed channel mode, when CODE = low, this terminal is the 9th bit of a 10-bit word received. When CODE = high, this terminal acts as the K-flag bit. When RDBA8 = high, this terminal indicates that the data on RDBA[7:0] is a K-character.</p> <p>In nibble interface mode, when CODE = low, this terminal is the 4th and 9th bits of a 10-bit word received on channel B. When CODE = high, this terminal acts as the 4th bit on the falling edge and as the K-flag bit on the rising edge for channel B. When RDBA8 = high, this terminal indicates that the data on RDBA[7:0], output on the rising and falling edges of the receive clock, is a K-character.</p> <p>This terminal is internally series-terminated to provide direct connection to a 50-Ω transmission line.</p>

TLK2208B

8-PORT GIGABIT ETHERNET TRANSCEIVER

SLLS578E – AUGUST 2003 – REVISED MARCH 2009

SIGNAL	LOCATION	TYPE	DESCRIPTION
RDBA9	P2	LVC MOS output	<p>Receive data 9, channels A and B. The parallel data is clocked out of the transceiver on the rising and falling edges of the receive clock. In multiplexed channel mode, when CODE = low, this terminal is the 10th bit of a 10-bit word received.</p> <p>In nibble interface mode, when CODE = low, this terminal is the 5th and 10th bits of a 10-bit word received on channel B.</p> <p>This terminal is internally series-terminated to provide direct connection to a 50-Ω transmission line.</p>
RDDC[7:0]	P3, R3, T2, U2, U1, T1, R2, R1	LVC MOS output	<p>Receive data channels C and D. The parallel data is clocked out of the transceiver on the rising and falling edges of the receive clock.</p> <p>In multiplexed channel mode, data for channel D is aligned to the rising edge of RCLK and data for channel C is aligned to the falling edge of RCLK (see Figure 6 for clarity).</p> <p>In nibble mode, data is output least-significant nibble first, aligned to the falling edge of the receive clock, followed by the most-significant nibble aligned to the rising edge. Channel C is output on RDDC[4:0] and channel D is output on RDDC[9:5]. When CODE = high, RDDC3 acts as the K-flag bit for channel C on the rising edge of RCLK.</p> <p>These terminals are internally series-terminated to provide direct connection to a 50-Ω transmission line.</p>
RDDC8	U3	LVC MOS output	<p>Receive data/K-flag, channels C and D. The parallel data is clocked out of the transceiver on the rising and falling edges of the receive clock.</p> <p>In multiplexed channel mode, when CODE = low, this terminal is the 9th bit of a 10-bit word received. When CODE = high, this terminal acts as the K-flag bit. When RDDC8 = high, this terminal indicates that the data on RDDC[7:0] is a K-character.</p> <p>In nibble interface mode, when CODE = low, this terminal is the 4th and 9th bits of a 10-bit word received on channel D. When CODE = high, this terminal acts as the 4th bit on the falling edge and as the K-flag bit on the rising edge for channel D. When RDDC8 = high, this terminal indicates that the data on RDDC[7:0], output on the rising and falling edges of the receive clock, is a K-character.</p> <p>This terminal is internally series-terminated to provide direct connection to a 50-Ω transmission line.</p>
RDDC9	T3	LVC MOS output	<p>Receive data 9, channels C and D. The parallel data is clocked out of the transceiver on the rising and falling edges of the receive clock. In multiplexed channel mode, when CODE = low, this terminal is the 10th bit of a 10-bit word received.</p> <p>In nibble interface mode, when CODE = low, this terminal is the 5th and 10th bits of a 10-bit word received on channel D.</p> <p>This terminal is internally series-terminated to provide direct connection to a 50-Ω transmission line.</p>
RDFE[7:0]	T7, U7, T6, U6, T5, U5, T4, U4	LVC MOS output	<p>Receive data channels E and F. The parallel data is clocked out of the transceiver on the rising and falling edges of the receive clock.</p> <p>In multiplexed channel mode, data for channel F is aligned to the rising edge of RCLK and data for channel E is aligned to the falling edge of RCLK (see Figure 6 for clarity).</p> <p>In nibble mode, data is output least-significant nibble first, aligned to the falling edge of the receive clock, followed by the most-significant nibble aligned to the rising edge. Channel E is output on RDFE[4:0] and channel F is output on RDFE[9:5]. When CODE = high, RDFE3 acts as the K-flag bit for channel E on the rising edge of RCLK.</p> <p>These terminals are internally series-terminated to provide direct connection to a 50-Ω transmission line.</p>
RDFE8	U8	LVC MOS output	<p>Receive data/K-flag, channels E and F. The parallel data is clocked out of the transceiver on the rising and falling edges of the receive clock.</p> <p>In multiplexed channel mode, when CODE = low, this terminal is the 9th bit of a 10-bit word received. When CODE = high, this terminal acts as the K-flag bit. When RDFE8 = high, this terminal indicates that the data on RDFE[7:0] is a K-character.</p> <p>In nibble interface mode, when CODE = low, this terminal is the 4th and 9th bits of a 10-bit word received on channel F. When CODE = high, this terminal acts as the 4th bit on the falling edge and as the K-flag bit on the rising edge for channel F. When RDFE8 = high, this terminal indicates that the data on RDFE[7:0], output on the rising and falling edges of the receive clock, is a K-character.</p> <p>This terminal is internally series terminated to provide direct connection to a 50-Ω transmission line.</p>

TLK2208B

8-PORT GIGABIT ETHERNET TRANSCEIVER

SLLS578E – AUGUST 2003 – REVISED MARCH 2009

SIGNAL	LOCATION	TYPE	DESCRIPTION
RDFE9	T8	LVC MOS output	Receive data 9, channels E and F. The parallel data is clocked out of the transceiver on the rising and falling edges of the receive clock. In multiplexed channel mode, when CODE = low, this terminal is the 10 th bit of a 10-bit word received. In nibble interface mode, when CODE = low, this terminal is the 5 th and 10 th bits of a 10-bit word received on channel F. This terminal is internally series terminated to provide direct connection to a 50-Ω transmission line.
RDHG[7:0]	T12, U12, T11, U11, T10, U10, T9, U9	LVC MOS output	Receive data channels G and H. The parallel data is clocked out of the transceiver on the rising and falling edges of the receive clock. In multiplexed channel mode, data for channel H is aligned to the rising edge of RCLK and data for channel G is aligned to the falling edge of RCLK (see Figure 6 for clarity). In nibble mode, data is output least-significant nibble first, aligned to the falling edge of the receive clock, followed by the most significant nibble aligned to the rising edge. Channel G is output on RDHG[4:0] and channel H is output on RDHG[9:5]. When CODE = high, RDHG3 acts as the K-flag bit for channel G on the rising edge of RCLK. These terminals are internally series terminated to provide direct connection to a 50-Ω transmission line.
RDHG8	U13	LVC MOS output	Receive data/K-flag, channels G and H. The parallel data is clocked out of the transceiver on the rising and falling edges of receive clock. In multiplexed channel mode, when CODE = low, this terminal is the 9 th bit of a 10-bit word received. When CODE = high, this terminal acts as the K-flag bit. When RDFE8 = high, this terminal indicates that the data on RDHG[7:0] is a K-character. In nibble interface mode, when CODE = low, this terminal is the 4 th and 9 th bits of a 10-bit word received on channel H. When CODE = high, this terminal acts as the 4 th bit on the falling edge and as the K-flag bit on the rising edge for channel H. When RDHG8 = high, this terminal indicates that the data on RDHG[7:0], output on the rising and falling edges of the receive clock, is a K-character. This terminal is internally series-terminated to provide direct connection to a 50-Ω transmission line.
RDHG9	T13	LVC MOS output	Receive data 9, channels G and H. The parallel data is clocked out of the transceiver on the rising and falling edges of the receive clock. In multiplexed channel mode, when CODE = low, this terminal is the 10 th bit of a 10-bit word received. In nibble interface mode, when CODE = low, this terminal is the 5 th and 10 th bits of a 10-bit word received on channel H. This terminal is internally series-terminated to provide direct connection to a 50-Ω transmission line.

Management Data Interface Signals

SIGNAL	LOCATION	TYPE	DESCRIPTION
MDIO	J1	LVC MOS I/O with P/U	Management data I/O. MDIO is the bidirectional serial data path for the transfer of management data to and from the protocol device.
MDC	H3	LVC MOS input	Management data clock. MDC is the clock reference for the transfer of management data to and from the protocol device.
DVAD[4:0]	D12, D11, P13, R13, R12	LVC MOS input with P/D	Management address. Device address: DVAD[4:0] is the externally set physical address given to this device, used to distinguish one device from another. This address is latched on the rising edge of RESET.

TLK2208B

8-PORT GIGABIT ETHERNET TRANSCEIVER

SLLS578E – AUGUST 2003 – REVISED MARCH 2009

JTAG Interface Signals

SIGNAL	LOCATION	TYPE	DESCRIPTION
TCK	C10	LVC MOS input	Test clock. IEEE 1149.1 (JTAG) TCK is used to clock state information and test data into and out of the device during the operation of the test port.
TDI	C9	LVC MOS input with P/U	Test data input. IEEE 1149.1 (JTAG) TDI is used to shift test data and test instructions into the device serially during the operation of the test port.
TDO	C7	LVC MOS output	Test data output. IEEE 1149.1 (JTAG) TDO is used to shift test data and test instructions out of the device serially during operation of the test port. When the JTAG port is not in use, TDO is in a high-impedance state.
TMS	C11	LVC MOS input with P/U	Test mode select. IEEE 1149.1 (JTAG) TMS is used to control the state of the internal test-port controller.
TRST	D8	LVC MOS input with P/U	JTAG reset. IEEE 1149.1 (JTAG) TRST is used to reset the internal JTAG controller.

Miscellaneous Signals

SIGNAL	LOCATION	TYPE	DESCRIPTION
CODE	J2	LVC MOS input with P/D	Encode enable. When high, the 8b/10b encoder and decoder are enabled. The logic value of this terminal is logically ORed with MDIO register 17.7 (8b/10b_EN).
CV_DIS_EN	J3	LVC MOS input with P/D	Code violation/disparity error code enable. When CV_DIS_EN is high, the outputs RDxx[9:0] are set to 1 when a code violation or disparity error is detected. The logic value of this terminal is logically ORed with the MDIO register 17.14 (CVDispEn). This requires CODE to be enabled.
RESET	G3	LVC MOS input with P/D	Chip reset (FIFO clear). Pulling this terminal high recenters the transmit skew buffers, recenters receive channel synchronization FIFOs, and resets MDIO flags.
LPBK	D7	LVC MOS input with P/D	Serial loopback enable. When asserted high, the outputs of the 8b/10b encoder are looped into the inputs of the 8b/10b decoder for each channel. The serial transmit outputs are held in the high-impedance state and the serial inputs are ignored. Whenever a channel is switched into or out of LoopBack, that channel should be reset.
MODE1 MODE0	P12, P11	LVC MOS input with P/D	Configuration terminals. These terminals put the device under one of the following operation modes: MODE[1:0] 00 – Multiplexed channel mode 01 – Reserved 10 – Nibble interface mode 11 – Reserved
ENABLE	D13	LVC MOS input with P/U	Device enable. Pulling this terminal high enables all outputs of the device. A low on this terminal places all outputs for the device in the high-impedance state.
TCLKSEL	D9	LVC MOS input	Transfer clock select. This terminal controls clock selection mode between synchronized and independent channel mode. In independent channel mode (TCLKSEL = 1) channels are clocked in and out by independent clocks TLCK[B:H] and RBC[A:H], respectively. In synchronized channel mode (TCLKSEL = 0) transmit and receive clocks are centered around TCLKB and RCLK/RBCH. The logic value of this signal is ORed with TransClkMode, MDIO register R17.15.
BUSYEN	P9	LVC MOS input with P/U	Busy mode enable. When asserted high, /K28.5/D10.1/ are treated as valid data and passed through the FIFO. When in the low state it causes high /K28.5/D10.1/ to be treated as an IDLE sequence that can be deleted.
PLL_LOCK	R11	LVC MOS output	PLL lock. When asserted high, this terminal provides an indication that sufficient time has elapsed after a power-cycle or power-down sequence to ensure that PLLs have achieved lock.

GE_MOD	C8	LVC MOS input	<p>Gigabit Ethernet mode. When driven high, the chip:</p> <ol style="list-style-type: none"> 1) Treats /K28.5/ followed by any valid data character as an IDLE sequence, except that when BMOD is asserted, the chip treats /K28.5/D10.1/ as described in the BMOD terminal description. 2) Modifies IDLE to correct disparity by substituting /D5.6/ for /D16.2/ in a /K28.5/Dx.y/ transmit IDLE pair. <p>There is a state machine coded into the IDLE correction logic for each channel of the TLK2208B such that whenever there is a stream of two or more consecutive K28.5 codes clocked into the TLK2208B then the IDLE correction logic is disabled. If there is ever a reason to clock a continuous stream of K28.5 codes into the transmit side of the TLK2208B, then following that stream of K codes with any two D codes will re-enable the IDLE correction circuit and all subsequent IDLE patterns will conform to the IEEE802.3z specification. Note the steady stream of continuous K28.5 codes does not conform to IEEE802.3 protocol.</p> <p>The logic value of the GE_MOD terminal is ORed with GEMODE register 24.15.</p>
PRBSEN	C13	LVC MOS input with P/D	<p>PRBS enable. When this terminal is asserted high, the pseudorandom bit stream generator and comparator circuits are inserted into the transmit and receive data paths on all channels, respectively.</p> <p>If this terminal is not used it can be tied to the GND reference.</p> <p>TX+/TX- are transmitting 2^7-1 PRBS. RX+/RX- are comparing incoming data to an internally generated 2^7-1 PRBS. Results of the RX comparison can be read from the MDIO.</p>

Power and Reference Terminal Descriptions

SIGNAL	LOCATION	TYPE	DESCRIPTION
VDDQ	E9, E8, E7, E6, E5, F5, G5, H5, J5, K5, L5, M5, N5, N6, N7, N8, N9	Supply	I/O supply voltage. 1.8 V \pm 0.2 V or 2.5 V \pm 0.2 V
VDD	E10, E11, E12, N10, N11, N12	Supply	Digital logic power. Provides power for all digital circuitry. Nominally 1.8 V
VDDA	E13, F13, G13, H13, J13, K13, L13, M13, N13	Supply	Analog power. VDDA provides a supply reference for the high-speed analog circuits, receiver and transmitter. Nominally 1.8 V
GROUND			
GNDA	E14, F14, G14, H14, J16, J17, K14, L14, M14, N14	Ground	Analog ground. GNDA provides a ground reference for the high-speed analog circuits, RX and TX.
GND	E4, F4, G4, H4, J4, K4, L4, M4, N4, A14, B14, C14, D14, P14, R14, T14, U14, A17, B17, C17, D17, E17, F17, G17, H17, K17, L17, M17, N17, P17, R17, T17, U17	Ground	Digital logic ground. Provides a ground for the logic circuits and digital I/O buffers.

Reserved and NC Signals

SIGNAL	LOCATION	TYPE	DESCRIPTION
RSVD	F3, P7, P8, P10	RSVD	Reserved. Terminals available to TI test. These terminals should not be externally connected.
NC	D4, D5, D6, D10, J14, J15, K3, L3, M3, N3, P5, P6		NC. These signal terminals have no internal connection.

Terminal-to-Signal Map

TERMINAL NUMBER	TERMINAL FUNCTION	MULTIPLEXED CHANNEL MODE	NIBBLE INTERFACE SYNCHRONIZED AND INDEPENDENT CHANNEL MODES
A1	TDDC3	Transmit bus channel D/C bit 3	Transmit bus channel C bits 8, 3, K-bit
A2	TDDC4	Transmit bus channel D/C bit 4	Transmit bus channel C bits 9, 4

TLK2208B

8-PORT GIGABIT ETHERNET TRANSCEIVER

SLLS578E – AUGUST 2003 – REVISED MARCH 2009

TERMINAL NUMBER	TERMINAL FUNCTION	MULTIPLEXED CHANNEL MODE	NIBBLE INTERFACE SYNCHRONIZED AND INDEPENDENT CHANNEL MODES
A3	TDDC8	Transmit bus channel D/C bit 8, K-bit	Transmit bus channel D bits 8, 3, K-bit
A4	TDFE0	Transmit bus channel F/E bit 0	Transmit bus channel E bits 5, 0
A5	TDFE2	Transmit bus channel F/E bit 2	Transmit bus channel E bits 7, 2
A6	TDFE4	Transmit bus channel F/E bit 4	Transmit bus channel E bits 9, 4
A7	TDFE6	Transmit bus channel F/E bit 6	Transmit bus channel F bits 6, 1
A8	TDFE8	Transmit bus channel F/E bit 8, K-bit	Transmit bus channel F bits 8, 3, K-bit
A9	TDHG0	Transmit bus channel H/G bit 0	Transmit bus channel G bits 5, 0
A10	TDHG2	Transmit bus channel H/G bit 2	Transmit bus channel G bits 7, 2
A11	TDHG4	Transmit bus channel H/G bit 4	Transmit bus channel G bits 9, 4
A12	TDHG6	Transmit bus channel H/G bit 6	Transmit bus channel H bits 6, 1
A13	TDHG8	Transmit bus channel H/G bit 8, K-bit	Transmit bus channel H bits 8, 3, K-bit
A14	GND A	Analog ground	
A15	TXH-	Channel H serial output -	
A16	TXH+	Channel H serial output +	
A17	GND A	Analog ground	
B1	TDDC2	Transmit bus channel D/C bit 2	Transmit bus channel C bits 7, 2
B2	TDDC5	Transmit bus channel D/C bit 5	Transmit bus channel D bits 5, 0
B3	TDDC9	Transmit bus channel D/C bit 9	Transmit bus channel D bits 9, 4
B4	TDFE1	Transmit bus channel F/E bit 1	Transmit bus channel E bits 6, 1
B5	TDFE3	Transmit bus channel F/E bit 3	Transmit bus channel E bits 8, 3, K-bit
B6	TDFE5	Transmit bus channel F/E bit 5	Transmit bus channel F bits 5, 0
B7	TDFE7	Transmit bus channel F/E bit 7	Transmit bus channel F bits 7, 2
B8	TDFE9	Transmit bus channel F/E bit 9	Transmit bus channel F bits 9, 4
B9	TDHG1	Transmit bus channel H/G bit 1	Transmit bus channel G bits 6, 1
B10	TDHG3	Transmit bus channel H/G bit 3	Transmit bus channel G bits 8, 3, K-bit
B11	TDHG5	Transmit bus channel H/G bit 5	Transmit bus channel H bits 5, 0
B12	TDHG7	Transmit bus channel H/G bit 7	Transmit bus channel H bits 7, 2
B13	TDHG9	Transmit bus channel H/G bit 9	Transmit bus channel H bits 9, 4
B14	GND A	Analog ground	
B15	TXG-	Channel G serial output-	
B16	TXG+	Channel G serial output+	
B17	GND A	Analog ground	
C1	TDDC0	Transmit bus channel D/C bit 0	Transmit bus channel C bits 5, 0
C2	TDDC1	Transmit bus channel D/C bit 1	Transmit bus channel C bits 6, 1
C3	TDDC6	Transmit bus channel D/C bit 6	Transmit bus channel D bits 6, 1
C4	TCLKD	Unused	Channels C and D transmit bus clock
C5	TCLKF	Unused	Channels E and F transmit bus clock
C6	TCLKH	Unused	Channels G and H transmit bus clock
C7	TDO	JTAG test data output	
C8	GE_MOD	Gigabit Ethernet mode	
C9	TDI	JTAG test data input	
C10	TCK	JTAG test clock	
C11	TMS	JTAG mode select	
C12	REFCLK	Reference clock	
C13	PRBSEN	2 ⁷ - 1 PRBS enable	
C14	GND A	Analog ground	

TLK2208B

8-PORT GIGABIT ETHERNET TRANSCEIVER

SLLS578E – AUGUST 2003 – REVISED MARCH 2009

TERMINAL NUMBER	TERMINAL FUNCTION	MULTIPLEXED CHANNEL MODE	NIBBLE INTERFACE SYNCHRONIZED AND INDEPENDENT CHANNEL MODES
C15	TXF-	Channel F serial output-	
C16	TXF+	Channel F serial output+	
C17	GNDA	Analog ground	
D1	TDBA0	Transmit bus channel B/A bit 0	Transmit bus channel A bits 5, 0
D2	TDBA1	Transmit bus channel B/A bit 1	Transmit bus channel A bits 6, 1
D3	TDDC7	Transmit bus channel D/C bit 7	Transmit bus channel D bits 7, 2
D4	NC	No connect	
D5	NC	No connect	
D6	NC	No connect	
D7	LPBK	Internal loopback enable	
D8	TRST	JTAG test reset	
D9	TCLKSEL	Multiplexed/independent clocking mode selection	
D10	NC	No connect	
D11	DVAD3	MDIO address LSB	
D12	DVAD4	MDIO address MSB	
D13	ENABLE	Device enable	
D14	GNDA	Analog ground	
D15	TXE-	Channel E serial output -	
D16	TXE+	Channel E serial output +	
D17	GNDA	Analog ground	
E1	TDBA2	Transmit bus channel B/A bit 2	Transmit bus channel A bits 7, 2
E2	TDBA3	Transmit bus channel B/A bit 3	Transmit bus channel A bits 8, 3, K-bit
E3	TCLKB	Transmit bus clock	
E4	GND	Core ground	
E5	VDDQ	I/O voltage supply	
E6	VDDQ	I/O voltage supply	
E7	VDDQ	I/O voltage supply	
E8	VDDQ	I/O voltage supply	
E9	VDDQ	I/O voltage supply	
E10	VDD	Core voltage supply	
E11	VDD	Core voltage supply	
E12	VDD	Core voltage supply	
E13	VDDA	I/O voltage supply	
E14	GNDA	Analog ground	
E15	TXD-	Channel D serial output -	
E16	TXD+	Channel D serial output +	
E17	GNDA	Analog ground	
F1	TDBA4	Transmit bus channel B/A bit 4	Transmit bus channel A bits 9, 4, K-bit
F2	TDBA5	Transmit bus channel B/A bit 5	Transmit bus channel B bits 5, 0
F3	RSVD	Reserved—should be left unconnected	
F4	GND	Core ground	
F5	VDDQ	I/O voltage supply	
F6	T-GND	Thermal ground	
F7	T-GND	Thermal ground	
F8	T-GND	Thermal ground	
F9	T-GND	Thermal ground	

TLK2208B

8-PORT GIGABIT ETHERNET TRANSCEIVER

SLLS578E – AUGUST 2003 – REVISED MARCH 2009

TERMINAL NUMBER	TERMINAL FUNCTION	MULTIPLEXED CHANNEL MODE	NIBBLE INTERFACE SYNCHRONIZED AND INDEPENDENT CHANNEL MODES
F10	T-GND		Thermal ground
F11	T-GND		Thermal ground
F12	T-GND		Thermal ground
F13	VDDA		Analog voltage supply
F14	GNDA		Analog ground
F15	TXC-		Channel C serial output -
F16	TXC+		Channel C serial output +
F17	GNDA		Analog ground
G1	TDBA6	Transmit bus channel B/A bit 6	Transmit bus channel B bits 6, 1
G2	TDBA7	Transmit bus channel B/A bit 7	Transmit bus channel B bits 7, 2
G3	RESET		Device reset
G4	GND		Core ground
G5	VDDQ		I/O voltage supply
G6	T-GND		Thermal ground
G7	T-GND		Thermal ground
G8	T-GND		Thermal ground
G9	T-GND		Thermal ground
G10	T-GND		Thermal ground
G11	T-GND		Thermal ground
G12	T-GND		Thermal ground
G13	VDDA		Analog voltage supply
G14	GNDA		Analog ground
G15	TXB-		Channel B serial output -
G16	TXB+		Channel B serial output +
G17	GNDA		Analog ground
H1	TDBA8	Transmit bus channel B/A bit 8, K bit	Transmit bus channel B bits 8, 3, K-bit
H2	TDBA9	Transmit bus channel B/A bit 9	Transmit bus channel B bits 9, 4
H3	MDC		MDIO Clock
H4	GND		Core ground
H5	VDDQ		I/O voltage supply
H6	T-GND		Thermal ground
H7	T-GND		Thermal ground
H8	T-GND		Thermal ground
H9	T-GND		Thermal ground
H10	T-GND		Thermal ground
H11	T-GND		Thermal ground
H12	T-GND		Thermal ground
H13	VDDA		Analog voltage supply
H14	GNDA		Analog ground
H15	TXA-		Channel A serial output -
H16	TXA+		Channel A serial output +
H17	GNDA		Analog ground
J1	MDIO		MDIO data I/O
J2	CODE		8b/10b enable
J3	CV_DIS_EN		Code violation enable
J4	GND		Core ground

TLK2208B

8-PORT GIGABIT ETHERNET TRANSCEIVER

SLLS578E – AUGUST 2003 – REVISED MARCH 2009

TERMINAL NUMBER	TERMINAL FUNCTION	MULTIPLEXED CHANNEL MODE	NIBBLE INTERFACE SYNCHRONIZED AND INDEPENDENT CHANNEL MODES
J5	VDDQ	I/O voltage supply	
J6	T-GND	Thermal ground	
J7	T-GND	Thermal ground	
J8	T-GND	Thermal ground	
J9	T-GND	Thermal ground	
J10	T-GND	Thermal ground	
J11	T-GND	Thermal ground	
J12	T-GND	Thermal ground	
J13	VDDA	Analog voltage supply	
J14	NC	No connect	
J15	NC	No connect	
J16	GND A	Analog ground	
J17	GND A	Analog ground	
K1	RDBA0	Receive bus channel B/A bit 0	Receive bus channel A bits 5, 0
K2	RDBA1	Receive bus channel B/A bit 1	Receive bus channel A bits 6, 1
K3	NC	No connect	
K4	GND	Core ground	
K5	VDDQ	I/O voltage supply	
K6	T-GND	Thermal ground	
K7	T-GND	Thermal ground	
K8	T-GND	Thermal ground	
K9	T-GND	Thermal ground	
K10	T-GND	Thermal ground	
K11	T-GND	Thermal ground	
K12	T-GND	Thermal ground	
K13	VDDA	Analog voltage supply	
K14	GND A	Analog ground	
K15	RXH-	Channel H serial input -	
K16	RXH+	Channel H serial input +	
K17	GND A	Analog ground	
L1	RDBA2	Receive bus channel B/A bit 2	Receive bus channel A bits 7, 2
L2	RDBA3	Receive bus channel B/A bit 3	Receive bus channel A bits 8, 3, K-bit
L3	NC	No connect	
L4	GND	Core ground	
L5	VDDQ	I/O voltage supply	
L6	T-GND	Thermal ground	
L7	T-GND	Thermal ground	
L8	T-GND	Thermal ground	
L9	T-GND	Thermal ground	
L10	T-GND	Thermal ground	
L11	T-GND	Thermal ground	
L12	T-GND	Thermal ground	
L13	VDDA	Analog voltage supply	
L14	GND A	Analog ground	
L15	RXG-	Channel G serial input -	
L16	RXG+	Channel G serial input +	

TLK2208B

8-PORT GIGABIT ETHERNET TRANSCEIVER

SLLS578E – AUGUST 2003 – REVISED MARCH 2009

TERMINAL NUMBER	TERMINAL FUNCTION	MULTIPLEXED CHANNEL MODE	NIBBLE INTERFACE SYNCHRONIZED AND INDEPENDENT CHANNEL MODES
L17	GNDA	Analog ground	
M1	RDBA4	Receive bus channel B/A bit 4	Receive bus channel A bits 9, 4
M2	RDBA5	Receive bus channel B/A bit 5	Receive bus channel B bits 5, 0
M3	NC	No connect	
M4	GND	Core ground	
M5	VDDQ	I/O voltage supply	
M6	T-GND	Thermal ground	
M7	T-GND	Thermal ground	
M8	T-GND	Thermal ground	
M9	T-GND	Thermal ground	
M10	T-GND	Thermal ground	
M11	T-GND	Thermal ground	
M12	T-GND	Thermal ground	
M13	VDDA	Analog voltage supply	
M14	GNDA	Analog ground	
M15	RXF-	Channel F serial input-	
M16	RXF+	Channel F serial input+	
M17	GNDA	Analog ground	
N1	RDBA6	Receive bus channel B/A bit 6	Receive bus channel B bits 6, 1
N2	RDBA7	Receive bus channel B/A bit 7	Receive bus channel B bits 7, 2
N3	NC	No connect	
N4	GND	Core ground	
N5	VDDQ	I/O voltage supply	
N6	VDDQ	I/O voltage supply	
N7	VDDQ	I/O voltage supply	
N8	VDDQ	I/O voltage supply	
N9	VDDQ	I/O voltage supply	
N10	VDD	Core voltage supply	
N11	VDD	Core voltage supply	
N12	VDD	Core voltage supply	
N13	VDDA	Analog voltage supply	
N14	GNDA	Analog ground	
N15	RXE-	Channel E serial input -	
N16	RXE+	Channel E serial input +	
N17	GNDA	Analog ground	
P1	RDBA8	Receive bus channel B/A bit 8, K-flag	Receive bus channel B bits 8, 3, K-flag
P2	RDBA9	Receive bus channel B/A bit 9	Receive bus channel B bits 9, 4
P3	RDDC7	Receive bus channel D/C bit 7	Receive bus channel D bits 7, 2
P4	RBCA	Unused	Channel A receive clock
P5	NC	No connect	
P6	NC	No connect	
P7	RSVD	Reserved—should be left unconnected	
P8	RSVD	Reserved—should be left unconnected	
P9	BUSYEN	Busy enable	
P10	RSVD	Reserved—should be left unconnected	
P11	MODE0	Mode selector terminal	

TLK2208B 8-PORT GIGABIT ETHERNET TRANSCEIVER

SLLS578E – AUGUST 2003 – REVISED MARCH 2009

TERMINAL NUMBER	TERMINAL FUNCTION	MULTIPLEXED CHANNEL MODE	NIBBLE INTERFACE SYNCHRONIZED AND INDEPENDENT CHANNEL MODES
P12	MODE1	Mode selector terminal	
P13	NC	No connect	
P14	GNDA	Analog ground	
P15	RXD-	Channel D serial input -	
P16	RXD+	Channel D serial input +	
P17	GNDA	Analog ground	
R1	RDDC0	Receive bus channel D/C bit 0	Receive bus channel C bits 5, 0
R2	RDDC1	Receive bus channel D/C bit 1	Receive bus channel C bits 6, 1
R3	RDDC6	Receive bus channel D/C bit 6	Receive bus channel D bits 6, 1
R4	RBCB	Unused	Channel B receive clock
R5	RBCC	Unused	Channel C receive clock
R6	RBCD	Unused	Channel D receive clock
R7	RBCE	Unused	Channel E receive clock
R8	RBCF	Unused	Channel F receive clock
R9	RBCG	Unused	Channel G receive clock
R10	RCLK RBCH	Receive clock	Receive clock
R11	PLL_LOCK	Transmits PLLs-locked indicator	
R12	NC	No connect	
R13	NC	No connect	
R14	GNDA	Analog ground	
R15	RXC-	Channel C serial input -	
R16	RXC+	Channel C serial input +	
R17	GNDA	Analog ground	
T1	RDDC2	Receive bus channel D/C bit 2	Receive bus channel C bits 7, 2
T2	RDDC5	Receive bus channel D/C bit 5	Receive bus channel D bits 5, 0
T3	RDDC9	Receive bus channel D/C bit 9	Receive bus channel D bits 9, 4
T4	RDFE1	Receive bus channel F/E bit 1	Receive bus channel E bits 6, 1
T5	RDFE3	Receive bus channel F/E bit 3	Receive bus channel E bits 8, 3, K-flag
T6	RDFE5	Receive bus channel F/E bit 5	Receive bus channel F bits 5, 0
T7	RDFE7	Receive bus channel F/E bit 7	Receive bus channel F bits 7, 2
T8	RDFE9	Receive bus channel F/E bit 9	Receive bus channel F bits 9, 4
T9	RDHG1	Receive bus channel H/G bit 1	Receive bus channel G bits 6, 1
T10	RDHG3	Receive bus channel H/G bit 3	Receive bus channel G bits 8, 3, K-flag
T11	RDHG5	Receive bus channel H/G bit 5	Receive bus channel H bits 5, 0
T12	RDHG7	Receive bus channel H/G bit 7	Receive bus channel H bits 7, 2
T13	RDHG9	Receive bus channel H/G bit 9	Receive bus channel H bits 9, 4
T14	GNDA	Analog ground	
T15	RXB-	Channel B serial input -	
T16	RXB+	Channel B serial input +	
T17	GNDA	Analog ground	
U1	RDDC3	Receive bus channel D/C bit 3	Receive bus channel C bits 8, 3, K-flag
U2	RDDC4	Receive bus channel D/C bit 4	Receive bus channel C bits 9, 4
U3	RDDC8	Receive bus channel D/C bit 8, K flag	Receive bus channel D bits 8, 3, K-flag
U4	RDFE0	Receive bus channel F/E bit 0	Receive bus channel E bits 5, 0
U5	RDFE2	Receive bus channel F/E bit 2	Receive bus channel E bits 7, 2
U6	RDFE4	Receive bus channel F/E bit 4	Receive bus channel E bits 6, 4

TLK2208B

8-PORT GIGABIT ETHERNET TRANSCEIVER

SLLS578E – AUGUST 2003 – REVISED MARCH 2009

TERMINAL NUMBER	TERMINAL FUNCTION	MULTIPLEXED CHANNEL MODE	NIBBLE INTERFACE SYNCHRONIZED AND INDEPENDENT CHANNEL MODES
U7	RDFE6	Receive bus channel F/E bit 6	Receive bus channel F bits 6, 1
U8	RDFE8	Receive bus channel F/E bit 8, K flag	Receive bus channel F bits 8, 3, K-flag
U9	RDHG0	Receive bus channel H/G bit 0	Receive bus channel G bits 5, 0
U10	RDHG2	Receive bus channel H/G bit 2	Receive bus channel G bits 7, 2
U11	RDHG4	Receive bus channel H/G bit 4	Receive bus channel G bits 9, 4
U12	RDHG6	Receive bus channel H/G bit 6	Receive bus channel H bits 6, 1
U13	RDHG8	Receive bus channel H/G bit 8, K flag	Receive bus channel H bits 8, 3, K-flag
U14	GNDA	Analog ground	
U15	RXA-	Channel A serial input -	
U16	RXA+	Channel A serial input +	
U17	GNDA	Analog ground	

detailed description

reference clock synthesizer

The TLK2208B employs a mature phase-lock loop (PLL) design in use for Gigabit Ethernet transceivers and high-speed serial links by Texas Instruments since 1997 on both standard products and custom ASIC designs. This PLL design is used to synthesize the serial line-rate bit clock from the REFCLK input as well as generate clocks for the receiver sampling circuitry. The PLL and associated high-speed circuitry are powered by the analog power supply terminals (VDDA) with isolated grounds (GNDA). Care should be taken in providing a low-noise environment in a system. It is recommended to supply the VDDA reference by a separate isolated plane within the system printed-circuit board (PCB). It is recommended that systems employing switching power supplies provide proper filtering of the fundamental and harmonic components in the 2-MHz–10-MHz band to avoid bit errors from injected noise. It is strongly recommended that no PLL-based clock synthesizer circuit be used as the source for the REFCLK. This could cause accumulation of jitter between the two PLLs.

operating modes

The TLK2208B has two operational modes selectable via the CODE terminal, as detailed in Table 1.

Table 1. Operational Modes

CODE	OPERATING MODES
Low	SERDES mode. On-chip 8b/10b encoder/decoder is disabled. Refer to the <i>byte alignment logic</i> section, for additional description on control over this mode.
High	Transceiver mode. Enables 8b/10b encode/decode for each channel. Data on the transmit and receive data buses is treated as uncoded data. The K-generator bit is used as the K-character generator control. The K-flag is the K-character indicator to the host device.

NOTE: The logic value of the code terminal is ORed with MDIO register 17.7 (8B/10B_EN).

In SERDES mode, the transmit data bus for each channel accepts 10-bit-wide data on the transmit data channel terminals. Data is latched on the rising and falling edges of the transmit data clock. The data is then phase-aligned, serialized, and transmitted sequentially beginning with bit 0 over the differential high-speed serial transmit terminals. The receive data bus for each channel outputs 10-bit data. Data is output relative to both the rising and falling edges of the receive clock.

In transceiver mode, the transmit data bus for each channel accepts 8-bit-wide parallel data. Data is sampled on the rising and falling edges of the transmit clock. The data is first aligned to the reference clock (REFCLK), then 8b/10b encoded and passed to the serializer. The generation of K-characters on each channel is controlled by the K-generator bit (see the *parallel interface modes* section). When the K-generator bit is asserted along with the 8 bits of data, the appropriate 8b/10b K-character is transmitted. The receive data bus for each channel

outputs 8-bit-wide parallel data. Reception of K-characters is reported on the K-flag bit (see the *parallel interface modes* section). When the K-flag of any channel is asserted, the 8 bits of data on that channel's receive data bus should be interpreted as a K-character.

When CV_DIS_EN is high, the outputs RDxx[8:0] are set to 1 when a code violation or RD error is detected.

When CV_DIS_EN is low, the outputs RDxx[7:0] are set to 1 when a code violation is detected. An RD error is not indicated in this case.

parallel interface modes

The TLK2208B provides two basic operational interface modes controlled by the state of terminals MODE0 and MODE1. The internal state of these mode terminals can be controlled via MDIO to change the modes of operation. These operational interface modes are listed in Table 2.

Table 2. Parallel Interface Modes

MODE1	MODE2	OPERATING MODES
Low	Low	Multiplexed channel mode
Low	High	Reserved
High	Low	Nibble interface channel mode
High	High	Reserved

NOTE: MODE terminals can be overridden via MDIO register 17.6 (MODE_OVR).

Regardless of MODE settings, the channels can be operated in synchronous mode or independent mode. The channels are operated in synchronous mode when the TCLKSEL terminal (or MDIO register 17.15) is set to a logic low (default). If either the terminal or the MDIO register is set to a logic high, the channels are operated in independent mode. See the *serializer* section for further details.

The clock tolerance compensation, (see the *clock tolerance compensation (CTC)* section), is enabled by default and must not be disabled via MDIO while in the multiplexed channel mode.

transmit logic

The transmit logic converts parallel data into an NRZ serial bit stream with a differential VML output at 1.0–1.3 Gbps, dependent on REFCLK and TCLKx frequency. The input to the transmitter can be either an 8-bit parallel word plus a control (K) bit, or a 10-bit word.

transmit clock interface

The TLK2208B provides two transmit clocking modes as summarized in Table 3. In synchronous channel mode, all input data for all channels is timed from a single input clock, TCLKB. In independent channel mode, four clocks are used; input data for each pair of channels is timed with one of these clocks.

In synchronous channel mode, data to be transmitted is latched by both the rising and falling edges of TCLKB. TCLKB must be frequency synchronous with REFCLK (0 ppm), but may have any phase relationship with respect to REFCLK.

In independent channel mode, input data for channels A and B is referenced from TCLKB. Input data for channels C and D is referenced from TCLKD. Input data for channels E and F is referenced from TCLKF, and lastly input data from channels G and H is referenced from TCLKH. TCLKB, TCLKD, TCLKF and TCLKH are expected to be the same frequency as the reference clock, REFCLK, but of arbitrary phase.

TLK2208B
8-PORT GIGABIT ETHERNET TRANSCEIVER

SLLS578E – AUGUST 2003 – REVISED MARCH 2009

Table 3. Independent vs Synchronous Mode

TCLKSEL (TERMINAL)	TransClkMode MDIO REGISTER 17.15	OPERATING MODE
Low	Low	Synchronous channel mode
Don't Care	High	Independent channel mode
High	Don't Care	Independent channel mode

transmit logic (continued)

transmit parallel interface

The TLK2208B provides source-centered interface to the MAC.

In multiplexed channel mode, channels A and B, C and D, E and F, and G and H are each interleaved on the same 10-bit bus. Channels B, D, F, H are input referenced to the rising edge of TCLKx. Channels A, C, E, and G are input referenced to the falling edge of TCLKB (see Figure 4).

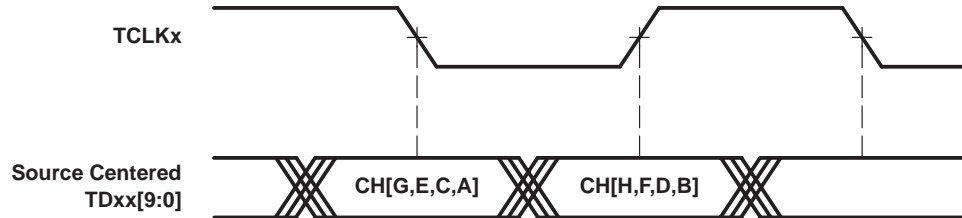

Figure 4. Multiplexed Channel Transmit Timing Options

In the nibble interface mode, channels B, D, F, and H are input on high-order nibble TDxx[9:5], while channels A, C, E, G are input on low-order nibble TDxx[4:0], as shown in Figure 5. **Note:** In the transmit direction, channel pairs (A/B, C/D, E/F, G/H) have a common transmit clock and DDR input register bank. As a result, software assertion of the Channel A TX_SwRST MDIO register will temporarily corrupt Channel B data (until the software reset ends). Channel C TX_SwRST causes the same data corruption on Channel D. Channel E TX_SwRST causes the same data corruption on Channel F. Channel G TX_SwRST causes the same data corruption on Channel H.

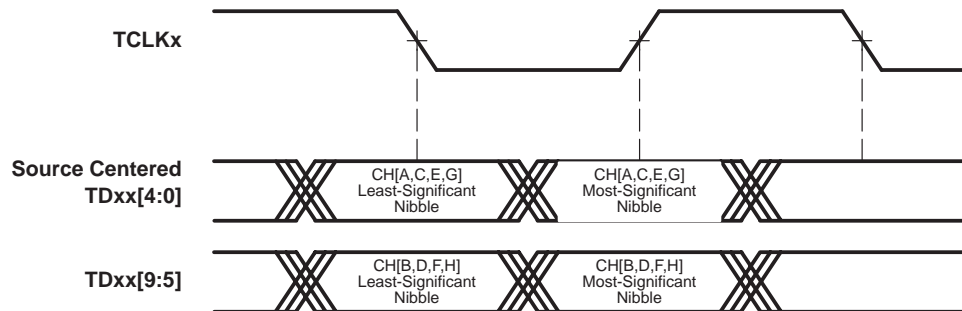

Figure 5. Nibble Mode Transmit Timing Options

TLK2208B

8-PORT GIGABIT ETHERNET TRANSCEIVER

SLLS578E – AUGUST 2003 – REVISED MARCH 2009

transmit logic (continued)

8b/10b encoder

All true serial interfaces require a method of encoding to ensure sufficient transition density for the receiving PLL to acquire and maintain lock. The encoding scheme also maintains the signal dc balance by keeping the number of 1s and 0s the same, which allows for ac-coupled data transmission. The TLK2208B uses the 8b/10b encoding algorithm that is used by the Fibre Channel and Gigabit Ethernet specifications. This provides good transition density for clock recovery and improves error checking. The 8b/10b encoder/decoder function is enabled for all channels by the assertion of the CODE terminal. When enabled, the TLK2208B internally encodes and decodes the data such that the user actually reads and writes 8-bit data on each channel.

When enabled (CODE = high), the 8b/10b encoder converts 8-bit-wide data to a 10-bit-wide encoded data character to improve its transition density. This transmission code includes D-characters, used for transmitting data, and K-characters, used for transmitting protocol information. Each K- or D-character code word can also have either a positive or a negative disparity version. The disparity of a code word is selected by the encoder to balance the running disparity of the serialized data stream.

The generation of K-characters to be transmitted on each channel is controlled by TDxx8 when in the multiplexed channel mode. When these terminals are asserted along with the 8 bits of data, an 8b/10b K-character is transmitted. Similarly, reception of K-characters is reported by RDxx8. When RDxx8 is asserted, the 8 bits of data on RDxx should be interpreted as a K-character. The TLK2208B transmits and receives all 12 of the valid K-characters defined in the Fibre Channel and Gigabit Ethernet specifications. Invalid data patterns input when TDxx8 is asserted result in an invalid K-character being transmitted, which results in a code error at the receiver.

serializer

The parallel-to-serial shift register on each channel takes in 10-bit-wide data from either the 8b/10b encoders, if enabled, or directly from the transmit data bus, and converts it to a serial stream. The shift register is clocked by the internally generated bit clock, which is 10 times the reference-clock (REFCLK) frequency. The least-significant bit (LSB) for each channel is transmitted first.

receive logic

The receiver input data must be ac-coupled and have a rate of 1.0–1.3 Gbps. Resistive termination to match 50-Ω traces is on-chip. The clock recovery circuitry retimes the input data by extracting a clock from the input data, and passes on the serial data and this recovered clock to the deserializer. Byte alignment is performed on K-characters per IEEE 802.3z (see the **byte alignment logic** section for details).

receive parallel interface

The receive data bus for all channels is output source centered with the bus clock in the center of the data eye, allowing direct connection to the protocol device.

In multiplexed channel and nibble interface synchronized channel modes, parallel data to be transferred to the protocol device is output referenced to both the rising and falling edges of RCLK. RCLK is frequency synchronous with REFCLK, but has no set phase relationship with respect to REFCLK.

In multiplexed channel mode, channels A and B, C and D, E and F, and G and H are each paired and interleaved on the same 10-bit bus. Channels B, D, F, H are output referenced to the rising edge of RCLK/RBCH and falling edge of RBCG (see Figure 6). Channels A, C, E, and G are output referenced to the falling edge of RCLK/RBCH and rising edge of RBCG. Remaining clocks RBCE–RBCF, RBCC–RBCD, and RBCE–RBCB are identical copies of RCLK/RBCH–RBCG and could be used as complementary clock pairs.

receive logic (continued)

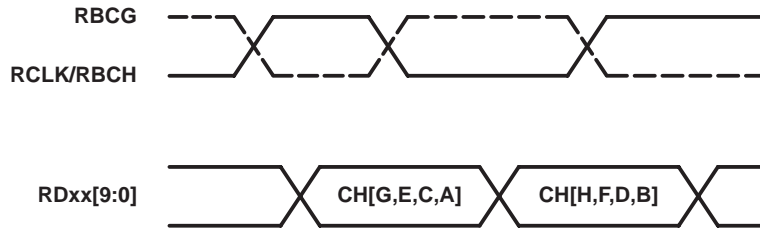

NOTE: RX timing is always source centered.

Figure 6. Multiplexed Channel Receive Timing

In the nibble interface channel mode, channels B, D, F, and H are output on the high-order nibble RDxx[9:5], while channels A, C, E, G are output on the low-order nibble RDxx[4:0] as shown in Figure 7.

In the nibble interface channel mode, parallel data to be transferred to the protocol device on channel A (RDBA[4:0]) is output referenced to both the rising and falling edges of RBCA, and channel B (RDBA[9:5]) is output referenced to both the rising and falling edges of RBCB. Channels C through H are output the same way with their respective clocks.

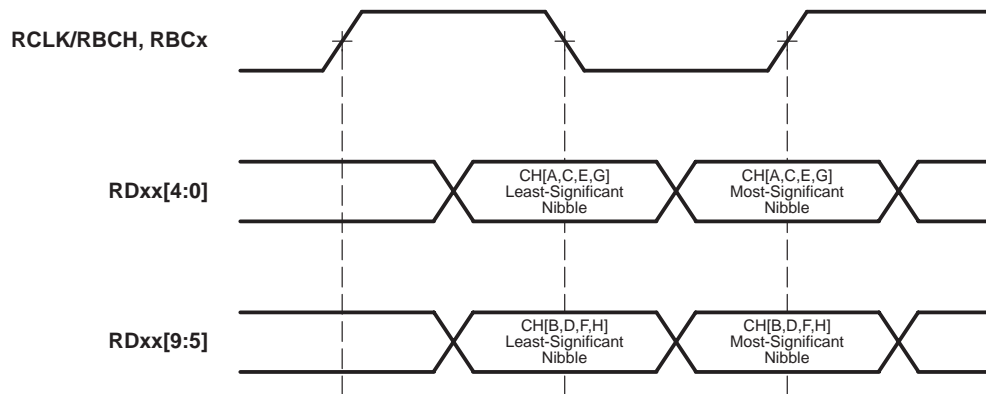

NOTE: RX timing is always source centered.

Figure 7. Nibble Mode Receive Timing

clock recovery

A baud-rate clock is extracted from the 10-bit encoded serial data stream independently on each channel. The receive clock locks to the input within 2 μ s after a valid input data stream is applied. The received data is deserialized and byte aligned. In the absence of input data, the clock recovery circuit locks onto the reference clock frequency REFCLK.

deserializer

For each channel, serial data is received on the RXx+/RXx- terminals. The interpolator and clock recovery circuit locks to the data stream if the clock to be recovered is within ± 100 ppm of the internally generated bit-rate clock. The recovered clock is used to retime the input data stream. The serial data is then clocked into the serial-to-parallel shift registers. If enabled, the 10-bit-wide parallel data is then fed into 8b/10b decoders. The parallel data for each channel is fed into a FIFO buffer where the output is synchronized to REFCLK.

TLK2208B

8-PORT GIGABIT ETHERNET TRANSCEIVER

SLLS578E – AUGUST 2003 – REVISED MARCH 2009

receive logic(continued)

clock tolerance compensation (CTC)

The TLK2208B compensates for the possibility that the incoming serial-data rate on any channel can be as much as 100 ppm faster or slower than the REFCLK frequency (± 100 ppm). Each channel independently and dynamically compensates for any frequency difference by the use of an elasticity buffer. If the incoming data rate is faster than the REFCLK frequency, the elasticity buffer fills. As it approaches the fill limit, it deletes or drops a 20-bit IDLE code^[1] found in the gap between Ethernet packets. If the incoming data rate is slower than the REFCLK, the elasticity buffer empties. As it approaches the empty limit, it adds or inserts a selectable 20-bit IDLE code found in the gap between Ethernet packets. IDLE code selection defaults to IDLE2, and can be changed to IDLE1 via MDIO. No running disparity is affected due to either the addition or the deletion of the IDLE code, as the IDLE code has a balanced number of 1s and 0s. Note that a deletion of a 20-bit IDLE code could reduce the inter-packet gap below the minimum inter-packet gap of 12 bytes (120 bits).

The CTC function adds or deletes IDLE codes only in the interpacket gap or during autonegotiation. Thus, the CTC FIFO depth is set to ensure that maximum size Ethernet packets (1540 bytes) can be received continuously at the frequency offset extremes without loss of data or synchronization. The CTC function can be disabled chip-wide via the MDIO registers.

When the CTC function is enabled, recovered clocks (RBCx) are buffered versions of the REFCLK.

When the CTC function is not enabled (nibble mode operation only), the recovered clocks for each channel are one tenth the rate of the clock recovered from the incoming stream.

byte alignment logic

Under default conditions, the TLK2208B uses the IEEE 802.3z-defined 10-bit K28.5 character (comma character, positive disparity) word alignment scheme^[2]. The following sections explain how this scheme works and how it realigns itself.

When parallel data is clocked into a parallel-to-serial converter, the byte boundary that was associated with the parallel data is lost in the serialization of the data. When the serial data is received and converted to parallel format again, a method is needed to be able to recognize the byte boundary again. Generally this is accomplished through the use of a synchronization pattern. This is a unique a pattern of 1s and 0s that either cannot occur as part of valid data or is a pattern that repeats at defined intervals. 8b/10b encoding contains a character called the comma (001 1111b), which is used by the comma-detect circuit to align the received serial data back to its original byte boundary. The decoder detects the K28.5 comma, generating a synchronization signal aligning the data to their 10-bit boundaries for decoding. It then converts the data back into 8-bit data. It is important to note that the comma can be either 001 1111b or the inverse, 110 0000b, depending on the running disparity. The TLK2208B decoder detects only the 001 1111b pattern. Therefore, since synchronization is achieved on the positive comma, two consecutive K-codes containing commas are required to ensure byte boundary synchronization (see Table 4).

During all operations, the TLK2208B receive clocks (RCLK, RBCx) are a constant duty cycle and frequency. There are no stretched or shortened clock pulses.

[1] IEEE 802.3z specifies an IDLE as a 20-bit code consisting of an IDLE1 code (/K28.5/D5.6/) and an IDLE2 code (/K28.5/D16.2/).

[2] Setting COMMA_DET = 0 by changing its value via MDIO 17.8 disables comma detection, and byte alignment takes place on any bit boundary; this permits external byte alignment on different bit sequences, and allows for the use of different bit-balancing algorithms.

receive logic(continued)

Table 4. Valid K-Characters

K-CHARACTER	RECEIVE DATA BUS (RDxx[7:0])	ENCODED K-CODE	
		NEGATIVE RUNNING DISPARITY	POSITIVE RUNNING DISPARITY
K28.0	0001 1100	00 1111 0100	11 0000 1011
K28.1	0011 1100	00 1111 1001 ^[1]	11 0000 0110
K28.2	0101 1100	00 1111 0101	11 0000 1010
K28.3	0111 1100	00 1111 0011	11 0000 1100
K28.4	1001 1100	00 1111 0010	11 0000 1101
K28.5	1011 1100	00 1111 1010 ^[1]	11 0000 0101
K28.6	1101 1100	00 1111 0110	11 0000 1001
K28.7	1111 1100	00 1111 1000 ^[1]	11 0000 0111
K23.7	1111 0111	11 1010 1000	00 0101 0111
K27.7	1111 1011	11 0110 1000	00 1001 0111
K29.7	1111 1101	10 1110 1000	01 0001 0111
K30.7	1111 1110	01 1110 1000	10 0001 0111

NOTE 1: A comma is contained within this K-code.

decoder and code violation logic

When the on-chip 8b/10b encoder/decoder is enabled (CODE = high), the reception of K-characters is reported by the assertion of RDxx8 on each channel. When a code-word error or running-disparity error is detected in the decoded data on a channel, RDxx[7:0] is asserted and is all 1s (0xFF).

control logic

MDIO management interface

The TLK2208B supports the management-data input/output (MDIO) interface as defined in Clause 22 of the IEEE 802.3 Ethernet specification. The MDIO allows register-based management and control of the serial links. Normal operation of the TLK2208B is possible without use of this interface because all of the essential signals necessary for operations are accessible via the device terminals. However, some additional features are accessible only through the MDIO.

The MDIO management interface consists of a bidirectional data path (MDIO) and a clock reference (MDC). The timing required to read from the internal registers is shown in Figure 8; the timing required to write to the internal registers is shown in Figure 9.

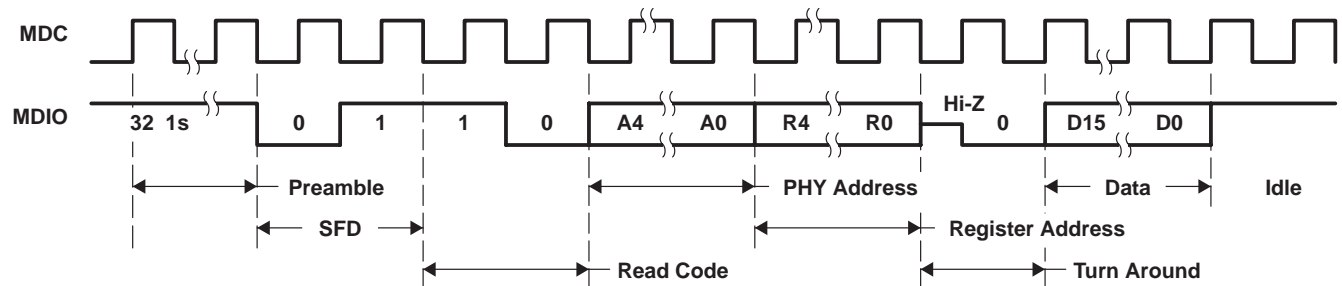

Figure 8. Management Interface Read Timing

TLK2208B 8-PORT GIGABIT ETHERNET TRANSCEIVER

SLLS578E – AUGUST 2003 – REVISED MARCH 2009

MDIO management interface (continued)

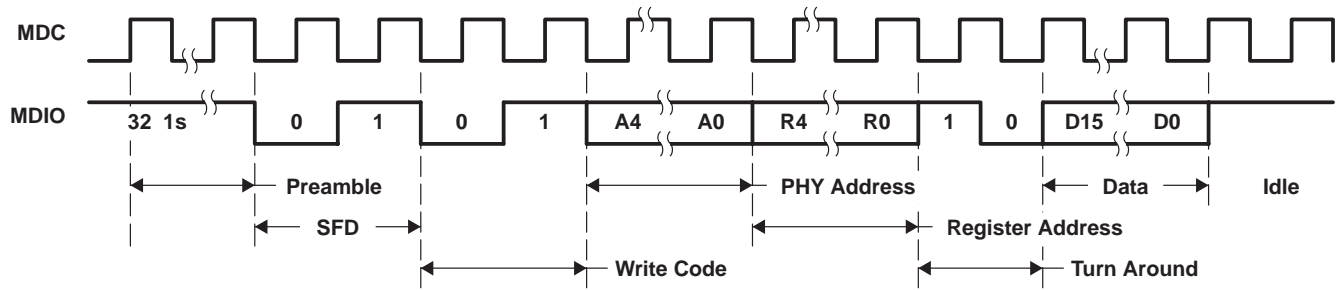

Figure 9. Management Interface Write Timing

The MDIO interface allows up to 32 (16-bit) internal registers. Sixteen registers are defined in Clause 22 of the IEEE 802.3 specification. Additional registers are allowed for expanded functionality. The TLK2208B implements five IEEE-defined registers. The TLK2208B also implements additional registers for expanded functionality. The IEEE-defined registers and the expanded functionality registers are outlined in Table 5.

Table 5. MDIO Registers

REGISTER ADDRESS	REGISTER NAME	DEFINITION
0	Control	IEEE 802.3-defined. See Table 6.
1	Status	IEEE 802.3-defined. See Table 7.
2,3	PHY identifier	IEEE 802.3-defined. See Table 8 and Table 9.
4–14	Not applicable	
15	Extended status	IEEE 802.3-defined. See Table 10.
16	Control register 0	Channel enable controls. See Table 11.
17	Control register 1	Various global controls. See Table 12.
18	Control register 2	Channels [A:B] preemphasis controls. See Table 13.
19	Control register 3	Channels [C:D] preemphasis controls. See Table 14.
20	Control register 4	Channels [E:F] preemphasis controls. See Table 15.
21	Control register 5	Channels [G:H] preemphasis controls. See Table 16.
22	Loopback control	Individual channel loopback controls. See. Table 17.
23	Reserved	Reserved control/status register. See Table 18.
24	Control register 6	Various global controls, preemphasis PRBS, CTC, busy. See Table 19.
25	Reserved	Reserved control/status register. See Table 20.
26	Status register 0	TI test individual channel status. See Table 21.
27	Status register 1	TI test individual channel status. See Table 22.
28	Status register 2	TI PRBS test status. See Table 23.
29	Status register 3	TI test register. See Table 24.
30	Test register 1	TI test control register. See Table 25.
31	Test register 2	TI test reserved register. See Table 26.

Table 6. Control Register (0x00) Bit Definitions

BIT(S)	DEFAULT VALUE = 0x0140	NAME	DESCRIPTION	READ/WRITE
0.15	0b	Reset	Logically ORed with the logic value of the RESET terminal. After the reset bit is set to one, it automatically sets itself back to zero on the next MDC clock cycle. 1 = Global resets including FIFO clear 0 = Normal operation (default)	Read/write, self-clearing
0.14	0b	Loopback	Logically ORed with the logic value of the LPBK terminal 1 = Enable loopback mode on all channels 0 = Disable loopback mode on all channels (default)	Read/write
0.13	0b	Speed selection (LSB)	Not applicable. Read returns a 0.	Read-only, See Note 2
0.12	0b	Auto-negotiation enable	Not applicable. Read returns a 0.	Read-only, See Note 2
0.11	0b	Power down	Setting this bit high powers down the device, with the exception that the MDIO interface stays active. 1 = Power-down mode is enabled 0 = Normal operation (default)	Read/write
0.10	0b	Isolate	Not applicable. Read returns a 0.	Read-only, See Note 2
0.9	0b	Restart auto-negotiation	Not applicable. Read returns a 0.	Read-only, See Note 2
0.8	1b	Duplex mode	Only full duplex is supported, Write is ignored, read returns a 1.	Read-only, See Note 2
0.7	0b	Collision test	Not applicable. Read returns a 0.	Read-only, See Note 2
0.6	1b	Speed selection (MSB)	Not applicable. Read returns a 1.	Read-only, See Note 2
0.5:0	00 0000b	Reserved	Read returns 0s, write is ignored.	Read-only, See Note 2

NOTE 2: Writing to this bit position is ignored.

Table 7. Status Register (0x01) Bit Definitions

BIT(S)	DEFAULT VALUE = 0x0101	NAME	DESCRIPTION	READ/WRITE
1.15:9	0000 000b		Read returns a 0.	Read-only
1.8	1b	Extended status	Read returns a 1, indicating extended status information is held in register 0x0F.	Read-only
1.7	0b	Reserved	Read returns a 0.	Read-only
1.6:3	0b	Various configurations	Read returns a 0.	Read-only
1.2	0b	Link status	Read returns a 0.	Read-only
1.1	0b	Jabber detect	Read returns a 0.	Read-only
1.0	1b	Extended capability	Read returns a 1, indicating extended register capability.	Read-only

The identifier code is composed of bits 3–24 of the 25-bit organizationally unique identifier (OUI) assigned to Texas Instruments by the IEEE. The 6-bit manufacturer model number is unique to the TLK2208B. The manufacturer revision number denotes the current revision of the TLK2208B. See Table 8 and Table 9.

TLK2208B
8-PORT GIGABIT ETHERNET TRANSCEIVER

SLLS578E – AUGUST 2003 – REVISED MARCH 2009

Table 8. PHY ID0 Identifier (0x02) Bit Definitions

OUI ADDRESS BITS 3–18															
2.15	2.14	2.13	2.12	2.11	2.10	2.9	2.8	2.7	2.6	2.5	2.4	2.3	2.2	2.1	2.0
0	1	0	0	0	0	0	0	0	0	0	0	0	0	0	0

Table 9. PHY ID1 Identifier (0x03) Bit Definitions

OUI ADDRESS BITS 19–24						MANUFACTURER MODEL NUMBER						MANUFACTURER REVISION NUMBER			
3.15	3.14	3.13	3.12	3.11	3.10	3.9	3.8	3.7	3.6	3.5	3.4	3.3	3.2	3.1	3.0
0	1	0	1	0	0	0	0	0	0	1	0	0	0	0	1

Table 10. Extended Status Register (0x0F) Bit Definitions

BIT(S)	DEFAULT VALUE = 0x0000	NAME	DESCRIPTION	READ/WRITE
15.15:12	0h	Various configurations	Read returns 0s; write is ignored.	Read-only
15.11:0	000h	Reserved	Read returns 0s; write is ignored.	Read-only

Table 11. Control Register 0 (0x10) Bit Definitions

BIT(S)	DEFAULT VALUE = 0xFF00	NAME	DESCRIPTION	READ/WRITE
16.15:8	FFh	CH_Enable[H:A]	Channel enable (active high). These bits enable each channel individually. These bits are initialized to 0xFF when reset. These register bits are ANDed with the logic value of the ENABLE terminal.	Read/write, See Note 3
16.7:0	00h	Reserved	Read returns 0s; write is ignored.	Read-only

NOTE 3: Dynamic changes to these register bits might affect other active ports in operation.

Table 12. Control Register 1 (0x11) Bit Definitions

BIT(S)	DEFAULT VALUE= 0x4380	NAME	DESCRIPTION	READ/WRITE
17.15	0b	TransClkMode	A logic 0 sets all channels synchronous to TCLKB, a logic 1 sets individual clocking. This register bit is logically ORed with the logic value of the TCLKSEL input terminal.	Read/write
17.14	1b	CVDispEn	Code-violation and disparity-error global enable. This bit is logically ORed with the logic value of the CV_DIS_EN terminal.	Read/write
17.13:10	0000b	Reserved	Read returns a 0; write is ignored.	
17.9	1b	OUT_EN	Global internal parallel output enable (enable = 1). This bit is ANDed with the logic value of the ENABLE terminal.	Read/write
17.8	1b	COMMA_DET	Enables comma detect global enable for channel alignment	Read/write
17.7	1b	8B/10B_EN	Global 8b/10b enable (logically ORed with the logic value of the CODE terminal)	Read/write
17.6	0b	MODE_OVR	If set to a logic 1, it permits mode override.	Read/write
17.5:4	00b	MODE[1:0]	If MODE_OVR is set, permits override of external terminals for mode setting	Read/write
17.3	0b	S_RESET	Soft reset (active high). This bit resets all logic in the receive and transmit sections and in the FIFO. Note that the desertion sequence of the reset bits is critical to achieving deterministic operation. Performs similarly to the RESET terminal but does not reset MDIO registers.	Read/write, Self-clearing, See Note 4
17.2:0	000b	Reserved	Read returns 0s; write is ignored.	Read-only

NOTE 4: After the S_RESET bit is set to 1, it automatically sets itself back to 0 on the next MDC clock cycle.

Table 13. Control Register 2 (0x12) Bit Definitions

BIT(S)	DEFAULT VALUE = 0x0DBC	NAME	DESCRIPTION	READ/WRITE
18.15:12	0h	Reserved	Read returns 0s; write is ignored.	Read-only
18.11:10	11b	PreEmpAB[1:0]	Preemphasis control, channels A and B [00] No preemphasis [01] Low preemphasis [10] Mid preemphasis [11] High preemphasis	Read/write
18.9	0b	EdgeOvrCtlAB	Overrides global preemphasis settings for channels A and B when asserted	Read/write
18.8:0	1 1011 1100b	IDLE1[8:0]	First IDLE character. Default is K28.5.	Read/write

Table 14. Control Register 3 (0x13) Bit Definitions

BIT(S)	DEFAULT VALUE = 0x0C50	NAME	DESCRIPTION	READ/WRITE
19.15:12	0h	Reserved	Read returns 0s; write is ignored.	Read-only
19.11:10	11b	PreEmpCD[1:0]	Preemphasis control, channels C and D [00] No preemphasis [01] Low preemphasis [10] Mid preemphasis [11] High preemphasis	Read/write
19.9	0b	EdgeOvrCtlCD	Overrides global preemphasis settings for channels C and D when asserted	Read/write
19.8:0	0 0101 0000b	IDLE2[8:0]	Second IDLE character. Default is D16.2.	Read/write

TLK2208B

8-PORT GIGABIT ETHERNET TRANSCEIVER

SLLS578E – AUGUST 2003 – REVISED MARCH 2009

Table 15. Control Register 4 (0x14) Bit Definitions

BIT(S)	DEFAULT VALUE = 0x0DBC	NAME	DESCRIPTION	READ/WRITE
20.15:12	0h	Reserved	Read returns 0s; write is ignored.	Read-only
20.11:10	11b	PreEmpEF[1:0]	Preemphasis control, channels E and F [00] No preemphasis [01] Low preemphasis [10] Mid preemphasis [11] High preemphasis	Read/write
20.9	0b	EdgeOvrCtlEF	Overrides global preemphasis settings for channels E and F when asserted	Read/write
20.8:0	1 1011 1100b	IDLE1a[8:0]	First alternate IDLE character. Default is K28.5.	Read/write

Table 16. Control Register 5 (0x15) Bit Definitions

BIT(S)	DEFAULT VALUE = 0x0C50	NAME	DESCRIPTION	READ/WRITE
21.15:12	0h	Reserved	Read returns 0s; write is ignored.	Read-only
21.11:10	11b	PreEmpGH[1:0]	Preemphasis control, channels G and H [00] No preemphasis [01] Low preemphasis [10] Mid preemphasis [11] High preemphasis	Read/write
21.9	0b	EdgeOvrCtlGH	Overrides global preemphasis settings for channels G and H when asserted	Read/write
21.8:0	0 0101 0000b	IDLE2a[8:0]	Second alternate IDLE character. Default is K16.2.	Read/write

Table 17. Loopback Control Register (0x16) Bit Definitions

BIT(S)	DEFAULT VALUE = 0x0000	NAME	DESCRIPTION	READ/WRITE
22.15:8	00h	LOOPBACK[H:A]	Serial loopback enable (active high) When asserted high, TX[9:0] data is looped back to RX[9:0], utilizing the value of the CODE (and 8B/10B_EN) selection to steer the data path. The serial transmit outputs are held in the high-impedance state and the serial inputs are ignored. All bits are logically ORed with the logic value of the LPBK terminal.	Read/write
22.7:0	00h	SLOOPBACK[H:A]	Far end loopback enable (active high) channels H:A. Input is received at RX+/RX- inputs, deserialized and steered to transmit path, and serialized to TX+/TX- outputs. Note: This is only valid for channel pairs A and B, C and D, E and F and G and H.	Read/write

Table 18. Control Register (0x17) Bit Definitions

BIT(S)	DEFAULT VALUE = 0x0C50	NAME	DESCRIPTION	READ/WRITE
23.15:0	0000h	Reserved	Read returns 0s.	Read-only

Table 19. Control Register 6 (0x18) Bit Definitions

BIT(S)	DEFAULT VALUE = 0x100C	NAME	DESCRIPTION	READ/WRITE
24.15	0b	GEMODE	Gigabit Ethernet mode. When set to 1: – Treats /K28.5/ followed by any non-K character as an IDLE sequence (except when BMOD is asserted, chip treats /K28.5/D10.1/ as described in the BMOD terminal description). – Modifies IDLE to correct disparity by substituting /D5.6/ for /D15.2/ in a /K28.5/Dx.y/ transmit IDLE pair. This bit is logically ORed with the logic value of the GE_MOD terminal.	Read/write
24.14	0b	BusyMode	If set to a logic 1, causes /K28.5/D10.1/ to be treated as data and passed through FIFO. If set to a logic 0, causes sequence to be treated as IDLE. This bit is ORed with the logic value of the BUSYEN terminal. This condition is valid only when the GEMODE bit or GE_MOD terminal is at a logic 1.	Read/write
24.13	0b	Reserved	Read returns a 0; write is ignored.	Read-only
24.12	1b	CTC_EN	Global CTC enable	Read/write
24.11.10	00b	Reserved	Read returns 0s; write is ignored.	Read-only
24.9	0b	PRBS_VE	Global enable for all internal RX PRBS verification. Results can be observed in MDIO register 0x1F[15:8].	Read/write
24.8	0b	PRBS_EN	Enable global PRBS sequences. Results are observable on RDxx[9:0] busses, and TX+/TX- SERDES outputs. Results can be observed on the MDIO test register (0x1F[7:0]).	Read/write
24.7:4	0h	Reserved	Read returns 0s; write is ignored.	Read-only
24.3:2	11b	PREEMP[1:0]	Global preemphasis controls [00] No preemphasis [01] Low preemphasis [10] Mid preemphasis [11] High preemphasis	Read/write
24.1:0	00b	Reserved	Read returns 0s, write is ignored.	Read/write

Table 20. Reserved (0x19) Bit Definitions

BIT(S)	DEFAULT VALUE = 0x0000	NAME	DESCRIPTION	READ/WRITE
25.15:0	0000h	Reserved	Read returns 0s.	Read-only

Table 21. Status Register 0 (0x1A) Bit Definitions

BIT(S)	DEFAULT VALUE = 0x0000	NAME	DESCRIPTION	READ/WRITE
26.15:0	0000h	Reserved	Read returns 0s.	Read-only

Table 22. Status Register 1 (0x1B) Bit Definitions

BIT(S)	DEFAULT VALUE = 0x0000	NAME	DESCRIPTION	READ/WRITE
27.15:0	0000h	Reserved	Read returns 0s.	Read-only

Table 23. Status Register 2 (0x1C) Bit Definitions

BIT(S)	DEFAULT VALUE = 0x0000	NAME	DESCRIPTION	READ/WRITE
28.15:0	0000h	Reserved	Read returns 0s.	Read-only

TLK2208B 8-PORT GIGABIT ETHERNET TRANSCEIVER

SLLS578E – AUGUST 2003 – REVISED MARCH 2009

Table 24. Status Register 3 (0x1D) Bit Definitions

BIT(S)	DEFAULT VALUE = 0x0000	NAME	DESCRIPTION	READ/WRITE
29.15:8	00h	RX_SwRst[7:0]	Individual receive channel reset Resets channel when set to logic high	Read/write, self-clearing, See Note 5
29.7:0	00h	TX_SwRst[7:0]	Individual transmit channel reset Resets channel when set to logic high	Read/write, self-clearing, See Note 5

NOTE 5: After these bits are set to 1, they automatically set themselves back to 0 on the next MDC clock cycle. **Note:** In the transmit direction, channel pairs (A/B, C/D, E/F, G/H) have a common transmit clock and DDR input register bank. As a result, software assertion of the Channel A TX_SwRST MDIO register will temporarily corrupt Channel B data (until the software reset ends). Channel C TX_SwRST causes the same data corruption on Channel D. Channel E TX_SwRST causes the same data corruption on Channel F. Channel G TX_SwRST causes the same data corruption on Channel H.

Table 25. Test Register 1 (0x1E) Bit Definitions

BIT(S)	DEFAULT VALUE = 0x000B	NAME	DESCRIPTION	READ/WRITE
30.15:8	00h	TI_TST[7:0]	Reserved for TI testing	Read/write
30.7	0b	Reserved	Reserved for TI testing	Read-only
30.6	0b	ASYPHRCTL	Reserved for TI testing	Read/write
30.5	0b	BCLK_RST	Reserved for TI testing	Read/write
30.4	0b	TCLK_EN	Reserved for TI testing	Read/write
30.3	1b	LOCK2RX	Reserved for TI testing	Read/write
30.2	0b	PHRPOL	Reserved for TI testing	Read/write
30.1:0	11b	PHRMAG[1:0]	Reserved for TI testing	Read/write

Table 26. Test Register 1 (0x1F) Bit Definitions

BIT(S)	DEFAULT VALUE = 0x0000	NAME	DESCRIPTION	READ/WRITE
31.15:8	00h	RX PRBS_Pass[H:A]	PRBS pass information for all RX channels H through A	Read-only
31.7:0	00h	TX PRBS_Pass[H:A]	PRBS pass information for all TX channels H through A (reserved for TI testing)	Read-only

JTAG interface

The TLK2208B provides the full five-terminal JTAG interface as defined in IEEE 1149.1 to support manufacturing test.

serial loopback

The TLK2208B can provide a self-test function by enabling the internal serial loopback path for all channels with the assertion of LPBK. The loopback for individual channels can be enabled via the MDIO registers (22.15:8). The parallel data output can be compared to the parallel input data for that channel to perform functional verification. The external differential output is held in a high-impedance state during the serial loopback testing. Incoming data on the serial interface is disregarded.

Whenever a channel is switched into or out of LoopBack, that channel should be reset. The circuitry that switches the internal clock to the receive path does not preclude the possibility of glitches or short clock cycles when the TLK2208B is switched into or out of LoopBack. It is expected that whenever a channel of the TLK2208B is switched into LoopBack that that channel will be reset after making the switch. Also, it is expected that whenever a channel of the TLK2208B is switched out of LoopBack that that channel will be reset after making the switch.

This recommendation applies whether the LoopBack mode is enabled by way of the LPBK pin (ball D7) or by way of the MDIO register bits for global loopback in register 0, or whether individual channels are put in loopback by way of the individual MDIO register bits in register 22 (register 0x16).

far-end loopback

The TLK2208B can provide a self-test function by enabling the internal far-end loopback path for all or pairs of channels with the assertion of MDIO register bits 22.7:0. The serial data output can be compared to the serial input data for selected channels to perform functional verification of high-speed RX and TX. The parallel input data during the far-end loopback test is disregarded. The external parallel outputs are held in a high-impedance state during the far-end loopback testing.

power-on reset

Upon application of minimum valid power, the TLK2208B generates an internal power-on reset. During the power-on reset the receive data outputs are placed in the high-impedance state and the recovered receive clock terminals are held low. The length of the power-on reset cycle is dependent upon the ramp curve of the power supply. A typical value would be 1 ms after VDD crosses V_{th} (approx. 1/2 VDD). The power-on reset is sourced by the digital core supply voltage VDD.

PRBS generator and comparator

The TLK2208B has a built-in 2^7-1 pseudo-random bit stream (PRBS) self-test function available on each channel. Compared to all 8b/10b data pattern combinations, the PRBS is a worst-case bit pattern. The self-test function is enabled using the PRBSEN terminal or setting the PRBS enable bit in the MDIO registers. When the self-test function is enabled, a PRBS is generated and fed into the 10-bit parallel-to-serial converter input register. Data on the transmit data bus is ignored during the PRBS test mode. The PRBS pattern is then fed through the transmit circuitry as if it were normal data and sent out to the transmitter. The output can be sent to a bit-error rate tester (BERT), the receiver of another TLK2208B channel.

The result from PRBS verification at the RX ports of the device can be read from the MDIO registers 31.15:8. During PRBS testing (PRBS terminal asserted logic 1), RDxx[9:0] is disregarded.

TLK2208B

8-PORT GIGABIT ETHERNET TRANSCEIVER

SLLS578E – AUGUST 2003 – REVISED MARCH 2009

absolute maximum ratings over operating free-air temperature range (unless otherwise noted)†

I/O supply voltage, VDDQ (see Note 6)	–0.3 V to 3.0 V
Core supply voltage, VDD, VDDA (see Note 6)	–0.3 V to 2.5 V
Input voltage, V _I , (LVCMOS)	–0.5 V to 3.6V
DC input voltage (I/O)	–0.3 V to 2.5 V
Storage temperature	–65°C to 150°C
Electrostatic discharge	HBM: 2.5 kV, CDM: 750 V
Characterized free-air operating temperature range	0°C to 70°C

† Stresses beyond those listed under “absolute maximum ratings” may cause permanent damage to the device. These are stress ratings only, and functional operation of the device at these or any other conditions beyond those indicated under “recommended operating conditions” is not implied. Exposure to absolute-maximum-rated conditions for extended periods may affect device reliability.

NOTE 6: All voltage values, except differential I/O bus voltages, are with respect to network ground terminal.

recommended operating conditions

		MIN	NOM	MAX	UNIT
Core supply voltage, VDD	Peak-peak ac noise in the 1-MHz–10-MHz range may not exceed 100 mV.	1.7	1.8	1.9	V
I/O supply voltage, VDDQ	1.8-V LVCMOS Peak-peak ac noise may not exceed 150 mV.	1.7	1.8	1.9	V
	2.5V LVCMOS Peak-peak ac noise may not exceed 150 mV.	2.3	2.5	2.7	V
Analog supply voltage, VDDA	Peak-peak ac noise in the 1- MHz–10-MHz range may not exceed 100 mV.	1.7	1.8	1.9	V
Core supply current, I _{DD}	R _ω = 125 MHz, VDD = 1.8 V		340		mA
I/O supply current, I _{DDQ}	R _ω = 125 MHz, VDDQ = 1.8 V		90		mA
	R _ω = 125 MHz, VDDQ = 2.5 V		140		
Analog supply current, I _{DDA}	R _ω = 125 MHz, VDDA = 1.8 V		235		mA
Total power consumption, P _D	R _ω = 125 MHz, VDDQ = 1.8 V		1.3		W
Analog shutdown current, I _{sda}	ENABLE = Low		20		μA
Core shutdown current, I _{sdd}	ENABLE = Low		1		mA

See signal descriptions for list of LVCMOS signals.

LVCMOS electrical characteristics over recommended operating conditions (unless otherwise noted)

PARAMETER	TEST CONDITION	MIN	NOM	MAX	UNIT
V _{OH} High-level output voltage	I _{OH} = –400 μA, VDDQ = MIN	VDDQ–0.2		VDDQ	V
V _{OL} Low-level output voltage	I _{OL} = 1 mA, VDDQ = MIN	0	0.25	0.4	V
V _{IH} High-level input voltage	VDDQ = 1.8 V	1.17		VDDQ+0.2	V
	VDDQ = 2.5 V	1.7		VDDQ+0.2	
V _{IL} Low-level input voltage	VDDQ = 1.8 V	–0.2		0.63	V
	VDDQ = 2.5 V	–0.2		0.7	
I _{IH} High-level input current	VDDQ = MAX, V _{IN} = 2.0 V			40	μA
I _{IL} Low-level input current	VDDQ = MAX, V _{IN} = 0.4 V			–600	μA
C _{IN} Input capacitance				4	pF

NOTE: Unused inputs that do not hold an integrated pullup or pulldown circuit need to be terminated either to VDDQ or GND, respectively, to avoid excessive currents and lifetime degradation.

reference clock timing requirements (REFCLK) over recommended operating conditions (unless otherwise noted)

PARAMETER		TEST CONDITION	MIN	NOM	MAX	UNIT
R _ω	Frequency	Minimum data rate	NOM-0.01%	100	NOM+0.01%	MHz
		Maximum data rate	NOM-0.01%	130	NOM+0.01%	
Accuracy			-100		100	ppm
Duty cycle			40%	50%	60%	
Jitter, random and deterministic					40	ps

This clock should be crystal referenced to meet the requirements of the above table. Contact TI for specific clocking recommendations. Turning off REFCLK might lead to increased current consumption. If REFCLK is turned off, it is recommended to power down the IC via MDIO to avoid unwanted current drain.

serial transmitter/receiver characteristics

PARAMETER		TEST CONDITION	MIN	NOM	MAX	UNIT
V _{OD(p)}	TX output voltage magnitude	Maximum preemphasis enabled. See Figure 10	900	1050	1250	mV
V _{OD(d)}		Preemphasis disabled. See Figure 10	650	800	1050	mV
V _{OD(pp)}	TX output differential peak-to-peak voltage swing	Maximum preemphasis enabled. See Figure 10	1800	2100	2500	mVp-p
V _{OD(pd)}		Preemphasis disabled. See Figure 10	1300	1600	2100	mVp-p
V _(CMT)	TX output common-mode voltage range	See Figure 10	800		1200	mV
V _{ID}	RX input voltage magnitude away from common mode	See Figure 12	200		900	mV
V _{ID(p)}	RX input differential peak-to-peak voltage swing	See Figure 12	400		2500	mVp-p
I _{LKG}	RX input leakage current		-10		10	μA
C _I	RX input capacitance				2	pF
t _r , t _f	Differential output signal rise, fall time (20% to 80%)	R _L = 50 Ω, C _L = 5 pF, See Figure 10		150	220	ps
t _(J_TOL)	Jitter tolerance, total jitter at serial input	Zero crossing, See Figure 13			0.75	UI (Note 8)
t _(J_DR)	Serial input deterministic jitter	Zero crossing, See Figure 13			0.462	UI
t _(J_T)	Serial output total jitter	Alternating disparity K28.5, 1.25 Gbps		0.15	0.24	UI
t _(J_D)	Serial output deterministic jitter	Alternating disparity K28.5, 1.25 Gbps			0.12	UI
t _{d(R)}	Total delay from RD1 input to RD output			170		UI
t _{d(T)}	Total delay from TD input to TDO output			130		UI

NOTES: 7. REFCLK jitter equals to 6 ps RMS at RX and TX jitter measurements.
 8. Unit Interval = One serial bit time (minimum 800 ps)

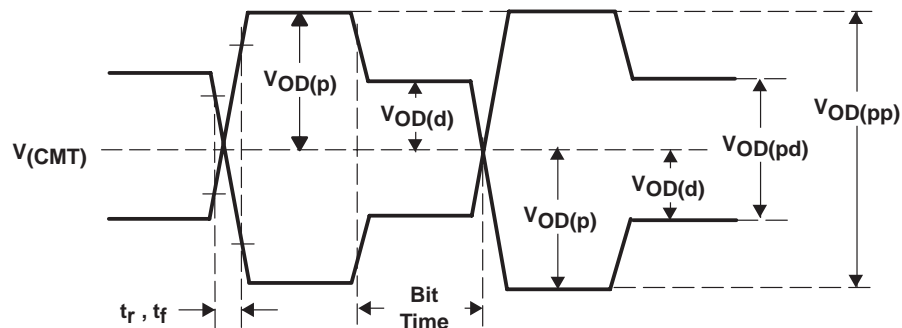

Figure 10. Differential and Common-Mode Output Voltage Definitions

TLK2208B
8-PORT GIGABIT ETHERNET TRANSCEIVER

SLLS578E – AUGUST 2003 – REVISED MARCH 2009

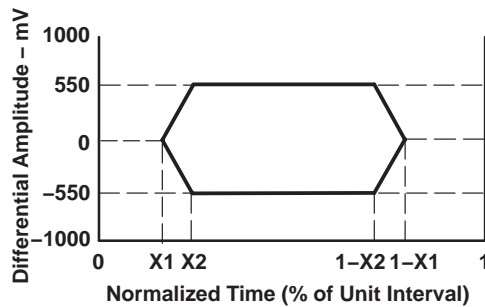

Figure 11. Absolute Eye Diagram Mask as TP2

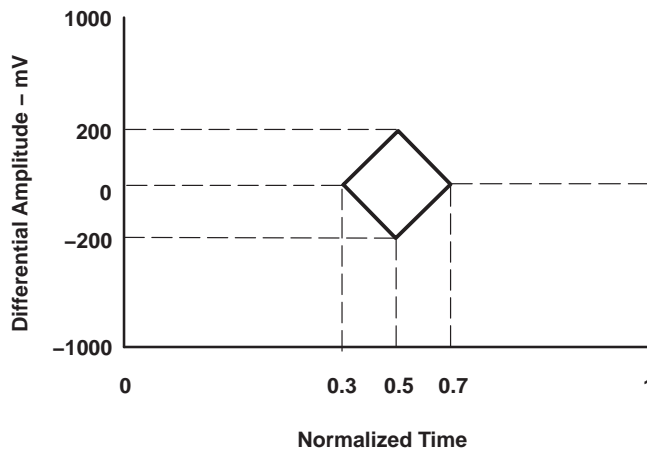
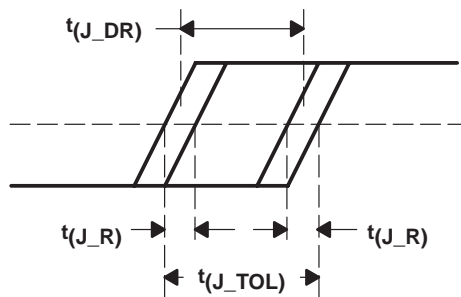

Figure 12. Eye Diagram Mask at Point-TP3



NOTE: $t(J_TOL) = t(J_R) + t(J_IDR)$, where $t(J_TOL)$ is the receive jitter tolerance, $t(J_DR)$ is the received deterministic jitter, and $t(J_R)$ is the Gaussian random edge jitter distribution at a maximum BER = 10^{-12} .

Figure 13. Input Jitter

LVC MOS output switching characteristics over recommended operating conditions (unless otherwise noted)

PARAMETER		TEST CONDITION	MIN	NOM	MAX	UNIT
t_r	Clock and data rise time	80% to 20% output voltage, C = 10 pF, See Figure 14	0.3		1.5	ns
		80% to 20% output voltage, C = 10 pF, See Figure 14	0.3		1.5	
t_f	Clock and data fall time	20% to 80% output voltage, C = 10 pF, See Figure 14	0.36		1.8	ns
		20% to 80% output voltage, C = 10 pF, See Figure 14	0.36		1.8	
t_{su}	RD[9:0] setup prior to RCLK transition high or low	Timing relative to 0.5 VDDQ, See Figure 14	1.4			ns
t_h	RD[9:0] hold after RCLK transition high or low	Timing relative to 0.5 VDDQ, See Figure 14	0.8			ns

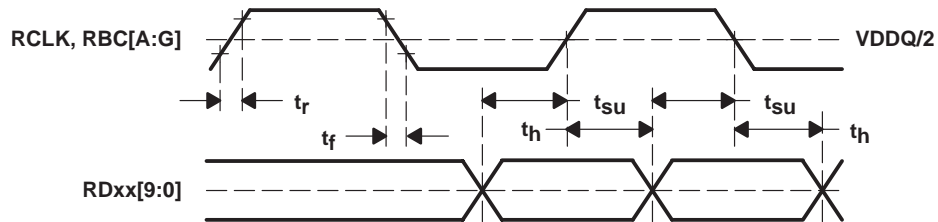

Figure 14. LVC MOS Receive Output Timing requirements

LVC MOS input timing requirements over recommended operating conditions (unless otherwise noted)

PARAMETER		TEST CONDITION	MIN	NOM†	MAX	UNIT
t_{su}	TDxx[9:0] setup prior to TCLKx transition high or low	Timing relative to 0.5 VDDQ See Figure 15	1.4			ns
t_h	TDxx[9:0] hold after TCLKx transition high or low	Timing relative to 0.5 VDD See Figure 15	0.0			ns
$t_{(Pulse)}‡$	TCLKx clock period divided by 2	Timing relative to 0.5 VDDQ, See Figure 16	3.85		5	ns

† All typical values are at 25°C and with a nominal supply.

‡ TCLKB is assumed to be frequency locked to REFCLK with only phase differences.

NOTE: Timings valid for V_{IH} no less than 80% of VDDQ and V_{IL} no higher than 20% VDDQ.

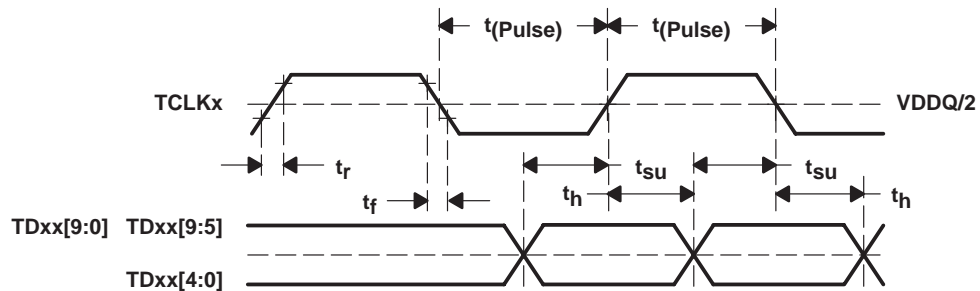

Figure 15. LVC MOS Source Centered Data Input Timing Requirements

TLK2208B 8-PORT GIGABIT ETHERNET TRANSCEIVER

SLLS578E – AUGUST 2003 – REVISED MARCH 2009

MDIO timing requirements over recommended operating conditions (unless otherwise noted)

PARAMETER	TEST CONDITION	MIN	NOM	MAX	UNIT
t_p	MDC period		500		ns
t_{su}	MDIO setup to \uparrow MDC	10			ns
t_h	MDIO hold to \uparrow MDC	10			ns

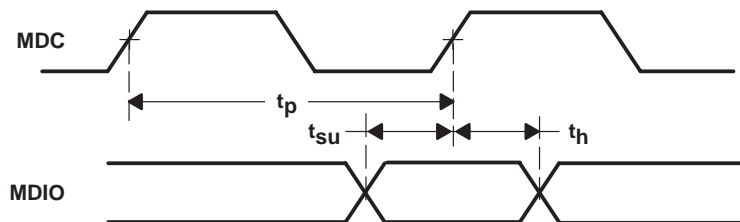

Figure 16. MDIO Read/Write Timing

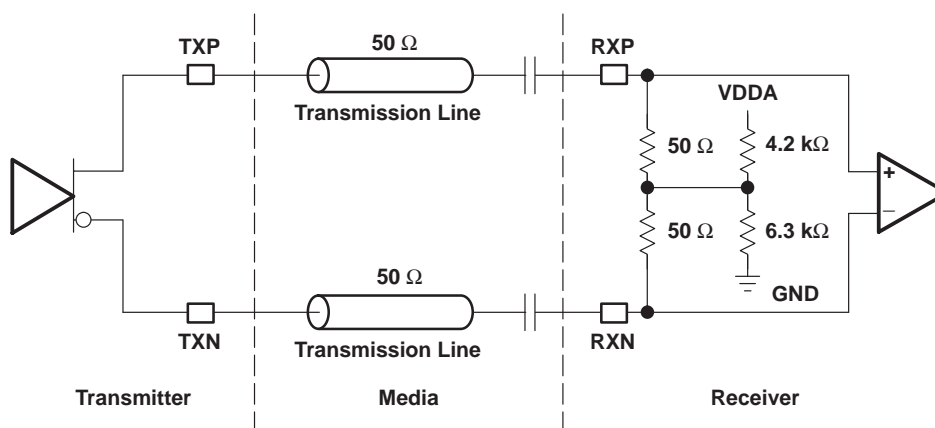

Figure 17. Example High-Speed I/O AC-Coupled Mode

AVAILABLE OPTIONS

T_A	PACKAGE	SYMBOL
	PLASTIC BALL GRID ARRAY 289 BGA (GPV)	
0°C to 70°C	TLK2208GPV	
	TLK2208ZPV	ECAT

NOTE: For the most current package and ordering information, see the Package Option Addendum at the end of this document, or see the TI website at www.ti.com.

PACKAGING INFORMATION

Orderable Device	Status (1)	Package Type	Package Drawing	Pins	Package Qty	Eco Plan (2)	Lead/Ball Finish (6)	MSL Peak Temp (3)	Op Temp (°C)	Device Marking (4/5)	Samples
TLK2208BGPV	LIFEBUY	BGA	GPV	289	84	TBD	SNPB	Level-3-220C-168 HR	0 to 70	TLK2208B	

(1) The marketing status values are defined as follows:

ACTIVE: Product device recommended for new designs.

LIFEBUY: TI has announced that the device will be discontinued, and a lifetime-buy period is in effect.

NRND: Not recommended for new designs. Device is in production to support existing customers, but TI does not recommend using this part in a new design.

PREVIEW: Device has been announced but is not in production. Samples may or may not be available.

OBSOLETE: TI has discontinued the production of the device.

(2) Eco Plan - The planned eco-friendly classification: Pb-Free (RoHS), Pb-Free (RoHS Exempt), or Green (RoHS & no Sb/Br) - please check <http://www.ti.com/productcontent> for the latest availability information and additional product content details.

TBD: The Pb-Free/Green conversion plan has not been defined.

Pb-Free (RoHS): TI's terms "Lead-Free" or "Pb-Free" mean semiconductor products that are compatible with the current RoHS requirements for all 6 substances, including the requirement that lead not exceed 0.1% by weight in homogeneous materials. Where designed to be soldered at high temperatures, TI Pb-Free products are suitable for use in specified lead-free processes.

Pb-Free (RoHS Exempt): This component has a RoHS exemption for either 1) lead-based flip-chip solder bumps used between the die and package, or 2) lead-based die adhesive used between the die and leadframe. The component is otherwise considered Pb-Free (RoHS compatible) as defined above.

Green (RoHS & no Sb/Br): TI defines "Green" to mean Pb-Free (RoHS compatible), and free of Bromine (Br) and Antimony (Sb) based flame retardants (Br or Sb do not exceed 0.1% by weight in homogeneous material)

(3) MSL, Peak Temp. - The Moisture Sensitivity Level rating according to the JEDEC industry standard classifications, and peak solder temperature.

(4) There may be additional marking, which relates to the logo, the lot trace code information, or the environmental category on the device.

(5) Multiple Device Markings will be inside parentheses. Only one Device Marking contained in parentheses and separated by a "~" will appear on a device. If a line is indented then it is a continuation of the previous line and the two combined represent the entire Device Marking for that device.

(6) Lead/Ball Finish - Orderable Devices may have multiple material finish options. Finish options are separated by a vertical ruled line. Lead/Ball Finish values may wrap to two lines if the finish value exceeds the maximum column width.

Important Information and Disclaimer: The information provided on this page represents TI's knowledge and belief as of the date that it is provided. TI bases its knowledge and belief on information provided by third parties, and makes no representation or warranty as to the accuracy of such information. Efforts are underway to better integrate information from third parties. TI has taken and continues to take reasonable steps to provide representative and accurate information but may not have conducted destructive testing or chemical analysis on incoming materials and chemicals. TI and TI suppliers consider certain information to be proprietary, and thus CAS numbers and other limited information may not be available for release.

In no event shall TI's liability arising out of such information exceed the total purchase price of the TI part(s) at issue in this document sold by TI to Customer on an annual basis.

GPV (S-PBGA-N289)

PLASTIC BALL GRID ARRAY

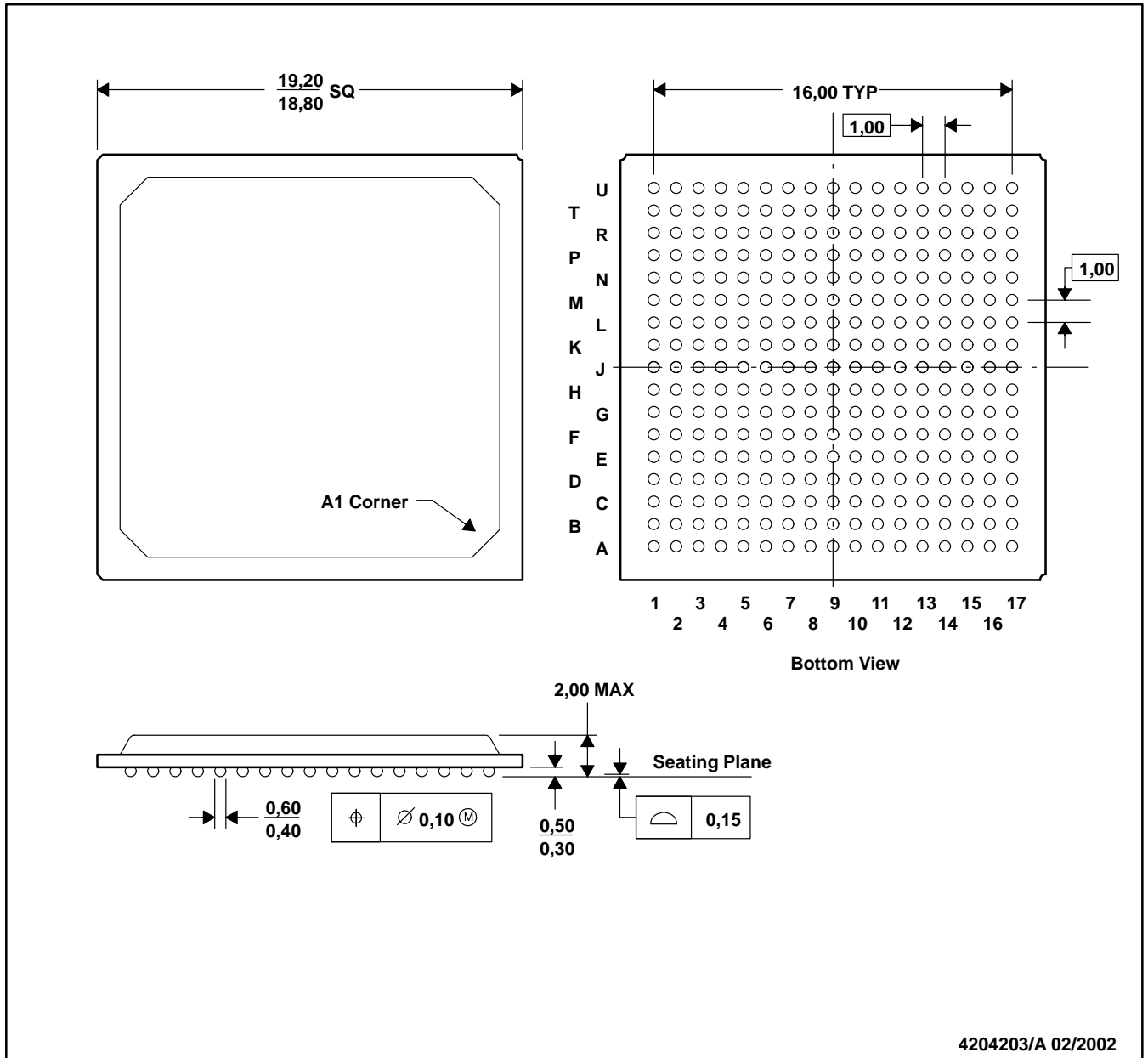

4204203/A 02/2002

- NOTES: A. All linear dimensions are in inches (millimeters).
 B. This drawing is subject to change without notice.

IMPORTANT NOTICE

Texas Instruments Incorporated and its subsidiaries (TI) reserve the right to make corrections, enhancements, improvements and other changes to its semiconductor products and services per JESD46, latest issue, and to discontinue any product or service per JESD48, latest issue. Buyers should obtain the latest relevant information before placing orders and should verify that such information is current and complete. All semiconductor products (also referred to herein as "components") are sold subject to TI's terms and conditions of sale supplied at the time of order acknowledgment.

TI warrants performance of its components to the specifications applicable at the time of sale, in accordance with the warranty in TI's terms and conditions of sale of semiconductor products. Testing and other quality control techniques are used to the extent TI deems necessary to support this warranty. Except where mandated by applicable law, testing of all parameters of each component is not necessarily performed.

TI assumes no liability for applications assistance or the design of Buyers' products. Buyers are responsible for their products and applications using TI components. To minimize the risks associated with Buyers' products and applications, Buyers should provide adequate design and operating safeguards.

TI does not warrant or represent that any license, either express or implied, is granted under any patent right, copyright, mask work right, or other intellectual property right relating to any combination, machine, or process in which TI components or services are used. Information published by TI regarding third-party products or services does not constitute a license to use such products or services or a warranty or endorsement thereof. Use of such information may require a license from a third party under the patents or other intellectual property of the third party, or a license from TI under the patents or other intellectual property of TI.

Reproduction of significant portions of TI information in TI data books or data sheets is permissible only if reproduction is without alteration and is accompanied by all associated warranties, conditions, limitations, and notices. TI is not responsible or liable for such altered documentation. Information of third parties may be subject to additional restrictions.

Resale of TI components or services with statements different from or beyond the parameters stated by TI for that component or service voids all express and any implied warranties for the associated TI component or service and is an unfair and deceptive business practice. TI is not responsible or liable for any such statements.

Buyer acknowledges and agrees that it is solely responsible for compliance with all legal, regulatory and safety-related requirements concerning its products, and any use of TI components in its applications, notwithstanding any applications-related information or support that may be provided by TI. Buyer represents and agrees that it has all the necessary expertise to create and implement safeguards which anticipate dangerous consequences of failures, monitor failures and their consequences, lessen the likelihood of failures that might cause harm and take appropriate remedial actions. Buyer will fully indemnify TI and its representatives against any damages arising out of the use of any TI components in safety-critical applications.

In some cases, TI components may be promoted specifically to facilitate safety-related applications. With such components, TI's goal is to help enable customers to design and create their own end-product solutions that meet applicable functional safety standards and requirements. Nonetheless, such components are subject to these terms.

No TI components are authorized for use in FDA Class III (or similar life-critical medical equipment) unless authorized officers of the parties have executed a special agreement specifically governing such use.

Only those TI components which TI has specifically designated as military grade or "enhanced plastic" are designed and intended for use in military/aerospace applications or environments. Buyer acknowledges and agrees that any military or aerospace use of TI components which have **not** been so designated is solely at the Buyer's risk, and that Buyer is solely responsible for compliance with all legal and regulatory requirements in connection with such use.

TI has specifically designated certain components as meeting ISO/TS16949 requirements, mainly for automotive use. In any case of use of non-designated products, TI will not be responsible for any failure to meet ISO/TS16949.

Products

Audio	www.ti.com/audio
Amplifiers	amplifier.ti.com
Data Converters	dataconverter.ti.com
DLP® Products	www.dlp.com
DSP	dsp.ti.com
Clocks and Timers	www.ti.com/clocks
Interface	interface.ti.com
Logic	logic.ti.com
Power Mgmt	power.ti.com
Microcontrollers	microcontroller.ti.com
RFID	www.ti-rfid.com
OMAP Applications Processors	www.ti.com/omap
Wireless Connectivity	www.ti.com/wirelessconnectivity

Applications

Automotive and Transportation	www.ti.com/automotive
Communications and Telecom	www.ti.com/communications
Computers and Peripherals	www.ti.com/computers
Consumer Electronics	www.ti.com/consumer-apps
Energy and Lighting	www.ti.com/energy
Industrial	www.ti.com/industrial
Medical	www.ti.com/medical
Security	www.ti.com/security
Space, Avionics and Defense	www.ti.com/space-avionics-defense
Video and Imaging	www.ti.com/video

TI E2E Community

e2e.ti.com