

**TLV225x, TLV225xA**  
**Advanced LinCMOS™ RAIL-TO-RAIL**  
**VERY LOW-POWER OPERATIONAL AMPLIFIERS**

SLOS185D – FEBRUARY 1997 – REVISED AUGUST 2006

- Output Swing Includes Both Supply Rails
- Low Noise . . . 19 nV/√Hz Typ at f = 1 kHz
- Low Input Bias Current . . . 1 pA Typ
- Fully Specified for Both Single-Supply and Split-Supply Operation
- Very Low Power . . . 34 μA Per Channel Typ
- Common-Mode Input Voltage Range Includes Negative Rail
- Low Input Offset Voltage  
850 μV Max at T<sub>A</sub> = 25°C
- Wide Supply Voltage Range  
2.7 V to 8 V
- Macromodel Included
- Available in Q-Temp Automotive  
HighRel Automotive Applications  
Configuration Control / Print Support  
Qualification to Automotive Standards

**description**

The TLV2252 and TLV2254 are dual and quadruple low-voltage operational amplifiers from Texas Instruments. Both devices exhibit rail-to-rail output performance for increased dynamic range in single- or split-supply applications. The TLV225x family consumes only 34 μA of supply current per channel. This micropower operation makes them good choices for battery-powered applications. This family is fully characterized at 3 V and 5 V and is optimized for low-voltage applications. The noise performance has been dramatically improved over previous generations of CMOS amplifiers. The TLV225x has a noise level of 19 nV/√Hz at 1kHz, four times lower than competitive micropower solutions.

The TLV225x, exhibiting high input impedance and low noise, are excellent for small-signal conditioning for high-impedance sources, such as piezoelectric transducers. Because of the micropower dissipation levels combined with 3-V operation, these devices work well in hand-held monitoring and remote-sensing applications. In addition, the rail-to-rail output feature with single or split supplies makes this family a great choice when interfacing with analog-to-digital converters (ADCs). For precision applications, the TLV225xA family is available and has a maximum input offset voltage of 850 μV.

The TLV2252/4 also make great upgrades to the TLV2322/4 in standard designs. They offer increased output dynamic range, lower noise voltage, and lower input offset voltage. This enhanced feature set allows them to be used in a wider range of applications. For applications that require higher output drive and wider input voltage range, see the TLV2432 and TLV2442 devices. If your design requires single amplifiers, please see the TLV2211/21/31 family. These devices are single rail-to-rail operational amplifiers in the SOT-23 package. Their small size and low power consumption, make them ideal for high density, battery-powered equipment.

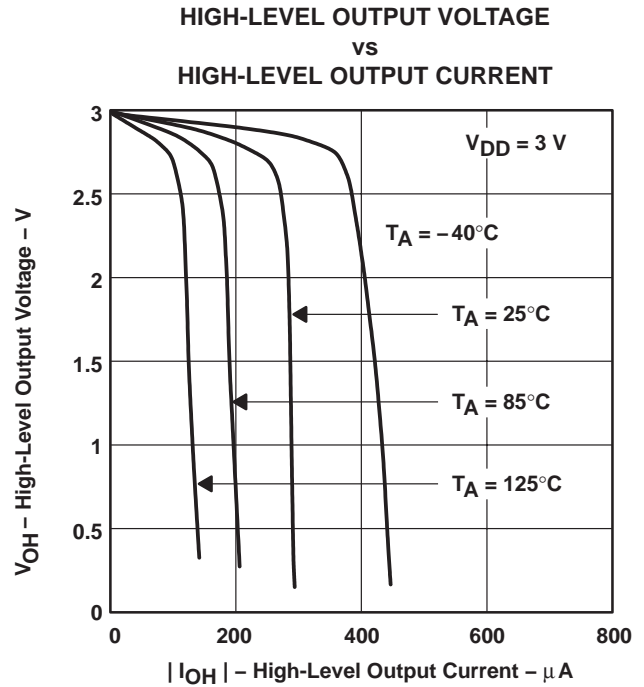

Please be aware that an important notice concerning availability, standard warranty, and use in critical applications of Texas Instruments semiconductor products and disclaimers thereto appears at the end of this data sheet.

Advanced LinCMOS is a trademark of Texas Instruments.

PRODUCTION DATA information is current as of publication date. Products conform to specifications per the terms of Texas Instruments standard warranty. Production processing does not necessarily include testing of all parameters.



POST OFFICE BOX 655303 • DALLAS, TEXAS 75265

Copyright © 1997–2006, Texas Instruments Incorporated  
 On products compliant to MIL-PRF-38535, all parameters are tested unless otherwise noted. On all other products, production processing does not necessarily include testing of all parameters.

**TLV225x, TLV225xA**  
**Advanced LinCMOS™ RAIL-TO-RAIL**  
**VERY LOW-POWER OPERATIONAL AMPLIFIERS**

SLOS185D – FEBRUARY 1997 – REVISED AUGUST 2006

**TLV2252 AVAILABLE OPTIONS**

T <sub>A</sub>	V <sub>IOmax</sub> AT 25°C	PACKAGED DEVICES					
		SMALL OUTLINE† (D)	CHIP CARRIER (FK)	CERAMIC DIP (JG)	PLASTIC DIP (P)	TSSOP‡ (PW)	CERAMIC FLATPACK (U)
-40°C to 125°C	850 µV 1500 µV	TLV2252AID TLV2252ID	— —	— —	TLV2252AIP TLV2252IP	TLV2252AIPWLE —	— —
-40°C to 125°C	850 µV 1500 µV	TLV2252AQD TLV2252QD	— —	— —	— —	— —	— —
-55°C to 125°C	850 µV 1500 µV	— —	TLV2252AMFK TLV2252MFK	TLV2252AMJG TLV2252MJG	— —	— —	TLV2252AMU TLV2252MU

† The D packages are available taped and reeled. Add R suffix to device type (e.g., TLV2252CDR).

‡ The PW package is available only left-end taped and reeled.

§ Chips are tested at 25°C.

**TLV2254 AVAILABLE OPTIONS**

T <sub>A</sub>	V <sub>IOmax</sub> AT 25°C	PACKAGED DEVICES					
		SMALL OUTLINE† (D)	CHIP CARRIER (FK)	CERAMIC DIP (J)	PLASTIC DIP (N)	TSSOP‡ (PW)	CERAMIC FLATPACK (W)
-40°C to 125°C	850 µV 1500 µV	TLV2254AID TLV2254ID	— —	— —	TLV2254AIN TLV2254IN	TLV2254AIPWLE —	— —
-40°C to 125°C	850 µV 1500 µV	TLV2254AQD TLV2254QD	— —	— —	— —	— —	— —
-55°C to 125°C	850 µV 1500 µV	— —	TLV2254AMFK TLV2254MFK	TLV2254AMJ TLV2254MJ	— —	— —	TLV2254AMW TLV2254MW

† The D packages are available taped and reeled. Add R suffix to device type (e.g., TLV2254CDR).

‡ The PW package is available only left-end taped and reeled.

§ Chips are tested at 25°C.



**TLV225x, TLV225xA**  
**Advanced LinCMOS™ RAIL-TO-RAIL**  
**VERY LOW-POWER OPERATIONAL AMPLIFIERS**

SLOS185D – FEBRUARY 1997 – REVISED AUGUST 2006

**TLV2252I, TLV2252AI**  
**TLV2252Q, TLV2252AQ**  
**D, P, OR PW PACKAGE**  
**(TOP VIEW)**

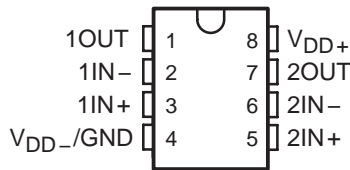

**TLV2252M, TLV2252AM . . . JG PACKAGE**  
**(TOP VIEW)**

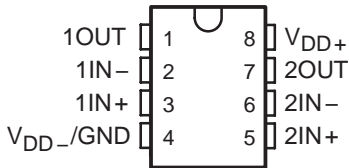

**TLV2252M, TLV2252AM . . . U PACKAGE**  
**(TOP VIEW)**

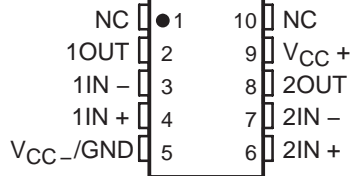

**TLV2252M, TLV2252AM . . . FK PACKAGE**  
**(TOP VIEW)**

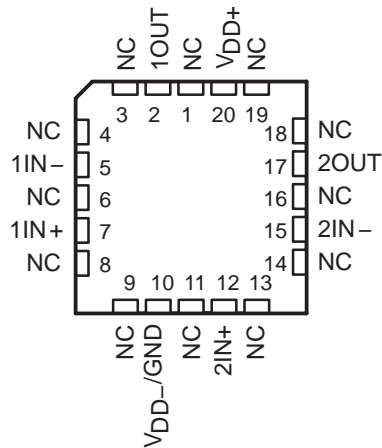

**TLV2254I, TLV2254AI, TLV2254Q, TLV2254AQ . . . D OR N PACKAGE**  
**TLV2254M, TLV2254AM . . . J OR W PACKAGE**  
**(TOP VIEW)**

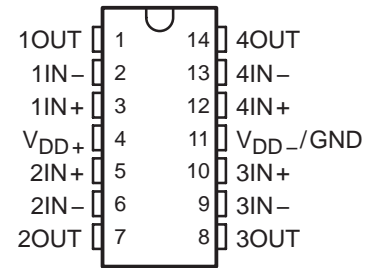

**TLV2254I, TLV2254AI . . . PW PACKAGE**  
**(TOP VIEW)**

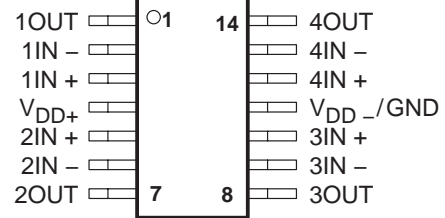

**TLV2254M, TLV2254AM . . . FK PACKAGE**  
**(TOP VIEW)**

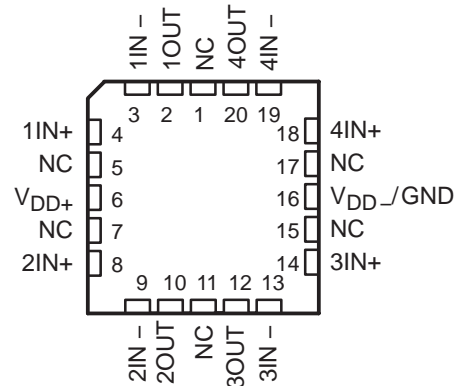

# TLV225x, TLV2252xA

## Advanced LinCMOS™ RAIL-TO-RAIL

### VERY LOW-POWER OPERATIONAL AMPLIFIERS

SLOS185D – FEBRUARY 1997 – REVISED AUGUST 2006

equivalent schematic (each amplifier)

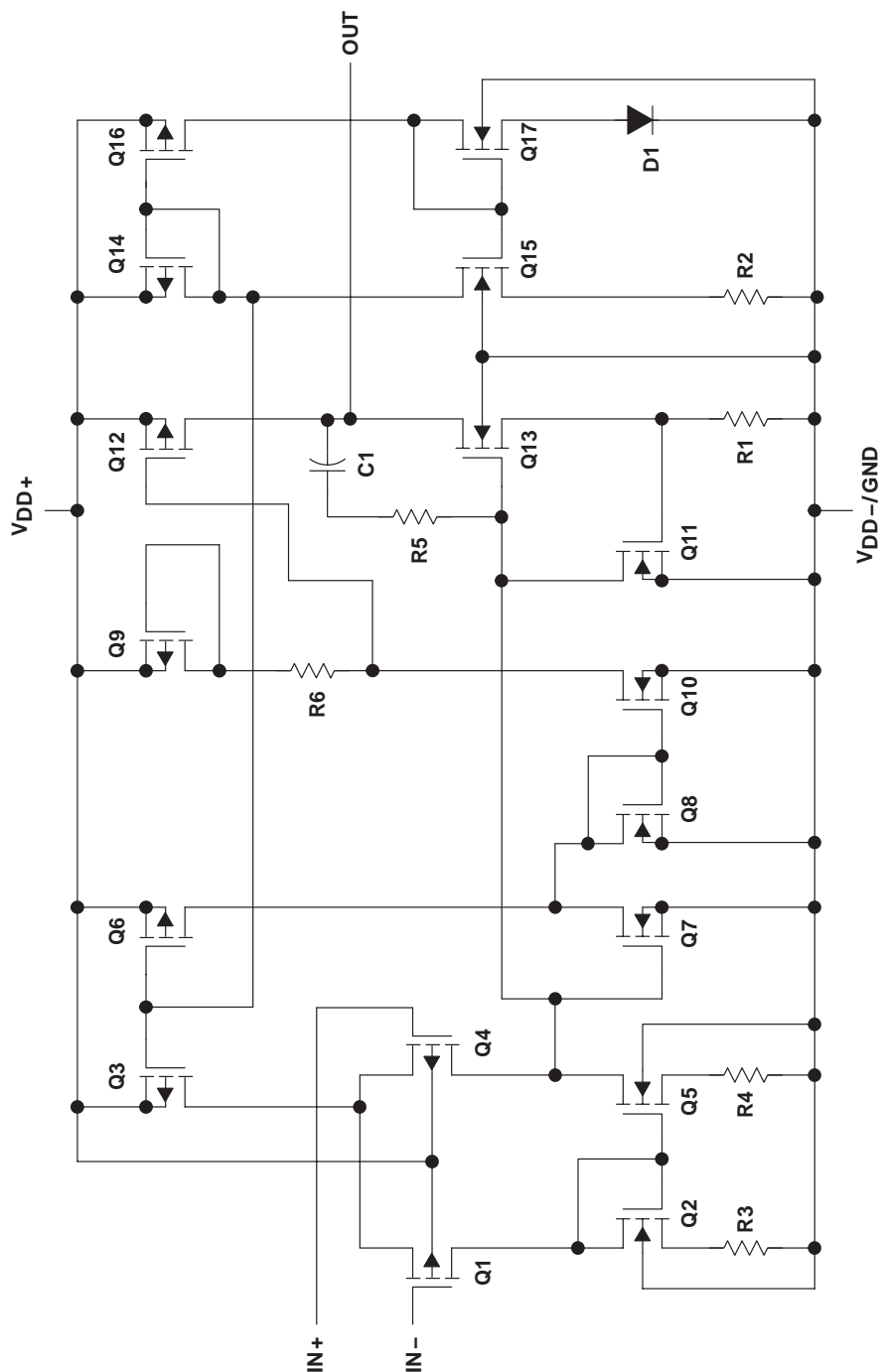

ACTUAL DEVICE COMPONENT COUNT†		
COMPONENT	TLV2252	TLV2254
Transistors	38	76
Resistors	30	56
Diodes	9	18
Capacitors	3	6

† Includes both amplifiers and all ESD, bias, and trim circuitry

**TLV225x, TLV225xA**  
**Advanced LinCMOS™ RAIL-TO-RAIL**  
**VERY LOW-POWER OPERATIONAL AMPLIFIERS**

SLOS185D – FEBRUARY 1997 – REVISED AUGUST 2006

**absolute maximum ratings over operating free-air temperature range (unless otherwise noted)†**

Supply voltage, $V_{DD}$ (see Note 1)	16 V
Differential input voltage, $V_{ID}$ (see Note 2)	$\pm V_{DD}$
Input voltage range, $V_I$ (any input, see Note 1)	$V_{DD-} - 0.3 \text{ V to } V_{DD+}$
Input current, $I_I$ (each input)	$\pm 5 \text{ mA}$
Output current, $I_O$	$\pm 50 \text{ mA}$
Total current into $V_{DD+}$	$\pm 50 \text{ mA}$
Total current out of $V_{DD-}$	$\pm 50 \text{ mA}$
Duration of short-circuit current (at or below) 25°C (see Note 3)	unlimited
Continuous total power dissipation	See Dissipation Rating Table
Operating free-air temperature range, $T_A$ : I Suffix	-40°C to 125°C
Q Suffix	-40°C to 125°C
M Suffix	-55°C to 125°C
Storage temperature range, $T_{stg}$	-65°C to 150°C
Lead temperature 1,6 mm (1/16 inch) from case for 10 seconds: D, N, P, and PW packages	260°C
J, JG, U, and W packages	300°C

† Stresses beyond those listed under “absolute maximum ratings” may cause permanent damage to the device. These are stress ratings only, and functional operation of the device at these or any other conditions beyond those indicated under “recommended operating conditions” is not implied. Exposure to absolute-maximum-rated conditions for extended periods may affect device reliability.

- NOTES: 1. All voltage values, except differential voltages, are with respect to  $V_{DD-}$ .  
2. Differential voltages are at the noninverting input with respect to the inverting input. Excessive current flows when input is brought below  $V_{DD-} - 0.3 \text{ V}$ .  
3. The output may be shorted to either supply. Temperature and/or supply voltages must be limited to ensure that the maximum dissipation rating is not exceeded.

**DISSIPATION RATING TABLE**

PACKAGE	$T_A \leq 25^\circ\text{C}$ POWER RATING	DERATING FACTOR ABOVE $T_A = 25^\circ\text{C}$	$T_A = 85^\circ\text{C}$ POWER RATING	$T_A = 125^\circ\text{C}$ POWER RATING
D-8	725 mW	5.8 mW/°C	377 mW	145 mW
D-14	950 mW	7.6 mW/°C	494 mW	190 mW
FK	1375 mW	11.0 mW/°C	715 mW	275 mW
J	1375 mW	11.0 mW/°C	715 mW	275 mW
JG	1050 mW	8.4 mW/°C	546 mW	210 mW
N	1150 mW	9.2 mW/°C	598 mW	230 mW
P	1000 mW	8.0 mW/°C	520 mW	200 mW
PW-8	525 mW	4.2 mW/°C	273 mW	105 mW
PW-14	700 mW	5.6 mW/°C	364 mW	140 mW
U	700 mW	5.5 mW/°C	370 mW	150 mW
W	700 mW	5.5 mW/°C	370 mW	150 mW

**recommended operating conditions**

	TLV225xI		TLV225xQ		TLV225xM		UNIT
	MIN	MAX	MIN	MAX	MIN	MAX	
Supply voltage, $V_{DD}$ (see Note 1)	2.7	8	2.7	8	2.7	8	V
Input voltage range, $V_I$	$V_{DD-}$	$V_{DD+} - 1.3$	$V_{DD-}$	$V_{DD+} - 1.3$	$V_{DD-}$	$V_{DD+} - 1.3$	V
Common-mode input voltage, $V_{IC}$	$V_{DD-}$	$V_{DD+} - 1.3$	$V_{DD-}$	$V_{DD+} - 1.3$	$V_{DD-}$	$V_{DD+} - 1.3$	V
Operating free-air temperature, $T_A$	-40	125	-40	125	-55	125	°C

NOTE 1: All voltage values, except differential voltages, are with respect to  $V_{DD-}$ .



**TLV225x, TLV225xA**  
**Advanced LinCMOS™ RAIL-TO-RAIL**  
**VERY LOW-POWER OPERATIONAL AMPLIFIERS**

SLOS185D – FEBRUARY 1997 – REVISED AUGUST 2006

**TLV2252I electrical characteristics at specified free-air temperature,  $V_{DD} = 3\text{ V}$  (unless otherwise noted)**

PARAMETER	TEST CONDITIONS	$T_A$ †	TLV2252I			TLV2252AI			UNIT
			MIN	TYP	MAX	MIN	TYP	MAX	
$V_{IO}$ Input offset voltage		25°C	200	1500		200	850	$\mu\text{V}$	
		Full range			1750		1000		
$\alpha_{VIO}$ Temperature coefficient of input offset voltage		25°C to 85°C	0.5			0.5		$\mu\text{V}/^\circ\text{C}$	
Input offset voltage long-term drift (see Note 4)		25°C	0.003			0.003		$\mu\text{V}/\text{mo}$	
$I_{IO}$ Input offset current	$V_{DD\pm} = \pm 1.5\text{ V}$ , $V_O = 0$ , $V_{IC} = 0$ , $R_S = 50\ \Omega$	25°C	0.5	60		0.5	60	pA	
		-40°C to 85°C			150		150		
		Full range			1000		1000		
$I_{IB}$ Input bias current		25°C	1	60		1	60	pA	
		-40°C to 85°C			150		150		
		Full range			1000		1000		
$V_{ICR}$ Common-mode input voltage range	$R_S = 50\ \Omega$ , $ V_{IO}  \leq 5\text{ mV}$	25°C	0 to 2	-0.3 to 2.2		0 to 2	-0.3 to 2.2	V	
		Full range	0 to 1.7			0 to 1.7			
$V_{OH}$ High-level output voltage	$I_{OH} = -20\ \mu\text{A}$	25°C	2.98			2.98			V
	$I_{OH} = -75\ \mu\text{A}$	25°C	2.9			2.9			
	$I_{OH} = -150\ \mu\text{A}$	Full range	2.8			2.8			
		25°C	2.8			2.8			
$V_{OL}$ Low-level output voltage	$V_{IC} = 1.5\text{ V}$ , $I_{OL} = 50\ \mu\text{A}$	25°C	10			10			mV
		Full range	80			80			
	$V_{IC} = 1.5\text{ V}$ , $I_{OL} = 500\ \mu\text{A}$	25°C	100			100			
		Full range	150			150			
	$V_{IC} = 1.5\text{ V}$ , $I_{OL} = 1\text{ mA}$	25°C	200			200			
		Full range	300			300			
$A_{VD}$ Large-signal differential voltage amplification	$V_{IC} = 1.5\text{ V}$ , $V_O = 1\text{ V to } 2\text{ V}$	$R_L = 100\text{ k}\Omega$ ‡	25°C	100	250		100	250	V/mV
			Full range	10			10		
		$R_L = 1\text{ M}\Omega$ ‡	25°C	800			800		
$r_{i(d)}$ Differential input resistance		25°C	$10^{12}$			$10^{12}$			$\Omega$
$r_{i(c)}$ Common-mode input resistance		25°C	$10^{12}$			$10^{12}$			$\Omega$
$C_{i(c)}$ Common-mode input capacitance	$f = 10\text{ kHz}$ , P package	25°C	8			8			pF
$z_o$ Closed-loop output impedance	$f = 25\text{ kHz}$ , $A_V = 10$	25°C	220			220			$\Omega$
CMRR Common-mode rejection ratio	$V_{IC} = 0\text{ to } 1.7\text{ V}$ , $V_O = 1.5\text{ V}$ , $R_S = 50\ \Omega$	25°C	65	75		65	77	dB	
		Full range	60			60			

† Full range is -40°C to 125°C.

‡ Referenced to 1.5 V

NOTE 4: Typical values are based on the input offset voltage shift observed through 500 hours of operating life test at  $T_A = 150^\circ\text{C}$  extrapolated to  $T_A = 25^\circ\text{C}$  using the Arrhenius equation and assuming an activation energy of 0.96 eV.



**TLV225x, TLV225xA**  
**Advanced LinCMOS™ RAIL-TO-RAIL**  
**VERY LOW-POWER OPERATIONAL AMPLIFIERS**

SLOS185D – FEBRUARY 1997 – REVISED AUGUST 2006

**TLV2252I electrical characteristics at specified free-air temperature,  $V_{DD} = 3\text{ V}$  (unless otherwise noted) (continued)**

PARAMETER	TEST CONDITIONS	$T_A$ †	TLV2252I			TLV2252AI			UNIT	
			MIN	TYP	MAX	MIN	TYP	MAX		
$k_{SVR}$	Supply voltage rejection ratio ( $\Delta V_{DD} / \Delta V_{IO}$ )	$V_{DD} = 2.7\text{ V to } 8\text{ V}$ , $V_{IC} = V_{DD}/2$ , No load	25°C	80	95		80	100	dB	
			Full range	80			80			
$I_{DD}$	Supply current	$V_O = 1.5\text{ V}$ , No load	25°C		68	125		68	125	$\mu\text{A}$
			Full range			150		150		

† Full range is  $-40^\circ\text{C}$  to  $125^\circ\text{C}$ .

**TLV2252I operating characteristics at specified free-air temperature,  $V_{DD} = 3\text{ V}$**

PARAMETER	TEST CONDITIONS	$T_A$ †	TLV2252I			TLV2252AI			UNIT
			MIN	TYP	MAX	MIN	TYP	MAX	
SR	Slew rate at unity gain	$V_O = 1.1\text{ V to } 1.9\text{ V}$ , $R_L = 100\text{ k}\Omega^\ddagger$ , $C_L = 100\text{ pF}^\ddagger$	25°C	0.07	0.1		0.07	0.1	$\text{V}/\mu\text{s}$
			Full range	0.05			0.05		
$V_n$	Equivalent input noise voltage	$f = 10\text{ Hz}$ $f = 1\text{ kHz}$	25°C		35		35	$\text{nV}/\sqrt{\text{Hz}}$	
			25°C		19		19		
$V_{N(PP)}$	Peak-to-peak equivalent input noise voltage	$f = 0.1\text{ Hz to } 1\text{ Hz}$ $f = 0.1\text{ Hz to } 10\text{ Hz}$	25°C		0.6		0.6	$\mu\text{V}$	
			25°C		1.1		1.1		
$I_n$	Equivalent input noise current		25°C		0.6		0.6	$\text{fA}/\sqrt{\text{Hz}}$	
	Gain-bandwidth product	$f = 1\text{ kHz}$ , $C_L = 100\text{ pF}^\ddagger$	$R_L = 50\text{ k}\Omega^\ddagger$ , 25°C		0.187		0.187	MHz	
BOM	Maximum output-swing bandwidth	$V_{O(PP)} = 1\text{ V}$ , $R_L = 50\text{ k}\Omega^\ddagger$	$A_V = 1$ , $C_L = 100\text{ pF}^\ddagger$ , 25°C		60		60	kHz	
$\phi_m$	Phase margin at unity gain	$R_L = 50\text{ k}\Omega^\ddagger$ , $C_L = 100\text{ pF}^\ddagger$	25°C		63°		63°		
	Gain margin		25°C		15		15	dB	

† Full range is  $-40^\circ\text{C}$  to  $125^\circ\text{C}$ .

‡ Referenced to 1.5 V

**TLV225x, TLV225xA**  
**Advanced LinCMOS™ RAIL-TO-RAIL**  
**VERY LOW-POWER OPERATIONAL AMPLIFIERS**

SLOS185D – FEBRUARY 1997 – REVISED AUGUST 2006

**TLV2252I electrical characteristics at specified free-air temperature,  $V_{DD} = 5\text{ V}$  (unless otherwise noted)**

PARAMETER	TEST CONDITIONS	$T_A$ †	TLV2252I			TLV2252AI			UNIT
			MIN	TYP	MAX	MIN	TYP	MAX	
$V_{IO}$ Input offset voltage		25°C	200	1500		200	850	$\mu\text{V}$	
		Full range			1750		1000		
$\alpha_{VIO}$ Temperature coefficient of input offset voltage		25°C to 85°C	0.5			0.5			$\mu\text{V}/^\circ\text{C}$
Input offset voltage long-term drift (see Note 4)		25°C	0.003			0.003			$\mu\text{V}/\text{mo}$
$I_{IO}$ Input offset current	$V_{DD\pm} = \pm 2.5\text{ V}$ , $V_O = 0$ , $V_{IC} = 0$ , $R_S = 50\ \Omega$	25°C	0.5		60	0.5		60	pA
		-40°C to 85°C	150			150			
		Full range	1000			1000			
$I_{IB}$ Input bias current		25°C	1		60	1		60	pA
		-40°C to 85°C	150			150			
		Full range	1000			1000			
$V_{ICR}$ Common-mode input voltage range	$ V_{IO}  \leq 5\text{ mV}$ , $R_S = 50\ \Omega$	25°C	0 to 4	-0.3 to 4.2		0 to 4	-0.3 to 4.2	V	
		Full range	0 to 3.5		0 to 3.5				
$V_{OH}$ High-level output voltage	$I_{OH} = -20\ \mu\text{A}$	25°C	4.98		4.98		V		
	$I_{OH} = -75\ \mu\text{A}$	25°C	4.9	4.94	4.9	4.94			
	Full range	4.8		4.8					
$V_{OL}$ Low-level output voltage	$V_{IC} = 2.5\text{ V}$ , $I_{OL} = 50\ \mu\text{A}$	25°C	0.01		0.01		V		
		Full range	0.06		0.06				
	$V_{IC} = 2.5\text{ V}$ , $I_{OL} = 500\ \mu\text{A}$	25°C	0.09	0.15	0.09	0.15			
		Full range	0.15		0.15				
	$V_{IC} = 2.5\text{ V}$ , $I_{OL} = 1\text{ mA}$	25°C	0.2	0.3	0.2	0.3			
		Full range	0.3		0.3				
$AVD$ Large-signal differential voltage amplification	$V_{IC} = 2.5\text{ V}$ , $V_O = 1\text{ V to }4\text{ V}$	$R_L = 100\text{ k}\Omega$ ‡	25°C	100	350	100	350	V/mV	
			Full range	10		10			
		$R_L = 1\text{ M}\Omega$ ‡	25°C	1700		1700			
$r_{i(d)}$ Differential input resistance		25°C	$10^{12}$		$10^{12}$		$\Omega$		
$r_{i(c)}$ Common-mode input resistance		25°C	$10^{12}$		$10^{12}$		$\Omega$		
$C_{i(c)}$ Common-mode input capacitance	$f = 10\text{ kHz}$ , P package	25°C	8		8		pF		
$z_o$ Closed-loop output impedance	$f = 25\text{ kHz}$ , $A_V = 10$	25°C	200		200		$\Omega$		
CMRR Common-mode rejection ratio	$V_{IC} = 0\text{ to }2.7\text{ V}$ , $V_O = 2.5\text{ V}$ , $R_S = 50\ \Omega$	25°C	70	83	70	83	dB		
		Full range	70		70				

† Full range is -40°C to 125°C.

‡ Referenced to 2.5 V

NOTE 4: Typical values are based on the input offset voltage shift observed through 500 hours of operating life test at  $T_A = 150^\circ\text{C}$  extrapolated to  $T_A = 25^\circ\text{C}$  using the Arrhenius equation and assuming an activation energy of 0.96 eV.



**TLV2252I electrical characteristics at specified free-air temperature,  $V_{DD} = 5\text{ V}$  (unless otherwise noted) (continued)**

PARAMETER	TEST CONDITIONS	$T_A$ †	TLV2252I			TLV2252AI			UNIT	
			MIN	TYP	MAX	MIN	TYP	MAX		
$k_{SVR}$	Supply voltage rejection ratio ( $\Delta V_{DD}/\Delta V_{IO}$ )	$V_{DD} = 4.4\text{ V to }8\text{ V}$ , $V_{IC} = V_{DD}/2$ , No load	25°C	80	95		80	95	dB	
			Full range	80			80			
$I_{DD}$	Supply current	$V_O = 2.5\text{ V}$ , No load	25°C		70	125		70	125	$\mu\text{A}$
			Full range			150			150	

† Full range is – 40°C to 125°C.

**TLV2252I operating characteristics at specified free-air temperature,  $V_{DD} = 5\text{ V}$**

PARAMETER	TEST CONDITIONS	$T_A$ †	TLV2252I			TLV2252AI			UNIT
			MIN	TYP	MAX	MIN	TYP	MAX	
SR	Slew rate at unity gain	$V_O = 1.5\text{ V to }3.5\text{ V}$ , $R_L = 100\text{ k}\Omega$ ‡, $C_L = 100\text{ pF}$ ‡	25°C	0.07	0.12		0.07	0.12	$\text{V}/\mu\text{s}$
			Full range	0.05			0.05		
$V_n$	Equivalent input noise voltage	$f = 10\text{ Hz}$ $f = 1\text{ kHz}$	25°C		36			36	$\text{nV}/\sqrt{\text{Hz}}$
			25°C		19			19	
$V_{N(PP)}$	Peak-to-peak equivalent input noise voltage	$f = 0.1\text{ Hz to }1\text{ Hz}$ $f = 0.1\text{ Hz to }10\text{ Hz}$	25°C		0.7			0.7	$\mu\text{V}$
			25°C		1.1			1.1	
$I_n$	Equivalent input noise current		25°C		0.6			0.6	$\text{fA}/\sqrt{\text{Hz}}$
THD + N	Total harmonic distortion plus noise	$V_O = 0.5\text{ V to }2.5\text{ V}$ , $f = 20\text{ kHz}$ , $R_L = 50\text{ k}\Omega$ ‡	$A_V = 1$	25°C		0.2%		0.2%	
			$A_V = 10$	25°C		1%		1%	
	Gain-bandwidth product	$f = 50\text{ kHz}$ , $C_L = 100\text{ pF}$ ‡	$R_L = 50\text{ k}\Omega$ ‡,	25°C		0.2		0.2	MHz
BOM	Maximum output-swing bandwidth	$V_{O(PP)} = 2\text{ V}$ , $R_L = 50\text{ k}\Omega$ ‡,	$A_V = 1$ , $C_L = 100\text{ pF}$ ‡	25°C		30		30	kHz
$\phi_m$	Phase margin at unity gain	$R_L = 50\text{ k}\Omega$ ‡,	$C_L = 100\text{ pF}$ ‡	25°C		63°		63°	
				25°C		15		15	dB

† Full range is – 40°C to 125°C.

‡ Referenced to 2.5 V

**TLV225x, TLV225xA**  
**Advanced LinCMOS™ RAIL-TO-RAIL**  
**VERY LOW-POWER OPERATIONAL AMPLIFIERS**

SLOS185D – FEBRUARY 1997 – REVISED AUGUST 2006

**TLV2254I electrical characteristics at specified free-air temperature,  $V_{DD} = 3\text{ V}$  (unless otherwise noted)**

PARAMETER	TEST CONDITIONS	$T_A$ †	TLV2254I			TLV2254AI			UNIT
			MIN	TYP	MAX	MIN	TYP	MAX	
$V_{IO}$ Input offset voltage	$V_{DD\pm} = \pm 1.5\text{ V}$ , $V_O = 0$ , $V_{IC} = 0$ , $R_S = 50\ \Omega$	25°C		200	1500		200	850	$\mu\text{V}$
		Full range			1750			1000	
$\alpha_{V_{IO}}$ Temperature coefficient of input offset voltage		25°C to 85°C		0.5			0.5		$\mu\text{V}/^\circ\text{C}$
Input offset voltage long-term drift (see Note 4)		25°C		0.003			0.003		$\mu\text{V}/\text{mo}$
$I_{IO}$ Input offset current		25°C		0.5	60		0.5	60	$\text{pA}$
		-40°C to 85°C			150			150	
		Full range			1000			1000	
$I_{IB}$ Input bias current		25°C		1	60		1	60	$\text{pA}$
		-40°C to 85°C			150			150	
		Full range			1000			1000	
$V_{ICR}$ Common-mode input voltage range	$R_S = 50\ \Omega$ , $ V_{IO}  \leq 5\text{ mV}$	25°C	0 to 2	-0.3 to 2.2		0 to 2	-0.3 to 2.2	$\text{V}$	
		Full range			0 to 1.7				0 to 1.7
$V_{OH}$ High-level output voltage	$I_{OH} = -20\ \mu\text{A}$	25°C		2.98			2.98	$\text{V}$	
	$I_{OH} = -75\ \mu\text{A}$	25°C		2.9			2.9		
	Full range			2.8			2.8		
$V_{OL}$ Low-level output voltage	$V_{IC} = 1.5\text{ V}$ , $I_{OL} = 50\ \mu\text{A}$	25°C		10			10	$\text{mV}$	
		Full range			80				80
	$V_{IC} = 1.5\text{ V}$ , $I_{OL} = 500\ \mu\text{A}$	25°C		100			100		
		Full range			150				150
	$V_{IC} = 1.5\text{ V}$ , $I_{OL} = 1\text{ mA}$	25°C		200			200		
		Full range			300				300
$A_{VD}$ Large-signal differential voltage amplification	$V_{IC} = 1.5\text{ V}$ , $V_O = 1\text{ V to }2\text{ V}$	$R_L = 100\text{ k}\Omega$ ‡	25°C	100	225		100	225	$\text{V}/\text{mV}$
			Full range		10			10	
		$R_L = 1\text{ M}\Omega$ ‡	25°C		800			800	
$r_{i(d)}$ Differential input resistance		25°C		$10^{12}$			$10^{12}$	$\Omega$	
$r_{i(c)}$ Common-mode input resistance		25°C		$10^{12}$			$10^{12}$	$\Omega$	
$C_{i(c)}$ Common-mode input capacitance	$f = 10\text{ kHz}$ , N package	25°C		8			8	$\text{pF}$	
$Z_o$ Closed-loop output impedance	$f = 25\text{ kHz}$ , $A_V = 10$	25°C		220			220	$\Omega$	
CMRR Common-mode rejection ratio	$V_{IC} = 0\text{ to }1.7\text{ V}$ , $V_O = 1.5\text{ V}$ , $R_S = 50\ \Omega$	25°C	65	75		65	77	$\text{dB}$	
		Full range		60			60		

† Full range is -40°C to 125°C.

‡ Referenced to 1.5 V

NOTE 4: Typical values are based on the input offset voltage shift observed through 500 hours of operating life test at  $T_A = 150^\circ\text{C}$  extrapolated to  $T_A = 25^\circ\text{C}$  using the Arrhenius equation and assuming an activation energy of 0.96 eV.



**TLV225x, TLV225xA**  
**Advanced LinCMOS™ RAIL-TO-RAIL**  
**VERY LOW-POWER OPERATIONAL AMPLIFIERS**

SLOS185D – FEBRUARY 1997 – REVISED AUGUST 2006

**TLV2254I electrical characteristics at specified free-air temperature,  $V_{DD} = 3\text{ V}$  (unless otherwise noted) (continued)**

PARAMETER	TEST CONDITIONS	$T_A$ †	TLV2254I			TLV2254AI			UNIT	
			MIN	TYP	MAX	MIN	TYP	MAX		
$k_{SVR}$	Supply voltage rejection ratio ( $\Delta V_{DD}/\Delta V_{IO}$ )	$V_{DD} = 2.7\text{ V to } 8\text{ V}$ , $V_{IC} = V_{DD}/2$ , No load	25°C	80	95		80	100	dB	
			Full range	80			80			
$I_{DD}$	Supply current (four amplifiers)	$V_O = 1.5\text{ V}$ , No load	25°C		135	250		135	250	μA
			Full range			300			300	

† Full range is – 40°C to 125°C.

**TLV2254I operating characteristics at specified free-air temperature,  $V_{DD} = 3\text{ V}$**

PARAMETER	TEST CONDITIONS	$T_A$ †	TLV2254I			TLV2254AI			UNIT
			MIN	TYP	MAX	MIN	TYP	MAX	
SR	Slew rate at unity gain	$V_O = 0.7\text{ V to } 1.7\text{ V}$ , $R_L = 100\text{ k}\Omega$ ‡, $C_L = 100\text{ pF}$ ‡	25°C	0.07	0.1		0.07	0.1	V/μs
			Full range	0.05			0.05		
$V_n$	Equivalent input noise voltage	$f = 10\text{ Hz}$ $f = 1\text{ kHz}$	25°C		35			35	nV/√Hz
			25°C		19			19	
$V_{N(PP)}$	Peak-to-peak equivalent input noise voltage	$f = 0.1\text{ Hz to } 1\text{ Hz}$ $f = 0.1\text{ Hz to } 10\text{ Hz}$	25°C		0.6			0.6	μV
			25°C		1.1			1.1	
$I_n$	Equivalent input noise current		25°C		0.6			0.6	fA/√Hz
	Gain-bandwidth product	$f = 1\text{ kHz}$ , $R_L = 50\text{ k}\Omega$ ‡, $C_L = 100\text{ pF}$ ‡	25°C		0.187			0.187	MHz
$B_{OM}$	Maximum output-swing bandwidth	$V_{O(PP)} = 1\text{ V}$ , $A_V = 1$ , $R_L = 50\text{ k}\Omega$ ‡, $C_L = 100\text{ pF}$ ‡	25°C		60			60	kHz
$\phi_m$	Phase margin at unity gain	$R_L = 50\text{ k}\Omega$ ‡, $C_L = 100\text{ pF}$ ‡	25°C		63°			63°	
	Gain margin		25°C		15			15	dB

† Full range is – 40°C to 85°C.

‡ Referenced to 1.5 V

**TLV225x, TLV225xA**  
**Advanced LinCMOS™ RAIL-TO-RAIL**  
**VERY LOW-POWER OPERATIONAL AMPLIFIERS**

SLOS185D – FEBRUARY 1997 – REVISED AUGUST 2006

**TLV2254I electrical characteristics at specified free-air temperature,  $V_{DD} = 5\text{ V}$  (unless otherwise noted)**

PARAMETER	TEST CONDITIONS	$T_A$ †	TLV2254I			TLV2254AI			UNIT
			MIN	TYP	MAX	MIN	TYP	MAX	
$V_{IO}$ Input offset voltage	$V_{DD\pm} = \pm 2.5\text{ V}$ , $V_O = 0$ , $V_{IC} = 0$ , $R_S = 50\ \Omega$	25°C	200		1500	200		850	$\mu\text{V}$
		Full range	1750			1000			
$\alpha V_{IO}$ Temperature coefficient of input offset voltage		25°C to 85°C	0.5			0.5			$\mu\text{V}/^\circ\text{C}$
Input offset voltage long-term drift (see Note 4)		25°C	0.003			0.003			$\mu\text{V}/\text{mo}$
$I_{IO}$ Input offset current		25°C	0.5		60	0.5		60	$\text{pA}$
		–40°C to 85°C	150			150			
		Full range	1000			1000			
$I_{IB}$ Input bias current		25°C	1		60	1		60	$\text{pA}$
	–40°C to 85°C	150			150				
	Full range	1000			1000				
$V_{ICR}$ Common-mode input voltage range	$ V_{IO}  \leq 5\text{ mV}$ , $R_S = 50\ \Omega$	25°C	0 to 4	–0.3 to 4.2	0 to 4	–0.3 to 4.2			V
		Full range	0 to 3.5		0 to 3.5				
$V_{OH}$ High-level output voltage	$I_{OH} = -20\ \mu\text{A}$	25°C	4.98		4.98				V
	$I_{OH} = -75\ \mu\text{A}$	25°C	4.9	4.94	4.9	4.94			
	$I_{OH} = -150\ \mu\text{A}$	Full range	4.8		4.8				
		25°C	4.8	4.88	4.8	4.88			
$V_{OL}$ Low-level output voltage	$V_{IC} = 2.5\text{ V}$ , $I_{OL} = 50\ \mu\text{A}$	25°C	0.01		0.01				V
		Full range	0.06		0.06				
	$V_{IC} = 2.5\text{ V}$ , $I_{OL} = 500\ \mu\text{A}$	25°C	0.09	0.15	0.09	0.15			
		Full range	0.15		0.15				
	$V_{IC} = 2.5\text{ V}$ , $I_{OL} = 1\text{ mA}$	25°C	0.2	0.3	0.2	0.3			
		Full range	0.3		0.3				
$A_{VD}$ Large-signal differential voltage amplification	$V_{IC} = 2.5\text{ V}$ , $V_O = 1\text{ V to }4\text{ V}$	$R_L = 100\text{ k}\Omega$ ‡	25°C	100	350	100	350		
			Full range	10		10			
		$R_L = 1\text{ M}\Omega$ ‡	25°C	1700		1700			
$r_{i(d)}$ Differential input resistance		25°C	10 <sup>12</sup>		10 <sup>12</sup>				$\Omega$
$r_{i(c)}$ Common-mode input resistance		25°C	10 <sup>12</sup>		10 <sup>12</sup>				$\Omega$
$C_{i(c)}$ Common-mode input capacitance	$f = 10\text{ kHz}$ , N package	25°C	8		8				pF
$z_o$ Closed-loop output impedance	$f = 25\text{ kHz}$ , $A_V = 10$	25°C	200		200				$\Omega$
CMRR Common-mode rejection ratio	$V_{IC} = 0\text{ to }2.7\text{ V}$ , $V_O = 2.5\text{ V}$ , $R_S = 50\ \Omega$	25°C	70	83	70	83			dB
		Full range	70		70				

† Full range is –40°C to 125°C.

‡ Referenced to 2.5 V

NOTE 4: Typical values are based on the input offset voltage shift observed through 500 hours of operating life test at  $T_A = 150^\circ\text{C}$  extrapolated to  $T_A = 25^\circ\text{C}$  using the Arrhenius equation and assuming an activation energy of 0.96 eV.



**TLV225x, TLV225xA**  
**Advanced LinCMOS™ RAIL-TO-RAIL**  
**VERY LOW-POWER OPERATIONAL AMPLIFIERS**

SLOS185D – FEBRUARY 1997 – REVISED AUGUST 2006

**TLV2254I electrical characteristics at specified free-air temperature,  $V_{DD} = 5\text{ V}$  (unless otherwise noted) (continued)**

PARAMETER	TEST CONDITIONS	$T_A$ †	TLV2254I			TLV2254AI			UNIT
			MIN	TYP	MAX	MIN	TYP	MAX	
$k_{SVR}$	Supply voltage rejection ratio ( $\Delta V_{DD}/\Delta V_{IO}$ )	$V_{DD} = 4.4\text{ V to }8\text{ V}$ , $V_{IC} = V_{DD}/2$ , No load	25°C	80	95		80	95	dB
			Full range	80			80		
$I_{DD}$	Supply current (four amplifiers)	$V_O = 2.5\text{ V}$ , No load	25°C	140 250		140 250		$\mu\text{A}$	
			Full range	300			300		

† Full range is – 40°C to 125°C.

**TLV2254I operating characteristics at specified free-air temperature,  $V_{DD} = 5\text{ V}$**

PARAMETER	TEST CONDITIONS	$T_A$ †	TLV2254I			TLV2254AI			UNIT
			MIN	TYP	MAX	MIN	TYP	MAX	
SR	Slew rate at unity gain	$V_O = 1.4\text{ V to }2.6\text{ V}$ , $R_L = 100\text{ k}\Omega$ ‡, $C_L = 100\text{ pF}$ ‡	25°C	0.07	0.12		0.07	0.12	$\text{V}/\mu\text{s}$
			Full range	0.05			0.05		
$V_n$	Equivalent input noise voltage	$f = 10\text{ Hz}$ $f = 1\text{ kHz}$	25°C	36		36		$\text{nV}/\sqrt{\text{Hz}}$	
			25°C	19		19			
$V_{N(PP)}$	Peak-to-peak equivalent input noise voltage	$f = 0.1\text{ Hz to }1\text{ Hz}$ $f = 0.1\text{ Hz to }10\text{ Hz}$	25°C	0.7		0.7		$\mu\text{V}$	
			25°C	1.1		1.1			
$I_n$	Equivalent input noise current		25°C	0.6		0.6		$\text{fA}/\sqrt{\text{Hz}}$	
THD + N	Total harmonic distortion plus noise	$V_O = 0.5\text{ V to }2.5\text{ V}$ , $f = 20\text{ kHz}$ , $R_L = 50\text{ k}\Omega$ ‡	25°C	$A_V = 1$	0.2%		0.2%		
				$A_V = 10$	1%		1%		
	Gain-bandwidth product	$f = 50\text{ kHz}$ , $C_L = 100\text{ pF}$ ‡	25°C	0.2		0.2		MHz	
BOM	Maximum output-swing bandwidth	$V_{O(PP)} = 2\text{ V}$ , $R_L = 50\text{ k}\Omega$ ‡	25°C	30		30		kHz	
$\phi_m$	Phase margin at unity gain	$R_L = 50\text{ k}\Omega$ ‡, $C_L = 100\text{ pF}$ ‡	25°C	63°		63°			
			25°C	15		15			dB

† Full range is – 40°C to 125°C.

‡ Referenced to 2.5 V

**TLV225x, TLV225xA**  
**Advanced LinCMOS™ RAIL-TO-RAIL**  
**VERY LOW-POWER OPERATIONAL AMPLIFIERS**

SLOS185D – FEBRUARY 1997 – REVISED AUGUST 2006

**TLV2252Q, and TLV2252M electrical characteristics at specified free-air temperature,  $V_{DD} = 3\text{ V}$  (unless otherwise noted)**

PARAMETER	TEST CONDITIONS	$T_A$ †	TLV2252Q, TLV2252M			TLV2252AQ, TLV2252AM			UNIT
			MIN	TYP	MAX	MIN	TYP	MAX	
$V_{IO}$ Input offset voltage		25°C	200	1500		200	850	$\mu\text{V}$	
		Full range		1750		1000			
$\alpha_{VIO}$ Temperature coefficient of input offset voltage		25°C to 85°C	0.5			0.5			$\mu\text{V}/^\circ\text{C}$
Input offset voltage long-term drift (see Note 4)	$V_{DD} \pm = \pm 1.5\text{ V}$ , $V_O = 0$ , $V_{IC} = 0$ , $R_S = 50\ \Omega$	25°C	0.003			0.003			$\mu\text{V}/\text{mo}$
$I_{IO}$ Input offset current		25°C	0.5	60		0.5	60	pA	
		125°C	1000			1000			
$I_{IB}$ Input bias current		25°C	1	60		1	60	pA	
	125°C	1000			1000				
$V_{ICR}$ Common-mode input voltage range	$R_S = 50\ \Omega$ , $ V_{IO}  \leq 5\text{ mV}$	25°C	0 to 2	-0.3 to 2.2		0 to 2	-0.3 to 2.2	V	
		Full range	0 to 1.7		0 to 1.7				
$V_{OH}$ High-level output voltage	$I_{OH} = -20\ \mu\text{A}$	25°C	2.98			2.98			V
	$I_{OH} = -75\ \mu\text{A}$	25°C	2.9			2.9			
	$I_{OH} = -150\ \mu\text{A}$	Full range	2.8			2.8			
		25°C	2.8			2.8			
$V_{OL}$ Low-level output voltage	$V_{IC} = 1.5\text{ V}$ , $I_{OL} = 50\ \mu\text{A}$	25°C	10			10			mV
		25°C	100	150		100	150		
	$V_{IC} = 1.5\text{ V}$ , $I_{OL} = 500\ \mu\text{A}$	Full range	165			165			
		25°C	200	300		200	300		
		Full range	300			300			
$A_{VD}$ Large-signal differential voltage amplification	$V_{IC} = 1.5\text{ V}$ , $V_O = 1\text{ V to }2\text{ V}$	25°C	$R_L = 100\ \text{k}\Omega$ ‡			100 250			V/mV
			Full range			10			
		25°C	$R_L = 1\ \text{M}\Omega$ ‡			800			
$r_{i(d)}$ Differential input resistance		25°C	10 <sup>12</sup>			10 <sup>12</sup>			$\Omega$
$r_{i(c)}$ Common-mode input resistance		25°C	10 <sup>12</sup>			10 <sup>12</sup>			$\Omega$
$C_{i(c)}$ Common-mode input capacitance	$f = 10\ \text{kHz}$ , P package	25°C	8			8			pF
$z_o$ Closed-loop output impedance	$f = 25\ \text{kHz}$ , $A_V = 10$	25°C	220			220			$\Omega$
CMRR Common-mode rejection ratio	$V_{IC} = 0\text{ to }1.7\text{ V}$ , $V_O = 1.5\text{ V}$ , $R_S = 50\ \Omega$	25°C	65	75		65	77	dB	
		Full range	60			60			
$k_{SVR}$ Supply voltage rejection ratio ( $\Delta V_{DD} / \Delta V_{IO}$ )	$V_{DD} = 2.7\text{ V to }8\text{ V}$ , $V_{IC} = V_{DD}/2$ , No load	25°C	80	95		80	100	dB	
		Full range	80			80			
$I_{DD}$ Supply current	$V_O = 1.5\text{ V}$ , No load	25°C	68	125		68	125	$\mu\text{A}$	
		Full range	150			150			

† Full range is -40°C to 125°C for Q level part, -55°C to 125°C for M level part.

‡ Referenced to 1.5 V

NOTE 4: Typical values are based on the input offset voltage shift observed through 500 hours of operating life test at  $T_A = 150^\circ\text{C}$  extrapolated to  $T_A = 25^\circ\text{C}$  using the Arrhenius equation and assuming an activation energy of 0.96 eV.



**TLV225x, TLV225xA**  
**Advanced LinCMOS™ RAIL-TO-RAIL**  
**VERY LOW-POWER OPERATIONAL AMPLIFIERS**

SLOS185D – FEBRUARY 1997 – REVISED AUGUST 2006

**TLV2252Q, and TLV2252M operating characteristics at specified free-air temperature,  $V_{DD} = 3\text{ V}$**

PARAMETER	TEST CONDITIONS	$T_A$ †	TLV2252Q, TLV2252M			TLV2252AQ, TLV2252AM			UNIT	
			MIN	TYP	MAX	MIN	TYP	MAX		
SR	Slew rate at unity gain $V_O = 0.8\text{ V to }1.4\text{ V}, R_L = 100\text{ k}\Omega\ddagger,$ $C_L = 100\text{ pF}\ddagger$	25°C	0.07	0.1		0.07	0.1		V/ $\mu$ s	
		Full range	0.05			0.05				
$V_n$	Equivalent input noise voltage	f = 10 Hz	25°C			35			nV/ $\sqrt{\text{Hz}}$	
		f = 1 kHz	25°C			19				
$V_{N(PP)}$	Peak-to-peak equivalent input noise voltage	f = 0.1 Hz to 1 Hz	25°C			0.6			$\mu$ V	
		f = 0.1 Hz to 10 Hz	25°C			1.1				
$I_n$	Equivalent input noise current	25°C	0.6			0.6			fA/ $\sqrt{\text{Hz}}$	
	Gain-bandwidth product	f = 1 kHz, $R_L = 50\text{ k}\Omega\ddagger,$ $C_L = 100\text{ pF}\ddagger$	25°C			0.187			MHz	
$B_{OM}$	Maximum output-swing bandwidth	$V_{O(PP)} = 1\text{ V},$ $R_L = 50\text{ k}\Omega\ddagger,$	$A_V = 1,$ $C_L = 100\text{ pF}\ddagger$	25°C			60			kHz
$\phi_m$	Phase margin at unity gain	$R_L = 50\text{ k}\Omega\ddagger,$	$C_L = 100\text{ pF}\ddagger$	25°C			63°			
	Gain margin			25°C			15			dB

† Full range is  $-40^\circ\text{C}$  to  $125^\circ\text{C}$  for Q level part,  $-55^\circ\text{C}$  to  $125^\circ\text{C}$  for M level part.

‡ Referenced to 1.5 V

**TLV225x, TLV225xA**  
**Advanced LinCMOS™ RAIL-TO-RAIL**  
**VERY LOW-POWER OPERATIONAL AMPLIFIERS**

SLOS185D – FEBRUARY 1997 – REVISED AUGUST 2006

**TLV2252Q, and TLV2252M electrical characteristics at specified free-air temperature,  $V_{DD} = 5\text{ V}$  (unless otherwise noted)**

PARAMETER	TEST CONDITIONS	$T_A$ †	TLV2252Q, TLV2252M			TLV2252AQ, TLV2252AM			UNIT
			MIN	TYP	MAX	MIN	TYP	MAX	
$V_{IO}$ Input offset voltage	$V_{DD} \pm \pm 2.5\text{ V}, V_{IC} = 0, V_O = 0, R_S = 50\ \Omega$	25°C	200	1500		200	850	$\mu\text{V}$	
		Full range		1750		1000			
$\alpha_{VIO}$ Temperature coefficient of input offset voltage		25°C to 85°C	0.5			0.5			$\mu\text{V}/^\circ\text{C}$
Input offset voltage long-term drift (see Note 4)		25°C	0.003			0.003			$\mu\text{V}/\text{mo}$
$I_{IO}$ Input offset current		25°C	0.5	60		0.5	60	pA	
		125°C	1000			1000			
$I_{IB}$ Input bias current	25°C	1	60		1	60	pA		
	125°C	1000			1000				
$V_{ICR}$ Common-mode input voltage range	$ V_{IO}  \leq 5\text{ mV}, R_S = 50\ \Omega$	25°C	0 to 4	-0.3 to 4.2		0 to 4	-0.3 to 4.2	V	
		Full range	0 to 3.5		0 to 3.5				
$V_{OH}$ High-level output voltage	$I_{OH} = -20\ \mu\text{A}$	25°C	4.98			4.98			V
	$I_{OH} = -75\ \mu\text{A}$	25°C	4.9	4.94		4.9	4.94		
	Full range	4.8			4.8				
$V_{OL}$ Low-level output voltage	$I_{OH} = -150\ \mu\text{A}$	25°C	4.8	4.88		4.8	4.88	V	
	$V_{IC} = 2.5\text{ V}, I_{OL} = 50\ \mu\text{A}$	25°C	0.01			0.01			
		Full range	0.09 0.15			0.09 0.15			
	$V_{IC} = 2.5\text{ V}, I_{OL} = 500\ \mu\text{A}$	25°C	0.09 0.15			0.09 0.15			
Full range		0.15			0.15				
$V_{IC} = 2.5\text{ V}, I_{OL} = 1\text{ mA}$	25°C	0.2	0.3		0.2	0.3	V		
	Full range	0.3			0.3				
$A_{VD}$ Large-signal differential voltage amplification	$V_{IC} = 2.5\text{ V}, V_O = 1\text{ V to }4\text{ V}$	$R_L = 100\text{ k}\Omega$ ‡	25°C	100	350		100	350	V/mV
			Full range	10			10		
		$R_L = 1\text{ M}\Omega$ ‡	25°C	1700			1700		
$r_{i(d)}$ Differential input resistance		25°C	$10^{12}$			$10^{12}$			$\Omega$
$r_{i(c)}$ Common-mode input resistance		25°C	$10^{12}$			$10^{12}$			$\Omega$
$C_{i(c)}$ Common-mode input capacitance	$f = 10\text{ kHz}, \text{ P package}$	25°C	8			8			pF
$z_o$ Closed-loop output impedance	$f = 25\text{ kHz}, A_V = 10$	25°C	200			200			$\Omega$
CMRR Common-mode rejection ratio	$V_{IC} = 0\text{ to }2.7\text{ V}, V_O = 2.5\text{ V}, R_S = 50\ \Omega$	25°C	70	83		70	83	dB	
		Full range	70			70			
$k_{SVR}$ Supply voltage rejection ratio ( $\Delta V_{DD}/\Delta V_{IO}$ )	$V_{DD} = 4.4\text{ V to }8\text{ V}, V_{IC} = V_{DD}/2, \text{ No load}$	25°C	80	95		80	95	dB	
		Full range	80			80			

† Full range is  $-40^\circ\text{C}$  to  $125^\circ\text{C}$  for Q level part,  $-55^\circ\text{C}$  to  $125^\circ\text{C}$  for M level part.

‡ Referenced to 2.5 V

NOTE 4: Typical values are based on the input offset voltage shift observed through 500 hours of operating life test at  $T_A = 150^\circ\text{C}$  extrapolated to  $T_A = 25^\circ\text{C}$  using the Arrhenius equation and assuming an activation energy of 0.96 eV.



**TLV225x, TLV225xA**  
**Advanced LinCMOS™ RAIL-TO-RAIL**  
**VERY LOW-POWER OPERATIONAL AMPLIFIERS**

SLOS185D – FEBRUARY 1997 – REVISED AUGUST 2006

**TLV2252Q, and TLV2252M electrical characteristics at specified free-air temperature,  $V_{DD} = 5\text{ V}$  (unless otherwise noted) (continued)**

PARAMETER	TEST CONDITIONS	$T_A$ †	TLV2252Q, TLV2252M			TLV2252AQ, TLV2252AM			UNIT
			MIN	TYP	MAX	MIN	TYP	MAX	
$I_{DD}$ Supply current	$V_O = 2.5\text{ V}$ , No load	25°C		70	125		70	125	$\mu\text{A}$
		Full range			150			150	

† Full range is  $-40^\circ\text{C}$  to  $125^\circ\text{C}$  for Q level part,  $-55^\circ\text{C}$  to  $125^\circ\text{C}$  for M level part.

**TLV2252Q, and TLV2252M operating characteristics at specified free-air temperature,  $V_{DD} = 5\text{ V}$**

PARAMETER	TEST CONDITIONS	$T_A$ †	TLV2252Q, TLV2252M			TLV2252AQ, TLV2252AM			UNIT
			MIN	TYP	MAX	MIN	TYP	MAX	
SR Slew rate at unity gain	$V_O = 1.25\text{ V}$ to $2.75\text{ V}$ , $R_L = 100\text{ k}\Omega$ ‡, $C_L = 100\text{ pF}$ ‡	25°C	0.07	0.12		0.07	0.12		$\text{V}/\mu\text{s}$
		Full range	0.05			0.05			
$V_n$ Equivalent input noise voltage	$f = 10\text{ Hz}$ $f = 1\text{ kHz}$	25°C		36			36		$\text{nV}/\sqrt{\text{Hz}}$
		25°C		19			19		
$V_{N(PP)}$ Peak-to-peak equivalent input noise voltage	$f = 0.1\text{ Hz}$ to $1\text{ Hz}$ $f = 0.1\text{ Hz}$ to $10\text{ Hz}$	25°C		0.7			0.7		$\mu\text{V}$
		25°C		1.1			1.1		
$I_n$ Equivalent input noise current		25°C		0.6			0.6	$\text{fA}/\sqrt{\text{Hz}}$	
THD + N Total harmonic distortion plus noise	$V_O = 0.5\text{ V}$ to $2.5\text{ V}$ , $f = 20\text{ kHz}$ , $R_L = 50\text{ k}\Omega$ ‡	$A_V = 1$		0.2%			0.2%		
		$A_V = 10$		1%			1%		
Gain-bandwidth product	$f = 50\text{ kHz}$ , $C_L = 100\text{ pF}$ ‡	$R_L = 50\text{ k}\Omega$ ‡, 25°C		0.2			0.2	MHz	
$B_{OM}$ Maximum output-swing bandwidth	$V_{O(PP)} = 2\text{ V}$ , $R_L = 50\text{ k}\Omega$ ‡	$A_V = 1$ , $C_L = 100\text{ pF}$ ‡, 25°C		30			30	kHz	
$\phi_m$ Phase margin at unity gain	$R_L = 50\text{ k}\Omega$ ‡, $C_L = 100\text{ pF}$ ‡	25°C		63°			63°		
Gain margin		25°C		15			15	dB	

† Full range is  $-40^\circ\text{C}$  to  $125^\circ\text{C}$  for Q level part,  $-55^\circ\text{C}$  to  $125^\circ\text{C}$  for M level part.

‡ Referenced to  $2.5\text{ V}$

**TLV225x, TLV225xA**  
**Advanced LinCMOS™ RAIL-TO-RAIL**  
**VERY LOW-POWER OPERATIONAL AMPLIFIERS**

SLOS185D – FEBRUARY 1997 – REVISED AUGUST 2006

**TLV2254Q, and TLV2254M electrical characteristics at specified free-air temperature,  $V_{DD} = 3\text{ V}$  (unless otherwise noted)**

PARAMETER	TEST CONDITIONS	$T_A$ †	TLV2254Q, TLV2254M			TLV2254AQ, TLV2254AM			UNIT
			MIN	TYP	MAX	MIN	TYP	MAX	
$V_{IO}$ Input offset voltage		25°C	200	1500		200	850	$\mu\text{V}$	
		Full range		1750		1000			
$\alpha_{VIO}$ Temperature coefficient of input offset voltage		25°C to 125°C	0.5			0.5			$\mu\text{V}/^\circ\text{C}$
Input offset voltage long-term drift (see Note 4)	$V_{DD\pm} = \pm 1.5\text{ V}$ , $V_O = 0$ , $V_{IC} = 0$ , $R_S = 50\ \Omega$	25°C	0.003			0.003			$\mu\text{V}/\text{mo}$
$I_{IO}$ Input offset current		25°C	0.5	60		0.5	60	pA	
		125°C	1000			1000			
$I_{IB}$ Input bias current		25°C	1	60		1	60	pA	
		125°C	1000			1000			
$V_{ICR}$ Common-mode input voltage range		$R_S = 50\ \Omega$ , $ V_{IO}  \leq 5\text{ mV}$	25°C	0 to 2	-0.3 to 2.2		0 to 2	-0.3 to 2.2	V
	Full range		0 to 1.7		0 to 1.7				
$V_{OH}$ High-level output voltage	$I_{OH} = -20\ \mu\text{A}$	25°C	2.98			2.98			V
	$I_{OH} = -75\ \mu\text{A}$	25°C	2.9			2.9			
	Full range	2.8			2.8				
$V_{OL}$ Low-level output voltage	$I_{OH} = -150\ \mu\text{A}$	25°C	2.8			2.8			mV
	$V_{IC} = 1.5\text{ V}$ , $I_{OL} = 50\ \mu\text{A}$	25°C	10			10			
	$V_{IC} = 1.5\text{ V}$ , $I_{OL} = 500\ \mu\text{A}$	25°C	100	150		100	150		
		Full range	165			165			
	$V_{IC} = 1.5\text{ V}$ , $I_{OL} = 1\text{ mA}$	25°C	200	300		200	300		
Full range		300			300				
$AVD$ Large-signal differential voltage amplification	$V_{IC} = 1.5\text{ V}$ , $V_O = 1\text{ V to }2\text{ V}$	$R_L = 100\text{ k}\Omega$ ‡	25°C	100	225		100	225	V/mV
			Full range	10			10		
		$R_L = 1\text{ M}\Omega$ ‡	25°C	800			800		
$r_{i(d)}$ Differential input resistance		25°C	$10^{12}$			$10^{12}$			$\Omega$
$r_{i(c)}$ Common-mode input resistance		25°C	$10^{12}$			$10^{12}$			$\Omega$
$C_{i(c)}$ Common-mode input capacitance	$f = 10\text{ kHz}$ , N package	25°C	8			8			pF
$z_o$ Closed-loop output impedance	$f = 25\text{ kHz}$ , $A_V = 10$	25°C	220			220			$\Omega$
CMRR Common-mode rejection ratio	$V_{IC} = 0\text{ to }1.7\text{ V}$ , $V_O = 1.5\text{ V}$ , $R_S = 50\ \Omega$	25°C	65	75		65	77	dB	
		Full range	60			60			
$k_{SVR}$ Supply voltage rejection ratio ( $\Delta V_{DD}/\Delta V_{IO}$ )	$V_{DD} = 2.7\text{ V to }8\text{ V}$ , $V_{IC} = V_{DD}/2$ , No load	25°C	80	95		80	100	dB	
		Full range	80			80			

† Full range is  $-40^\circ\text{C}$  to  $125^\circ\text{C}$  for Q level part,  $-55^\circ\text{C}$  to  $125^\circ\text{C}$  for M level part.

‡ Referenced to 1.5 V

NOTE 4: Typical values are based on the input offset voltage shift observed through 500 hours of operating life test at  $T_A = 150^\circ\text{C}$  extrapolated to  $T_A = 25^\circ\text{C}$  using the Arrhenius equation and assuming an activation energy of 0.96 eV.



**TLV225x, TLV225xA**  
**Advanced LinCMOS™ RAIL-TO-RAIL**  
**VERY LOW-POWER OPERATIONAL AMPLIFIERS**

SLOS185D – FEBRUARY 1997 – REVISED AUGUST 2006

**TLV2254Q, and TLV2254M electrical characteristics at specified free-air temperature,  $V_{DD} = 3\text{ V}$  (unless otherwise noted) (continued)**

PARAMETER	TEST CONDITIONS	$T_A$ †	TLV2254Q, TLV2254M			TLV2254AQ, TLV2254AM			UNIT
			MIN	TYP	MAX	MIN	TYP	MAX	
$I_{DD}$	Supply current (four amplifiers)	$V_O = 1.5\text{ V}$ , No load	25°C	135	250	135	250	$\mu\text{A}$	
			Full range	300			300		

† Full range is  $-40^\circ\text{C}$  to  $125^\circ\text{C}$  for Q level part,  $-55^\circ\text{C}$  to  $125^\circ\text{C}$  for M level part.

**TLV2254Q, and TLV2254M operating characteristics at specified free-air temperature,  $V_{DD} = 3\text{ V}$**

PARAMETER	TEST CONDITIONS	$T_A$ †	TLV2254Q, TLV2254M			TLV2254AQ, TLV2254AM			UNIT	
			MIN	TYP	MAX	MIN	TYP	MAX		
SR	Slew rate at unity gain	$V_O = 0.5\text{ V}$ to $1.7\text{ V}$ , $R_L = 100\text{ k}\Omega$ ‡, $C_L = 100\text{ pF}$ ‡	25°C	0.07	0.1	0.07	0.1	$\text{V}/\mu\text{s}$		
			Full range	0.05			0.05			
$V_n$	Equivalent input noise voltage	$f = 10\text{ Hz}$	25°C	35			35			$\text{nV}/\sqrt{\text{Hz}}$
			25°C	19			19			
$V_{N(PP)}$	Peak-to-peak equivalent input noise voltage	$f = 0.1\text{ Hz}$ to $1\text{ Hz}$	25°C	0.6			0.6			$\mu\text{V}$
			25°C	1.1			1.1			
$I_n$	Equivalent input noise current	$f = 0.1\text{ Hz}$ to $10\text{ Hz}$	25°C	0.6			0.6			$\text{fA}/\sqrt{\text{Hz}}$
	Gain-bandwidth product	$f = 1\text{ kHz}$ , $R_L = 50\text{ k}\Omega$ ‡, $C_L = 100\text{ pF}$ ‡	25°C	0.187			0.187			MHz
BOM	Maximum output-swing bandwidth	$V_{O(PP)} = 1\text{ V}$ , $A_V = 1$ , $R_L = 50\text{ k}\Omega$ ‡, $C_L = 100\text{ pF}$ ‡	25°C	60			60			kHz
$\phi_m$	Phase margin at unity gain	$R_L = 50\text{ k}\Omega$ ‡, $C_L = 100\text{ pF}$ ‡	25°C	63°			63°			
	Gain margin		25°C	15			15			dB

† Full range is  $-40^\circ\text{C}$  to  $125^\circ\text{C}$  for Q level part,  $-55^\circ\text{C}$  to  $125^\circ\text{C}$  for M level part.

‡ Referenced to  $1.5\text{ V}$

**TLV225x, TLV225xA**  
**Advanced LinCMOS™ RAIL-TO-RAIL**  
**VERY LOW-POWER OPERATIONAL AMPLIFIERS**

SLOS185D – FEBRUARY 1997 – REVISED AUGUST 2006

**TLV2254Q, and TLV2254M electrical characteristics at specified free-air temperature,  $V_{DD} = 5\text{ V}$  (unless otherwise noted)**

PARAMETER	TEST CONDITIONS	$T_A$ †	TLV2254Q, TLV2254M			TLV2254AQ, TLV2254AM			UNIT
			MIN	TYP	MAX	MIN	TYP	MAX	
$V_{IO}$ Input offset voltage	$V_{DD\pm} = \pm 2.5\text{ V}$ , $V_O = 0$ , $V_{IC} = 0$ , $R_S = 50\ \Omega$	25°C	200	1500		200	850	$\mu\text{V}$	
		Full range			1750		1000		
$\alpha_{VIO}$ Temperature coefficient of input offset voltage		25°C to 125°C	0.5			0.5			$\mu\text{V}/^\circ\text{C}$
Input offset voltage long-term drift (see Note 4)		25°C	0.003			0.003			$\mu\text{V}/\text{mo}$
$I_{IO}$ Input offset current		25°C	0.5	60		0.5	60	pA	
		125°C			1000		1000		
$I_{IB}$ Input bias current	25°C	1	60		1	60	pA		
	125°C			1000		1000			
$V_{ICR}$ Common-mode input voltage range	$ V_{IO}  \leq 5\text{ mV}$ , $R_S = 50\ \Omega$	25°C	0 to 4	-0.3 to 4.2		0 to 4	-0.3 to 4.2	V	
		Full range	0 to 3.5			0 to 3.5			
$V_{OH}$ High-level output voltage	$I_{OH} = -20\ \mu\text{A}$	25°C	4.98		4.98		V		
		25°C	4.9	4.94	4.9	4.94			
		Full range	4.8		4.8				
		25°C	4.8	4.88	4.8	4.88			
$V_{OL}$ Low-level output voltage	$V_{IC} = 2.5\text{ V}$ , $I_{OL} = 50\ \mu\text{A}$	25°C	0.01		0.01		V		
		25°C	0.09	0.15	0.09	0.15			
	Full range	0.15		0.15					
		25°C	0.2	0.3	0.2	0.3			
	Full range	0.3		0.3					
		25°C	100	350	100	350			
$A_{VD}$ Large-signal differential voltage amplification	$V_{IC} = 2.5\text{ V}$ , $V_O = 1\text{ V to }4\text{ V}$	$R_L = 100\text{ k}\Omega$ ‡	10		10		V/mV		
		Full range	10		10				
		$R_L = 1\text{ M}\Omega$ ‡	1700		1700				
$r_{i(d)}$ Differential input resistance		25°C	10 <sup>12</sup>		10 <sup>12</sup>		$\Omega$		
$r_{i(c)}$ Common-mode input resistance		25°C	10 <sup>12</sup>		10 <sup>12</sup>		$\Omega$		
$c_{i(c)}$ Common-mode input capacitance	$f = 10\text{ kHz}$ , N package	25°C	8		8		pF		
$z_o$ Closed-loop output impedance	$f = 25\text{ kHz}$ , $A_V = 10$	25°C	200		200		$\Omega$		
CMRR Common-mode rejection ratio	$V_{IC} = 0\text{ to }2.7\text{ V}$ , $V_O = 2.5\text{ V}$ , $R_S = 50\ \Omega$	25°C	70	83	70	83	dB		
		Full range	70		70				
$k_{SVR}$ Supply voltage rejection ratio ( $\Delta V_{DD}/\Delta V_{IO}$ )	$V_{DD} = 4.4\text{ V to }8\text{ V}$ , $V_{IC} = V_{DD}/2$ , No load	25°C	80	95	80	95	dB		
		Full range	80		80				

† Full range is -40°C to 125°C for Q level part, -55°C to 125°C for M level part.

‡ Referenced to 2.5 V

NOTE 4: Typical values are based on the input offset voltage shift observed through 500 hours of operating life test at  $T_A = 150^\circ\text{C}$  extrapolated to  $T_A = 25^\circ\text{C}$  using the Arrhenius equation and assuming an activation energy of 0.96 eV.



**TLV225x, TLV225xA**  
**Advanced LinCMOS™ RAIL-TO-RAIL**  
**VERY LOW-POWER OPERATIONAL AMPLIFIERS**

SLOS185D – FEBRUARY 1997 – REVISED AUGUST 2006

**TLV2254Q, and TLV2254M electrical characteristics at specified free-air temperature,  $V_{DD} = 5\text{ V}$  (unless otherwise noted) (continued)**

PARAMETER	TEST CONDITIONS	$T_A$ †	TLV2254Q, TLV2254M			TLV2254AQ, TLV2254AM			UNIT
			MIN	TYP	MAX	MIN	TYP	MAX	
$I_{DD}$	Supply current (four amplifiers)	$V_O = 2.5\text{ V}$ , No load	25°C	140	250	140	250	$\mu\text{A}$	
			Full range	300			300		

† Full range is  $-40^\circ\text{C}$  to  $125^\circ\text{C}$  for Q level part,  $-55^\circ\text{C}$  to  $125^\circ\text{C}$  for M level part.

**TLV2254Q, and TLV2254M operating characteristics at specified free-air temperature,  $V_{DD} = 5\text{ V}$**

PARAMETER	TEST CONDITIONS	$T_A$ †	TLV2254Q, TLV2254M			TLV2254AQ, TLV2254AM			UNIT	
			MIN	TYP	MAX	MIN	TYP	MAX		
SR	Slew rate at unity gain $V_O = 0.5\text{ V to }3.5\text{ V}$ , $R_L = 100\text{ k}\Omega$ ‡, $C_L = 100\text{ pF}$ ‡	25°C	0.07	0.12		0.07	0.12	$\text{V}/\mu\text{s}$		
		Full range	0.05			0.05				
$V_n$	Equivalent input noise voltage	$f = 10\text{ Hz}$	36			36			$\text{nV}/\sqrt{\text{Hz}}$	
		$f = 1\text{ kHz}$	19			19				
$V_{N(PP)}$	Peak-to-peak equivalent input noise voltage	$f = 0.1\text{ Hz to }1\text{ Hz}$	0.7			0.7			$\mu\text{V}$	
		$f = 0.1\text{ Hz to }10\text{ Hz}$	1.1			1.1				
$I_n$	Equivalent input noise current	25°C	0.6			0.6			$\text{fA}/\sqrt{\text{Hz}}$	
THD + N	Total harmonic distortion plus noise $V_O = 0.5\text{ V to }2.5\text{ V}$ , $f = 20\text{ kHz}$ , $R_L = 50\text{ k}\Omega$ ‡	$A_V = 1$	0.2%			0.2%				
		$A_V = 10$	1%			1%				
	Gain-bandwidth product $f = 50\text{ kHz}$ , $C_L = 100\text{ pF}$ ‡	$R_L = 50\text{ k}\Omega$ ‡, 25°C	0.2			0.2			MHz	
BOM	Maximum output-swing bandwidth $V_{O(PP)} = 2\text{ V}$ , $R_L = 50\text{ k}\Omega$ ‡	$A_V = 1$ , $C_L = 100\text{ pF}$ ‡	25°C	30			30			kHz
$\phi_m$	Phase margin at unity gain $R_L = 50\text{ k}\Omega$ ‡	$C_L = 100\text{ pF}$ ‡	25°C	63°			63°			
			Gain margin	25°C	15			15		

† Full range is  $-40^\circ\text{C}$  to  $125^\circ\text{C}$  for Q level part,  $-55^\circ\text{C}$  to  $125^\circ\text{C}$  for M level part.

‡ Referenced to 2.5 V

**TLV225x, TLV225xA**  
**Advanced LinCMOS™ RAIL-TO-RAIL**  
**VERY LOW-POWER OPERATIONAL AMPLIFIERS**  
 SLOS185D – FEBRUARY 1997 – REVISED AUGUST 2006

**TYPICAL CHARACTERISTICS**

**Table of Graphs**

		FIGURE
$V_{IO}$	Input offset voltage	Distribution vs Common-mode voltage 2 – 5 6, 7
$\alpha V_{IO}$	Input offset voltage temperature coefficient	Distribution 8 – 11
$I_{IB}/I_{IO}$	Input bias and input offset currents	vs Free-air temperature 12
$V_I$	Input voltage	vs Supply voltage vs Free-air temperature 13 14
$V_{OH}$	High-level output voltage	vs High-level output current 15, 18
$V_{OL}$	Low-level output voltage	vs Low-level output current 16, 17, 19
$V_{O(PP)}$	Maximum peak-to-peak output voltage	vs Frequency 20
$I_{OS}$	Short-circuit output current	vs Supply voltage vs Free-air temperature 21 22
$V_{ID}$	Differential input voltage	vs Output voltage 23, 24
$A_{VD}$	Differential voltage amplification	vs Load resistance 25
$A_{VD}$	Large-signal differential voltage amplification	vs Frequency vs Free-air temperature 26, 27 28, 29
$z_o$	Output impedance	vs Frequency 30, 31
CMRR	Common-mode rejection ratio	vs Frequency vs Free-air temperature 32 33
$k_{SVR}$	Supply-voltage rejection ratio	vs Frequency vs Free-air temperature 34, 35 36
$I_{DD}$	Supply current	vs Supply voltage 37, 38
SR	Slew rate	vs Load capacitance vs Free-air temperature 39 40
$V_O$	Inverting large-signal pulse response	41, 42
$V_O$	Voltage-follower large-signal pulse response	43, 44
$V_O$	Inverting small-signal pulse response	45, 46
$V_O$	Voltage-follower small-signal pulse response	47, 48
$V_n$	Equivalent input noise voltage	vs Frequency 49, 50
	Input noise voltage	Over a 10-second period 51
	Integrated noise voltage	vs Frequency 52
THD + N	Total harmonic distortion plus noise	vs Frequency 53
	Gain-bandwidth product	vs Supply voltage vs Free-air temperature 54 55
$\phi_m$	Phase margin	vs Frequency vs Load capacitance 26, 27 56
	Gain margin	vs Load capacitance 57
$B_1$	Unity-gain bandwidth	vs Load capacitance 58
	Overestimation of phase margin	vs Load capacitance 59



**TYPICAL CHARACTERISTICS**

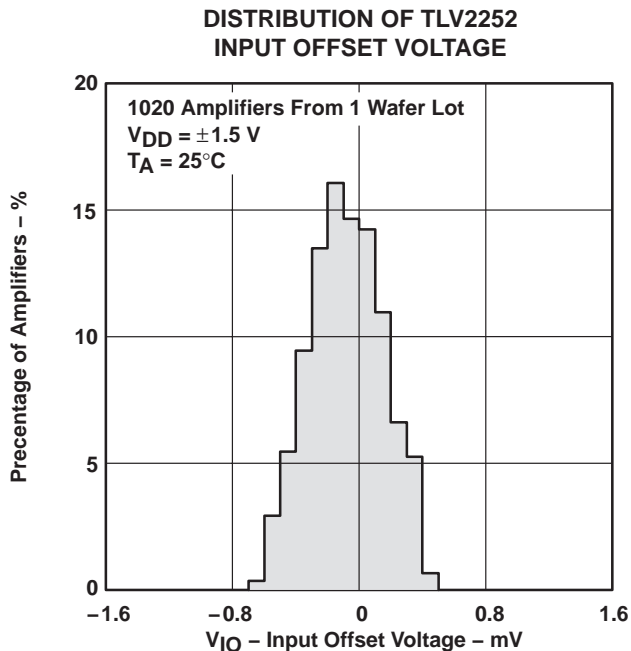

**Figure 2**

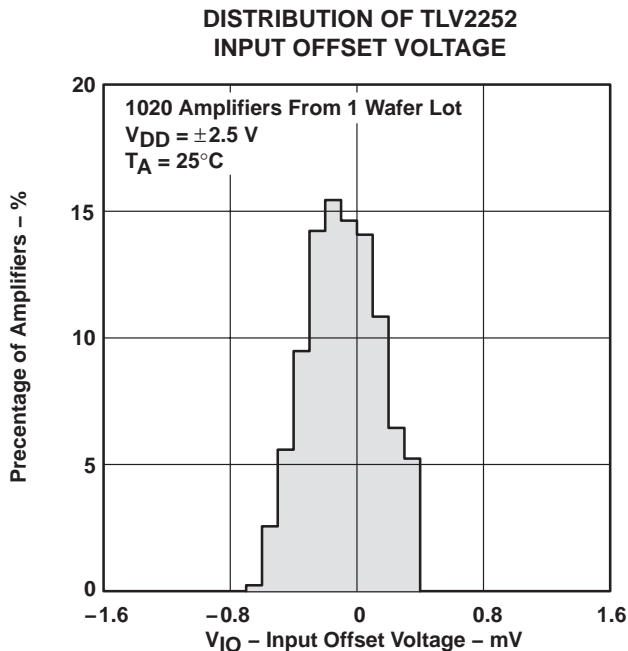

**Figure 3**

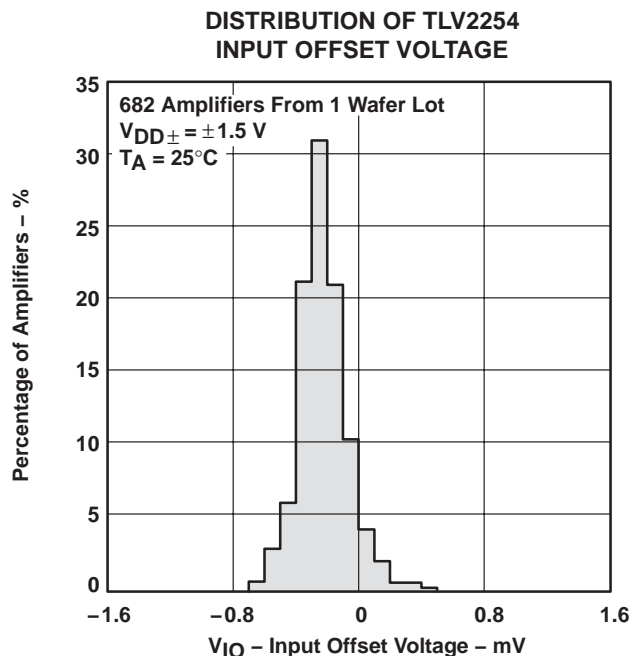

**Figure 4**

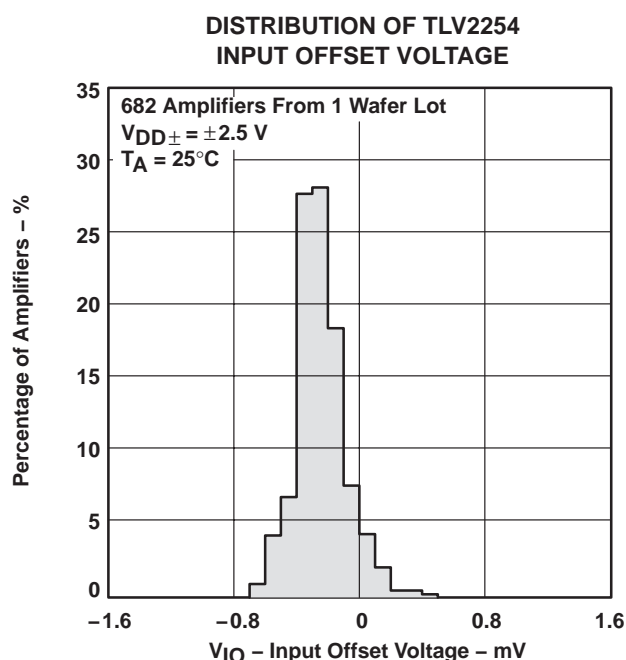
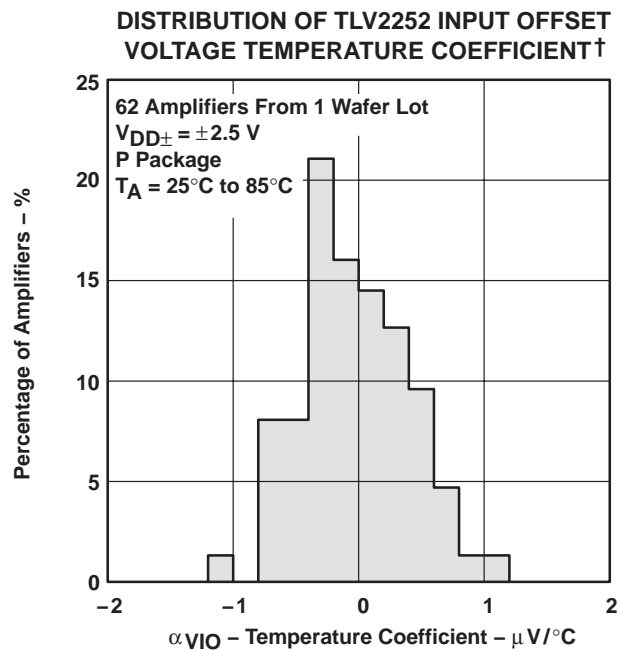
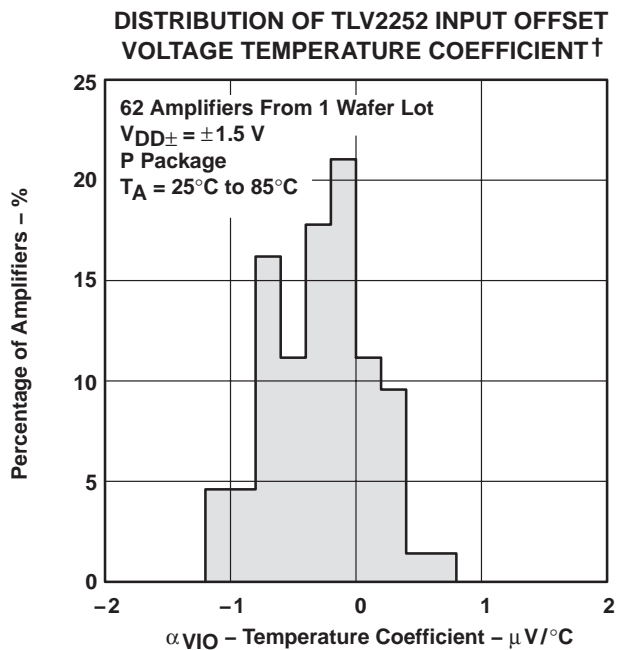
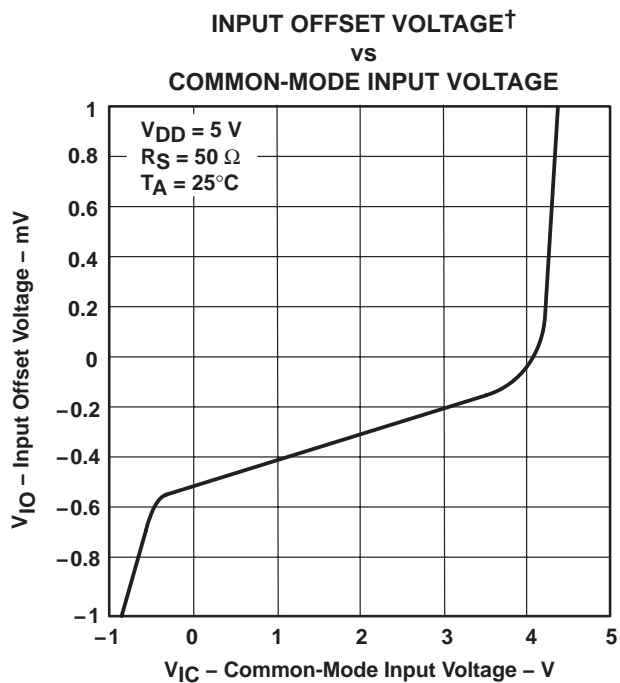
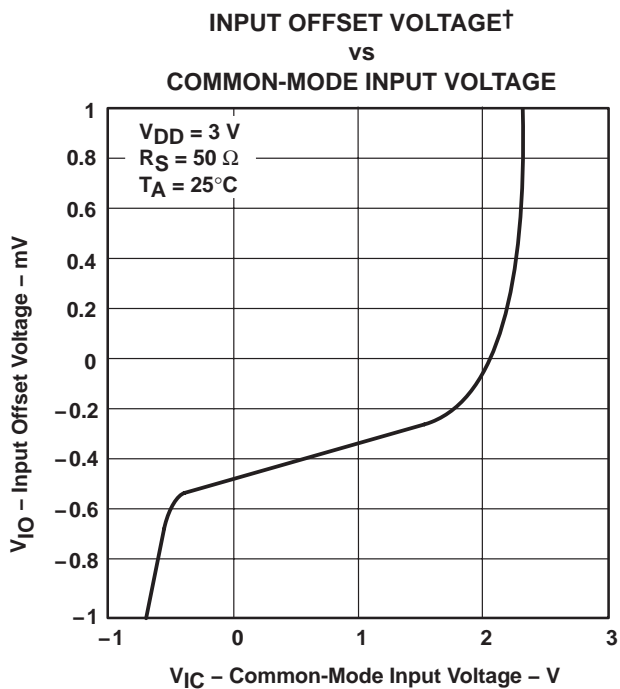

**Figure 5**

**TLV225x, TLV225xA**  
**Advanced LinCMOS™ RAIL-TO-RAIL**  
**VERY LOW-POWER OPERATIONAL AMPLIFIERS**

SLOS185D – FEBRUARY 1997 – REVISED AUGUST 2006

**TYPICAL CHARACTERISTICS**



† For all curves where  $V_{DD} = 5\text{ V}$ , all loads are referenced to 2.5 V. For all curves where  $V_{DD} = 3\text{ V}$ , all loads are referenced to 1.5 V.

**TYPICAL CHARACTERISTICS**

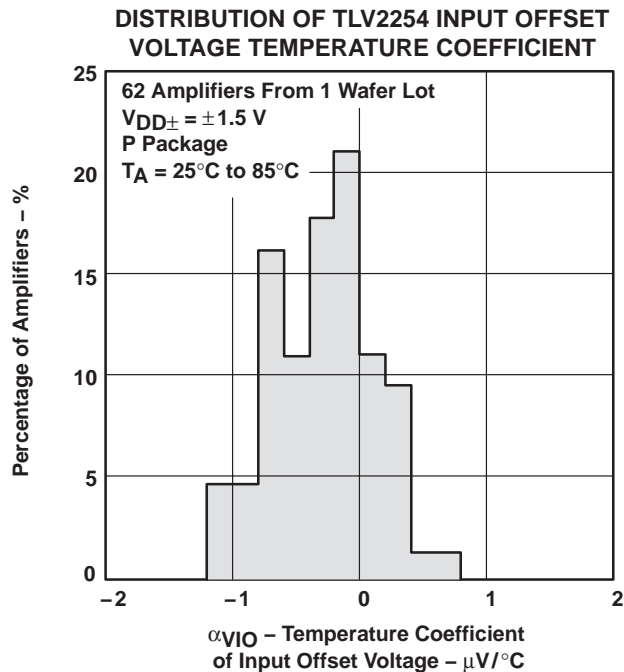

**Figure 10**

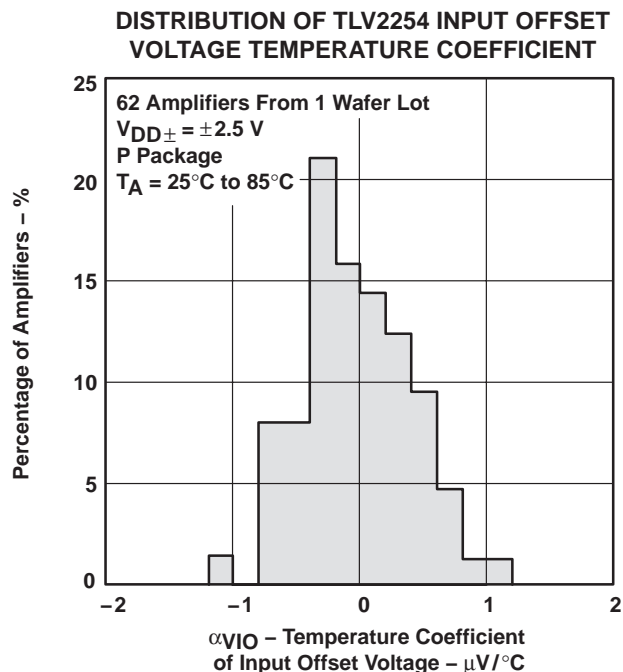

**Figure 11**

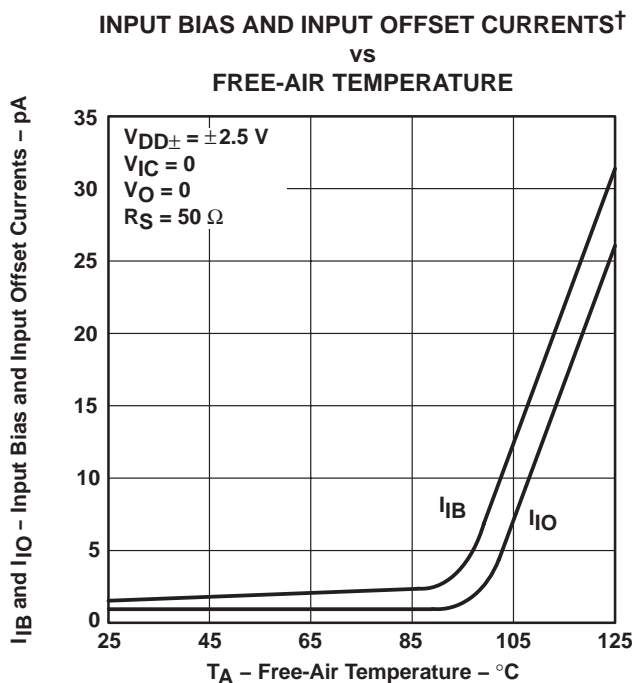

**Figure 12**

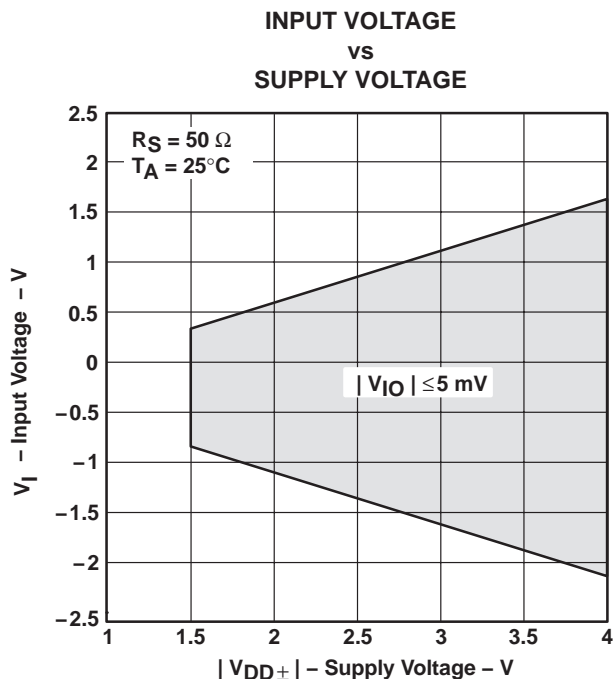

**Figure 13**

† Data at high and low temperatures are applicable only within the rated operating free-air temperature ranges of the various devices.

**TYPICAL CHARACTERISTICS**

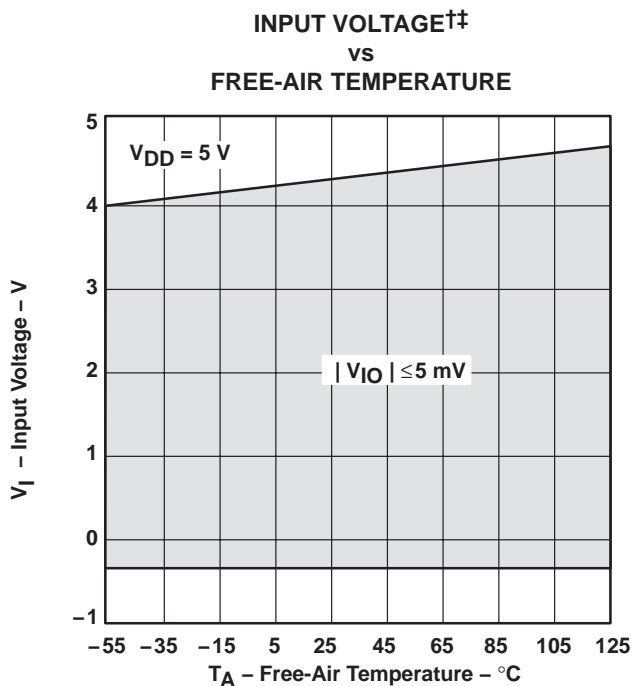

**Figure 14**

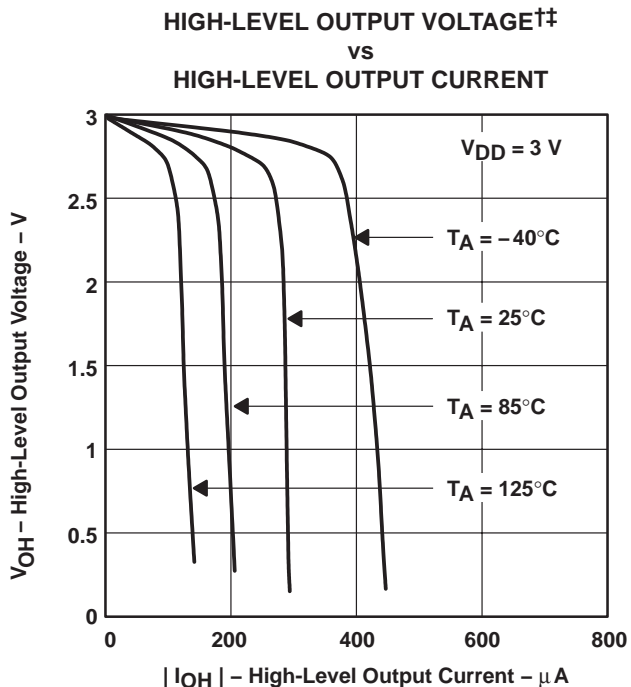

**Figure 15**

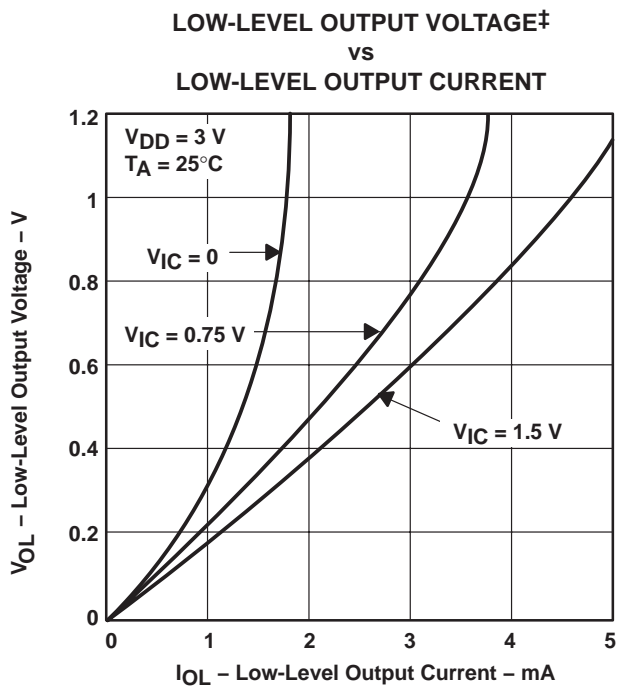

**Figure 16**

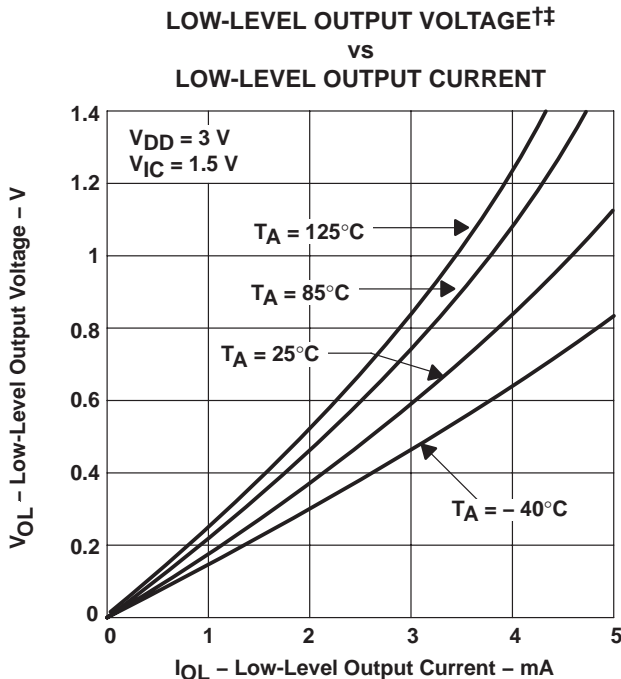

**Figure 17**

† Data at high and low temperatures are applicable only within the rated operating free-air temperature ranges of the various devices.  
 ‡ For all curves where  $V_{DD} = 5\text{ V}$ , all loads are referenced to 2.5 V. For all curves where  $V_{DD} = 3\text{ V}$ , all loads are referenced to 1.5 V.

**TYPICAL CHARACTERISTICS**

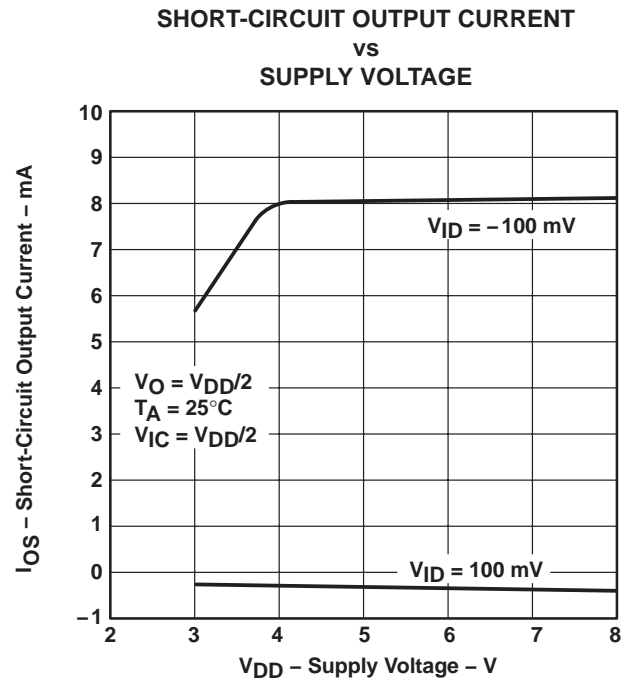
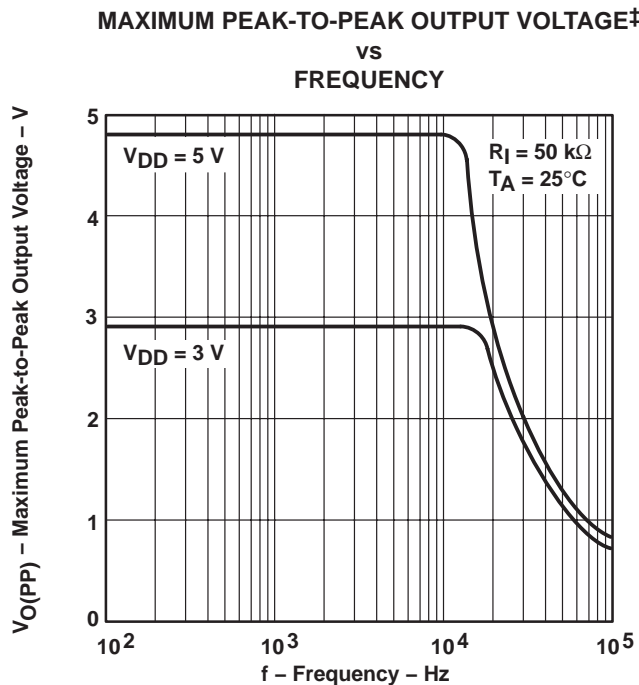
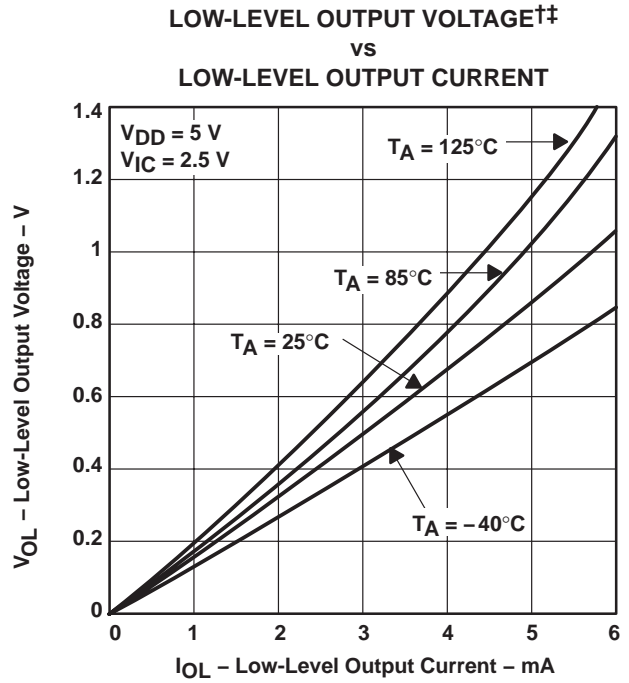
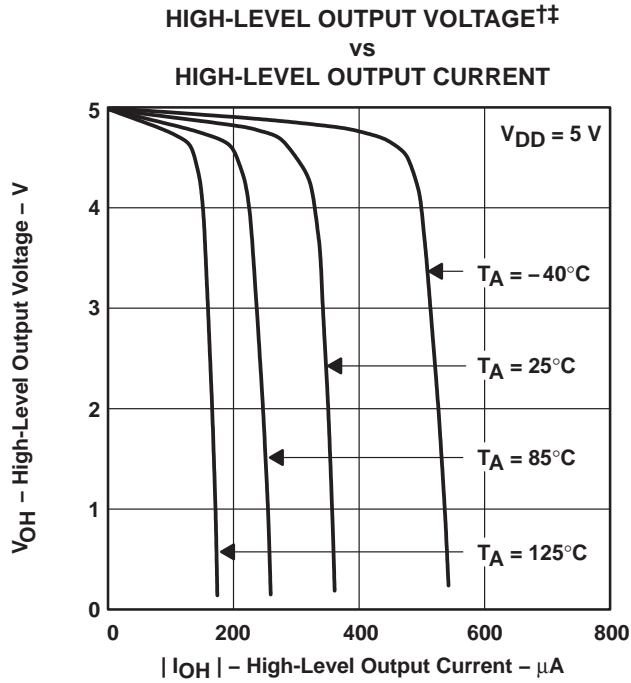

† Data at high and low temperatures are applicable only within the rated operating free-air temperature ranges of the various devices.  
 ‡ For all curves where  $V_{DD} = 5\text{ V}$ , all loads are referenced to 2.5 V. For all curves where  $V_{DD} = 3\text{ V}$ , all loads are referenced to 1.5 V.

**TLV225x, TLV225xA**  
**Advanced LinCMOS™ RAIL-TO-RAIL**  
**VERY LOW-POWER OPERATIONAL AMPLIFIERS**

SLOS185D – FEBRUARY 1997 – REVISED AUGUST 2006

**TYPICAL CHARACTERISTICS**

**SHORT-CIRCUIT OUTPUT CURRENT†**  
**vs**  
**FREE-AIR TEMPERATURE**

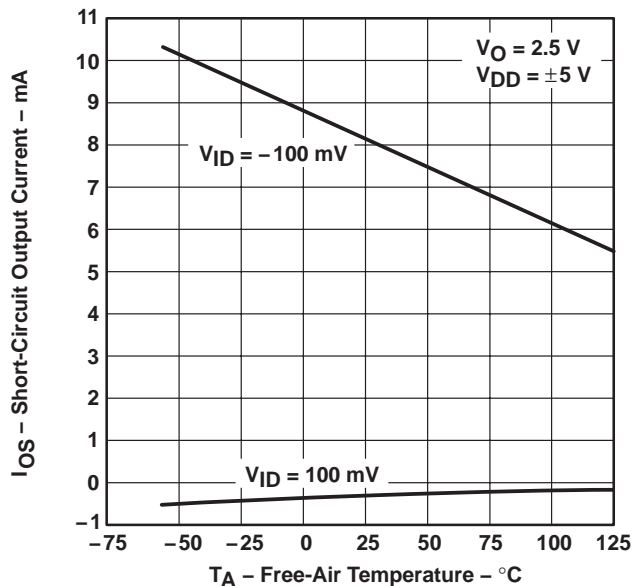

**Figure 22**

**DIFFERENTIAL INPUT VOLTAGE‡**  
**vs**  
**OUTPUT VOLTAGE**

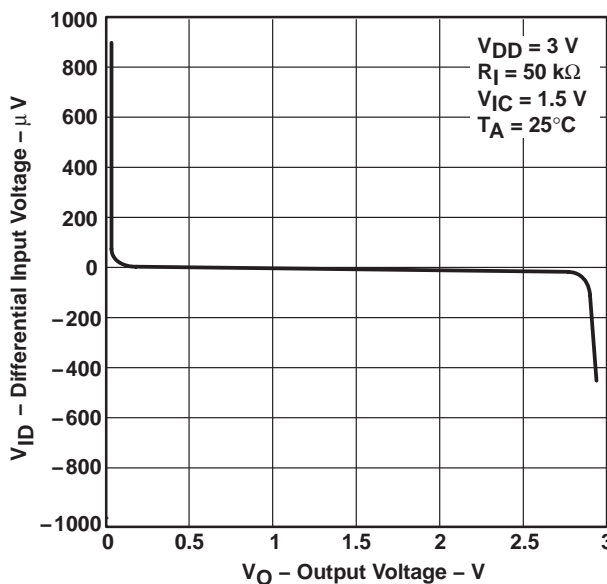

**Figure 23**

**DIFFERENTIAL INPUT VOLTAGE‡**  
**vs**  
**OUTPUT VOLTAGE**

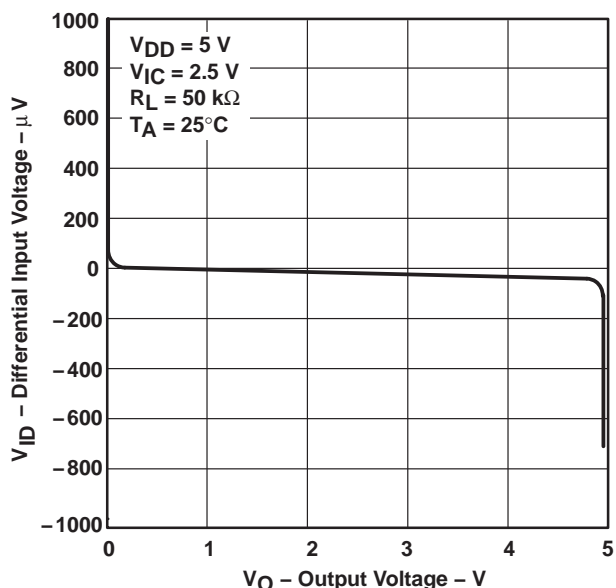

**Figure 24**

**DIFFERENTIAL VOLTAGE AMPLIFICATION†‡**  
**vs**  
**LOAD RESISTANCE**

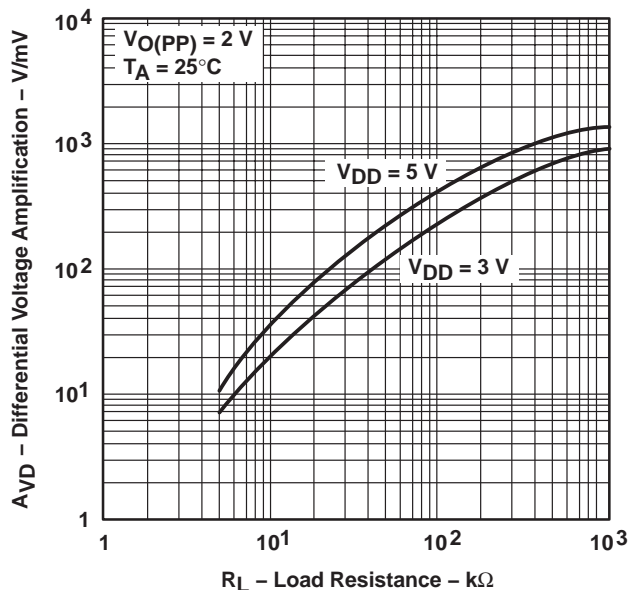

**Figure 25**

† Data at high and low temperatures are applicable only within the rated operating free-air temperature ranges of the various devices.

‡ For all curves where  $V_{DD} = 5\text{ V}$ , all loads are referenced to 2.5 V. For all curves where  $V_{DD} = 3\text{ V}$ , all loads are referenced to 1.5 V.



**TYPICAL CHARACTERISTICS**

**LARGE-SIGNAL DIFFERENTIAL VOLTAGE†  
 AMPLIFICATION AND PHASE MARGIN  
 vs  
 FREQUENCY**

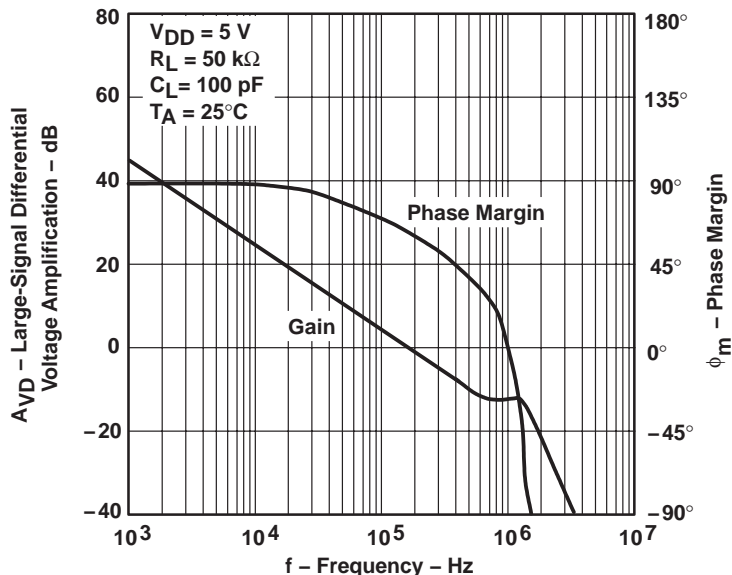

**Figure 26**

**LARGE-SIGNAL DIFFERENTIAL VOLTAGE†  
 AMPLIFICATION AND PHASE MARGIN  
 vs  
 FREQUENCY**

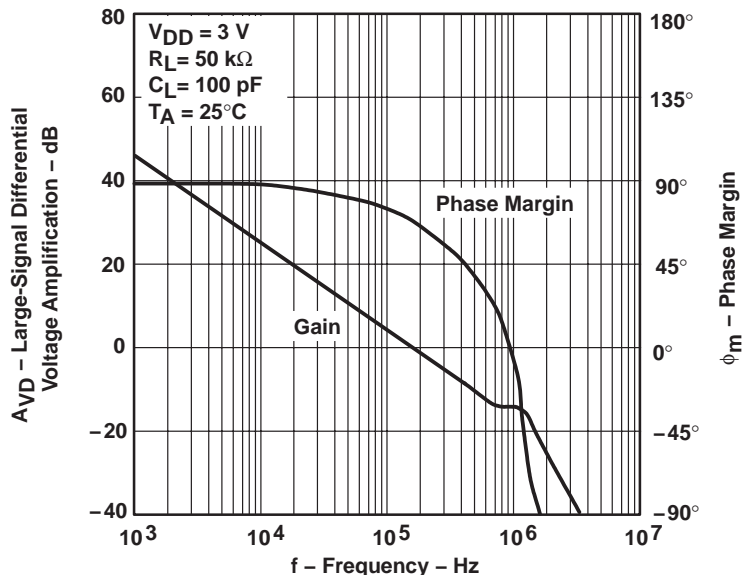

**Figure 27**

† For all curves where  $V_{DD} = 5\text{ V}$ , all loads are referenced to 2.5 V. For all curves where  $V_{DD} = 3\text{ V}$ , all loads are referenced to 1.5 V.

**TLV225x, TLV225xA**  
**Advanced LinCMOS™ RAIL-TO-RAIL**  
**VERY LOW-POWER OPERATIONAL AMPLIFIERS**

SLOS185D – FEBRUARY 1997 – REVISED AUGUST 2006

**TYPICAL CHARACTERISTICS**

**LARGE-SIGNAL DIFFERENTIAL††  
 VOLTAGE AMPLIFICATION**  
 vs  
**FREE-AIR TEMPERATURE**

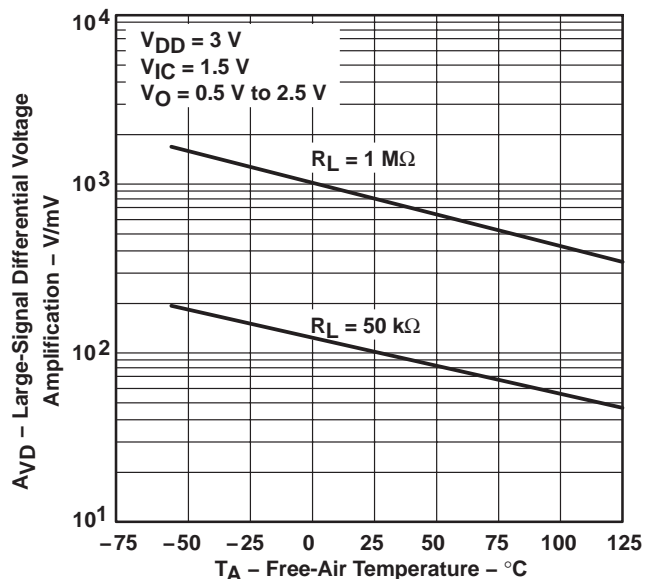

**Figure 28**

**LARGE-SIGNAL DIFFERENTIAL††  
 VOLTAGE AMPLIFICATION**  
 vs  
**FREE-AIR TEMPERATURE**

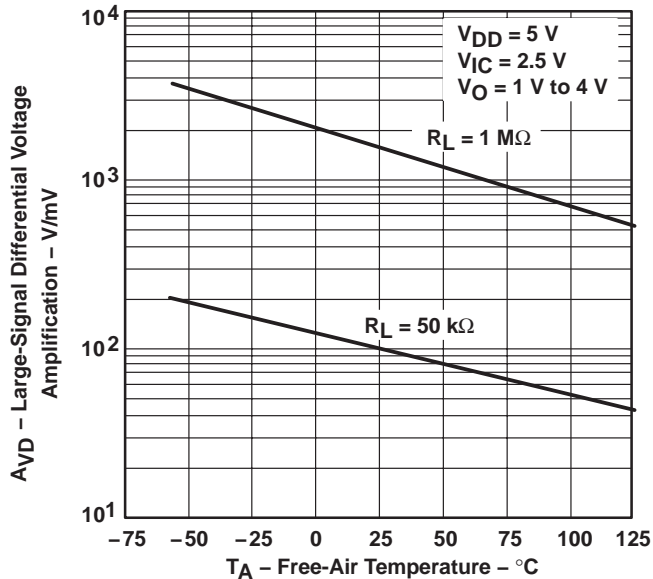

**Figure 29**

**OUTPUT IMPEDANCE†  
 vs  
 FREQUENCY**

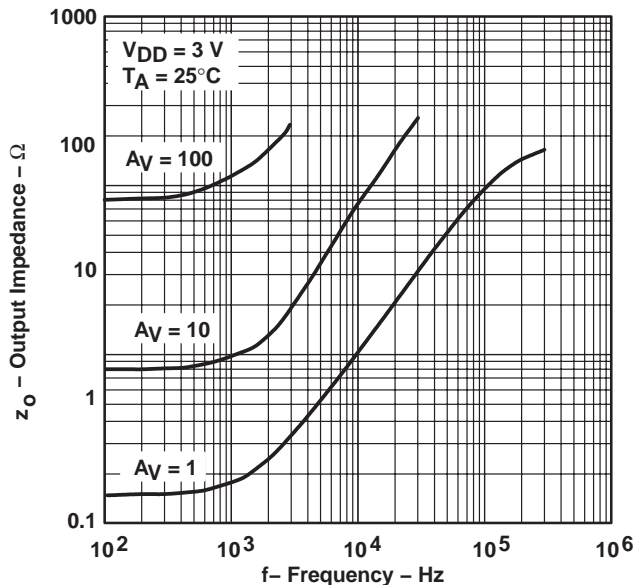

**Figure 30**

**OUTPUT IMPEDANCE†  
 vs  
 FREQUENCY**

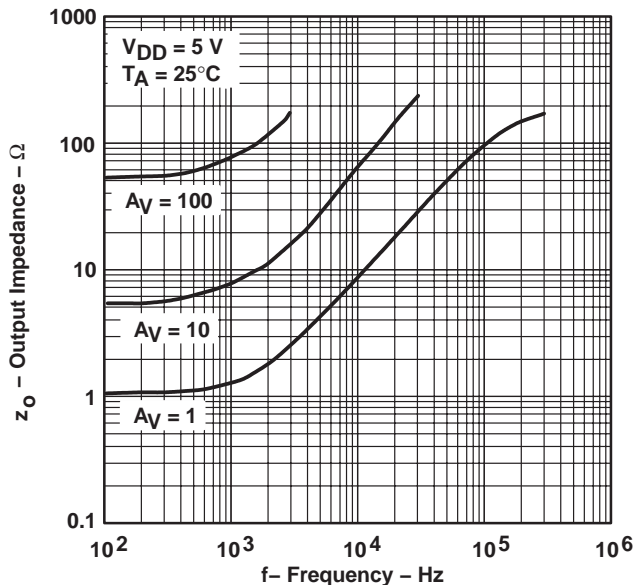

**Figure 31**

† Data at high and low temperatures are applicable only within the rated operating free-air temperature ranges of the various devices.  
 ‡ For all curves where  $V_{DD} = 5\text{ V}$ , all loads are referenced to 2.5 V. For all curves where  $V_{DD} = 3\text{ V}$ , all loads are referenced to 1.5 V.

**TYPICAL CHARACTERISTICS**

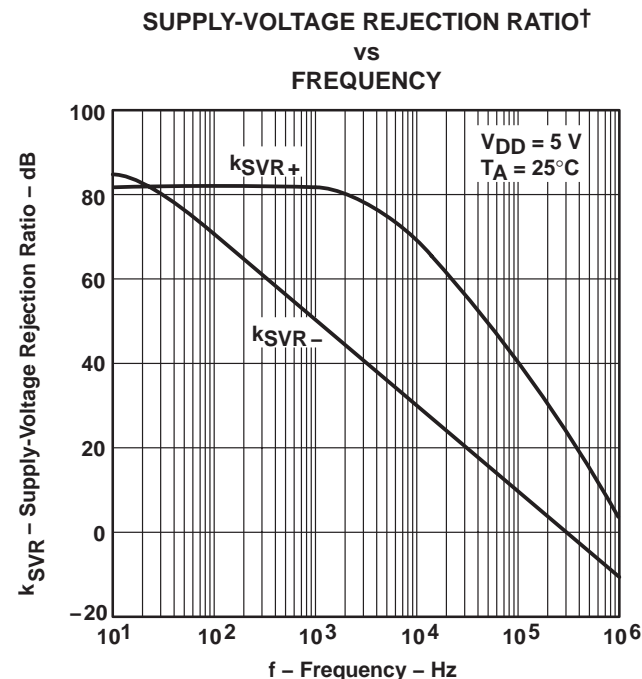
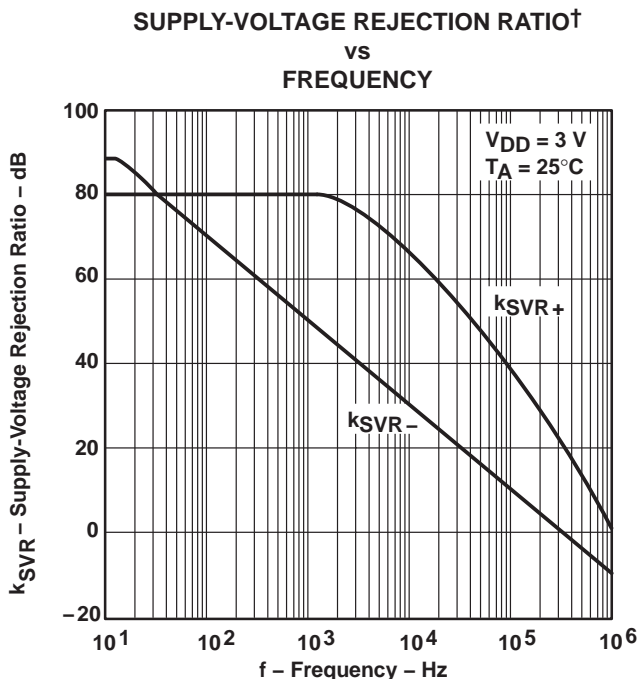
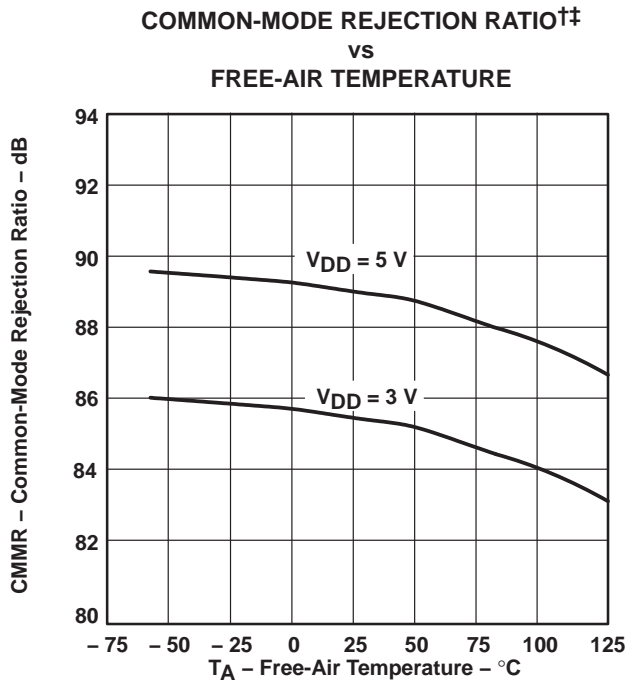
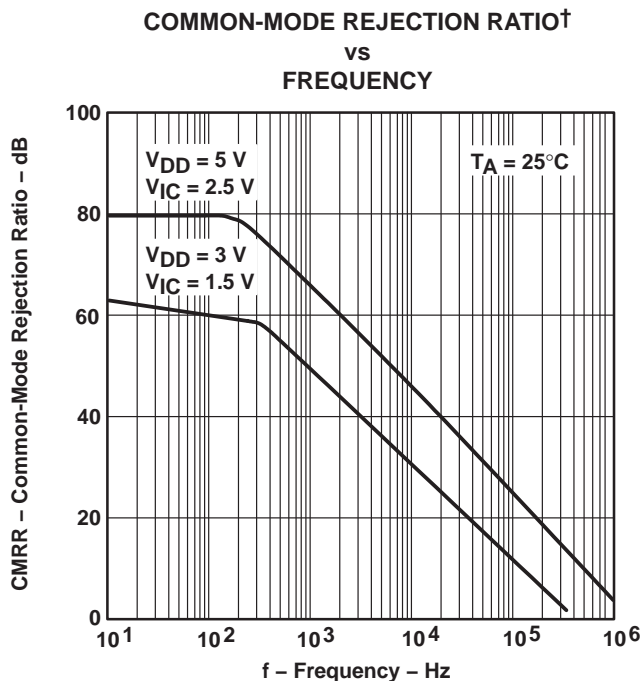

† For all curves where  $V_{DD} = 5\text{ V}$ , all loads are referenced to 2.5 V. For all curves where  $V_{DD} = 3\text{ V}$ , all loads are referenced to 1.5 V.  
 †† Data at high and low temperatures are applicable only within the rated operating free-air temperature ranges of the various devices.

**TYPICAL CHARACTERISTICS**

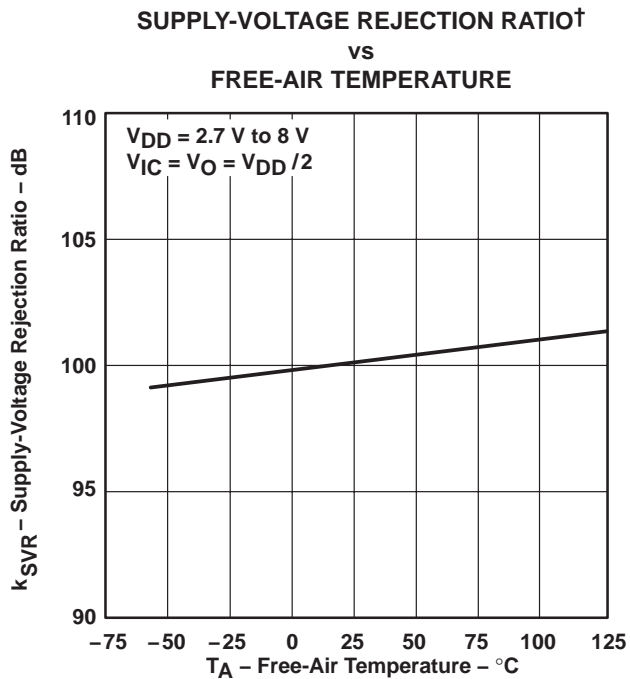

**Figure 36**

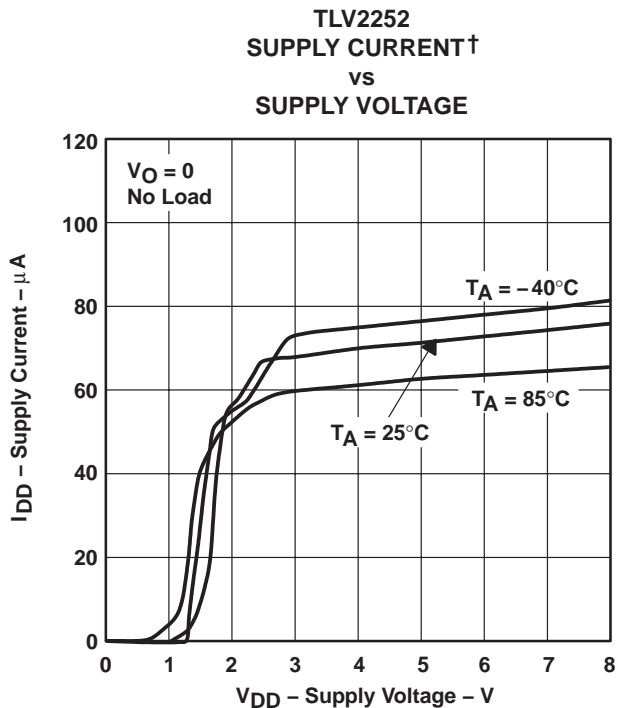

**Figure 37**

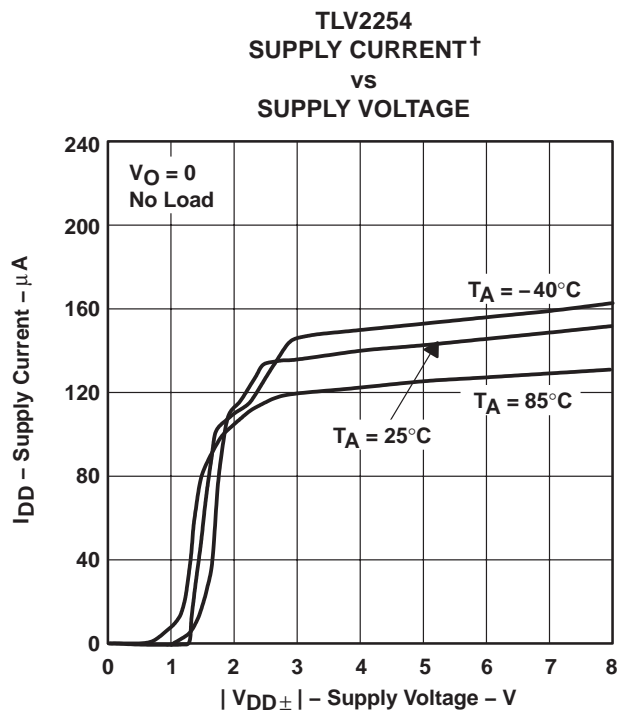

**Figure 38**

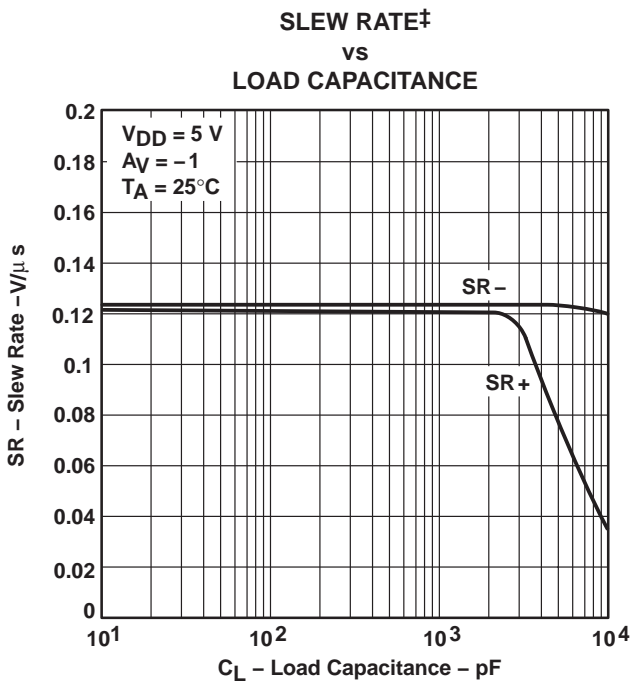

**Figure 39**

† Data at high and low temperatures are applicable only within the rated operating free-air temperature ranges of the various devices.  
 ‡ For all curves where  $V_{DD} = 5 \text{ V}$ , all loads are referenced to 2.5 V. For all curves where  $V_{DD} = 3 \text{ V}$ , all loads are referenced to 1.5 V.

**TYPICAL CHARACTERISTICS**

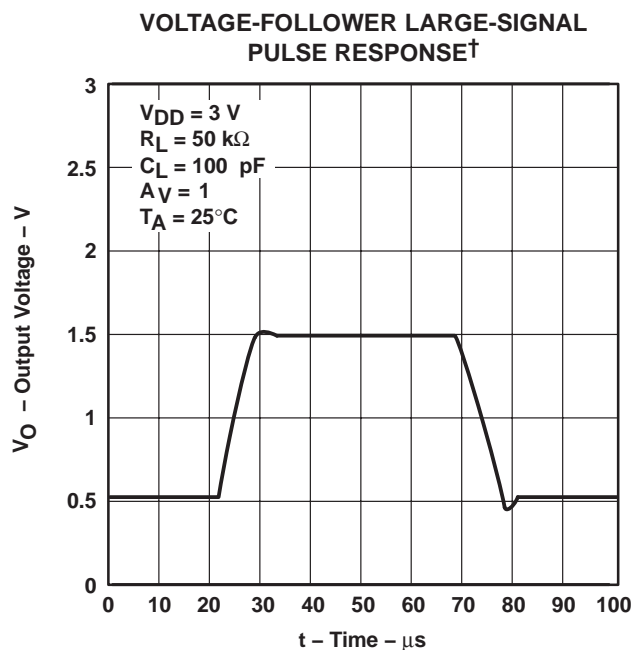
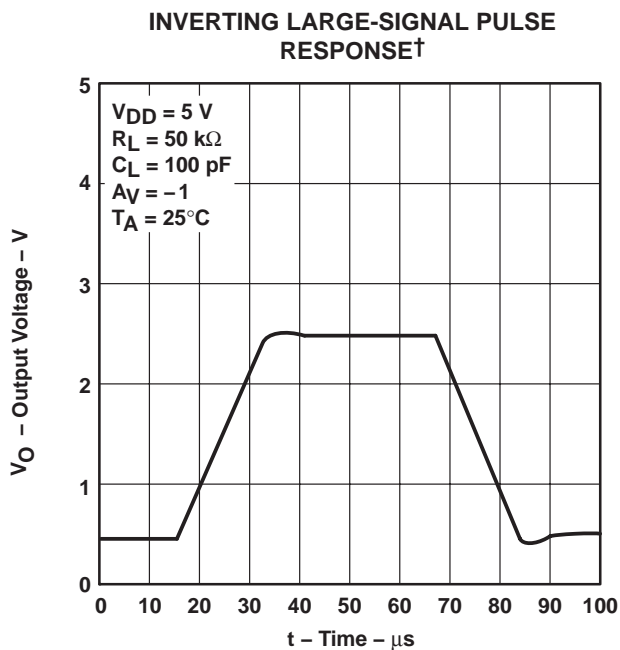
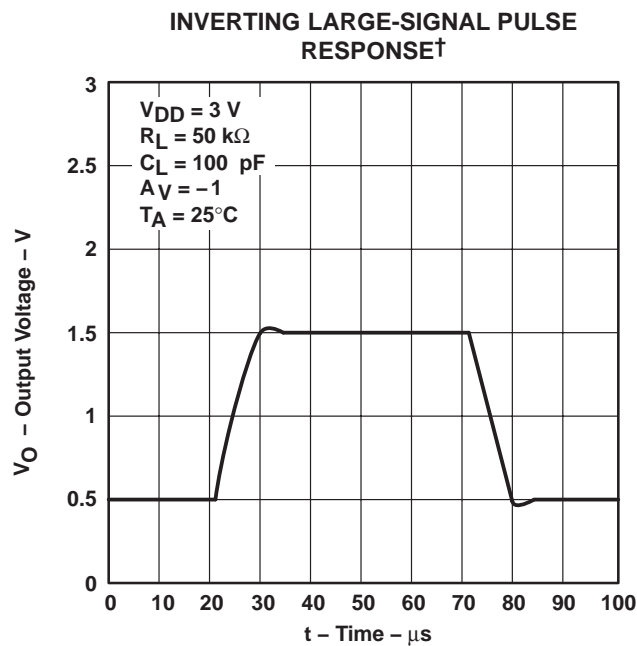
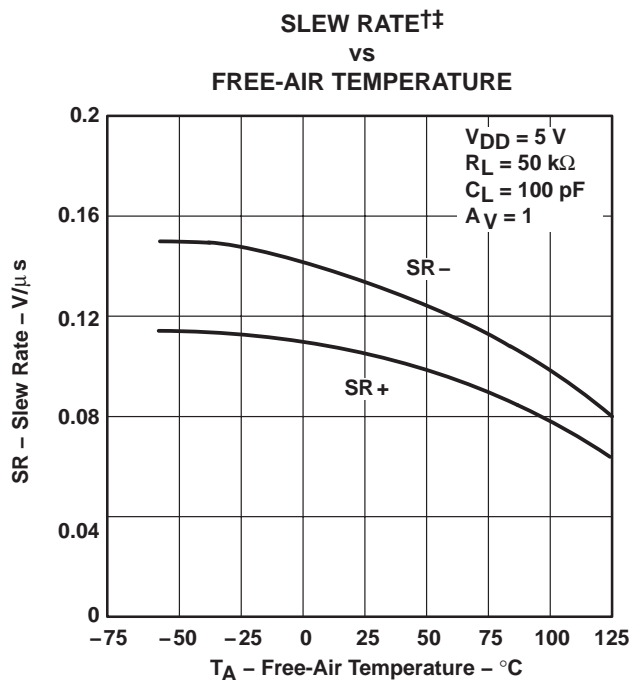

† Data at high and low temperatures are applicable only within the rated operating free-air temperature ranges of the various devices.  
 ‡ For all curves where  $V_{DD} = 5\text{ V}$ , all loads are referenced to 2.5 V. For all curves where  $V_{DD} = 3\text{ V}$ , all loads are referenced to 1.5 V.

**TYPICAL CHARACTERISTICS**

**VOLTAGE-FOLLOWER LARGE-SIGNAL PULSE RESPONSE†**

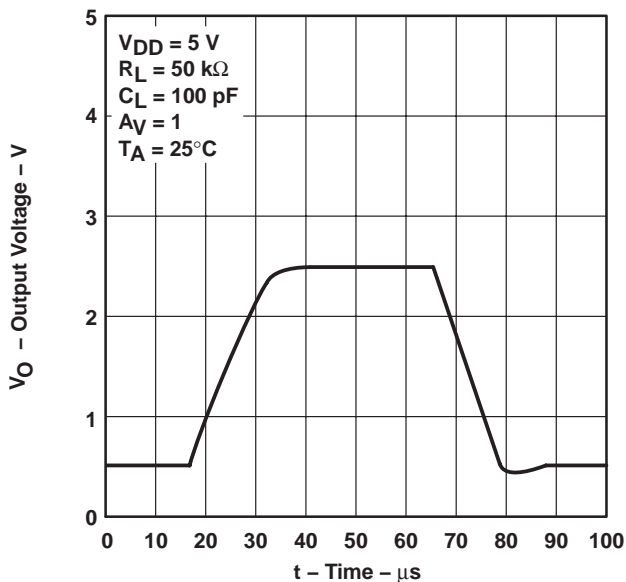

**Figure 44**

**INVERTING SMALL-SIGNAL PULSE RESPONSE†**

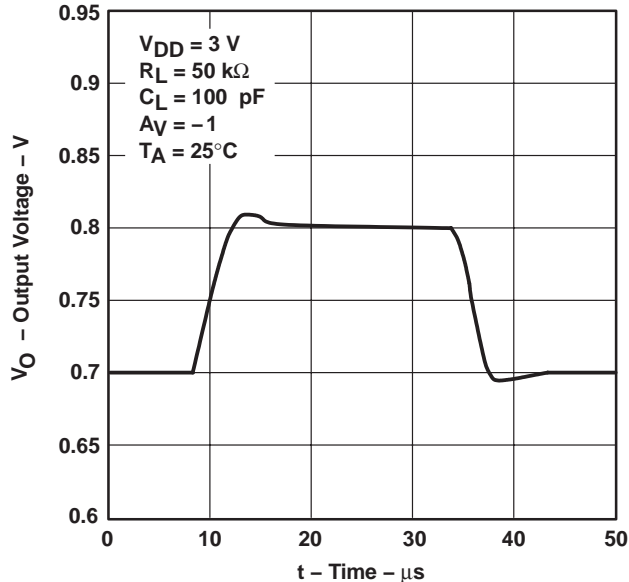

**Figure 45**

**INVERTING SMALL-SIGNAL PULSE RESPONSE†**

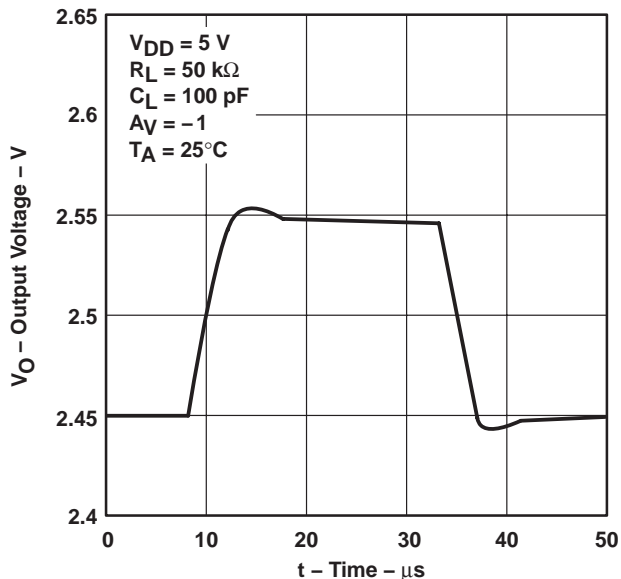

**Figure 46**

**VOLTAGE-FOLLOWER SMALL-SIGNAL PULSE RESPONSE†**

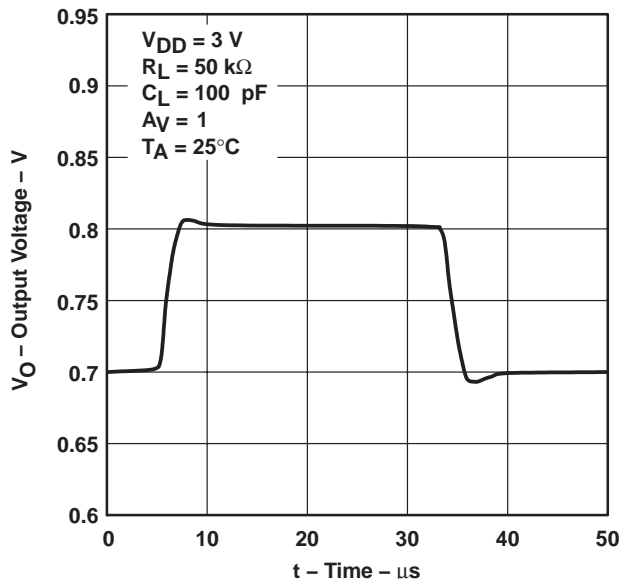

**Figure 47**

† For all curves where  $V_{DD} = 5\text{ V}$ , all loads are referenced to 2.5 V. For all curves where  $V_{DD} = 3\text{ V}$ , all loads are referenced to 1.5 V.

**TYPICAL CHARACTERISTICS**

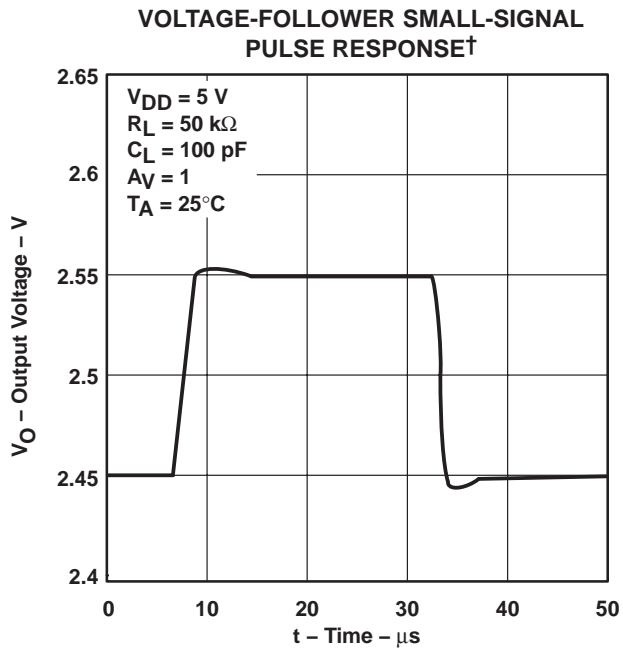

**Figure 48**

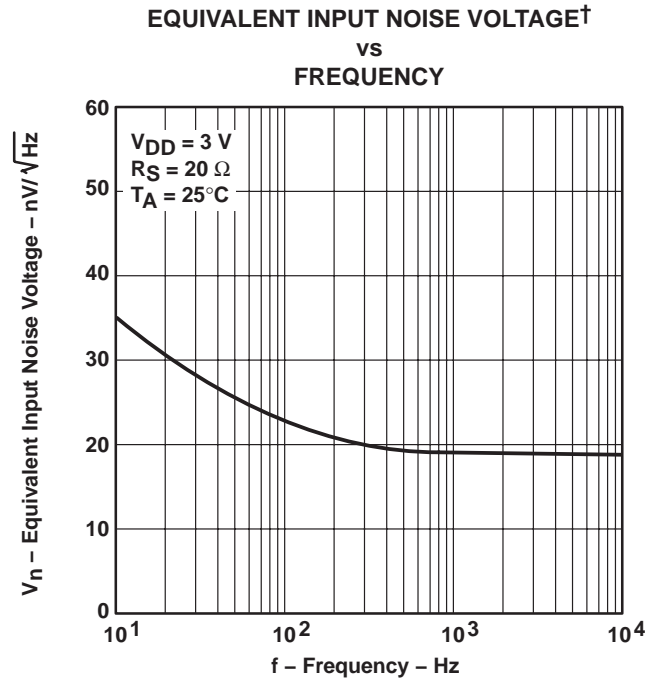

**Figure 49**

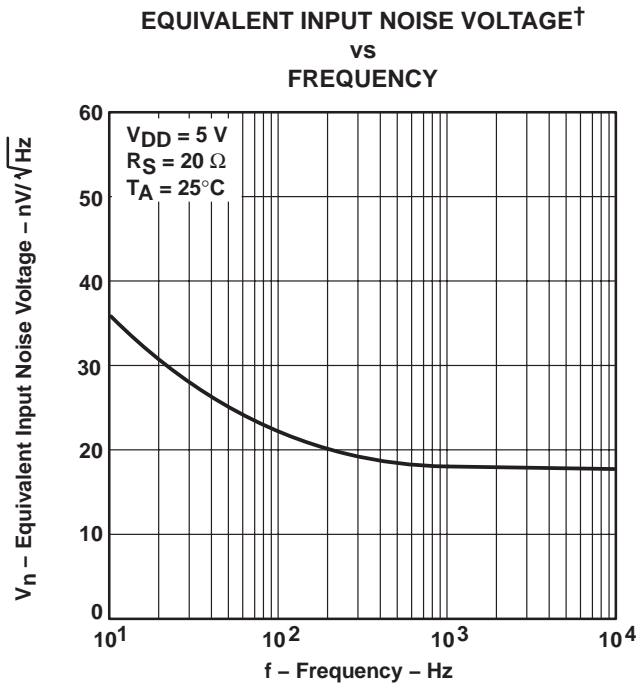

**Figure 50**

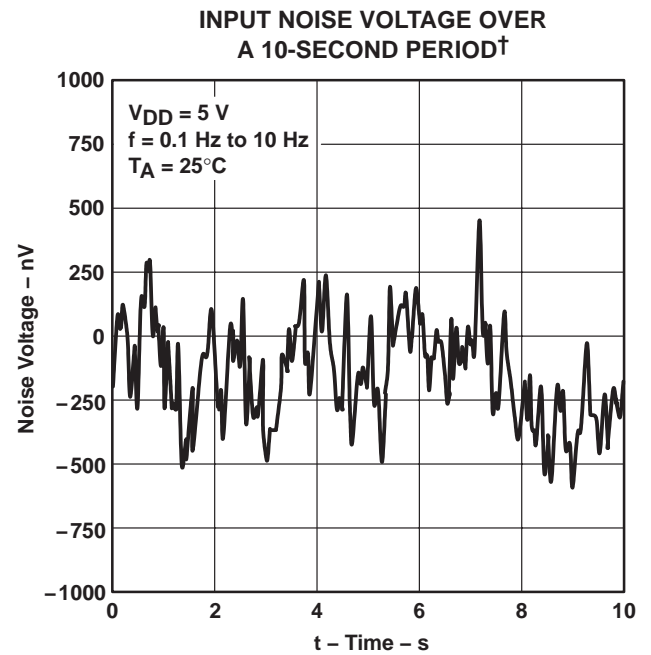
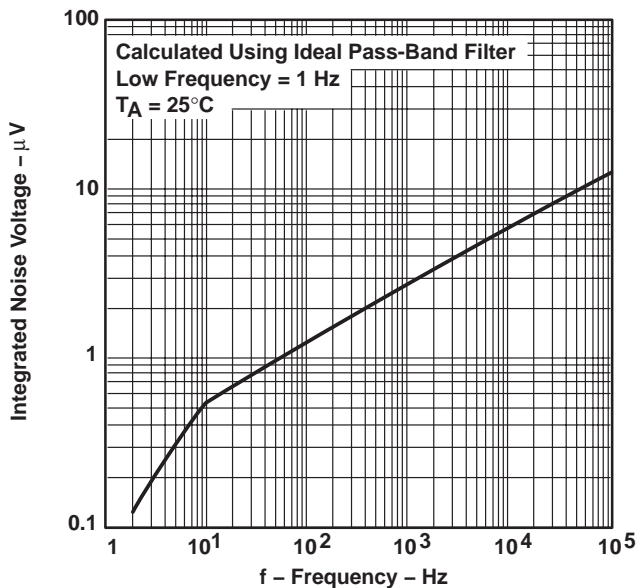

**Figure 51**

† For all curves where  $V_{DD} = 5\text{ V}$ , all loads are referenced to 2.5 V. For all curves where  $V_{DD} = 3\text{ V}$ , all loads are referenced to 1.5 V.

**TYPICAL CHARACTERISTICS**

**INTEGRATED NOISE VOLTAGE†**  
**vs**  
**FREQUENCY**



**Figure 52**

**TOTAL HARMONIC DISTORTION PLUS NOISE†**  
**vs**  
**FREQUENCY**

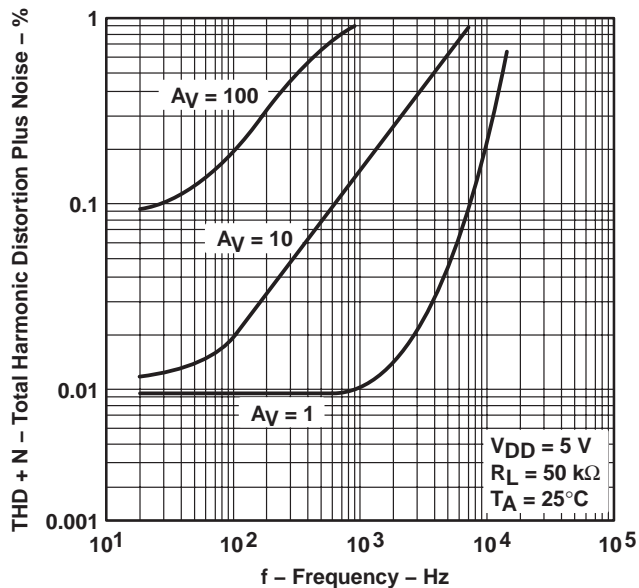

**Figure 53**

**GAIN-BANDWIDTH PRODUCT**  
**vs**  
**SUPPLY VOLTAGE**

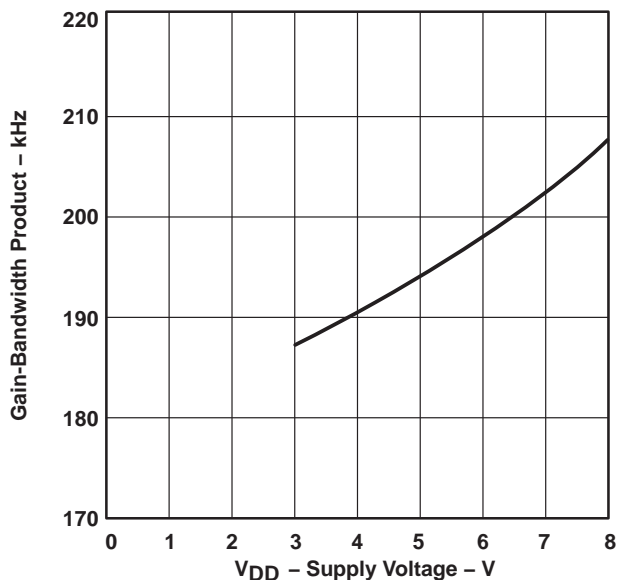

**Figure 54**

**GAIN-BANDWIDTH PRODUCT†‡**  
**vs**  
**FREE-AIR TEMPERATURE**

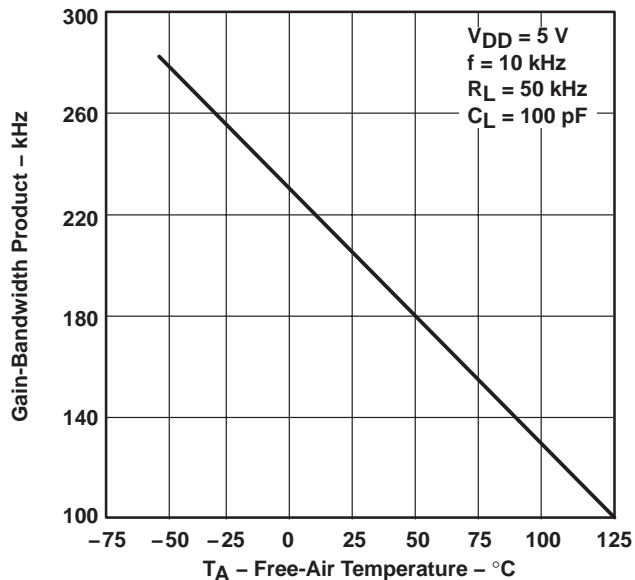

**Figure 55**

† For all curves where  $V_{DD} = 5\text{ V}$ , all loads are referenced to 2.5 V. For all curves where  $V_{DD} = 3\text{ V}$ , all loads are referenced to 1.5 V.

**TYPICAL CHARACTERISTICS**

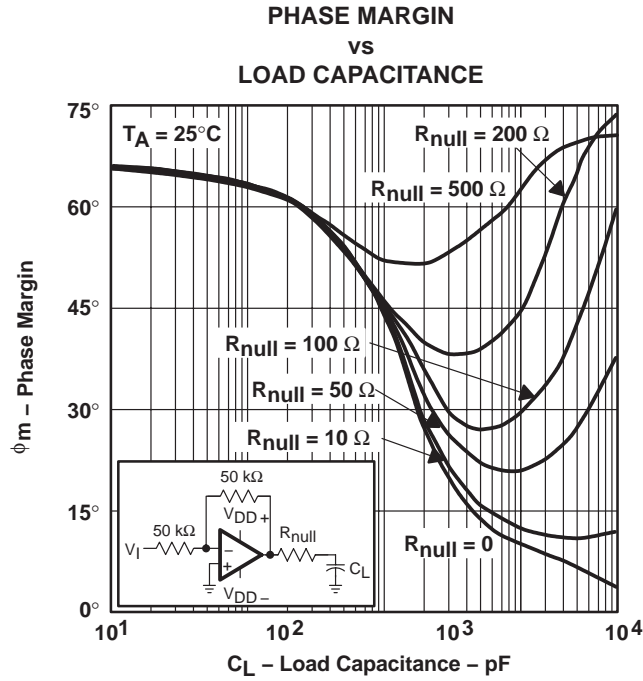

**Figure 56**

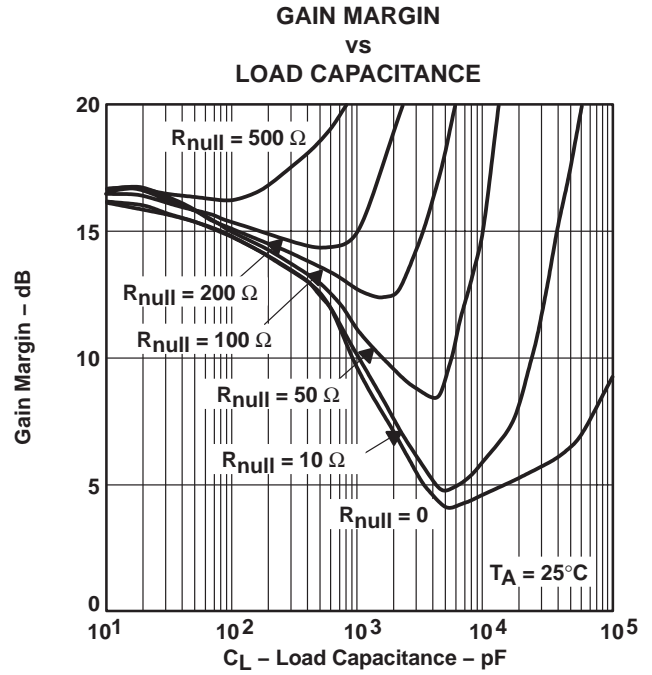

**Figure 57**

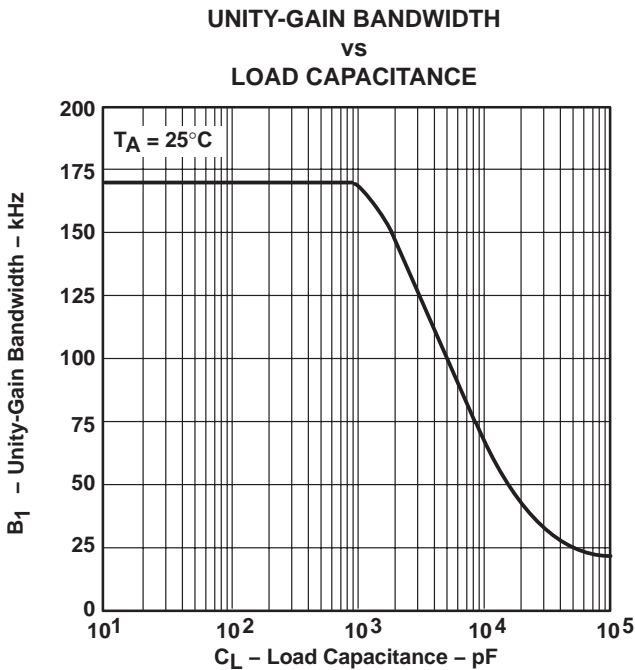

**Figure 58**

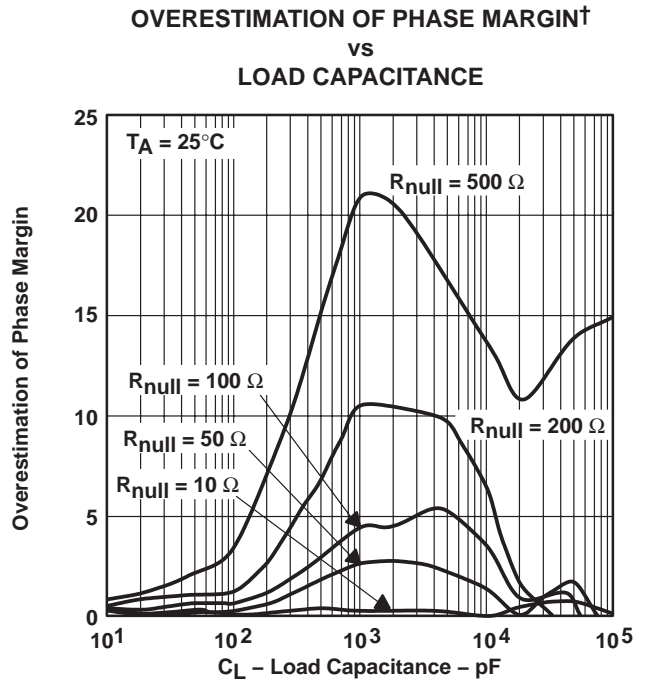

† See application information

**Figure 59**

† For all curves where  $V_{DD} = 5\ \text{V}$ , all loads are referenced to 2.5 V. For all curves where  $V_{DD} = 3\ \text{V}$ , all loads are referenced to 1.5 V.  
 ‡ Data at high and low temperatures are applicable only within the rated operating free-air temperature ranges of the various devices.

**APPLICATION INFORMATION**

**driving large capacitive loads**

The TLV2252 is designed to drive larger capacitive loads than most CMOS operational amplifiers. Figure 56 and Figure 57 illustrate its ability to drive loads up to 1000 pF while maintaining good gain and phase margins ( $R_{null} = 0$ ).

A smaller series resistor ( $R_{null}$ ) at the output of the device (see Figure 60) improves the gain and phase margins when driving large capacitive loads. Figure 55 and Figure 56 show the effects of adding series resistances of 10  $\Omega$ , 50  $\Omega$ , 100  $\Omega$ , 200  $\Omega$ , and 500  $\Omega$ . The addition of this series resistor has two effects: the first adds a zero to the transfer function and the second reduces the frequency of the pole associated with the output load in the transfer function.

The zero introduced to the transfer function is equal to the series resistance times the load capacitance. To calculate the improvement in phase margin, equation 1 can be used.

$$\Delta\phi_{m1} = \tan^{-1} \left( 2 \times \pi \times \text{UGBW} \times R_{null} \times C_L \right) \tag{1}$$

Where :

- $\Delta\phi_{m1}$  = improvement in phase margin
- UGBW = unity-gain bandwidth frequency
- $R_{null}$  = output series resistance
- $C_L$  = load capacitance

The unity-gain bandwidth (UGBW) frequency decreases as the capacitive load increases (see Figure 58). To use equation 1, UGBW must be approximated from Figure 58.

Using equation 1 alone overestimates the improvement in phase margin as illustrated in Figure 59. The overestimation is caused by the decrease in the frequency of the pole associated with the load, providing additional phase shift and reducing the overall improvement in phase margin.

Using Figure 60, with equation 1 enables the designer to choose the appropriate output series resistance to optimize the design of circuits driving large capacitance loads.

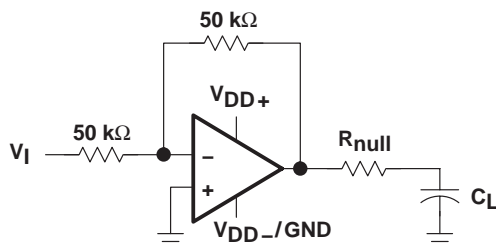

**Figure 60. Series-Resistance Circuit**

## APPLICATION INFORMATION

### macromodel information

Macromodel information provided was derived using Microsim *Parts™*, the model generation software used with Microsim *PSpice™*. The Boyle macromodel (see Note 5) and subcircuit in Figure 61 are generated using the TLV2252 typical electrical and operating characteristics at  $T_A = 25^\circ\text{C}$ . Using this information, output simulations of the following key parameters can be generated to a tolerance of 20% (in most cases):

- Maximum positive output voltage swing
- Maximum negative output voltage swing
- Slew rate
- Quiescent power dissipation
- Input bias current
- Open-loop voltage amplification
- Unity-gain frequency
- Common-mode rejection ratio
- Phase margin
- DC output resistance
- AC output resistance
- Short-circuit output current limit

NOTE 5: G. R. Boyle, B. M. Cohn, D. O. Pederson, and J. E. Solomon, "Macromodeling of Integrated Circuit Operational Amplifiers," *IEEE Journal of Solid-State Circuits*, SC-9, 353 (1974).

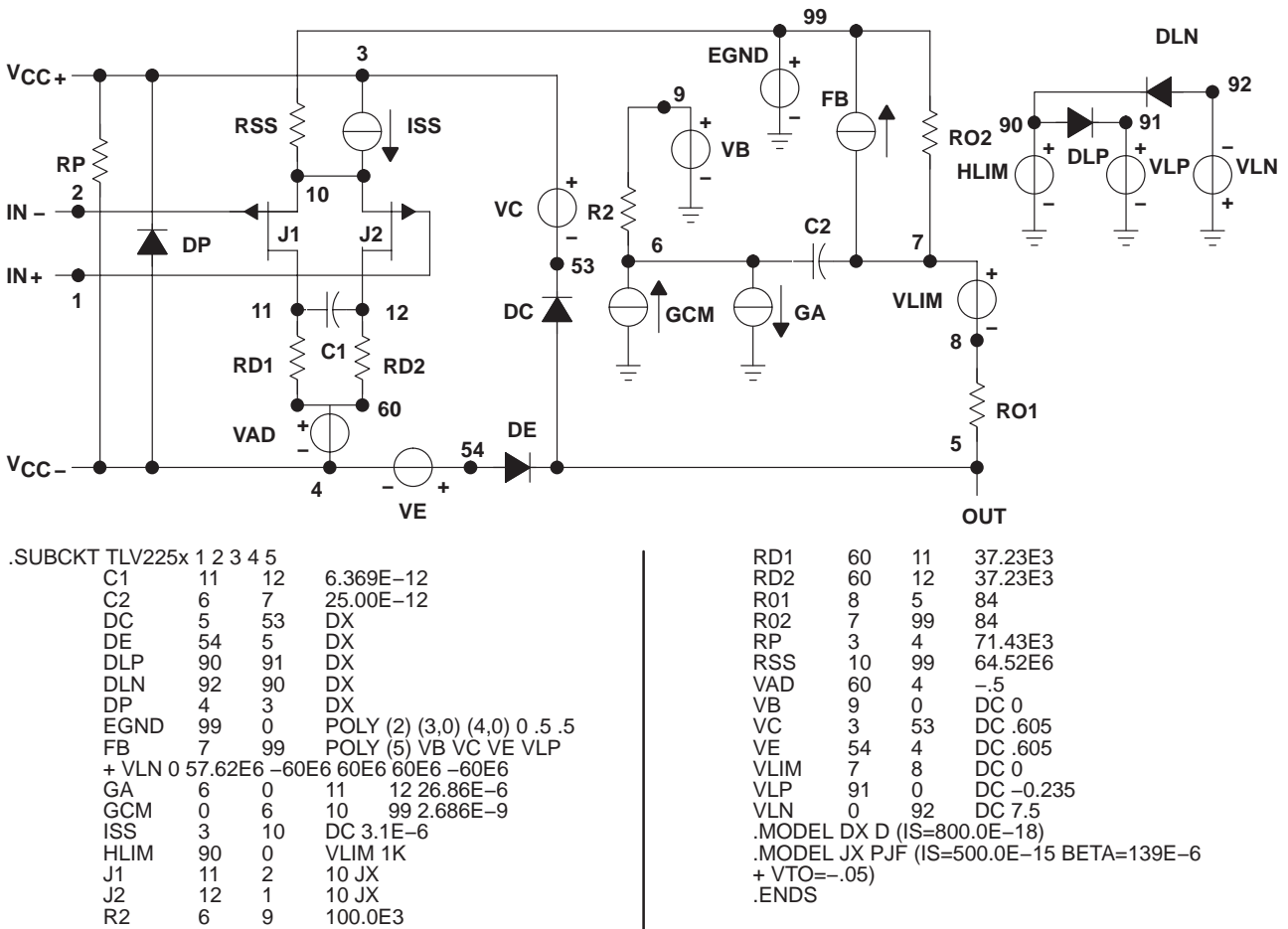

**Figure 61. Boyle Macromodel and Subcircuit**

*PSpice* and *Parts* are trademarks of MicroSim Corporation.

**PACKAGING INFORMATION**

Orderable Device	Status (1)	Package Type	Package Drawing	Pins	Package Qty	Eco Plan (2)	Lead/Ball Finish (6)	MSL Peak Temp (3)	Op Temp (°C)	Device Marking (4/5)	Samples
5962-9550401QPA	ACTIVE	CDIP	JG	8	1	TBD	A42	N / A for Pkg Type	-55 to 125	9550401QPA TLV2262M	<a href="#">Samples</a>
5962-9550403QHA	ACTIVE	CFP	U	10	1	TBD	A42	N / A for Pkg Type	-55 to 125	9550403QHA TLV2262AM	<a href="#">Samples</a>
5962-9550403QPA	ACTIVE	CDIP	JG	8	1	TBD	A42	N / A for Pkg Type	-55 to 125	9550403QPA TLV2262AM	<a href="#">Samples</a>
5962-9566601QPA	ACTIVE	CDIP	JG	8	1	TBD	A42	N / A for Pkg Type	-55 to 125	9566601QPA TLV2252M	<a href="#">Samples</a>
5962-9566603QPA	ACTIVE	CDIP	JG	8	1	TBD	A42	N / A for Pkg Type	-55 to 125	9566603QPA TLV2252AM	<a href="#">Samples</a>
TLV2252AID	ACTIVE	SOIC	D	8	75	Green (RoHS & no Sb/Br)	CU NIPDAU	Level-1-260C-UNLIM	-40 to 125	V2252A	<a href="#">Samples</a>
TLV2252AIDG4	ACTIVE	SOIC	D	8	75	Green (RoHS & no Sb/Br)	CU NIPDAU	Level-1-260C-UNLIM	-40 to 125	V2252A	<a href="#">Samples</a>
TLV2252AIDR	ACTIVE	SOIC	D	8	2500	Green (RoHS & no Sb/Br)	CU NIPDAU	Level-1-260C-UNLIM	-40 to 125	V2252A	<a href="#">Samples</a>
TLV2252AIDRG4	ACTIVE	SOIC	D	8	2500	Green (RoHS & no Sb/Br)	CU NIPDAU	Level-1-260C-UNLIM	-40 to 125	V2252A	<a href="#">Samples</a>
TLV2252AIP	ACTIVE	PDIP	P	8	50	Pb-Free (RoHS)	CU NIPDAU	N / A for Pkg Type	-40 to 125	TLV2252AI	<a href="#">Samples</a>
TLV2252AIPW	ACTIVE	TSSOP	PW	8	150	Green (RoHS & no Sb/Br)	CU NIPDAU	Level-1-260C-UNLIM	-40 to 125	TY252A	<a href="#">Samples</a>
TLV2252AIPWG4	ACTIVE	TSSOP	PW	8	150	Green (RoHS & no Sb/Br)	CU NIPDAU	Level-1-260C-UNLIM	-40 to 125	TY252A	<a href="#">Samples</a>
TLV2252AIPWLE	OBSOLETE	TSSOP	PW	8		TBD	Call TI	Call TI	-40 to 125		
TLV2252AIPWR	ACTIVE	TSSOP	PW	8	2000	Green (RoHS & no Sb/Br)	CU NIPDAU	Level-1-260C-UNLIM	-40 to 125	TY252A	<a href="#">Samples</a>
TLV2252AIPWRG4	ACTIVE	TSSOP	PW	8	2000	Green (RoHS & no Sb/Br)	CU NIPDAU	Level-1-260C-UNLIM	-40 to 125	TY252A	<a href="#">Samples</a>
TLV2252AMJGB	ACTIVE	CDIP	JG	8	1	TBD	A42	N / A for Pkg Type	-55 to 125	9566603QPA TLV2252AM	<a href="#">Samples</a>
TLV2252AQDRG4	ACTIVE	SOIC	D	8	2500	Green (RoHS & no Sb/Br)	CU NIPDAU	Level-1-260C-UNLIM		V2252A	<a href="#">Samples</a>

Orderable Device	Status (1)	Package Type	Package Drawing	Pins	Package Qty	Eco Plan (2)	Lead/Ball Finish (6)	MSL Peak Temp (3)	Op Temp (°C)	Device Marking (4/5)	Samples
TLV2252CP	ACTIVE	PDIP	P	8		TBD	Call TI	Call TI	0 to 70		<a href="#">Samples</a>
TLV2252ID	ACTIVE	SOIC	D	8	75	Green (RoHS & no Sb/Br)	CU NIPDAU	Level-1-260C-UNLIM	-40 to 125	V2252I	<a href="#">Samples</a>
TLV2252IDG4	ACTIVE	SOIC	D	8	75	Green (RoHS & no Sb/Br)	CU NIPDAU	Level-1-260C-UNLIM	-40 to 125	V2252I	<a href="#">Samples</a>
TLV2252IDR	ACTIVE	SOIC	D	8	2500	Green (RoHS & no Sb/Br)	CU NIPDAU	Level-1-260C-UNLIM	-40 to 125	V2252I	<a href="#">Samples</a>
TLV2252IDRG4	ACTIVE	SOIC	D	8	2500	Green (RoHS & no Sb/Br)	CU NIPDAU	Level-1-260C-UNLIM	-40 to 125	V2252I	<a href="#">Samples</a>
TLV2252IP	ACTIVE	PDIP	P	8	50	Pb-Free (RoHS)	CU NIPDAU	N / A for Pkg Type	-40 to 125	TLV2252IP	<a href="#">Samples</a>
TLV2252MJGB	ACTIVE	CDIP	JG	8	1	TBD	A42	N / A for Pkg Type	-55 to 125	9566601QPA TLV2252M	<a href="#">Samples</a>
TLV2252QD	OBSOLETE	SOIC	D	8		TBD	Call TI	Call TI	-40 to 125		
TLV2252QDR	OBSOLETE	SOIC	D	8		TBD	Call TI	Call TI	-40 to 125		
TLV2254AID	ACTIVE	SOIC	D	14	50	Green (RoHS & no Sb/Br)	CU NIPDAU	Level-1-260C-UNLIM	-40 to 125	V2254AI	<a href="#">Samples</a>
TLV2254AIDG4	ACTIVE	SOIC	D	14	50	Green (RoHS & no Sb/Br)	CU NIPDAU	Level-1-260C-UNLIM	-40 to 125	V2254AI	<a href="#">Samples</a>
TLV2254AIDR	ACTIVE	SOIC	D	14	2500	Green (RoHS & no Sb/Br)	CU NIPDAU	Level-1-260C-UNLIM	-40 to 125	V2254AI	<a href="#">Samples</a>
TLV2254AIDRG4	ACTIVE	SOIC	D	14	2500	Green (RoHS & no Sb/Br)	CU NIPDAU	Level-1-260C-UNLIM	-40 to 125	V2254AI	<a href="#">Samples</a>
TLV2254AIN	ACTIVE	PDIP	N	14	25	Pb-Free (RoHS)	CU NIPDAU	N / A for Pkg Type	-40 to 125	TLV2254AIN	<a href="#">Samples</a>
TLV2254AIPW	ACTIVE	TSSOP	PW	14	90	Green (RoHS & no Sb/Br)	CU NIPDAU	Level-1-260C-UNLIM	-40 to 125	TY2254A	<a href="#">Samples</a>
TLV2254AIPWG4	ACTIVE	TSSOP	PW	14	90	Green (RoHS & no Sb/Br)	CU NIPDAU	Level-1-260C-UNLIM	-40 to 125	TY2254A	<a href="#">Samples</a>
TLV2254AIPWLE	OBSOLETE	TSSOP	PW	14		TBD	Call TI	Call TI	-40 to 125		
TLV2254AIPWR	ACTIVE	TSSOP	PW	14	2000	Green (RoHS & no Sb/Br)	CU NIPDAU	Level-1-260C-UNLIM	-40 to 125	TY2254A	<a href="#">Samples</a>
TLV2254AIPWRG4	ACTIVE	TSSOP	PW	14	2000	Green (RoHS & no Sb/Br)	CU NIPDAU	Level-1-260C-UNLIM	-40 to 125	TY2254A	<a href="#">Samples</a>

Orderable Device	Status (1)	Package Type	Package Drawing	Pins	Package Qty	Eco Plan (2)	Lead/Ball Finish (6)	MSL Peak Temp (3)	Op Temp (°C)	Device Marking (4/5)	Samples
TLV2254AQD	ACTIVE	SOIC	D	14	50	Green (RoHS & no Sb/Br)	CU NIPDAU	Level-1-260C-UNLIM	-40 to 125	TLV2254A	<a href="#">Samples</a>
TLV2254AQDR	OBSOLETE	SOIC	D	14		TBD	Call TI	Call TI	-40 to 125		
TLV2254ID	ACTIVE	SOIC	D	14	50	Green (RoHS & no Sb/Br)	CU NIPDAU	Level-1-260C-UNLIM	-40 to 125	TLV2254I	<a href="#">Samples</a>
TLV2254IDG4	ACTIVE	SOIC	D	14	50	Green (RoHS & no Sb/Br)	CU NIPDAU	Level-1-260C-UNLIM	-40 to 125	TLV2254I	<a href="#">Samples</a>
TLV2254IDR	ACTIVE	SOIC	D	14	2500	Green (RoHS & no Sb/Br)	CU NIPDAU	Level-1-260C-UNLIM	-40 to 125	TLV2254I	<a href="#">Samples</a>
TLV2254IDRG4	ACTIVE	SOIC	D	14	2500	Green (RoHS & no Sb/Br)	CU NIPDAU	Level-1-260C-UNLIM	-40 to 125	TLV2254I	<a href="#">Samples</a>
TLV2254IN	ACTIVE	PDIP	N	14	25	Pb-Free (RoHS)	CU NIPDAU	N / A for Pkg Type	-40 to 125	TLV2254IN	<a href="#">Samples</a>
TLV2262AMJGB	ACTIVE	CDIP	JG	8	1	TBD	A42	N / A for Pkg Type	-55 to 125	9550403QPA TLV2262AM	<a href="#">Samples</a>
TLV2262AMUB	ACTIVE	CFP	U	10	1	TBD	A42	N / A for Pkg Type	-55 to 125	9550403QHA TLV2262AM	<a href="#">Samples</a>
TLV2262MJGB	ACTIVE	CDIP	JG	8	1	TBD	A42	N / A for Pkg Type	-55 to 125	9550401QPA TLV2262M	<a href="#">Samples</a>

(1) The marketing status values are defined as follows:

**ACTIVE:** Product device recommended for new designs.

**LIFEBUY:** TI has announced that the device will be discontinued, and a lifetime-buy period is in effect.

**NRND:** Not recommended for new designs. Device is in production to support existing customers, but TI does not recommend using this part in a new design.

**PREVIEW:** Device has been announced but is not in production. Samples may or may not be available.

**OBSOLETE:** TI has discontinued the production of the device.

(2) Eco Plan - The planned eco-friendly classification: Pb-Free (RoHS), Pb-Free (RoHS Exempt), or Green (RoHS & no Sb/Br) - please check <http://www.ti.com/productcontent> for the latest availability information and additional product content details.

**TBD:** The Pb-Free/Green conversion plan has not been defined.

**Pb-Free (RoHS):** TI's terms "Lead-Free" or "Pb-Free" mean semiconductor products that are compatible with the current RoHS requirements for all 6 substances, including the requirement that lead not exceed 0.1% by weight in homogeneous materials. Where designed to be soldered at high temperatures, TI Pb-Free products are suitable for use in specified lead-free processes.

**Pb-Free (RoHS Exempt):** This component has a RoHS exemption for either 1) lead-based flip-chip solder bumps used between the die and package, or 2) lead-based die adhesive used between the die and leadframe. The component is otherwise considered Pb-Free (RoHS compatible) as defined above.

**Green (RoHS & no Sb/Br):** TI defines "Green" to mean Pb-Free (RoHS compatible), and free of Bromine (Br) and Antimony (Sb) based flame retardants (Br or Sb do not exceed 0.1% by weight in homogeneous material)

(3) MSL, Peak Temp. - The Moisture Sensitivity Level rating according to the JEDEC industry standard classifications, and peak solder temperature.

(4) There may be additional marking, which relates to the logo, the lot trace code information, or the environmental category on the device.

(5) Multiple Device Markings will be inside parentheses. Only one Device Marking contained in parentheses and separated by a "~" will appear on a device. If a line is indented then it is a continuation of the previous line and the two combined represent the entire Device Marking for that device.

(6) Lead/Ball Finish - Orderable Devices may have multiple material finish options. Finish options are separated by a vertical ruled line. Lead/Ball Finish values may wrap to two lines if the finish value exceeds the maximum column width.

**Important Information and Disclaimer:**The information provided on this page represents TI's knowledge and belief as of the date that it is provided. TI bases its knowledge and belief on information provided by third parties, and makes no representation or warranty as to the accuracy of such information. Efforts are underway to better integrate information from third parties. TI has taken and continues to take reasonable steps to provide representative and accurate information but may not have conducted destructive testing or chemical analysis on incoming materials and chemicals. TI and TI suppliers consider certain information to be proprietary, and thus CAS numbers and other limited information may not be available for release.

In no event shall TI's liability arising out of such information exceed the total purchase price of the TI part(s) at issue in this document sold by TI to Customer on an annual basis.

**OTHER QUALIFIED VERSIONS OF TLV2252, TLV2252A, TLV2252AM, TLV2252M, TLV2254, TLV2254A, TLV2254AM, TLV2254M, TLV2262AM, TLV2262M :**

- Catalog: [TLV2252A](#), [TLV2252](#), [TLV2254A](#), [TLV2254](#), [TLV2262A](#), [TLV2262](#)
- Automotive: [TLV2252-Q1](#), [TLV2252A-Q1](#), [TLV2252A-Q1](#), [TLV2252-Q1](#), [TLV2254-Q1](#), [TLV2254A-Q1](#), [TLV2254A-Q1](#), [TLV2254-Q1](#), [TLV2262A-Q1](#), [TLV2262-Q1](#)
- Enhanced Product: [TLV2252-EP](#), [TLV2252A-EP](#), [TLV2252A-EP](#), [TLV2252-EP](#), [TLV2254-EP](#), [TLV2254A-EP](#), [TLV2254A-EP](#), [TLV2254-EP](#)
- Military: [TLV2252M](#), [TLV2252AM](#), [TLV2254M](#), [TLV2254AM](#)

NOTE: Qualified Version Definitions:

- Catalog - TI's standard catalog product
- Automotive - Q100 devices qualified for high-reliability automotive applications targeting zero defects
- Enhanced Product - Supports Defense, Aerospace and Medical Applications
- Military - QML certified for Military and Defense Applications

**TAPE AND REEL INFORMATION**

**QUADRANT ASSIGNMENTS FOR PIN 1 ORIENTATION IN TAPE**

\*All dimensions are nominal

Device	Package Type	Package Drawing	Pins	SPQ	Reel Diameter (mm)	Reel Width W1 (mm)	A0 (mm)	B0 (mm)	K0 (mm)	P1 (mm)	W (mm)	Pin1 Quadrant
TLV2252AIDR	SOIC	D	8	2500	330.0	12.4	6.4	5.2	2.1	8.0	12.0	Q1
TLV2252AIPWR	TSSOP	PW	8	2000	330.0	12.4	7.0	3.6	1.6	8.0	12.0	Q1
TLV2252IDR	SOIC	D	8	2500	330.0	12.4	6.4	5.2	2.1	8.0	12.0	Q1
TLV2254AIDR	SOIC	D	14	2500	330.0	16.4	6.5	9.0	2.1	8.0	16.0	Q1
TLV2254AIPWR	TSSOP	PW	14	2000	330.0	12.4	6.9	5.6	1.6	8.0	12.0	Q1
TLV2254IDR	SOIC	D	14	2500	330.0	16.4	6.5	9.0	2.1	8.0	16.0	Q1

**TAPE AND REEL BOX DIMENSIONS**

\*All dimensions are nominal

Device	Package Type	Package Drawing	Pins	SPQ	Length (mm)	Width (mm)	Height (mm)
TLV2252AIDR	SOIC	D	8	2500	340.5	338.1	20.6
TLV2252AIPWR	TSSOP	PW	8	2000	367.0	367.0	35.0
TLV2252IDR	SOIC	D	8	2500	340.5	338.1	20.6
TLV2254AIDR	SOIC	D	14	2500	367.0	367.0	38.0
TLV2254AIPWR	TSSOP	PW	14	2000	367.0	367.0	35.0
TLV2254IDR	SOIC	D	14	2500	367.0	367.0	38.0

JG (R-GDIP-T8)

CERAMIC DUAL-IN-LINE

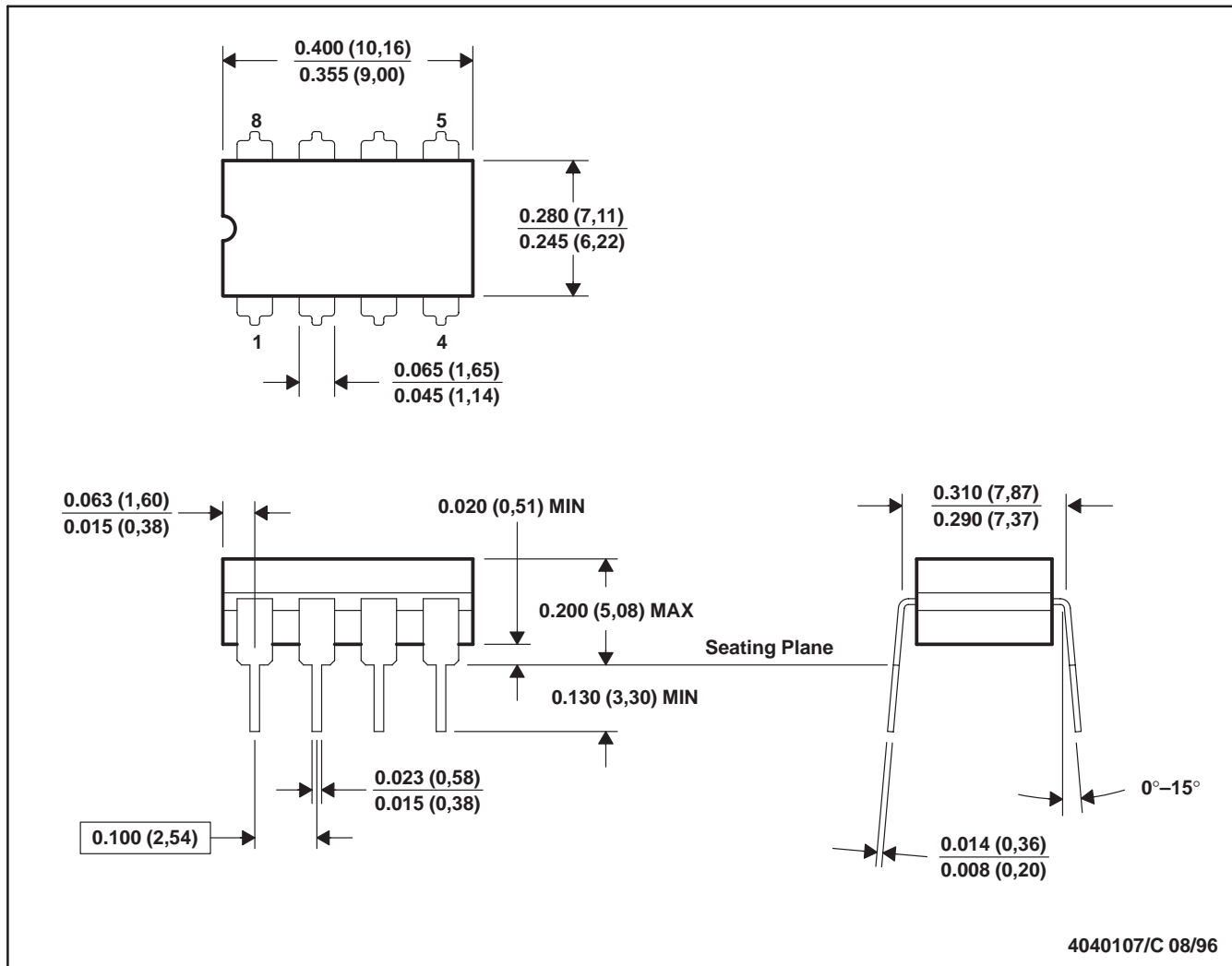

4040107/C 08/96

- NOTES: A. All linear dimensions are in inches (millimeters).  
 B. This drawing is subject to change without notice.  
 C. This package can be hermetically sealed with a ceramic lid using glass frit.  
 D. Index point is provided on cap for terminal identification.  
 E. Falls within MIL STD 1835 GDIP1-T8

U (S-GDFP-F10)

CERAMIC DUAL FLATPACK



- NOTES:
- A. All linear dimensions are in inches (millimeters).
  - B. This drawing is subject to change without notice.
  - C. This package can be hermetically sealed with a ceramic lid using glass frit.
  - D. Index point is provided on cap for terminal identification only.
  - E. Falls within MIL STD 1835 GDFP1-F10 and JEDEC MO-092AA

P (R-PDIP-T8)

PLASTIC DUAL-IN-LINE PACKAGE

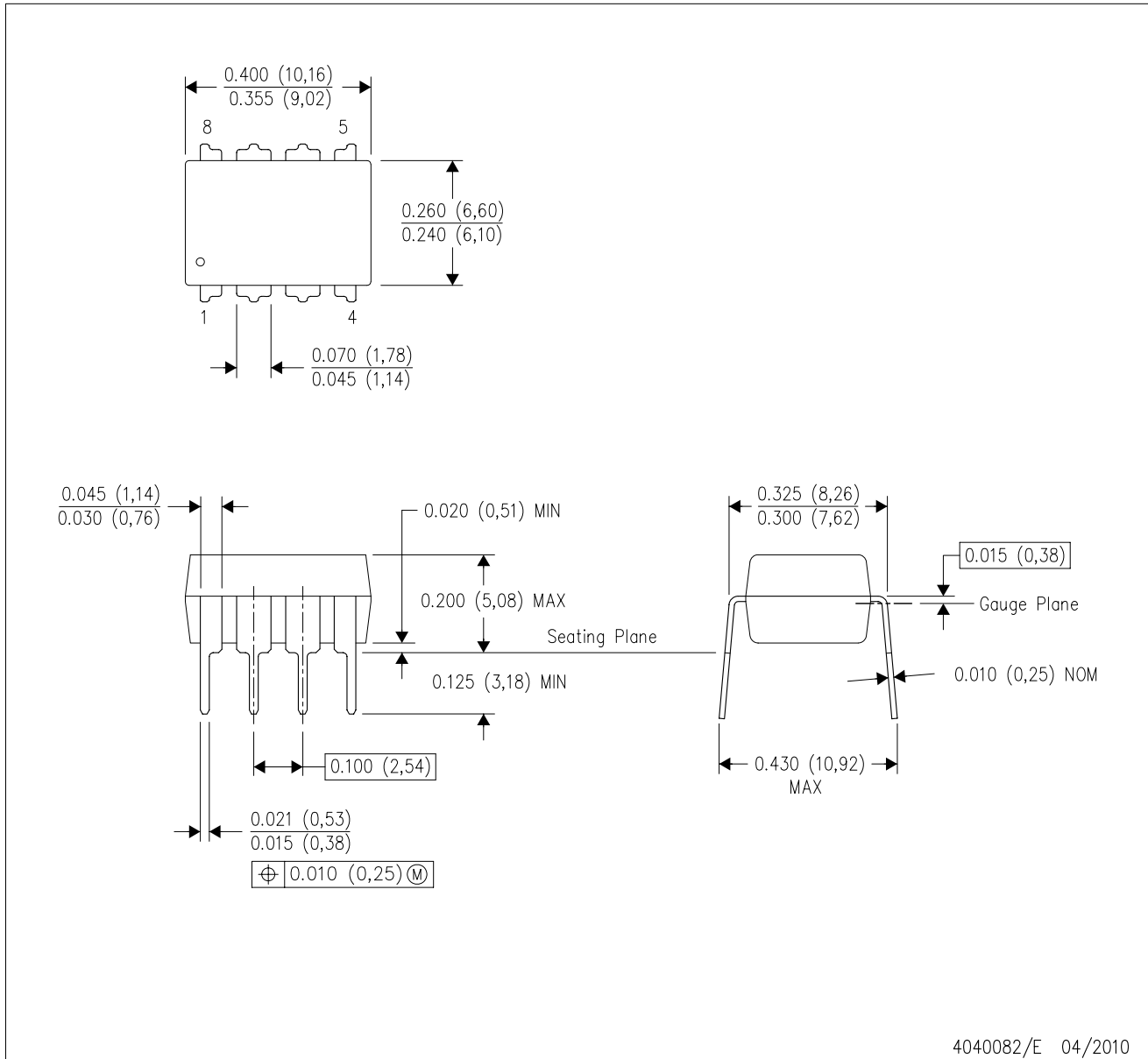

4040082/E 04/2010

N (R-PDIP-T\*\*)

PLASTIC DUAL-IN-LINE PACKAGE

16 PINS SHOWN

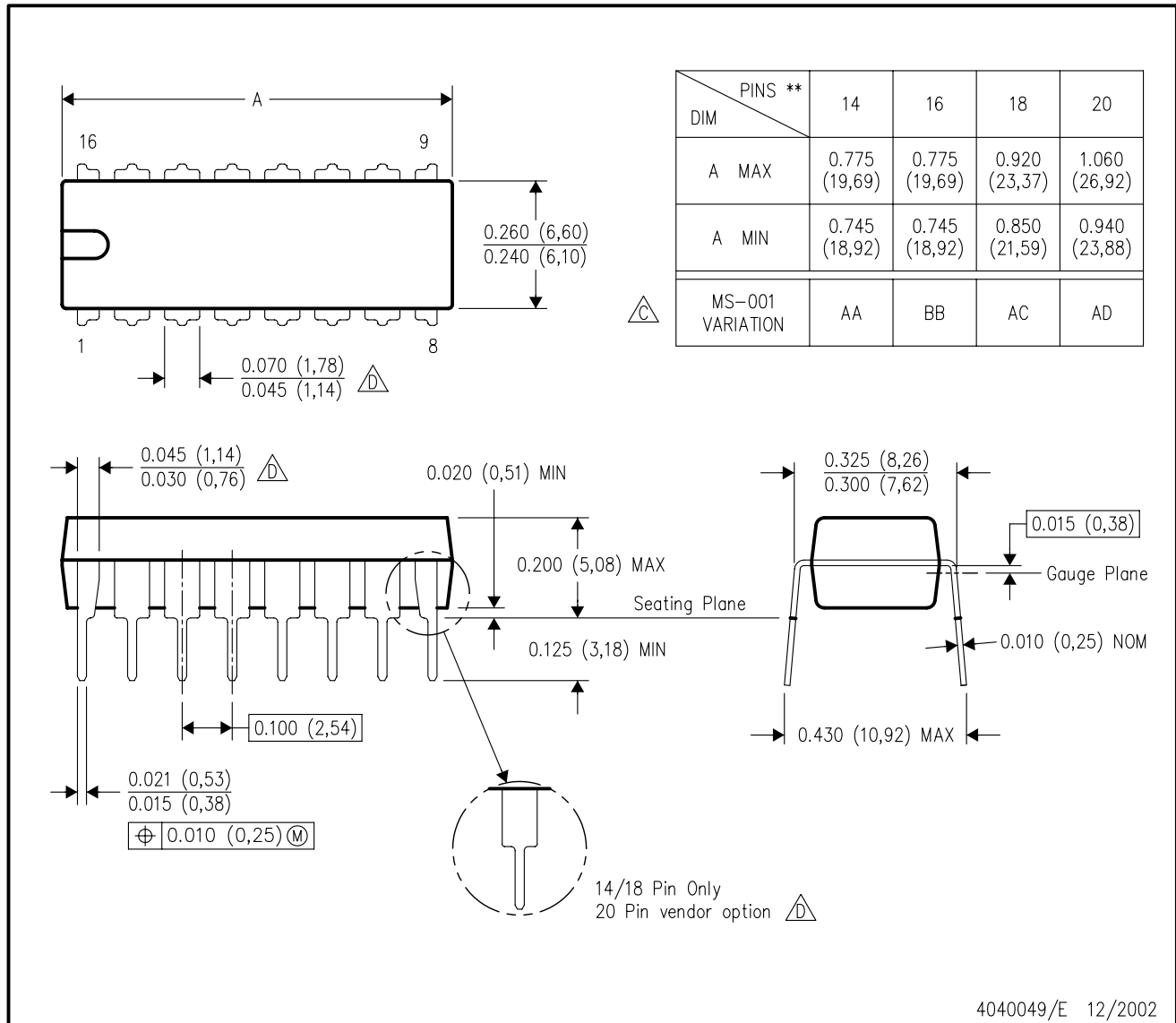

- NOTES:
- A. All linear dimensions are in inches (millimeters).
  - B. This drawing is subject to change without notice.
  - $\triangle C$  Falls within JEDEC MS-001, except 18 and 20 pin minimum body length (Dim A).
  - $\triangle D$  The 20 pin end lead shoulder width is a vendor option, either half or full width.

D (R-PDSO-G14)

PLASTIC SMALL OUTLINE

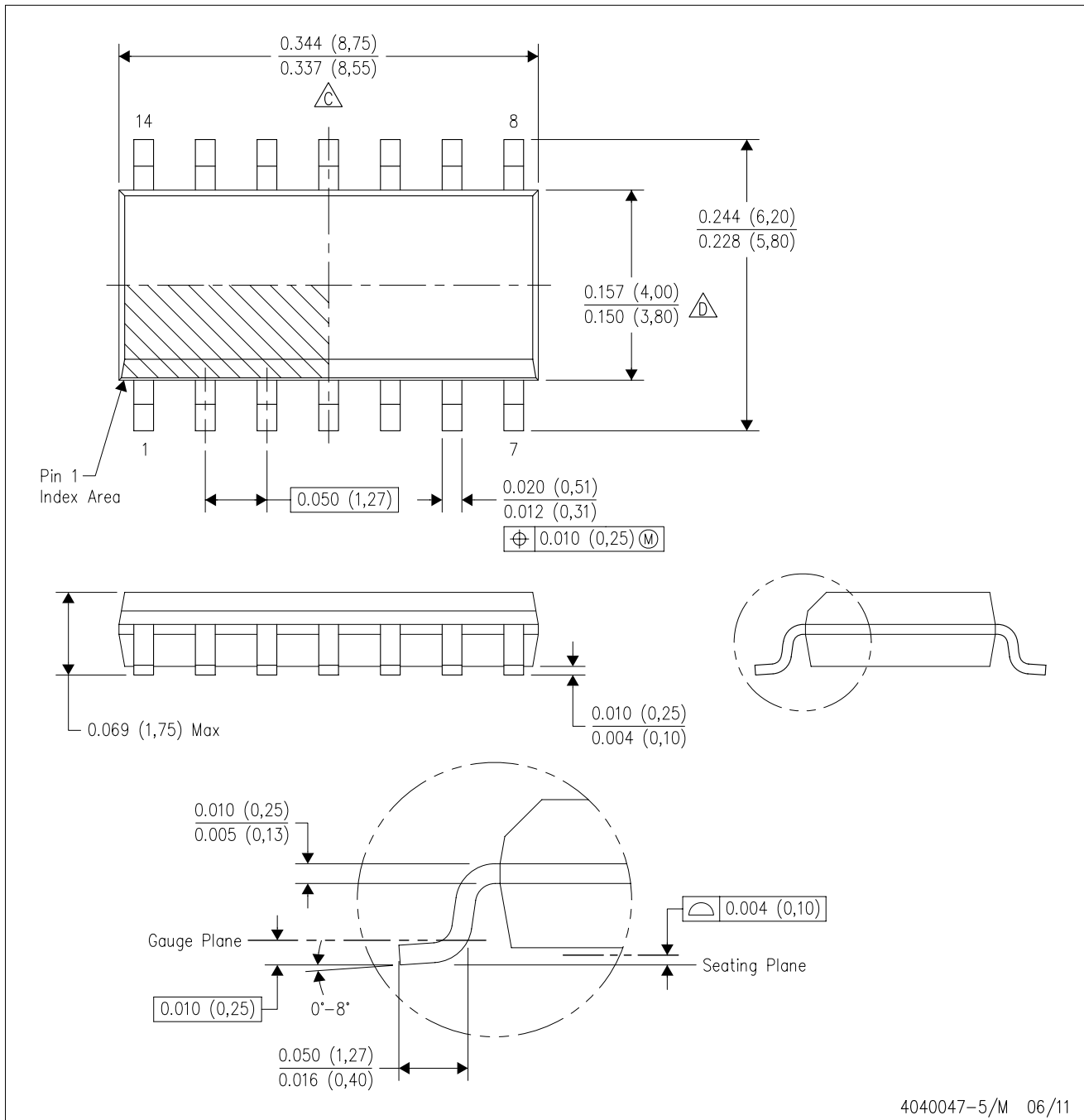

- NOTES:
- A. All linear dimensions are in inches (millimeters).
  - B. This drawing is subject to change without notice.
  - Body length does not include mold flash, protrusions, or gate burrs. Mold flash, protrusions, or gate burrs shall not exceed 0.006 (0,15) each side.
  - Body width does not include interlead flash. Interlead flash shall not exceed 0.017 (0,43) each side.
  - E. Reference JEDEC MS-012 variation AB.

D (R-PDSO-G14)

PLASTIC SMALL OUTLINE

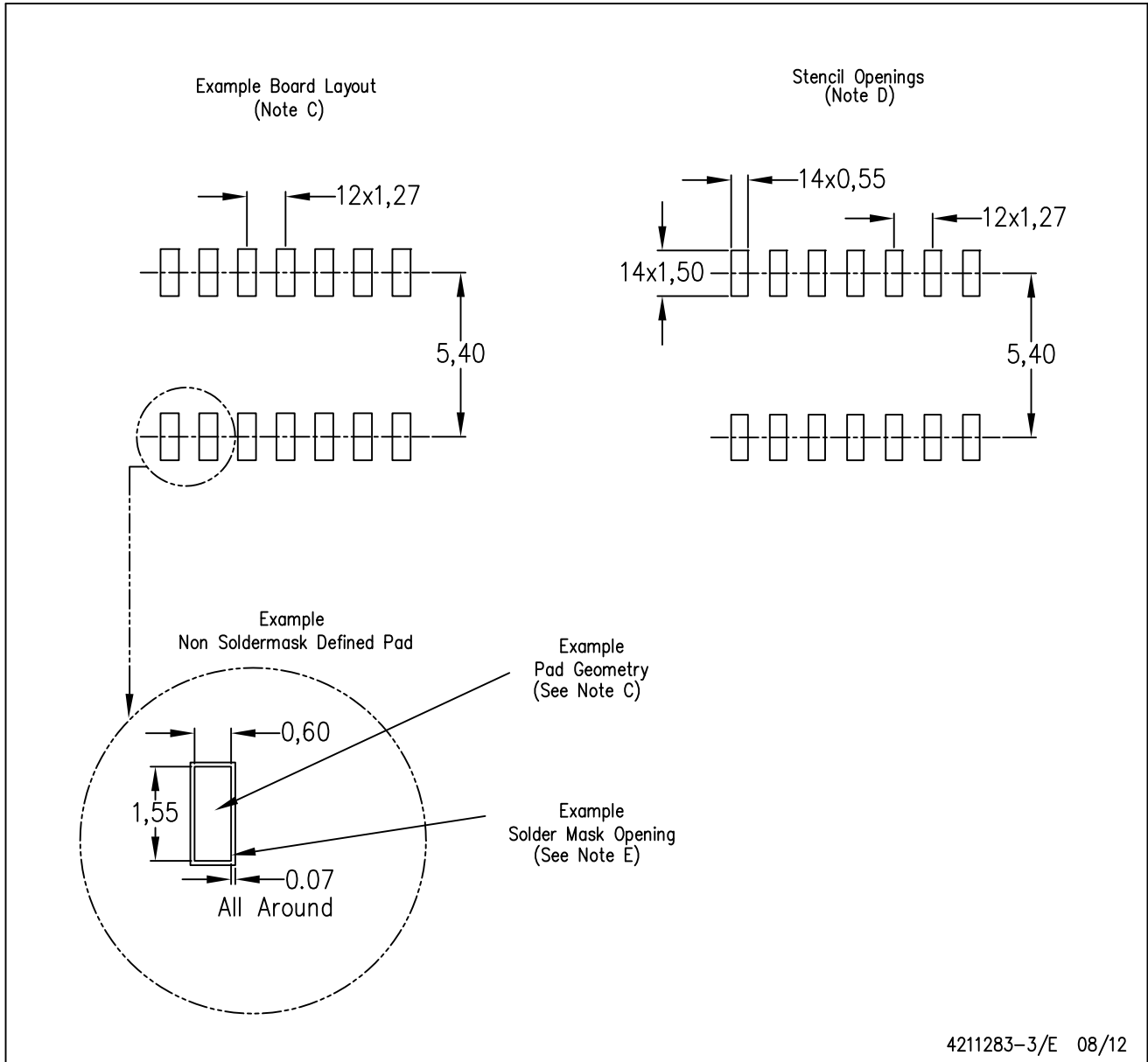

- NOTES:
- All linear dimensions are in millimeters.
  - This drawing is subject to change without notice.
  - Publication IPC-7351 is recommended for alternate designs.
  - Laser cutting apertures with trapezoidal walls and also rounding corners will offer better paste release. Customers should contact their board assembly site for stencil design recommendations. Refer to IPC-7525 for other stencil recommendations.
  - Customers should contact their board fabrication site for solder mask tolerances between and around signal pads.

PW (R-PDSO-G14)

PLASTIC SMALL OUTLINE

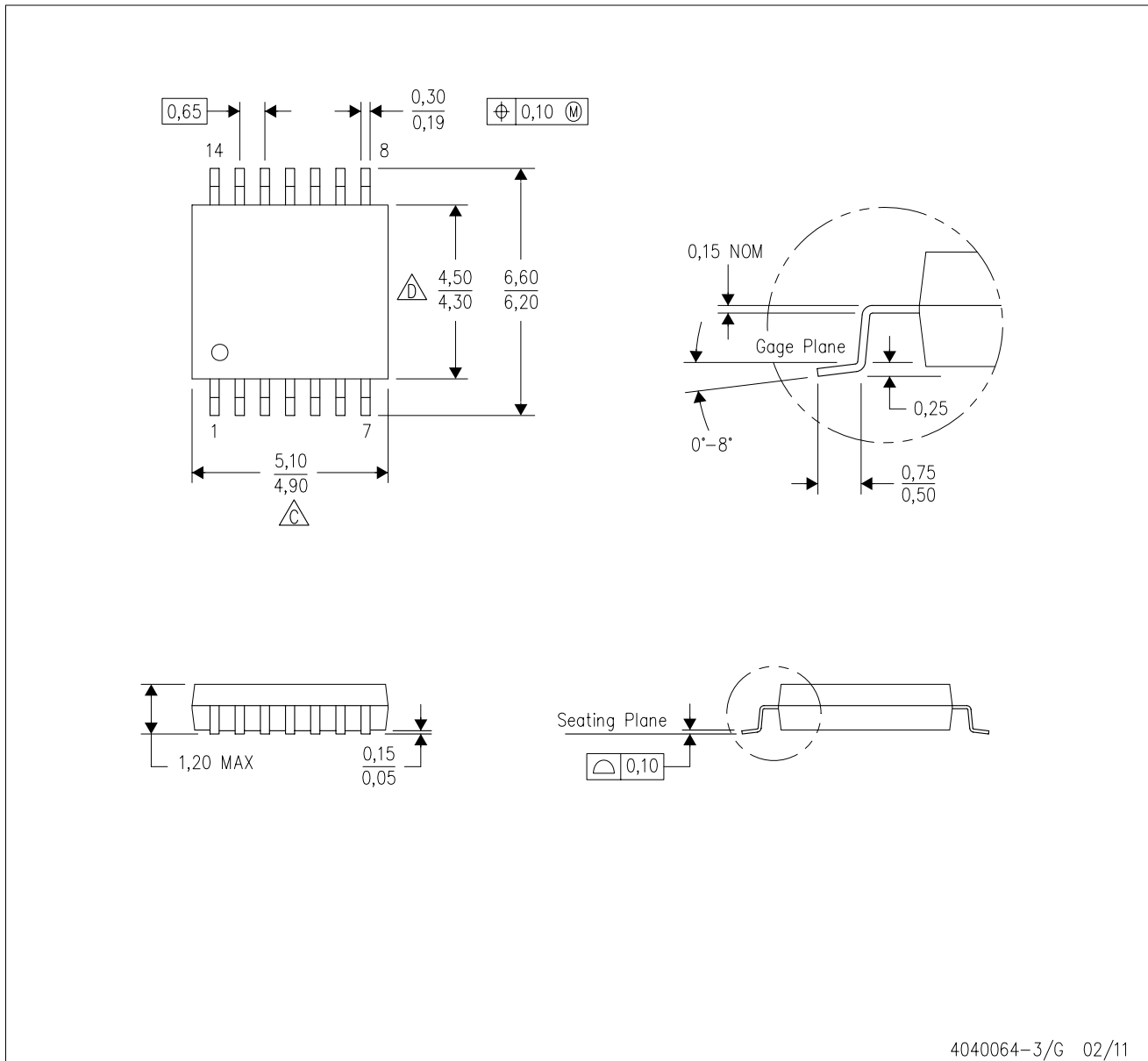

4040064-3/G 02/11

- NOTES:
- A. All linear dimensions are in millimeters. Dimensioning and tolerancing per ASME Y14.5M-1994.
  - B. This drawing is subject to change without notice.
  - C. Body length does not include mold flash, protrusions, or gate burrs. Mold flash, protrusions, or gate burrs shall not exceed 0,15 each side.
  - D. Body width does not include interlead flash. Interlead flash shall not exceed 0,25 each side.
  - E. Falls within JEDEC MO-153

PW (R-PDSO-G14)

PLASTIC SMALL OUTLINE

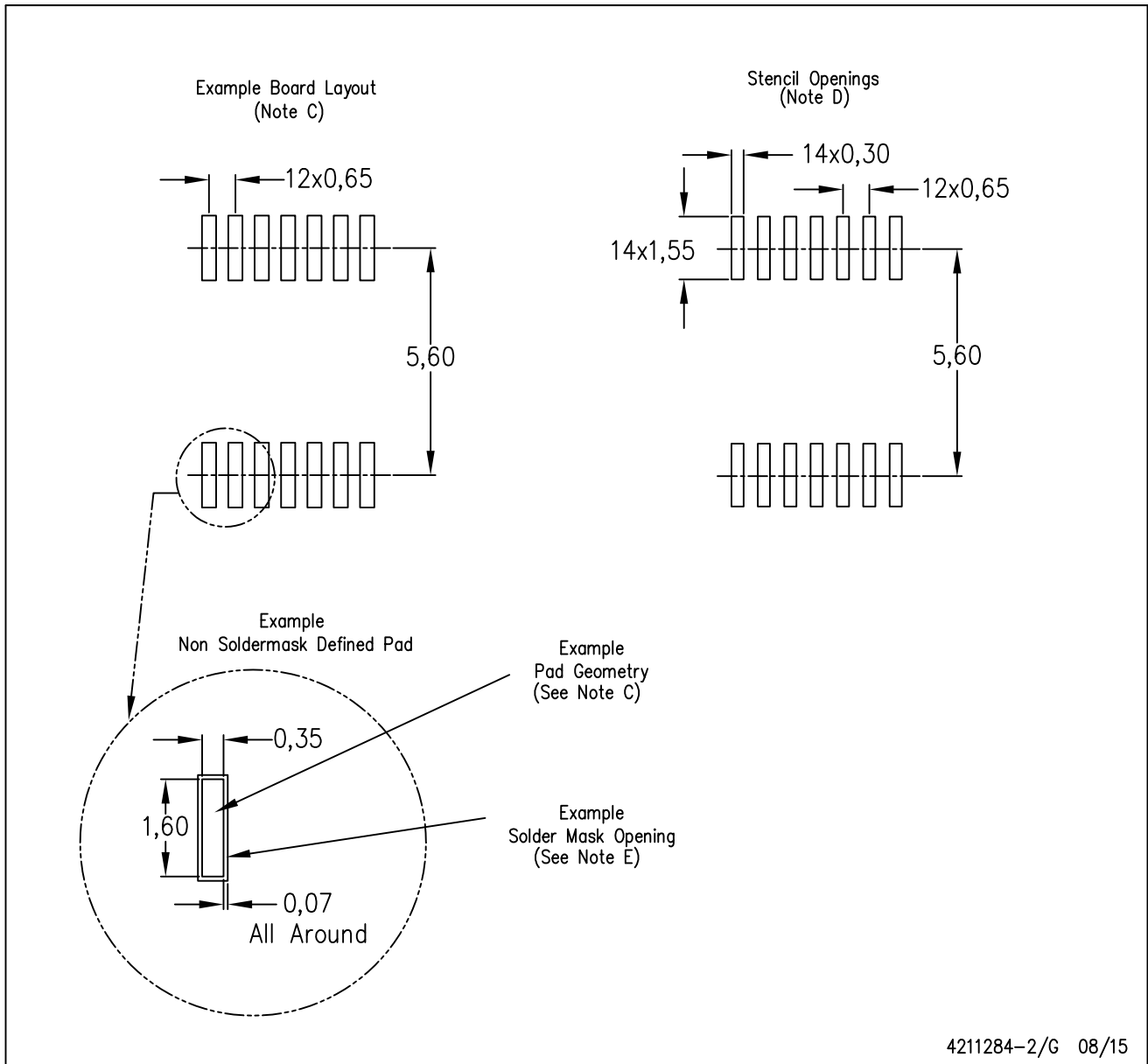

- NOTES:
- All linear dimensions are in millimeters.
  - This drawing is subject to change without notice.
  - Publication IPC-7351 is recommended for alternate designs.
  - Laser cutting apertures with trapezoidal walls and also rounding corners will offer better paste release. Customers should contact their board assembly site for stencil design recommendations. Refer to IPC-7525 for other stencil recommendations.
  - Customers should contact their board fabrication site for solder mask tolerances between and around signal pads.

PW0008A



# PACKAGE OUTLINE

## TSSOP - 1.2 mm max height

SMALL OUTLINE PACKAGE



4221848/A 02/2015

### NOTES:

1. All linear dimensions are in millimeters. Any dimensions in parenthesis are for reference only. Dimensioning and tolerancing per ASME Y14.5M.
2. This drawing is subject to change without notice.
3. This dimension does not include mold flash, protrusions, or gate burrs. Mold flash, protrusions, or gate burrs shall not exceed 0.15 mm per side.
4. This dimension does not include interlead flash. Interlead flash shall not exceed 0.25 mm per side.
5. Reference JEDEC registration MO-153, variation AA.

# EXAMPLE BOARD LAYOUT

PW0008A

TSSOP - 1.2 mm max height

SMALL OUTLINE PACKAGE



LAND PATTERN EXAMPLE  
SCALE:10X



SOLDER MASK DETAILS  
NOT TO SCALE

4221848/A 02/2015

NOTES: (continued)

- 6. Publication IPC-7351 may have alternate designs.
- 7. Solder mask tolerances between and around signal pads can vary based on board fabrication site.

# EXAMPLE STENCIL DESIGN

PW0008A

TSSOP - 1.2 mm max height

SMALL OUTLINE PACKAGE



SOLDER PASTE EXAMPLE  
BASED ON 0.125 mm THICK STENCIL  
SCALE:10X

4221848/A 02/2015

NOTES: (continued)

8. Laser cutting apertures with trapezoidal walls and rounded corners may offer better paste release. IPC-7525 may have alternate design recommendations.
9. Board assembly site may have different recommendations for stencil design.

D (R-PDSO-G8)

PLASTIC SMALL OUTLINE

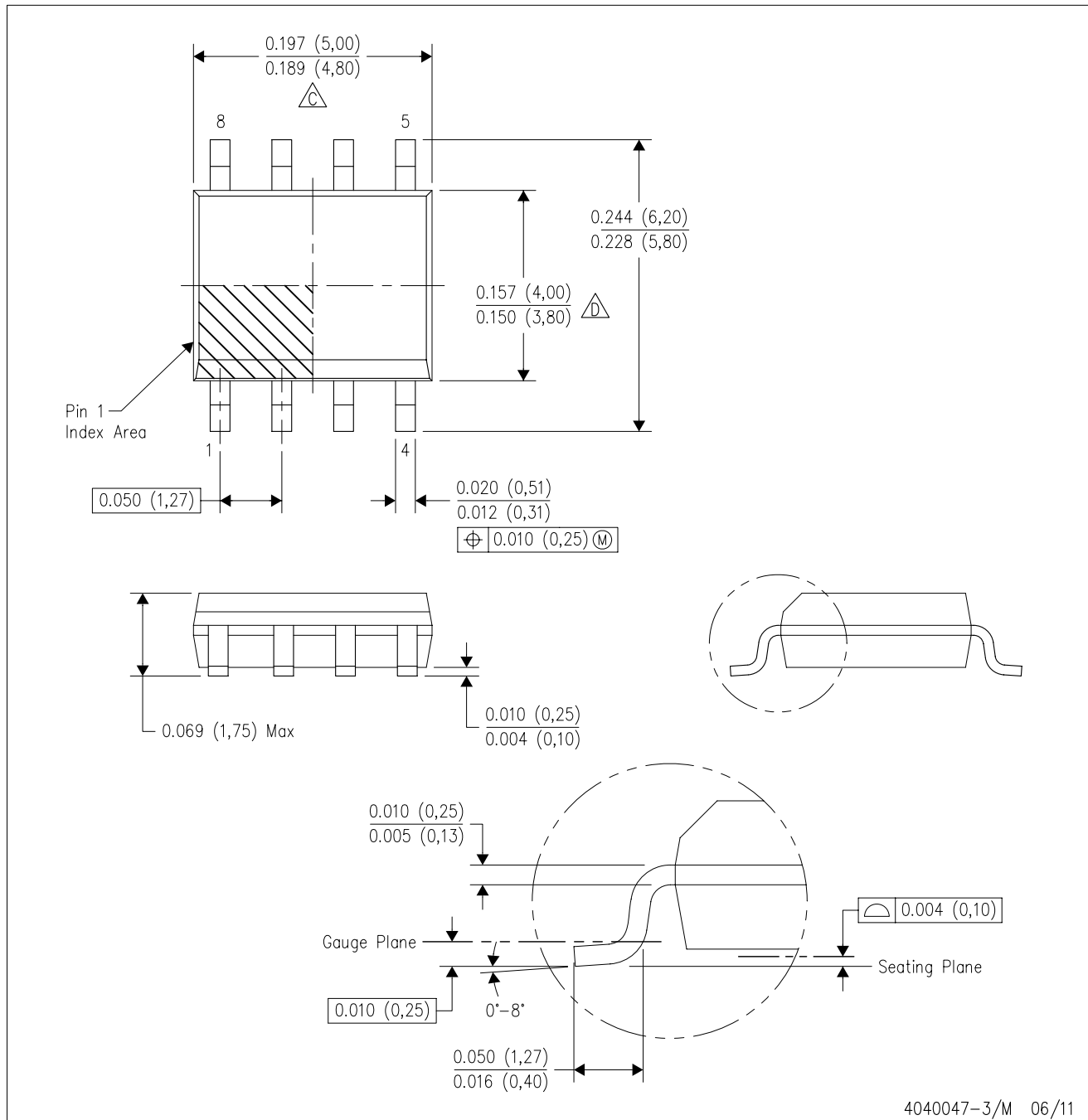

D (R-PDSO-G8)

PLASTIC SMALL OUTLINE

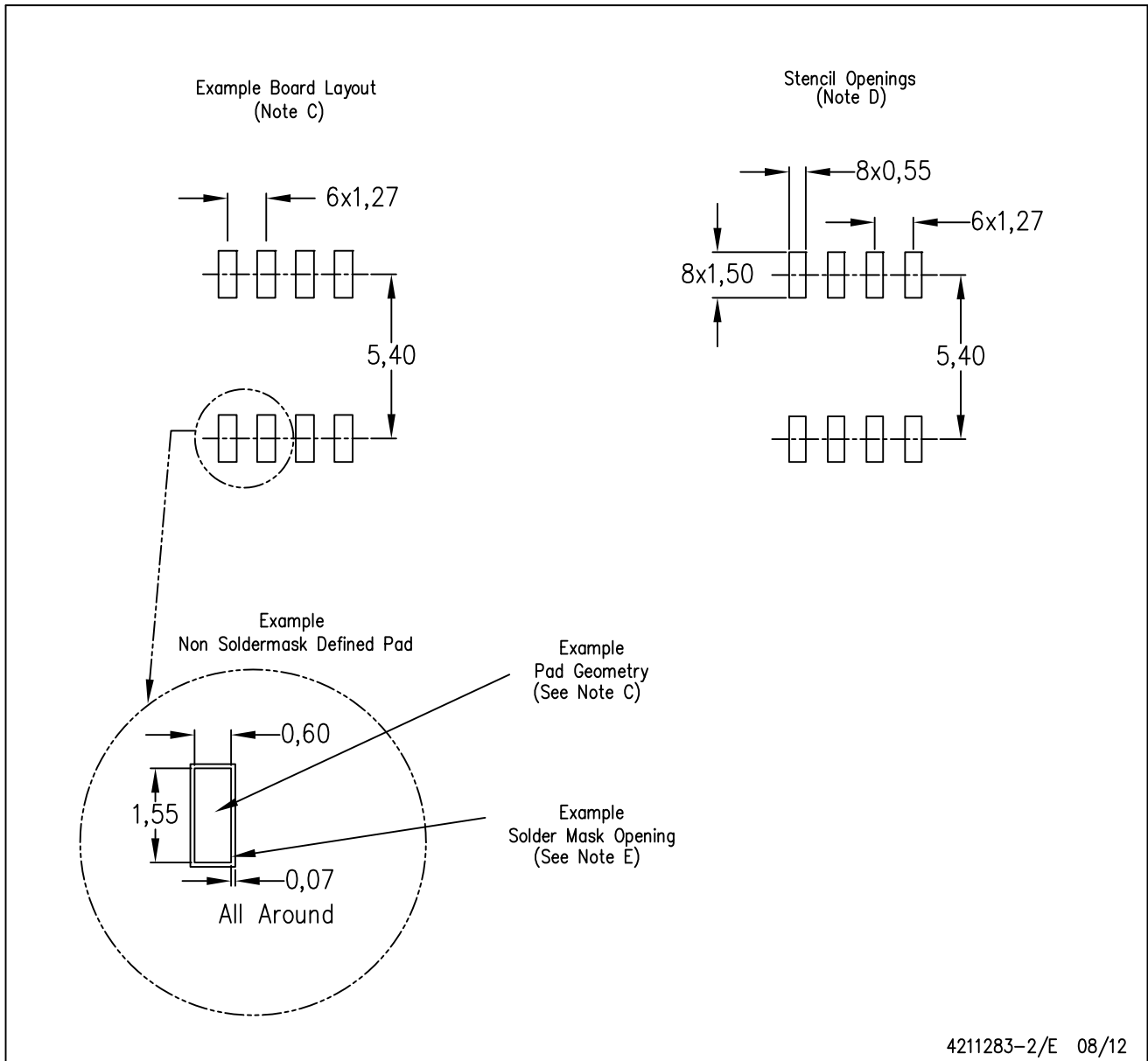

4211283-2/E 08/12

- NOTES:
- All linear dimensions are in millimeters.
  - This drawing is subject to change without notice.
  - Publication IPC-7351 is recommended for alternate designs.
  - Laser cutting apertures with trapezoidal walls and also rounding corners will offer better paste release. Customers should contact their board assembly site for stencil design recommendations. Refer to IPC-7525 for other stencil recommendations.
  - Customers should contact their board fabrication site for solder mask tolerances between and around signal pads.

## IMPORTANT NOTICE

Texas Instruments Incorporated and its subsidiaries (TI) reserve the right to make corrections, enhancements, improvements and other changes to its semiconductor products and services per JESD46, latest issue, and to discontinue any product or service per JESD48, latest issue. Buyers should obtain the latest relevant information before placing orders and should verify that such information is current and complete. All semiconductor products (also referred to herein as "components") are sold subject to TI's terms and conditions of sale supplied at the time of order acknowledgment.

TI warrants performance of its components to the specifications applicable at the time of sale, in accordance with the warranty in TI's terms and conditions of sale of semiconductor products. Testing and other quality control techniques are used to the extent TI deems necessary to support this warranty. Except where mandated by applicable law, testing of all parameters of each component is not necessarily performed.

TI assumes no liability for applications assistance or the design of Buyers' products. Buyers are responsible for their products and applications using TI components. To minimize the risks associated with Buyers' products and applications, Buyers should provide adequate design and operating safeguards.

TI does not warrant or represent that any license, either express or implied, is granted under any patent right, copyright, mask work right, or other intellectual property right relating to any combination, machine, or process in which TI components or services are used. Information published by TI regarding third-party products or services does not constitute a license to use such products or services or a warranty or endorsement thereof. Use of such information may require a license from a third party under the patents or other intellectual property of the third party, or a license from TI under the patents or other intellectual property of TI.

Reproduction of significant portions of TI information in TI data books or data sheets is permissible only if reproduction is without alteration and is accompanied by all associated warranties, conditions, limitations, and notices. TI is not responsible or liable for such altered documentation. Information of third parties may be subject to additional restrictions.

Resale of TI components or services with statements different from or beyond the parameters stated by TI for that component or service voids all express and any implied warranties for the associated TI component or service and is an unfair and deceptive business practice. TI is not responsible or liable for any such statements.

Buyer acknowledges and agrees that it is solely responsible for compliance with all legal, regulatory and safety-related requirements concerning its products, and any use of TI components in its applications, notwithstanding any applications-related information or support that may be provided by TI. Buyer represents and agrees that it has all the necessary expertise to create and implement safeguards which anticipate dangerous consequences of failures, monitor failures and their consequences, lessen the likelihood of failures that might cause harm and take appropriate remedial actions. Buyer will fully indemnify TI and its representatives against any damages arising out of the use of any TI components in safety-critical applications.

In some cases, TI components may be promoted specifically to facilitate safety-related applications. With such components, TI's goal is to help enable customers to design and create their own end-product solutions that meet applicable functional safety standards and requirements. Nonetheless, such components are subject to these terms.

No TI components are authorized for use in FDA Class III (or similar life-critical medical equipment) unless authorized officers of the parties have executed a special agreement specifically governing such use.

Only those TI components which TI has specifically designated as military grade or "enhanced plastic" are designed and intended for use in military/aerospace applications or environments. Buyer acknowledges and agrees that any military or aerospace use of TI components which have **not** been so designated is solely at the Buyer's risk, and that Buyer is solely responsible for compliance with all legal and regulatory requirements in connection with such use.

TI has specifically designated certain components as meeting ISO/TS16949 requirements, mainly for automotive use. In any case of use of non-designated products, TI will not be responsible for any failure to meet ISO/TS16949.

### Products

Audio	<a href="http://www.ti.com/audio">www.ti.com/audio</a>
Amplifiers	<a href="http://amplifier.ti.com">amplifier.ti.com</a>
Data Converters	<a href="http://dataconverter.ti.com">dataconverter.ti.com</a>
DLP® Products	<a href="http://www.dlp.com">www.dlp.com</a>
DSP	<a href="http://dsp.ti.com">dsp.ti.com</a>
Clocks and Timers	<a href="http://www.ti.com/clocks">www.ti.com/clocks</a>
Interface	<a href="http://interface.ti.com">interface.ti.com</a>
Logic	<a href="http://logic.ti.com">logic.ti.com</a>
Power Mgmt	<a href="http://power.ti.com">power.ti.com</a>
Microcontrollers	<a href="http://microcontroller.ti.com">microcontroller.ti.com</a>
RFID	<a href="http://www.ti-rfid.com">www.ti-rfid.com</a>
OMAP Applications Processors	<a href="http://www.ti.com/omap">www.ti.com/omap</a>
Wireless Connectivity	<a href="http://www.ti.com/wirelessconnectivity">www.ti.com/wirelessconnectivity</a>

### Applications

Automotive and Transportation	<a href="http://www.ti.com/automotive">www.ti.com/automotive</a>
Communications and Telecom	<a href="http://www.ti.com/communications">www.ti.com/communications</a>
Computers and Peripherals	<a href="http://www.ti.com/computers">www.ti.com/computers</a>
Consumer Electronics	<a href="http://www.ti.com/consumer-apps">www.ti.com/consumer-apps</a>
Energy and Lighting	<a href="http://www.ti.com/energy">www.ti.com/energy</a>
Industrial	<a href="http://www.ti.com/industrial">www.ti.com/industrial</a>
Medical	<a href="http://www.ti.com/medical">www.ti.com/medical</a>
Security	<a href="http://www.ti.com/security">www.ti.com/security</a>
Space, Avionics and Defense	<a href="http://www.ti.com/space-avionics-defense">www.ti.com/space-avionics-defense</a>
Video and Imaging	<a href="http://www.ti.com/video">www.ti.com/video</a>

### TI E2E Community

[e2e.ti.com](http://e2e.ti.com)