

# TLV2432, TLV2432A, TLV2434, TLV2434A Advanced LinCMOS™ RAIL-TO-RAIL OUTPUT WIDE-INPUT-VOLTAGE OPERATIONAL AMPLIFIERS

SLOS168F – NOVEMBER 1996 – REVISED MARCH 2001

- Output Swing Includes Both Supply Rails
- Extended Common-Mode Input Voltage Range . . . 0 V to 4.5 V (Min) with 5-V Single Supply
- No Phase Inversion
- Low Noise . . . 18 nV/√Hz Typ at f = 1 kHz
- Low Input Offset Voltage  
950 μV Max at T<sub>A</sub> = 25°C (TLV243xA)
- Low Input Bias Current . . . 1 pA Typ
- Very Low Supply Current . . . 125 μA Per Channel Max
- 600-Ω Output Drive
- Macromodel Included
- Available in Q-Temp Automotive HighRel Automotive Applications Configuration Control / Print Support Qualification to Automotive Standards

## description

The TLV243x and TLV243xA are low-voltage operational amplifier from Texas Instruments. The common-mode input voltage range for each device is extended over the typical CMOS amplifiers making them suitable for a wide range of applications. In addition, these devices do not phase invert when the common-mode input is driven to the supply rails. This satisfies most design requirements without paying a premium for rail-to-rail input performance. They also exhibit rail-to-rail output performance for increased dynamic range in single- or split-supply applications. This family is fully characterized at 3-V and 5-V supplies and is optimized for low-voltage operation. The TLV243x only requires 100 μA (typ) of supply current per channel, making it ideal for battery-powered applications. The TLV243x also has increased output drive over previous rail-to-rail operational amplifiers and can drive 600-Ω loads for telecom applications.

The other members in the TLV243x family are the high-power, TLV244x, and micro-power, TLV2422, versions.

The TLV243x, exhibiting high input impedance and low noise, is excellent for small-signal conditioning for high-impedance sources, such as piezoelectric transducers. Because of the micropower dissipation levels and low-voltage operation, these devices work well in hand-held monitoring and remote-sensing applications. In addition, the rail-to-rail output feature with single- or split-supplies makes this family a great choice when interfacing with analog-to-digital converters (ADCs). For precision applications, the TLV243xA is available and has a maximum input offset voltage of 950 μV.

If the design requires single operational amplifiers, see the TI TLV2211/21/31. This is a family of rail-to-rail output operational amplifiers in the SOT-23 package. Their small size and low power consumption, make them ideal for high density, battery-powered equipment.

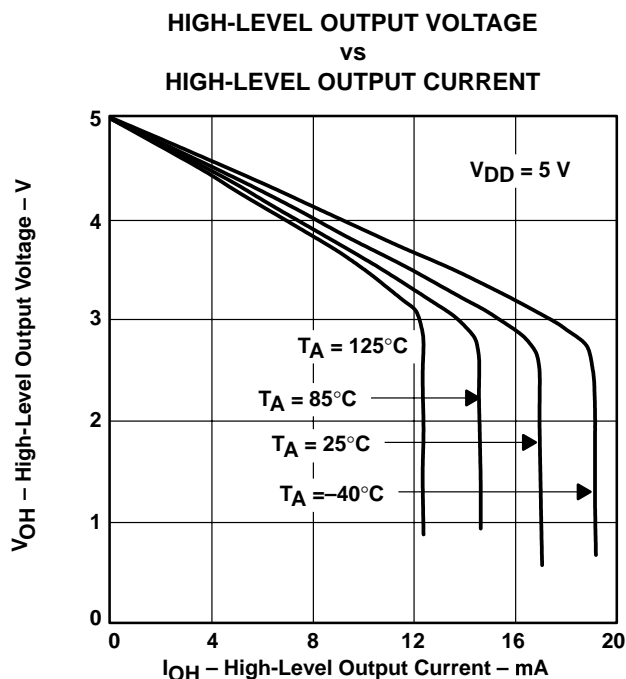

Figure 1



Please be aware that an important notice concerning availability, standard warranty, and use in critical applications of Texas Instruments semiconductor products and disclaimers thereto appears at the end of this data sheet.

Advanced LinCMOS is a trademark of Texas Instruments.

PRODUCTION DATA information is current as of publication date. Products conform to specifications per the terms of Texas Instruments standard warranty. Production processing does not necessarily include testing of all parameters.

 **TEXAS  
INSTRUMENTS**

POST OFFICE BOX 655303 • DALLAS, TEXAS 75265

Copyright © 2001, Texas Instruments Incorporated  
On products compliant to MIL-PRF-38535, all parameters are tested unless otherwise noted. On all other products, production processing does not necessarily include testing of all parameters.

# TLV2432, TLV2432A, TLV2434, TLV2434A

## Advanced LinCMOS™ RAIL-TO-RAIL OUTPUT

### WIDE-INPUT-VOLTAGE OPERATIONAL AMPLIFIERS

SLOS168F – NOVEMBER 1996 – REVISED MARCH 2001

#### TLV2432 and TLV2432A AVAILABLE OPTIONS

| T <sub>A</sub> | V <sub>IO</sub> max AT 25°C | PACKAGED DEVICES        |                           |                           |                  |                         |
|----------------|-----------------------------|-------------------------|---------------------------|---------------------------|------------------|-------------------------|
|                |                             | SMALL OUTLINE (D)       | CHIP CARRIER (FK)         | CERAMIC DIP (JG)          | TSSOP (PW)       | CERAMIC FLAT PACK (U)   |
| 0°C to 70°C    | 2.5 mV                      | TLV2432CD               | —                         | —                         | TLV2432CPW       | —                       |
| –40°C to 85°C  | 950 μV<br>2.5 mV            | TLV2432AID<br>TLV2432ID | —<br>—                    | —<br>—                    | TLV2432AIPW<br>— | —<br>—                  |
| –40°C to 125°C | 950 μV<br>2.5 mV            | TLV2432AQD<br>TLV2432QD | —<br>—                    | —<br>—                    | —<br>—           | —<br>—                  |
| –55°C to 125°C | 950 μV<br>2.5 mV            | —<br>—                  | TLV2432AMFK<br>TLV2432MFK | TLV2432AMJG<br>TLV2432MJG | —<br>—           | TLV2432AMU<br>TLV2432MU |

The D packages are available taped and reeled. Add R suffix to device type (e.g., TLV2432CDR). The PW package is available only left-end taped and reeled.

#### TLV2434 AVAILABLE OPTIONS

| T <sub>A</sub> | V <sub>IO</sub> max AT 25°C | PACKAGED DEVICES        |                           |
|----------------|-----------------------------|-------------------------|---------------------------|
|                |                             | SMALL OUTLINE (D)       | TSSOP (PW)                |
| 0°C to 70°C    | 2.5 mV                      | TLV2434CD               | TLV2434CPW                |
| –40°C to 125°C | 950 μV<br>2.5 mV            | TLV2434AID<br>TLV2434ID | TLV2434AIPW<br>TLV2434IPW |

The D packages are available taped and reeled. Add R suffix to device type (e.g., TLV2434CDR). The PW package is available only left-end taped and reeled.

**TLV2432  
D OR JG PACKAGE  
(TOP VIEW)**

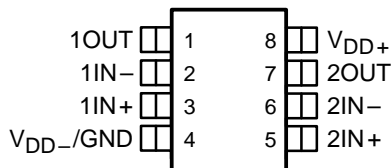

**TLV2432  
PW PACKAGE  
(TOP VIEW)**

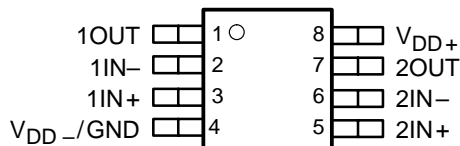

**TLV2432  
FK PACKAGE  
(TOP VIEW)**

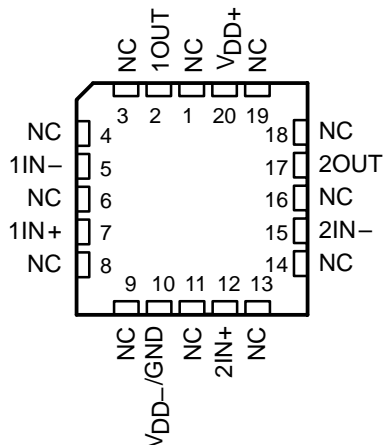

**TLV2432  
U PACKAGE  
(TOP VIEW)**

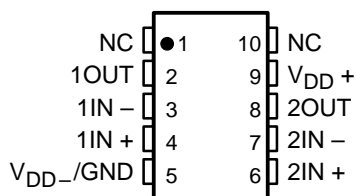

**TLV2434  
D OR PW PACKAGE  
(TOP VIEW)**

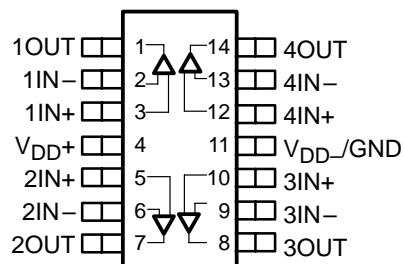

NC – No internal connection



POST OFFICE BOX 655303 • DALLAS, TEXAS 75265

TLV2432, TLV2432A, TLV2434, TLV2434A  
 Advanced LINCOS™ RAIL-TO-RAIL OUTPUT  
 WIDE-INPUT-VOLTAGE OPERATIONAL AMPLIFIERS

SLOS168F – NOVEMBER 1996 – REVISED MARCH 2001

equivalent schematic (each amplifier)

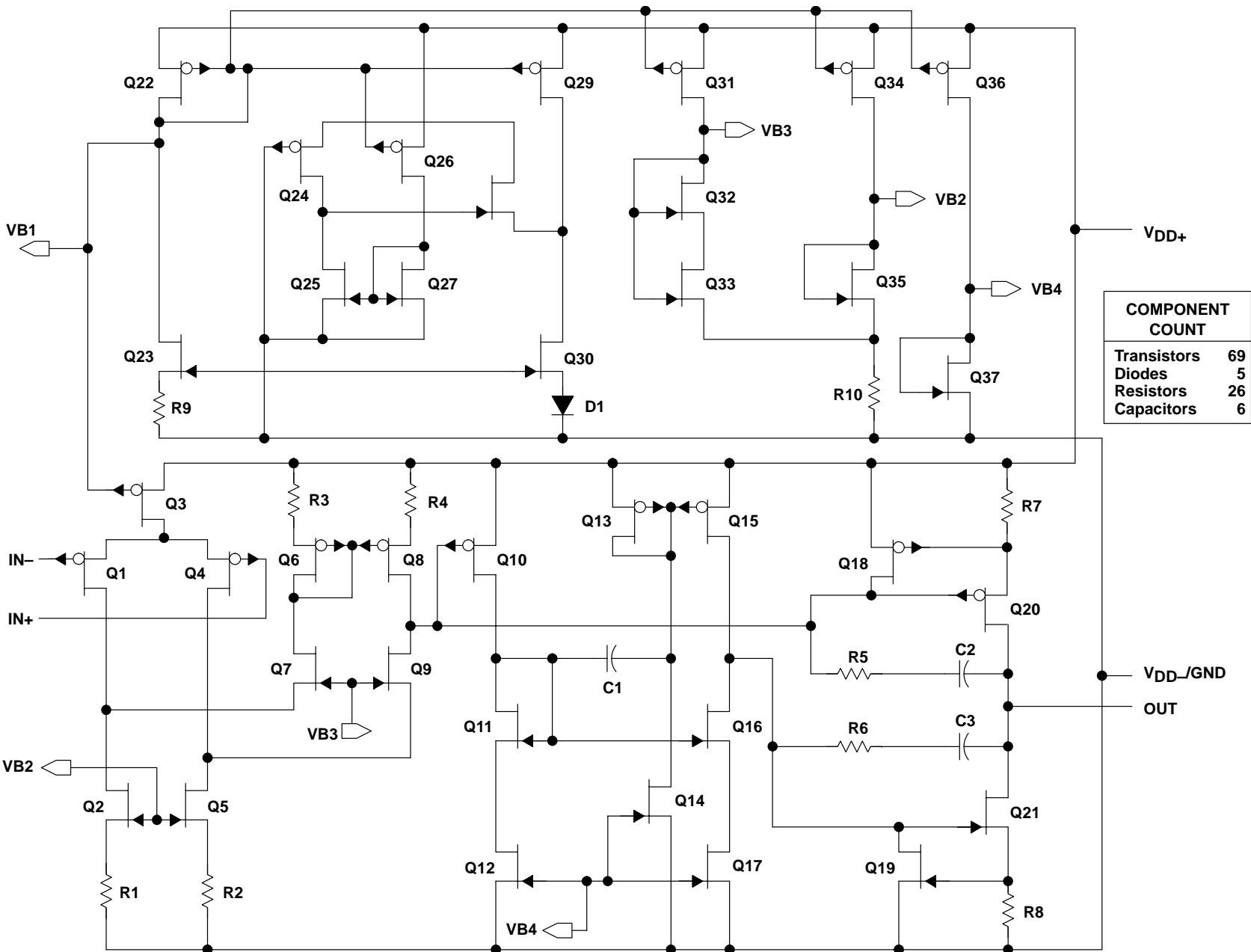

| COMPONENT COUNT |    |
|-----------------|----|
| Transistors     | 69 |
| Diodes          | 5  |
| Resistors       | 26 |
| Capacitors      | 6  |

**TLV2432, TLV2432A, TLV2434, TLV2434A**  
**Advanced LinCMOS™ RAIL-TO-RAIL OUTPUT**  
**WIDE-INPUT-VOLTAGE OPERATIONAL AMPLIFIERS**

SLOS168F – NOVEMBER 1996 – REVISED MARCH 2001

**absolute maximum ratings over operating free-air temperature range (unless otherwise noted)†**

|   |                              |
|---|------------------------------|
| Supply voltage, $V_{DD}$ (see Note 1)                             | 12 V                         |
| Differential input voltage, $V_{ID}$ (see Note 2)                 | $\pm V_{DD}$                 |
| Input voltage, $V_I$ (any input, see Note 1): C and I suffix      | -0.3 V to $V_{DD}$           |
| Input current, $I_I$ (each input)                                 | $\pm 5$ mA                   |
| Output current, $I_O$   | $\pm 50$ mA                  |
| Total current into $V_{DD+}$                                      | $\pm 50$ mA                  |
| Total current out of $V_{DD-}$                                    | $\pm 50$ mA                  |
| Duration of short-circuit current at (or below) 25°C (see Note 3) | unlimited                    |
| Continuous total dissipation                                      | See Dissipation Rating Table |
| Operating free-air temperature range, $T_A$ : C suffix            | 0°C to 70°C                  |
| I suffix (dual)   | -40°C to 85°C                |
| I suffix (quad)   | -40°C to 125°C               |
| Q suffix  | -40°C to 125°C               |
| M suffix  | -55°C to 125°C               |
| Storage temperature range, $T_{stg}$                              | -65°C to 150°C               |
| Lead temperature 1,6 mm (1/16 inch) from case for 10 seconds      | 260°C                        |

† Stresses beyond those listed under “absolute maximum ratings” may cause permanent damage to the device. These are stress ratings only, and functional operation of the device at these or any other conditions beyond those indicated under “recommended operating conditions” is not implied. Exposure to absolute-maximum-rated conditions for extended periods may affect device reliability.

- NOTES: 1. All voltage values, except differential voltages, are with respect to the midpoint between  $V_{DD+}$  and  $V_{DD-}$ .  
 2. Differential voltages are at  $IN+$  with respect to  $IN-$ . Excessive current flows if input is brought below  $V_{DD-} - 0.3$  V.  
 3. The output may be shorted to either supply. Temperature and/or supply voltages must be limited to ensure that the maximum dissipation rating is not exceeded.

**DISSIPATION RATING TABLE**

| PACKAGE | $T_A \leq 25^\circ\text{C}$<br>POWER RATING | DERATING FACTOR<br>ABOVE $T_A = 25^\circ\text{C}$ | $T_A = 70^\circ\text{C}$<br>POWER RATING | $T_A = 85^\circ\text{C}$<br>POWER RATING | $T_A = 125^\circ\text{C}$<br>POWER RATING |
|---------|---|---|--|--|---|
| D (8)   | 725 mW                                      | 5.8 mW/°C   | 464 mW                                   | 377 mW                                   | 145 mW                                    |
| D (14)  | 1022 mW                                     | 7.6 mW/°C   | 900 mW                                   | 777 mW                                   | 450 mW                                    |
| FK      | 1375 mW                                     | 11.0 mW/°C  | 880 mW                                   | 715 mW                                   | 275 mW                                    |
| JG      | 1050 mW                                     | 8.4 mW/°C   | 672 mW                                   | 546 mW                                   | 210 mW                                    |
| PW (8)  | 525 mW                                      | 4.2 mW/°C   | 336 mW                                   | 273 mW                                   | 105 mW                                    |
| PW (14) | 720 mW                                      | 5.6 mW/°C   | 634 mW                                   | 547 mW                                   | 317 mW                                    |
| U       | 675 mW                                      | 5.4 mW/°C   | 432 mW                                   | 350 mW                                   | 135 mW                                    |

**recommended operating conditions**

|                                       | C SUFFIX  |                 | I SUFFIX  |                 | Q SUFFIX  |                 | M SUFFIX  |                 | UNIT |
|---------------------------------------|-----------|-----------------|-----------|-----------------|-----------|-----------------|-----------|-----------------|------|
|                                       | MIN       | MAX             | MIN       | MAX             | MIN       | MAX             | MIN       | MAX             |      |
| Supply voltage, $V_{DD}$              | 2.7       | 10              | 2.7       | 10              | 2.7       | 10              | 2.7       | 10              | V    |
| Input voltage range, $V_I$            | $V_{DD-}$ | $V_{DD+} - 0.8$ | $V_{DD-}$ | $V_{DD+} - 0.8$ | $V_{DD-}$ | $V_{DD+} - 0.8$ | $V_{DD-}$ | $V_{DD+} - 0.8$ | V    |
| Common-mode input voltage, $V_{IC}$   | $V_{DD-}$ | $V_{DD+} - 1.3$ | $V_{DD-}$ | $V_{DD+} - 1.3$ | $V_{DD-}$ | $V_{DD+} - 1.3$ | $V_{DD-}$ | $V_{DD+} - 1.3$ | V    |
| Operating free-air temperature, $T_A$ | 0         | 70              | -40       | 125             | -40       | 125             | -55       | 125             | °C   |



**TLV2432, TLV2432A, TLV2434, TLV2434A**  
**Advanced LinCMOS™ RAIL-TO-RAIL OUTPUT**  
**WIDE-INPUT-VOLTAGE OPERATIONAL AMPLIFIERS**

SLOS168F – NOVEMBER 1996 – REVISED MARCH 2001

**electrical characteristics at specified free-air temperature,  $V_{DD} = 3\text{ V}$  (unless otherwise noted)**

| PARAMETER  | TEST CONDITIONS   |                                   | $T_A^\dagger$ | TLV243x    |               |                              | UNIT |
|--|---|-----------------------------------|---------------|------------|---------------|------------------------------|------|
|  |   |                                   |               | MIN        | TYP           | MAX                          |      |
| $V_{IO}$ Input offset voltage  | $V_{IC} = 0,$<br>$V_O = 0,$<br>$V_{DD} \pm \pm 1.5\text{ V},$<br>$R_S = 50\ \Omega$ | TLV243xC,<br>TLV243xI             | 25°C          | 300        | 2000          | $\mu\text{V}$                |      |
|  |   |                                   | Full range    | 2500       |               |                              |      |
|  |   | TLV243xAI                         | 25°C          | 300        | 950           |                              |      |
|  |   |                                   | Full range    | 1500       |               |                              |      |
| $\alpha_{V_{IO}}$ Temperature coefficient of input offset voltage          | $V_{IC} = 0,$<br>$V_O = 0,$<br>$V_{DD} \pm \pm 1.5\text{ V},$<br>$R_S = 50\ \Omega$ |                                   | 25°C to 70°C  | 2          |               | $\mu\text{V}/^\circ\text{C}$ |      |
| Input offset voltage long-term drift (see Note 4)                          |   |                                   | 25°C          | 0.003      |               | $\mu\text{V}/\text{mo}$      |      |
| $I_{IO}$ Input offset current  |   |                                   | 25°C          | 0.5        | 60            | $\text{pA}$                  |      |
|  |   |                                   | Full range    | 150        |               |                              |      |
| $I_{IB}$ Input bias current  |   |                                   | 25°C          | 1          | 60            | $\text{pA}$                  |      |
|  |   |                                   | Full range    | 150        |               |                              |      |
| $V_{ICR}$ Common-mode input voltage range                                  | $ V_{IO}  \leq 5\text{ mV},$<br>$R_S = 50\ \Omega$                                  |                                   | 25°C          | 0 to 2.5   | -0.25 to 2.75 | $\text{V}$                   |      |
|  |   |                                   | Full range    | 0 to 2.2   |               |                              |      |
| $V_{OH}$ High-level output voltage   | $I_{OH} = -100\ \mu\text{A}$  |                                   | 25°C          | 2.98       |               | $\text{V}$                   |      |
|  |   |                                   | 25°C          | 2.5        |               |                              |      |
|  |   |                                   |               | Full range | 2.25          |                              |      |
| $V_{OL}$ Low-level output voltage  | $V_{IC} = 1.5\text{ V},$<br>$I_{OL} = 100\ \mu\text{A}$                             |                                   | 25°C          | 0.02       |               | $\text{V}$                   |      |
|  |   |                                   | 25°C          | 0.83       |               |                              |      |
|  | $V_{IC} = 1.5\text{ V},$<br>$I_{OL} = 3\text{ mA}$                                  | Full range                        | 1             |            |               |                              |      |
| $A_{VD}$ Large-signal differential voltage amplification                   | $V_{IC} = 2.5\text{ V},$<br>$V_O = 1\text{ V to }2\text{ V}$                        | $R_L = 2\text{ k}\Omega^\ddagger$ | 25°C          | 1.5        | 2.5           | $\text{V/mV}$                |      |
|  |   |                                   | Full range    | 1          |               |                              |      |
|  |   | $R_L = 1\text{ M}\Omega^\ddagger$ | 25°C          | 750        |               |                              |      |
| $r_{i(d)}$ Differential input resistance                                   |   |                                   | 25°C          | 1000       |               | $\text{G}\Omega$             |      |
| $r_{i(c)}$ Common-mode input resistance                                    |   |                                   | 25°C          | 1000       |               | $\text{G}\Omega$             |      |
| $c_{i(c)}$ Common-mode input capacitance                                   | $f = 10\text{ kHz}$   |                                   | 25°C          | 8          |               | $\text{pF}$                  |      |
| $z_o$ Closed-loop output impedance   | $f = 100\text{ kHz},$<br>$A_V = 10$   |                                   | 25°C          | 130        |               | $\Omega$                     |      |
| CMRR Common-mode rejection ratio   | $V_{IC} = 0\text{ to }2.5\text{ V},$<br>$V_O = 1.5\text{ V},$<br>$R_S = 50\ \Omega$ |                                   | 25°C          | 70         | 83            | $\text{dB}$                  |      |
|  |   |                                   | Full range    | 70         |               |                              |      |
| $k_{SVR}$ Supply-voltage rejection ratio ( $\Delta V_{DD}/\Delta V_{IO}$ ) | $V_{DD} = 2.7\text{ V to }8\text{ V},$<br>$V_{IC} = V_{DD}/2,$<br>No load           |                                   | 25°C          | 80         | 95            | $\text{dB}$                  |      |
|  |   |                                   | Full range    | 80         |               |                              |      |
| $I_{DD}$ Supply current (per channel)                                      | $V_O = 1.5\text{ V},$<br>No load  |                                   | 25°C          | 98         | 125           | $\mu\text{A}$                |      |
|  |   |                                   | Full range    | 125        |               |                              |      |

$^\dagger$  Full range for the C suffix is 0°C to 70°C. Full range for the dual I suffix is -40°C to 85°C. Full range for the quad I suffix is -40°C to 125°C.

$^\ddagger$  Referenced to 2.5 V

NOTE 4: Typical values are based on the input offset voltage shift observed through 500 hours of operating life test at  $T_A = 150^\circ\text{C}$  extrapolated to  $T_A = 25^\circ\text{C}$  using the Arrhenius equation and assuming an activation energy of 0.96 eV.

**TLV2432, TLV2432A, TLV2434, TLV2434A**  
**Advanced LinCMOS™ RAIL-TO-RAIL OUTPUT**  
**WIDE-INPUT-VOLTAGE OPERATIONAL AMPLIFIERS**

SLOS168F – NOVEMBER 1996 – REVISED MARCH 2001

**operating characteristics at specified free-air temperature,  $V_{DD} = 3\text{ V}$**

| PARAMETER   | TEST CONDITIONS   | $T_A$ †                               | TLV243x    |        |      | UNIT                   |
|---|---|---------------------------------------|------------|--------|------|------------------------|
|   |   |                                       | MIN        | TYP    | MAX  |                        |
| SR Slew rate at unity gain                              | $V_O = 1\text{ V to }2\text{ V}$ ,<br>$C_L = 100\text{ pF}‡$                                    | $R_L = 2\text{ k}\Omega‡$             | 25°C       | 0.15   | 0.25 | V/ $\mu\text{s}$       |
|   |   |                                       | Full range | 0.1    |      |                        |
| $V_n$ Equivalent input noise voltage                    | $f = 10\text{ Hz}$  |                                       | 25°C       | 120    |      | nV/ $\sqrt{\text{Hz}}$ |
|   | $f = 1\text{ kHz}$  |                                       | 25°C       | 22     |      |                        |
| $V_{N(PP)}$ Peak-to-peak equivalent input noise voltage | $f = 0.1\text{ Hz to }1\text{ Hz}$  |                                       | 25°C       | 2.7    |      | $\mu\text{V}$          |
|   | $f = 0.1\text{ Hz to }10\text{ Hz}$   |                                       | 25°C       | 4      |      |                        |
| $I_n$ Equivalent input noise current                    |   |                                       | 25°C       | 0.6    |      | fA/ $\sqrt{\text{Hz}}$ |
| THD + N Total harmonic distortion plus noise            | $V_O = 0.5\text{ V to }2.5\text{ V}$ ,<br>$f = 1\text{ kHz}$ ,<br>$R_L = 2\text{ k}\Omega‡$     | $A_V = 1$                             | 25°C       | 0.065% |      |                        |
|   |   | $A_V = 10$                            |            | 0.5%   |      |                        |
| Gain-bandwidth product                                  | $f = 10\text{ kHz}$ ,<br>$C_L = 100\text{ pF}‡$   | $R_L = 2\text{ k}\Omega‡$             | 25°C       | 0.5    |      | MHz                    |
| BOM Maximum output-swing bandwidth                      | $V_{O(PP)} = 1\text{ V}$ ,<br>$R_L = 2\text{ k}\Omega‡$   | $A_V = 1$ ,<br>$C_L = 100\text{ pF}‡$ | 25°C       | 220    |      | kHz                    |
| $t_s$ Settling time                                     | $A_V = -1$ ,<br>Step = 0.5 V to 2.5 V,<br>$R_L = 2\text{ k}\Omega‡$ ,<br>$C_L = 100\text{ pF}‡$ | To 0.1%                               | 25°C       | 6.4    |      | $\mu\text{s}$          |
|   |   | To 0.01%                              |            | 14.1   |      |                        |
| $\phi_m$ Phase margin at unity gain                     | $R_L = 2\text{ k}\Omega‡$   | $C_L = 100\text{ pF}‡$                | 25°C       | 62°    |      |                        |
| Gain margin   |   |                                       | 25°C       | 11     |      |                        |

† Full range for the C suffix is 0°C to 70°C. Full range for the dual I suffix is –40°C to 85°C. Full range for the quad I suffix is –40°C to 125°C.

‡ Referenced to 2.5 V



**TLV2432, TLV2432A, TLV2434, TLV2434A**  
**Advanced LinCMOS™ RAIL-TO-RAIL OUTPUT**  
**WIDE-INPUT-VOLTAGE OPERATIONAL AMPLIFIERS**

SLOS168F – NOVEMBER 1996 – REVISED MARCH 2001

**electrical characteristics at specified free-air temperature,  $V_{DD} = 3\text{ V}$  (unless otherwise noted)**

| PARAMETER  | TEST CONDITIONS   |                                   | $T_A$ †         | TLV243xQ,<br>TLV243xM |               |                              | UNIT |
|--|---|-----------------------------------|-----------------|-----------------------|---------------|------------------------------|------|
|  |   |                                   |                 | MIN                   | TYP           | MAX                          |      |
| $V_{IO}$ Input offset voltage  | $V_{IC} = 0,$<br>$V_O = 0,$<br>$V_{DD} \pm \pm 1.5\text{ V},$<br>$R_S = 50\ \Omega$ | TLV243xQ,<br>TLV243xM             | 25°C            | 300                   | 2000          | $\mu\text{V}$                |      |
|  |   |                                   | Full range      | 2500                  |               |                              |      |
|  |   | TLV243xAQ,<br>TLV243xAM           | 25°C            | 300                   | 950           |                              |      |
|  |   |                                   | Full range      | 2000                  |               |                              |      |
| $\alpha_{V_{IO}}$ Temperature coefficient of input offset voltage          | $V_{IC} = 0,$<br>$V_O = 0,$<br>$V_{DD} \pm \pm 1.5\text{ V},$<br>$R_S = 50\ \Omega$ |                                   | 25°C<br>to 70°C | 2                     |               | $\mu\text{V}/^\circ\text{C}$ |      |
| Input offset voltage long-term drift<br>(see Note 4)                       |   |                                   | 25°C            | 0.003                 |               | $\mu\text{V}/\text{mo}$      |      |
| $I_{IO}$ Input offset current  |   |                                   | 25°C            | 0.5                   | 60            | $\text{pA}$                  |      |
|  |   |                                   | Full range      | 150                   |               |                              |      |
| $I_{IB}$ Input bias current  |   |                                   | 25°C            | 1                     | 60            | $\text{pA}$                  |      |
|  |   |                                   | Full range      | 300                   |               |                              |      |
| $V_{ICR}$ Common-mode input voltage range                                  | $ V_{IO}  \leq 5\text{ mV},$<br>$R_S = 50\ \Omega$                                  |                                   | 25°C            | 0 to 2.5              | -0.25 to 2.75 | V                            |      |
|  |   |                                   | Full range      | 0 to 2.2              |               |                              |      |
| $V_{OH}$ High-level output voltage   | $I_{OH} = -100\ \mu\text{A}$  |                                   | 25°C            | 2.98                  |               | V                            |      |
|  |   |                                   | 25°C            | 2.5                   |               |                              |      |
|  |   |                                   | Full range      | 2.25                  |               |                              |      |
| $V_{OL}$ Low-level output voltage  | $V_{IC} = 1.5\text{ V},$<br>$I_{OL} = 100\ \mu\text{A}$                             |                                   | 25°C            | 0.02                  |               | V                            |      |
|  |   |                                   | 25°C            | 0.83                  |               |                              |      |
|  | $V_{IC} = 1.5\text{ V},$<br>$I_{OL} = 3\text{ mA}$                                  | Full range                        | 1               |                       |               |                              |      |
| $A_{VD}$ Large-signal differential voltage amplification                   | $V_{IC} = 2.5\text{ V},$<br>$V_O = 1\text{ V to }2\text{ V}$                        | $R_L = 2\text{ k}\Omega^\ddagger$ | 25°C            | 1.5                   | 2.5           | V/mV                         |      |
|  |   |                                   | Full range      | 0.5                   |               |                              |      |
|  |   | $R_L = 1\text{ M}\Omega^\ddagger$ | 25°C            | 750                   |               |                              |      |
| $r_{i(d)}$ Differential input resistance                                   |   |                                   | 25°C            | 1000                  |               | $\text{G}\Omega$             |      |
| $r_{i(c)}$ Common-mode input resistance                                    |   |                                   | 25°C            | 1000                  |               | $\text{G}\Omega$             |      |
| $c_{i(c)}$ Common-mode input capacitance                                   | $f = 10\text{ kHz}$   |                                   | 25°C            | 8                     |               | $\text{pF}$                  |      |
| $z_o$ Closed-loop output impedance   | $f = 100\text{ kHz},$<br>$A_V = 10$   |                                   | 25°C            | 130                   |               | $\Omega$                     |      |
| CMRR Common-mode rejection ratio   | $V_{IC} = 0\text{ to }2.5\text{ V},$<br>$V_O = 1.5\text{ V},$<br>$R_S = 50\ \Omega$ |                                   | 25°C            | 70                    | 83            | dB                           |      |
|  |   |                                   | Full range      | 70                    |               |                              |      |
| $k_{SVR}$ Supply-voltage rejection ratio ( $\Delta V_{DD}/\Delta V_{IO}$ ) | $V_{DD} = 2.7\text{ V to }8\text{ V},$<br>$V_{IC} = V_{DD}/2,$<br>No load           |                                   | 25°C            | 80                    | 95            | dB                           |      |
|  |   |                                   | Full range      | 80                    |               |                              |      |
| $I_{DD}$ Supply current  | $V_O = 1.5\text{ V},$<br>No load  |                                   | 25°C            | 195                   | 250           | $\mu\text{A}$                |      |
|  |   |                                   | Full range      | 260                   |               |                              |      |

† Full range is  $-40^\circ\text{C}$  to  $125^\circ\text{C}$  for Q level part,  $-55^\circ\text{C}$  to  $125^\circ\text{C}$  for M level part.

‡ Referenced to 2.5 V

NOTE 4: Typical values are based on the input offset voltage shift observed through 500 hours of operating life test at  $T_A = 150^\circ\text{C}$  extrapolated to  $T_A = 25^\circ\text{C}$  using the Arrhenius equation and assuming an activation energy of 0.96 eV.

**TLV2432, TLV2432A, TLV2434, TLV2434A**  
**Advanced LinCMOS™ RAIL-TO-RAIL OUTPUT**  
**WIDE-INPUT-VOLTAGE OPERATIONAL AMPLIFIERS**

SLOS168F – NOVEMBER 1996 – REVISED MARCH 2001

**operating characteristics at specified free-air temperature,  $V_{DD} = 3\text{ V}$**

| PARAMETER  | TEST CONDITIONS   | $T_A$ †    | TLV243xQ,<br>TLV243xM,<br>TLV243xAQ,<br>TLV243xAM |        |                        | UNIT             |
|--|---|------------|---|--------|------------------------|------------------|
|  |   |            | MIN   | TYP    | MAX                    |                  |
| SR Slew rate at unity gain                                   | $V_O = 1\text{ V to }2\text{ V},$<br>$C_L = 100\text{ pF}‡$<br>$R_L = 2\text{ k}\Omega‡$            | 25°C       | 0.15  | 0.25   |                        | V/ $\mu\text{s}$ |
|  |   | Full range | 0.1   |        |                        |                  |
| $V_n$ Equivalent input noise voltage                         | $f = 10\text{ Hz}$  | 25°C       | 120   |        | nV/ $\sqrt{\text{Hz}}$ |                  |
|  | $f = 1\text{ kHz}$  | 25°C       | 22  |        |                        |                  |
| $V_N(\text{PP})$ Peak-to-peak equivalent input noise voltage | $f = 0.1\text{ Hz to }1\text{ Hz}$  | 25°C       | 2.7   |        | $\mu\text{V}$          |                  |
|  | $f = 0.1\text{ Hz to }10\text{ Hz}$   | 25°C       | 4   |        |                        |                  |
| $I_n$ Equivalent input noise current                         |   | 25°C       | 0.6   |        | fA/ $\sqrt{\text{Hz}}$ |                  |
| THD + N Total harmonic distortion plus noise                 | $V_O = 0.5\text{ V to }2.5\text{ V},$<br>$f = 1\text{ kHz},$<br>$R_L = 2\text{ k}\Omega‡$           | 25°C       | $A_V = 1$   | 0.065% |                        |                  |
|  |   |            | $A_V = 10$  | 0.5%   |                        |                  |
| Gain-bandwidth product                                       | $f = 10\text{ kHz},$<br>$C_L = 100\text{ pF}‡$<br>$R_L = 2\text{ k}\Omega‡$                         | 25°C       | 0.5   |        | MHz                    |                  |
| BOM Maximum output-swing bandwidth                           | $V_O(\text{PP}) = 1\text{ V},$<br>$R_L = 2\text{ k}\Omega‡$<br>$A_V = 1,$<br>$C_L = 100\text{ pF}‡$ | 25°C       | 220   |        | kHz                    |                  |
| $t_s$ Settling time  | $A_V = -1,$<br>Step = 0.5 V to 2.5 V,<br>$R_L = 2\text{ k}\Omega‡$<br>$C_L = 100\text{ pF}‡$        | 25°C       | To 0.1%   | 6.4    |                        | $\mu\text{s}$    |
|  |   |            | To 0.01%  | 14.1   |                        |                  |
| $\phi_m$ Phase margin at unity gain                          | $R_L = 2\text{ k}\Omega‡$<br>$C_L = 100\text{ pF}‡$   | 25°C       | 62°   |        |                        |                  |
| Gain margin  |   | 25°C       | 11  |        | dB                     |                  |

† Full range is -40°C to 125°C for Q level part, -55°C to 125°C for M level part.

‡ Referenced to 2.5 V



**TLV2432, TLV2432A, TLV2434, TLV2434A**  
**Advanced LinCMOS™ RAIL-TO-RAIL OUTPUT**  
**WIDE-INPUT-VOLTAGE OPERATIONAL AMPLIFIERS**

SLOS168F – NOVEMBER 1996 – REVISED MARCH 2001

**electrical characteristics at specified free-air temperature,  $V_{DD} = 5\text{ V}$  (unless otherwise noted)**

| PARAMETER  | TEST CONDITIONS   |                                   | $T_A^\dagger$ | TLV243x  |               |                              | UNIT |
|--|---|-----------------------------------|---------------|----------|---------------|------------------------------|------|
|  |   |                                   |               | MIN      | TYP           | MAX                          |      |
| $V_{IO}$ Input offset voltage  | $V_{IC} = 0,$<br>$V_O = 0,$<br>$V_{DD} \pm \pm 2.5\text{ V},$<br>$R_S = 50\ \Omega$ | TLV243x                           | 25°C          | 300      | 2000          | $\mu\text{V}$                |      |
|  |   |                                   | Full range    | 2500     |               |                              |      |
|  |   | TLV243xA                          | 25°C          | 300      | 950           |                              |      |
|  |   |                                   | Full range    | 1500     |               |                              |      |
| $\alpha_{V_{IO}}$ Temperature coefficient of input offset voltage          | $V_{IC} = 0,$<br>$V_O = 0,$<br>$V_{DD} \pm \pm 2.5\text{ V},$<br>$R_S = 50\ \Omega$ |                                   | 25°C to 70°C  | 2        |               | $\mu\text{V}/^\circ\text{C}$ |      |
| Input offset voltage long-term drift (see Note 4)                          |   |                                   | 25°C          | 0.003    |               | $\mu\text{V}/\text{mo}$      |      |
| $I_{IO}$ Input offset current  |   |                                   | 25°C          | 0.5      | 60            | $\text{pA}$                  |      |
|  |   |                                   | Full range    | 150      |               |                              |      |
| $I_{IB}$ Input bias current  |   |                                   | 25°C          | 1        | 60            | $\text{pA}$                  |      |
|  |   |                                   | Full range    | 150      |               |                              |      |
| $V_{ICR}$ Common-mode input voltage range                                  | $ V_{IO}  \leq 5\text{ mV},$<br>$R_S = 50\ \Omega$                                  |                                   | 25°C          | 0 to 4.5 | -0.25 to 4.75 | $\text{V}$                   |      |
|  |   |                                   | Full range    | 0 to 4.2 |               |                              |      |
| $V_{OH}$ High-level output voltage   | $I_{OH} = -100\ \mu\text{A}$  |                                   | 25°C          | 4.97     |               | $\text{V}$                   |      |
|  |   |                                   | Full range    | 25°C     | 4             |                              | 4.35 |
|  |   |                                   |               | 4        |               |                              |      |
| $V_{OL}$ Low-level output voltage  | $V_{IC} = 2.5\text{ V},$<br>$I_{OL} = 100\ \mu\text{A}$                             |                                   | 25°C          | 0.01     |               | $\text{V}$                   |      |
|  |   |                                   | Full range    | 25°C     | 0.8           |                              |      |
|  | $V_{IC} = 2.5\text{ V},$<br>$I_{OL} = 5\text{ mA}$                                  |                                   |               | 1.25     |               |                              |      |
| $A_{VD}$ Large-signal differential voltage amplification                   | $V_{IC} = 2.5\text{ V},$<br>$V_O = 1\text{ V to }4\text{ V}$                        | $R_L = 2\text{ k}\Omega^\ddagger$ | 25°C          | 2.5      | 3.8           | $\text{V/mV}$                |      |
|  |   |                                   | Full range    | 1.5      |               |                              |      |
|  |   | $R_L = 1\text{ M}\Omega^\ddagger$ | 25°C          | 950      |               |                              |      |
| $r_{i(d)}$ Differential input resistance                                   |   |                                   | 25°C          | 1000     |               | $\text{G}\Omega$             |      |
| $r_{i(c)}$ Common-mode input resistance                                    |   |                                   | 25°C          | 1000     |               | $\text{G}\Omega$             |      |
| $c_{i(c)}$ Common-mode input capacitance                                   | $f = 10\text{ kHz}$   |                                   | 25°C          | 8        |               | $\text{pF}$                  |      |
| $z_o$ Closed-loop output impedance   | $f = 100\text{ kHz},$<br>$A_V = 10$   |                                   | 25°C          | 130      |               | $\Omega$                     |      |
| CMRR Common-mode rejection ratio   | $V_{IC} = 0\text{ to }4.5\text{ V},$<br>$V_O = 2.5\text{ V},$<br>$R_S = 50\ \Omega$ |                                   | 25°C          | 70       | 90            | $\text{dB}$                  |      |
|  |   |                                   | Full range    | 70       |               |                              |      |
| $k_{SVR}$ Supply-voltage rejection ratio ( $\Delta V_{DD}/\Delta V_{IO}$ ) | $V_{DD} = 4.4\text{ V to }8\text{ V},$<br>$V_{IC} = V_{DD}/2,$<br>No load           |                                   | 25°C          | 80       | 95            | $\text{dB}$                  |      |
|  |   |                                   | Full range    | 80       |               |                              |      |
| $I_{DD}$ Supply current (per channel)                                      | $V_O = 2.5\text{ V},$<br>No load  |                                   | 25°C          | 100      | 125           | $\mu\text{A}$                |      |
|  |   |                                   | Full range    | 125      |               |                              |      |

$^\dagger$  Full range for the C suffix is 0°C to 70°C. Full range for the dual I suffix is -40°C to 85°C. Full range for the quad I suffix is -40°C to 125°C.

$^\ddagger$  Referenced to 2.5 V

NOTE 4: Typical values are based on the input offset voltage shift observed through 500 hours of operating life test at  $T_A = 150^\circ\text{C}$  extrapolated to  $T_A = 25^\circ\text{C}$  using the Arrhenius equation and assuming an activation energy of 0.96 eV.

**TLV2432, TLV2432A, TLV2434, TLV2434A**  
**Advanced LinCMOS™ RAIL-TO-RAIL OUTPUT**  
**WIDE-INPUT-VOLTAGE OPERATIONAL AMPLIFIERS**

SLOS168F – NOVEMBER 1996 – REVISED MARCH 2001

**operating characteristics at specified free-air temperature,  $V_{DD} = 5\text{ V}$**

| PARAMETER   | TEST CONDITIONS  | $T_A$ †        | TLV243x |      |                        | UNIT             |
|---|--|----------------|---------|------|------------------------|------------------|
|   |  |                | MIN     | TYP  | MAX                    |                  |
| SR Slew rate at unity gain                              | $V_O = 1.5\text{ V to }3.5\text{ V}, R_L = 2\text{ k}\Omega\ddagger, C_L = 100\text{ pF}\ddagger$                    | 25°C           | 0.15    | 0.25 |                        | V/ $\mu\text{s}$ |
|   |  | Full range     | 0.1     |      |                        |                  |
| $V_n$ Equivalent input noise voltage                    | $f = 10\text{ Hz}$   | 25°C           | 100     |      | nV/ $\sqrt{\text{Hz}}$ |                  |
|   | $f = 1\text{ kHz}$   | 25°C           | 18      |      |                        |                  |
| $V_{N(PP)}$ Peak-to-peak equivalent input noise voltage | $f = 0.1\text{ Hz to }1\text{ Hz}$   | 25°C           | 1.9     |      | $\mu\text{V}$          |                  |
|   | $f = 0.1\text{ Hz to }10\text{ Hz}$  | 25°C           | 2.8     |      |                        |                  |
| $I_n$ Equivalent input noise current                    |  | 25°C           | 0.6     |      | fA/ $\sqrt{\text{Hz}}$ |                  |
| THD + N Total harmonic distortion plus noise            | $V_O = 1.5\text{ V to }3.5\text{ V}, f = 1\text{ kHz}, R_L = 2\text{ k}\Omega\ddagger$                               | $A_V = 1$      | 0.045%  |      |                        |                  |
|   |  | $A_V = 10$     | 0.4%    |      |                        |                  |
| Gain-bandwidth product                                  | $f = 10\text{ kHz}, R_L = 2\text{ k}\Omega\ddagger, C_L = 100\text{ pF}\ddagger$                                     | 25°C           | 0.55    |      | MHz                    |                  |
| BOM Maximum output-swing bandwidth                      | $V_{O(PP)} = 2\text{ V}, R_L = 2\text{ k}\Omega\ddagger, A_V = 1, C_L = 100\text{ pF}\ddagger$                       | 25°C           | 100     |      | kHz                    |                  |
| $t_s$ Settling time                                     | $A_V = -1, \text{ Step} = 1.5\text{ V to }3.5\text{ V}, R_L = 2\text{ k}\Omega\ddagger, C_L = 100\text{ pF}\ddagger$ | $T_o = 0.1\%$  | 6.4     |      | $\mu\text{s}$          |                  |
|   |  | $T_o = 0.01\%$ | 13.1    |      |                        |                  |
| $\phi_m$ Phase margin at unity gain                     | $R_L = 2\text{ k}\Omega\ddagger, C_L = 100\text{ pF}\ddagger$  | 25°C           | 66°     |      |                        |                  |
| Gain margin   |  | 25°C           | 11      |      | dB                     |                  |

† Full range for the C suffix is 0°C to 70°C. Full range for the dual I suffix is –40°C to 85°C. Full range for the quad I suffix is –40°C to 125°C.

‡ Referenced to 2.5 V



# TLV2432, TLV2432A, TLV2434, TLV2434A Advanced LinCMOS™ RAIL-TO-RAIL OUTPUT WIDE-INPUT-VOLTAGE OPERATIONAL AMPLIFIERS

SLOS168F – NOVEMBER 1996 – REVISED MARCH 2001

**electrical characteristics at specified free-air temperature,  $V_{DD} = 5\text{ V}$  (unless otherwise noted)**

| PARAMETER  | TEST CONDITIONS   |                                   | $T_A$ †      | TLV243xQ,<br>TLV243xM |               |                              | UNIT |
|--|---|-----------------------------------|--------------|-----------------------|---------------|------------------------------|------|
|  |   |                                   |              | MIN                   | TYP           | MAX                          |      |
| $V_{IO}$ Input offset voltage  | $V_{IC} = 0,$<br>$V_O = 0,$<br>$V_{DD} \pm = \pm 2.5\text{ V},$<br>$R_S = 50\ \Omega$ | TLV2453x                          | 25°C         | 300                   | 2000          | $\mu\text{V}$                |      |
|  |   |                                   | Full range   | 2500                  |               |                              |      |
|  |   | TLV2453xA                         | 25°C         | 300                   | 950           |                              |      |
|  |   |                                   | Full range   | 2000                  |               |                              |      |
| $\alpha_{V_{IO}}$ Temperature coefficient of input offset voltage          | $V_{IC} = 0,$<br>$V_O = 0,$<br>$V_{DD} \pm = \pm 2.5\text{ V},$<br>$R_S = 50\ \Omega$ |                                   | 25°C to 70°C | 2                     |               | $\mu\text{V}/^\circ\text{C}$ |      |
| Input offset voltage long-term drift (see Note 4)                          |   |                                   | 25°C         | 0.003                 |               | $\mu\text{V}/\text{mo}$      |      |
| $I_{IO}$ Input offset current  |   |                                   | 25°C         | 0.5                   | 60            | $\text{pA}$                  |      |
|  |   |                                   | Full range   | 150                   |               |                              |      |
| $I_{IB}$ Input bias current  |   |                                   | 25°C         | 1                     | 60            | $\text{pA}$                  |      |
|  |   |                                   | Full range   | 300                   |               |                              |      |
| $V_{ICR}$ Common-mode input voltage range                                  | $ V_{IO}  \leq 5\text{ mV},$<br>$R_S = 50\ \Omega$                                    |                                   | 25°C         | 0 to 4.5              | -0.25 to 4.75 | V                            |      |
|  |   |                                   | Full range   | 0 to 4.2              |               |                              |      |
| $V_{OH}$ High-level output voltage   | $I_{OH} = -100\ \mu\text{A}$  |                                   | 25°C         | 4.97                  |               | V                            |      |
|  |   |                                   | 25°C         | 4                     | 4.35          |                              |      |
|  |   |                                   | Full range   | 4                     |               |                              |      |
| $V_{OL}$ Low-level output voltage  | $V_{IC} = 2.5\text{ V},$<br>$I_{OL} = 100\ \mu\text{A}$                               |                                   | 25°C         | 0.01                  |               | V                            |      |
|  |   |                                   | 25°C         | 0.8                   |               |                              |      |
|  | $V_{IC} = 2.5\text{ V},$<br>$I_{OL} = 5\text{ mA}$                                    |                                   | Full range   | 1.25                  |               |                              |      |
| $A_{VD}$ Large-signal differential voltage amplification                   | $V_{IC} = 2.5\text{ V},$<br>$V_O = 1\text{ V to }4\text{ V}$                          | $R_L = 2\text{ k}\Omega^\ddagger$ | 25°C         | 2.5                   | 3.8           | V/mV                         |      |
|  |   | $R_L = 1\text{ M}\Omega^\ddagger$ | Full range   | 0.5                   |               |                              |      |
|  |   |                                   | 25°C         | 950                   |               |                              |      |
| $r_{i(d)}$ Differential input resistance                                   |   |                                   | 25°C         | 1000                  |               | $\text{G}\Omega$             |      |
| $r_{i(c)}$ Common-mode input resistance                                    |   |                                   | 25°C         | 1000                  |               | $\text{G}\Omega$             |      |
| $c_{i(c)}$ Common-mode input capacitance                                   | $f = 10\text{ kHz}$   |                                   | 25°C         | 8                     |               | $\text{pF}$                  |      |
| $z_o$ Closed-loop output impedance   | $f = 100\text{ kHz},$<br>$A_V = 10$   |                                   | 25°C         | 130                   |               | $\Omega$                     |      |
| CMRR Common-mode rejection ratio   | $V_{IC} = 0\text{ to }4.5\text{ V},$<br>$V_O = 2.5\text{ V},$<br>$R_S = 50\ \Omega$   |                                   | 25°C         | 70                    | 90            | dB                           |      |
|  |   |                                   | Full range   | 70                    |               |                              |      |
| $k_{SVR}$ Supply-voltage rejection ratio ( $\Delta V_{DD}/\Delta V_{IO}$ ) | $V_{DD} = 4.4\text{ V to }8\text{ V},$<br>$V_{IC} = V_{DD}/2,$<br>No load             |                                   | 25°C         | 80                    | 95            | dB                           |      |
|  |   |                                   | Full range   | 80                    |               |                              |      |
| $I_{DD}$ Supply current  | $V_O = 2.5\text{ V},$<br>No load  |                                   | 25°C         | 200                   | 250           | $\mu\text{A}$                |      |
|  |   |                                   | Full range   | 270                   |               |                              |      |

† Full range is  $-40^\circ\text{C}$  to  $125^\circ\text{C}$  for Q level part,  $-55^\circ\text{C}$  to  $125^\circ\text{C}$  for M level part.

‡ Referenced to 2.5 V

NOTE 4: Typical values are based on the input offset voltage shift observed through 500 hours of operating life test at  $T_A = 150^\circ\text{C}$  extrapolated to  $T_A = 25^\circ\text{C}$  using the Arrhenius equation and assuming an activation energy of 0.96 eV.

**TLV2432, TLV2432A, TLV2434, TLV2434A**  
**Advanced LinCMOS™ RAIL-TO-RAIL OUTPUT**  
**WIDE-INPUT-VOLTAGE OPERATIONAL AMPLIFIERS**

SLOS168F – NOVEMBER 1996 – REVISED MARCH 2001

**operating characteristics at specified free-air temperature,  $V_{DD} = 5\text{ V}$**

| PARAMETER   | TEST CONDITIONS  | $T_A$ †    | TLV243xQ,<br>TLV243xM,<br>TLV243xAQ,<br>TLV243xAM |      |                        | UNIT       |
|---|--|------------|---|------|------------------------|------------|
|   |  |            | MIN   | TYP  | MAX                    |            |
| SR Slew rate at unity gain                              | $V_O = 1.5\text{ V to }3.5\text{ V}, R_L = 2\text{ k}\Omega\ddagger, C_L = 100\text{ pF}\ddagger$                    | 25°C       | 0.15  | 0.25 |                        | V/ $\mu$ s |
|   |  | Full range | 0.1   |      |                        |            |
| $V_n$ Equivalent input noise voltage                    | $f = 10\text{ Hz}$   | 25°C       | 100   |      | nV/ $\sqrt{\text{Hz}}$ |            |
|   | $f = 1\text{ kHz}$   | 25°C       | 18  |      |                        |            |
| $V_{N(PP)}$ Peak-to-peak equivalent input noise voltage | $f = 0.1\text{ Hz to }1\text{ Hz}$   | 25°C       | 1.9   |      | $\mu$ V                |            |
|   | $f = 0.1\text{ Hz to }10\text{ Hz}$  | 25°C       | 2.8   |      |                        |            |
| $I_n$ Equivalent input noise current                    |  | 25°C       | 0.6   |      | fA/ $\sqrt{\text{Hz}}$ |            |
| THD + N Total harmonic distortion plus noise            | $V_O = 1.5\text{ V to }3.5\text{ V}, f = 1\text{ kHz}, R_L = 2\text{ k}\Omega\ddagger$                               | $A_V = 1$  | 0.045%  |      |                        |            |
|   |  | $A_V = 10$ | 0.4%  |      |                        |            |
| Gain-bandwidth product                                  | $f = 10\text{ kHz}, C_L = 100\text{ pF}\ddagger, R_L = 2\text{ k}\Omega\ddagger$                                     | 25°C       | 0.55  |      | MHz                    |            |
| BOM Maximum output-swing bandwidth                      | $V_{O(PP)} = 2\text{ V}, R_L = 2\text{ k}\Omega\ddagger, A_V = 1, C_L = 100\text{ pF}\ddagger$                       | 25°C       | 100   |      | kHz                    |            |
| $t_s$ Settling time                                     | $A_V = -1, \text{ Step} = 1.5\text{ V to }3.5\text{ V}, R_L = 2\text{ k}\Omega\ddagger, C_L = 100\text{ pF}\ddagger$ | To 0.1%    | 6.4   |      | $\mu$ s                |            |
|   |  | To 0.01%   | 13.1  |      |                        |            |
| $\phi_m$ Phase margin at unity gain                     | $R_L = 2\text{ k}\Omega\ddagger, C_L = 100\text{ pF}\ddagger$  | 25°C       | 66°   |      |                        |            |
| Gain margin   |  | 25°C       | 11  |      | dB                     |            |

† Full range is  $-40^\circ\text{C}$  to  $125^\circ\text{C}$  for Q level part,  $-55^\circ\text{C}$  to  $125^\circ\text{C}$  for M level part.

‡ Referenced to 2.5 V



**TLV2432, TLV2432A, TLV2434, TLV2434A**  
**Advanced LinCMOS™ RAIL-TO-RAIL OUTPUT**  
**WIDE-INPUT-VOLTAGE OPERATIONAL AMPLIFIERS**

SLOS168F – NOVEMBER 1996 – REVISED MARCH 2001

**TYPICAL CHARACTERISTICS**

**Table of Graphs**

|                 |   |  | <b>FIGURE</b> |
|-----------------|---|--|---------------|
| $V_{IO}$        | Input offset voltage                            | Distribution<br>vs Common-mode input voltage   | 2,3<br>4,5    |
| $\alpha_{VIO}$  | Temperature coefficient                         | Distribution                                   | 6,7           |
| $I_{IB}/I_{IO}$ | Input bias and input offset currents            | vs Free-air temperature                        | 8             |
| $V_{OH}$        | High-level output voltage                       | vs High-level output current                   | 9,11          |
| $V_{OL}$        | Low-level output voltage                        | vs Low-level output current                    | 10,12         |
| $V_{O(PP)}$     | Maximum peak-to-peak output voltage             | vs Frequency                                   | 13            |
| $I_{OS}$        | Short-circuit output current                    | vs Supply voltage<br>vs Free-air temperature   | 14<br>15      |
| $V_{ID}$        | Differential input voltage                      | vs Output voltage                              | 16,17         |
|                 | Differential gain                               | vs Load resistance                             | 18            |
| $A_{VD}$        | Large-signal differential voltage amplification | vs Frequency                                   | 19,20         |
| $A_{VD}$        | Differential voltage amplification              | vs Free-air temperature                        | 21,22         |
| $z_o$           | Output impedance                                | vs Frequency                                   | 23,24         |
| $CMRR$          | Common-mode rejection ratio                     | vs Frequency<br>vs Free-air temperature        | 25<br>26      |
| $k_{SVR}$       | Supply-voltage rejection ratio                  | vs Frequency<br>vs Free-air temperature        | 27,28<br>29   |
| $I_{DD}$        | Supply current                                  | vs Supply voltage                              | 30            |
| $SR$            | Slew rate                                       | vs Load capacitance<br>vs Free-air temperature | 31<br>32      |
| $V_O$           | Inverting large-signal pulse response           |  | 33,34         |
| $V_O$           | Voltage-follower large-signal pulse response    |  | 35,36         |
| $V_O$           | Inverting small-signal pulse response           |  | 37,38         |
| $V_O$           | Voltage-follower small-signal pulse response    |  | 39,40         |
| $V_n$           | Equivalent input noise voltage                  | vs Frequency                                   | 41, 42        |
|                 | Noise voltage (referred to input)               | Over a 10-second period                        | 43            |
| $THD + N$       | Total harmonic distortion plus noise            | vs Frequency                                   | 44,45         |
|                 | Gain-bandwidth product                          | vs Free-air temperature<br>vs Supply voltage   | 46<br>47      |
| $\phi_m$        | Phase margin                                    | vs Frequency<br>vs Load capacitance            | 19,20<br>48   |
|                 | Gain margin                                     | vs Load capacitance                            | 49            |
| $B_1$           | Unity-gain bandwidth                            | vs Load capacitance                            | 50            |

**TLV2432, TLV2432A, TLV2434, TLV2434A**  
**Advanced LinCMOS™ RAIL-TO-RAIL OUTPUT**  
**WIDE-INPUT-VOLTAGE OPERATIONAL AMPLIFIERS**

SLOS168F – NOVEMBER 1996 – REVISED MARCH 2001

**TYPICAL CHARACTERISTICS**

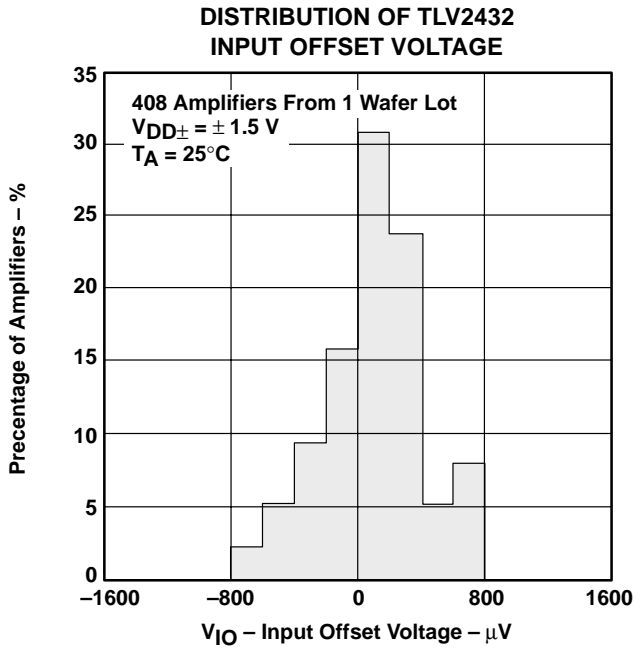

**Figure 2**

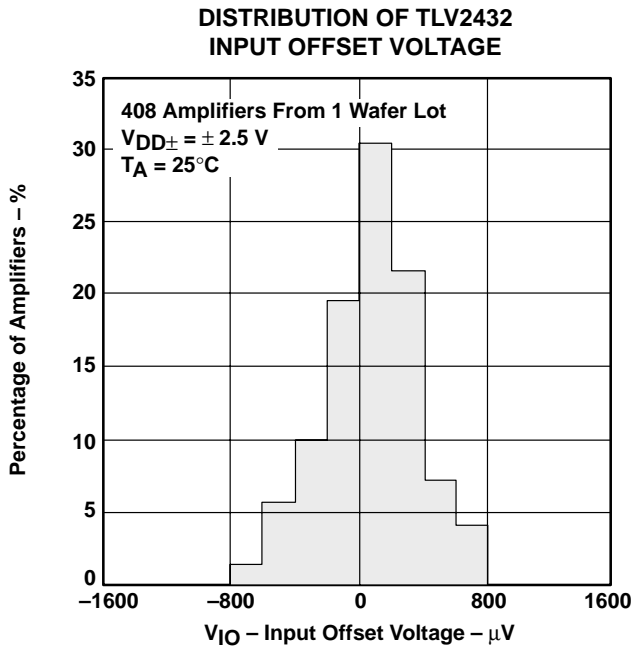

**Figure 3**

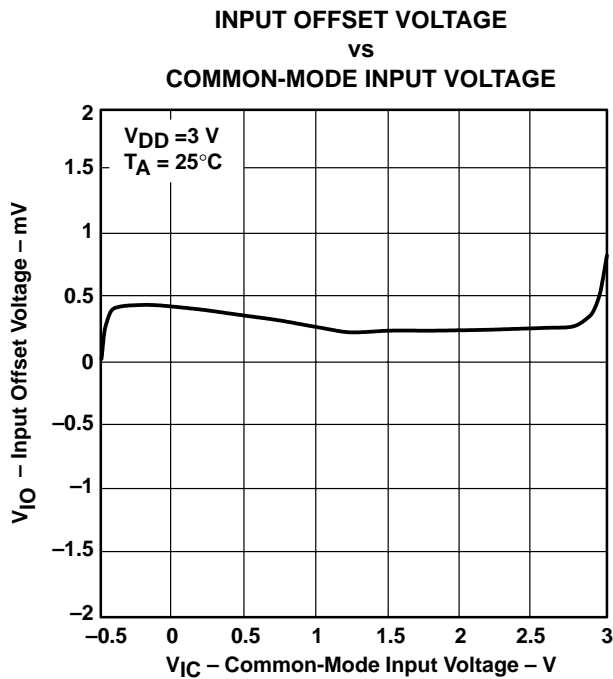

**Figure 4**

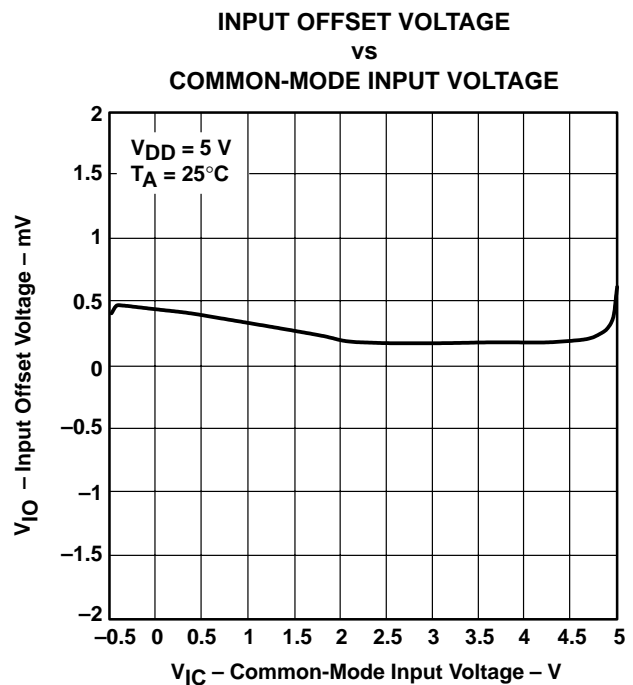

**Figure 5**



TYPICAL CHARACTERISTICS

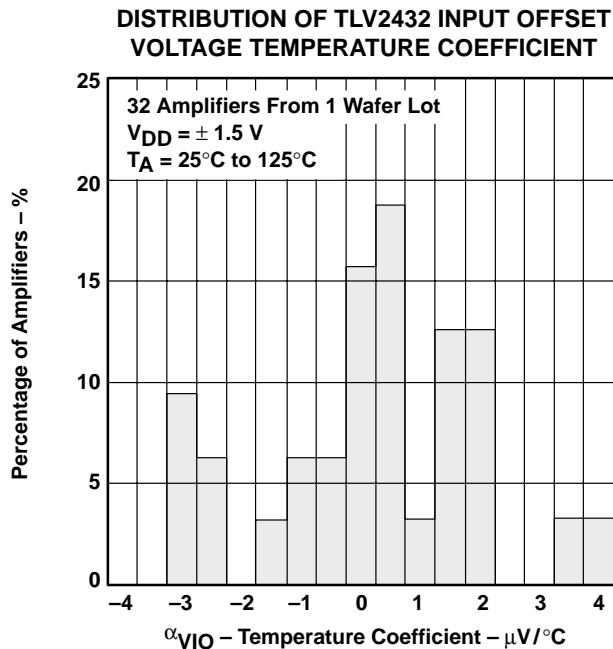

Figure 6

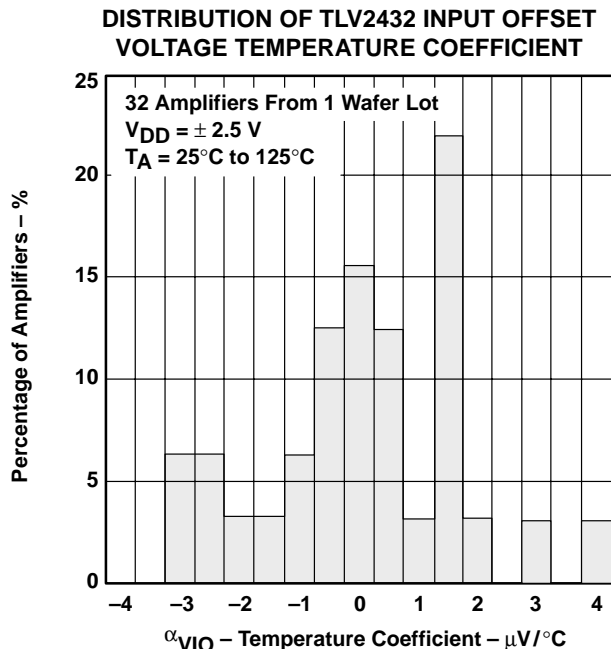

Figure 7

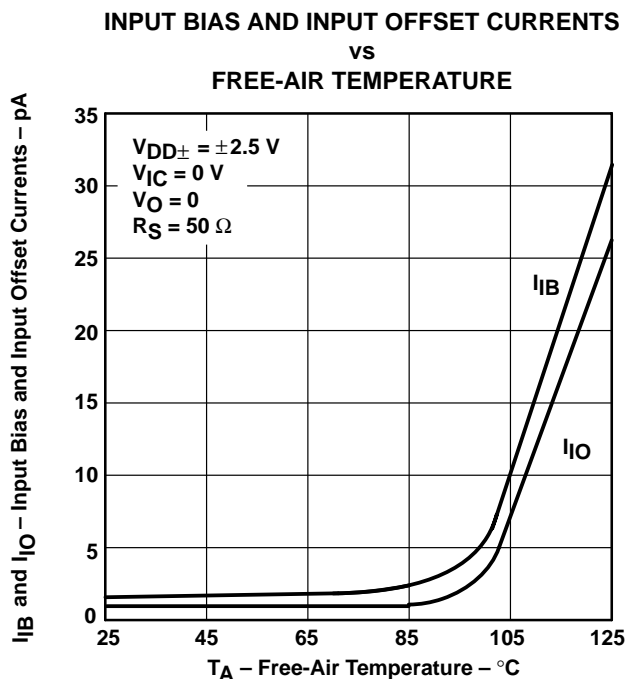

Figure 8

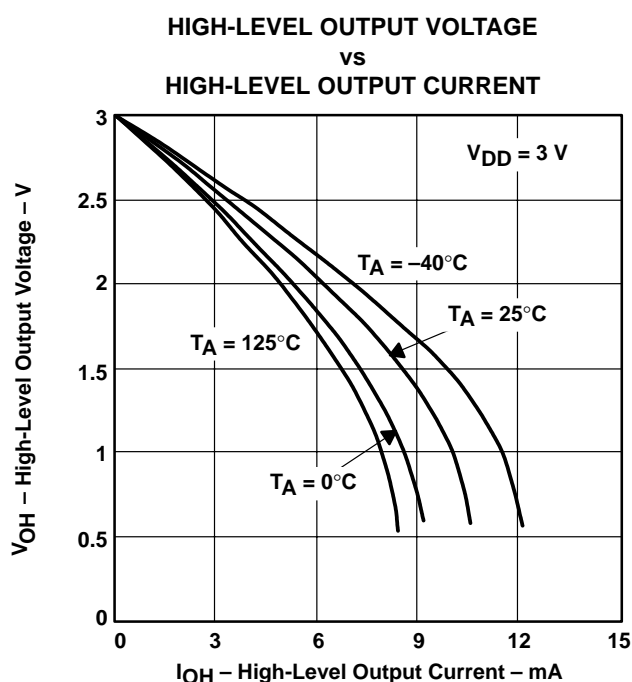
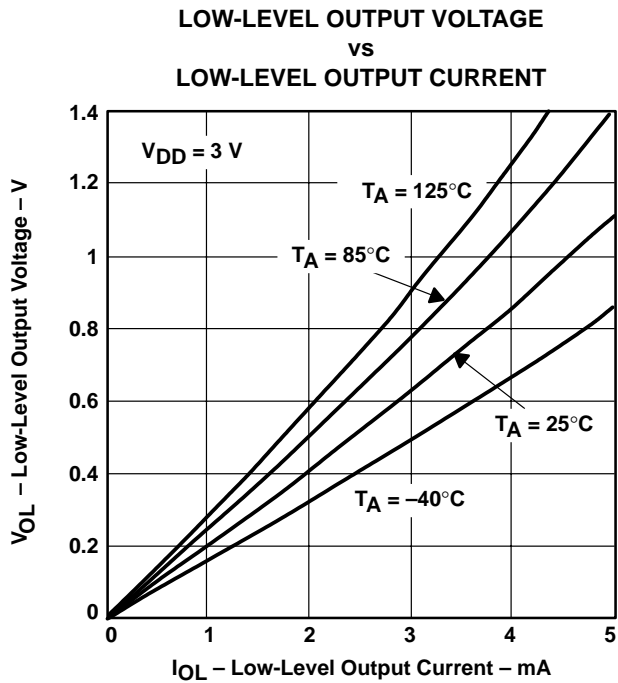

Figure 9

**TLV2432, TLV2432A, TLV2434, TLV2434A**  
**Advanced LinCMOS™ RAIL-TO-RAIL OUTPUT**  
**WIDE-INPUT-VOLTAGE OPERATIONAL AMPLIFIERS**

SLOS168F – NOVEMBER 1996 – REVISED MARCH 2001

**TYPICAL CHARACTERISTICS**



**Figure 10**

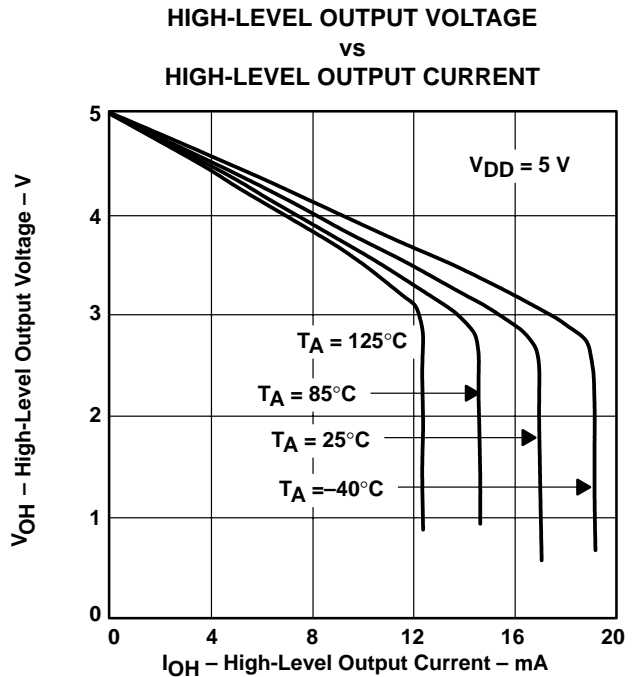

**Figure 11**

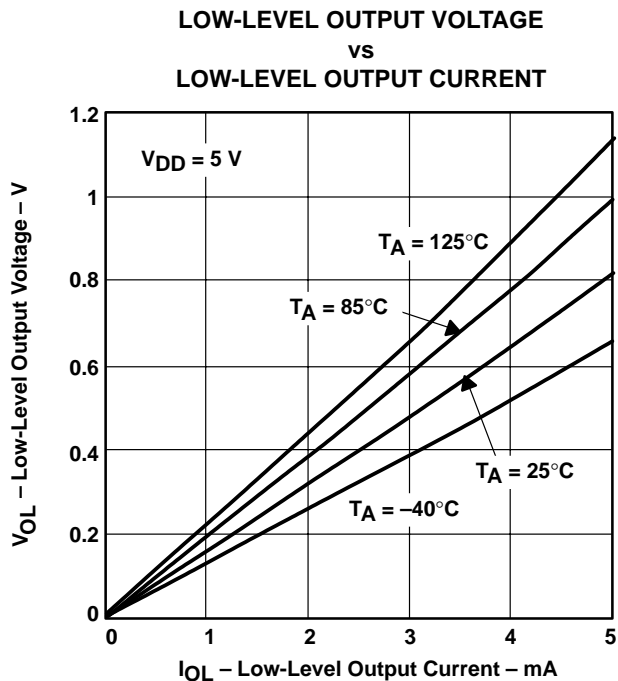

**Figure 12**

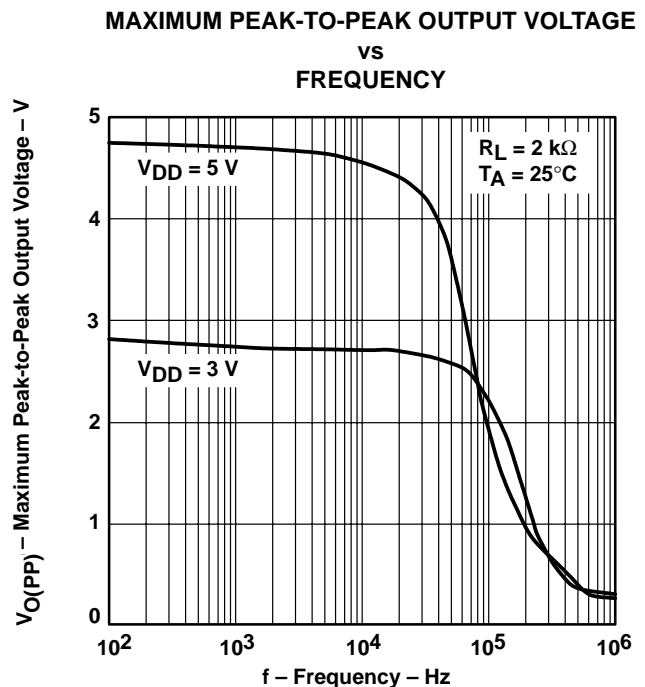

**Figure 13**



TYPICAL CHARACTERISTICS

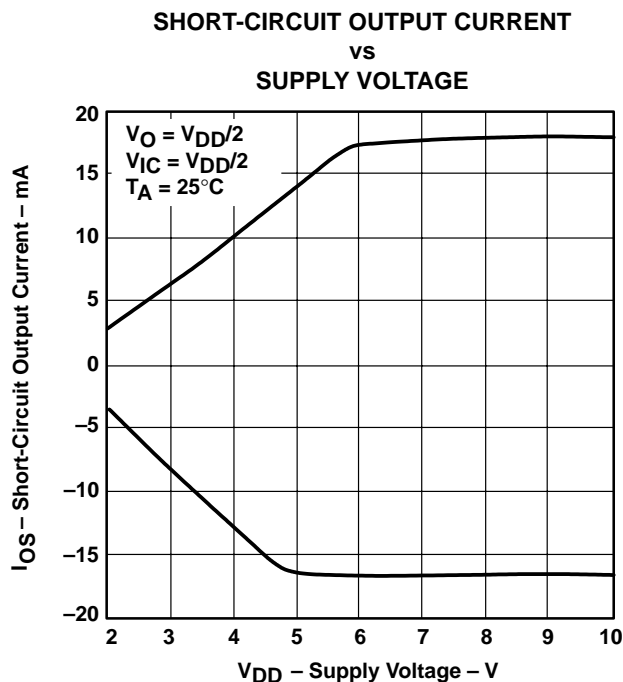

Figure 14

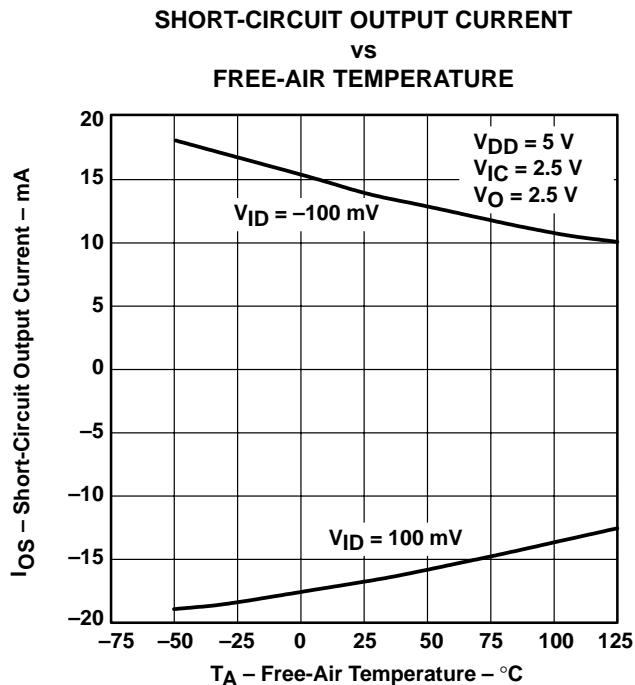

Figure 15

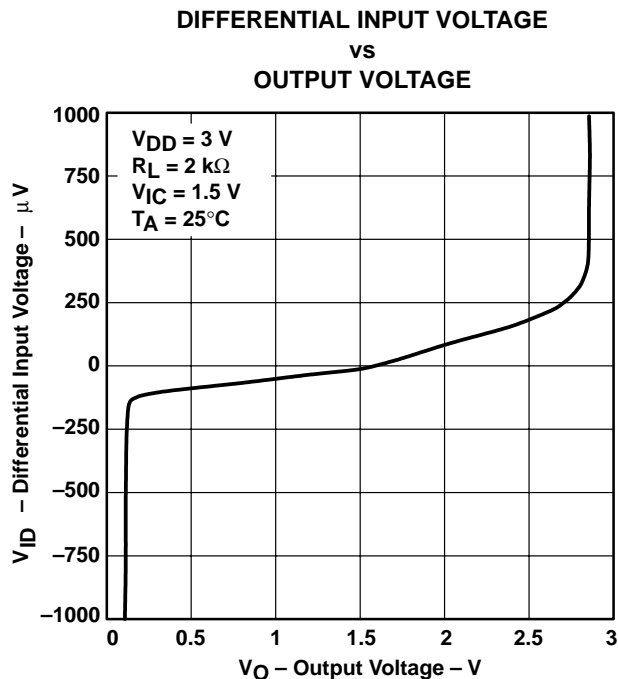

Figure 16

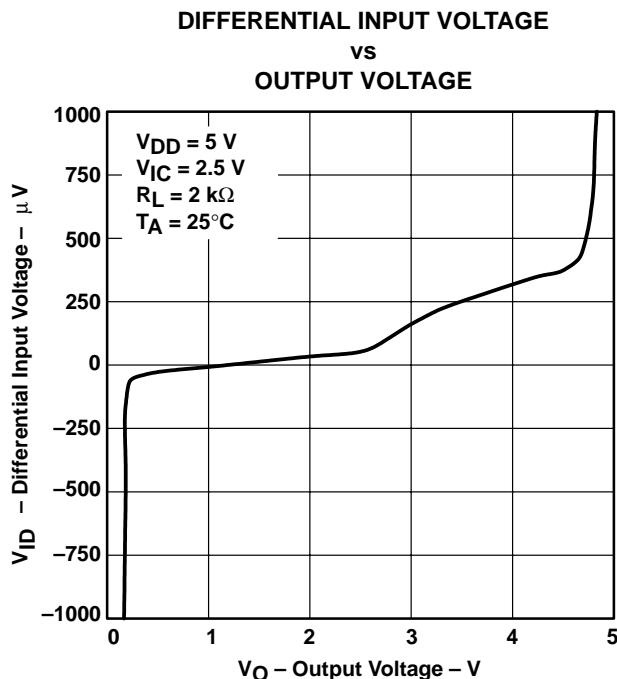

Figure 17

TYPICAL CHARACTERISTICS

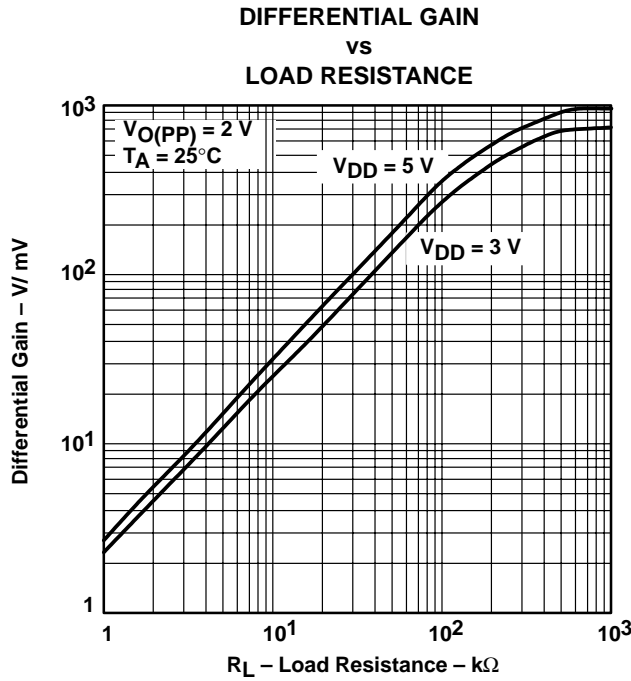

Figure 18

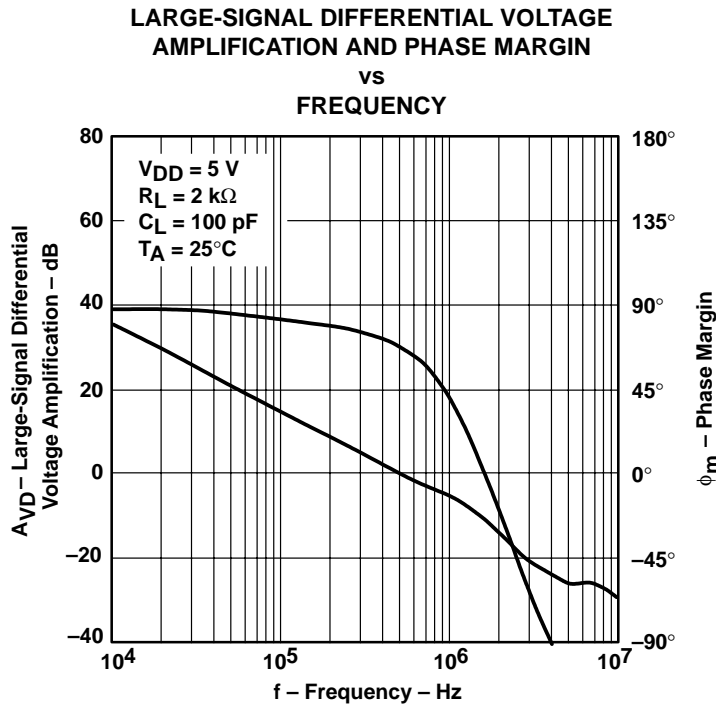

Figure 19

TYPICAL CHARACTERISTICS

LARGE-SIGNAL DIFFERENTIAL VOLTAGE  
 AMPLIFICATION AND PHASE MARGIN

vs  
 FREQUENCY

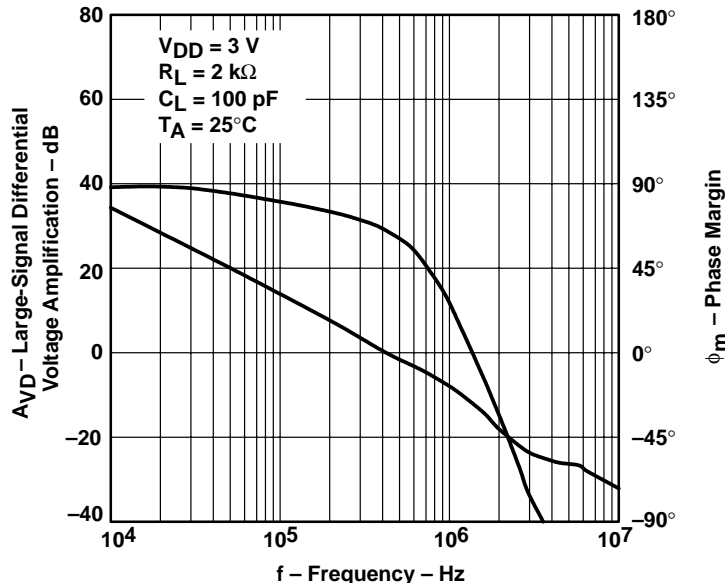

Figure 20

DIFFERENTIAL VOLTAGE AMPLIFICATION  
 vs  
 FREE-AIR TEMPERATURE

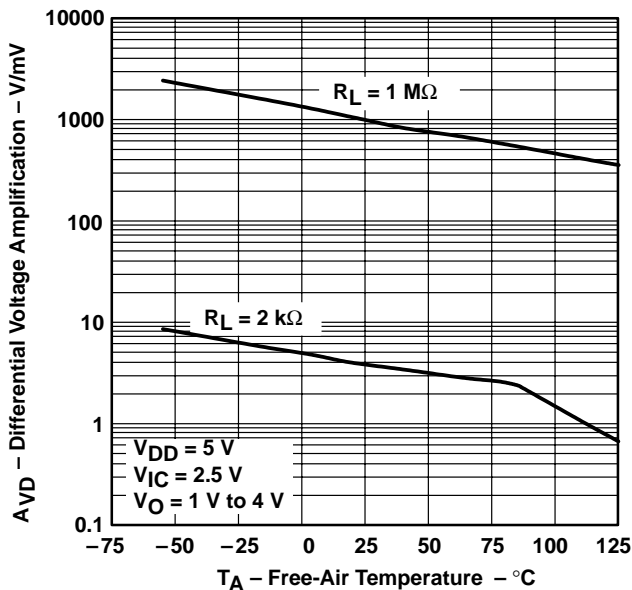

Figure 21

DIFFERENTIAL VOLTAGE AMPLIFICATION  
 vs  
 FREE-AIR TEMPERATURE

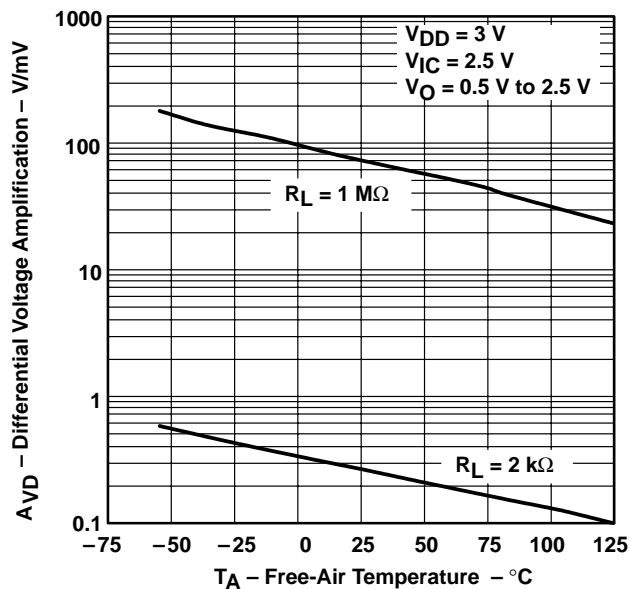

Figure 22

**TLV2432, TLV2432A, TLV2434, TLV2434A**  
**Advanced LinCMOS™ RAIL-TO-RAIL OUTPUT**  
**WIDE-INPUT-VOLTAGE OPERATIONAL AMPLIFIERS**

SLOS168F – NOVEMBER 1996 – REVISED MARCH 2001

**TYPICAL CHARACTERISTICS**

**OUTPUT IMPEDANCE  
 VS  
 FREQUENCY**

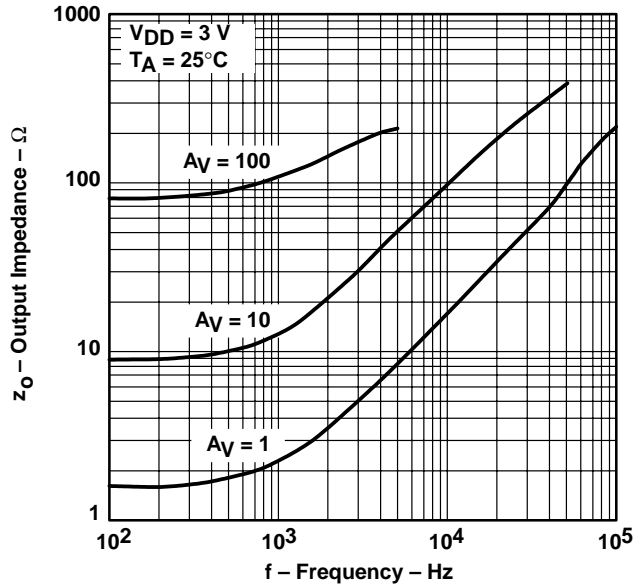

**Figure 23**

**OUTPUT IMPEDANCE  
 VS  
 FREQUENCY**

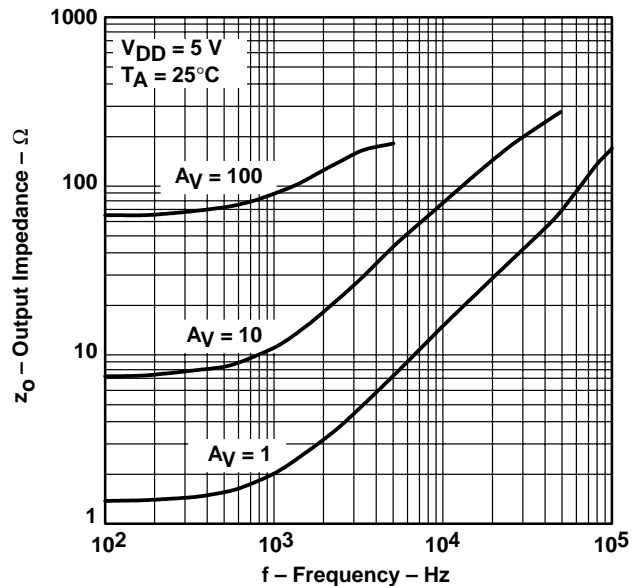

**Figure 24**

**COMMON-MODE REJECTION RATIO  
 VS  
 FREQUENCY**

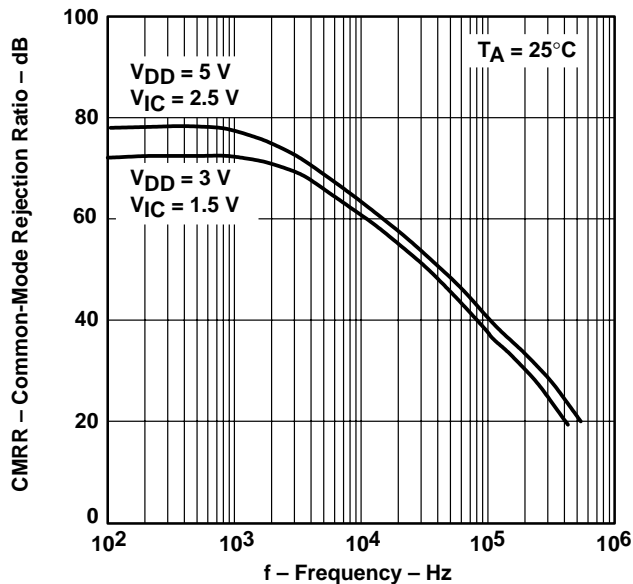

**Figure 25**

**COMMON-MODE REJECTION RATIO  
 VS  
 FREE-AIR TEMPERATURE**

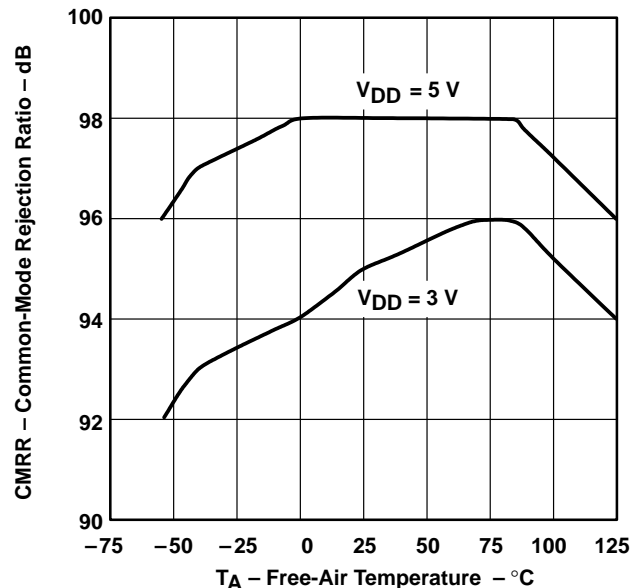

**Figure 26**



TYPICAL CHARACTERISTICS

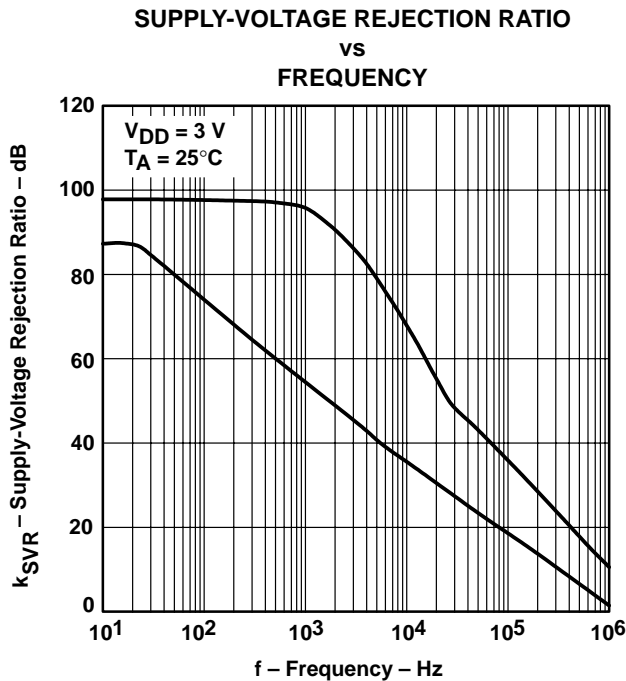

Figure 27

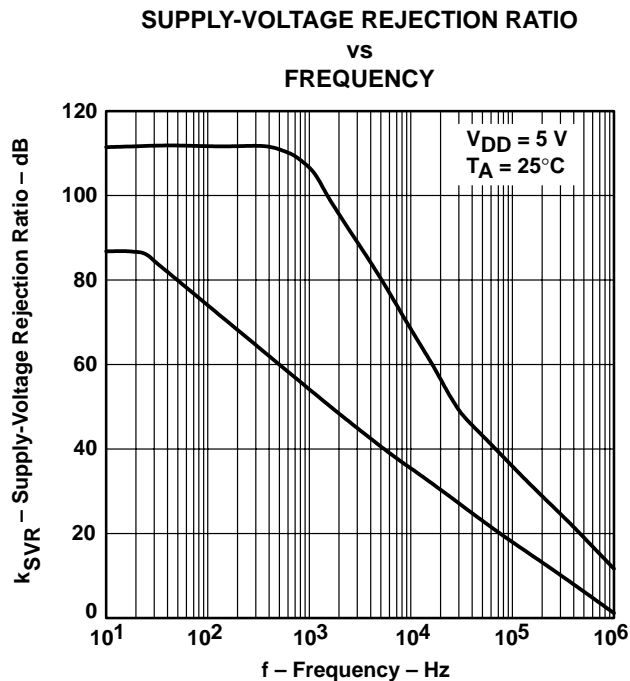

Figure 28

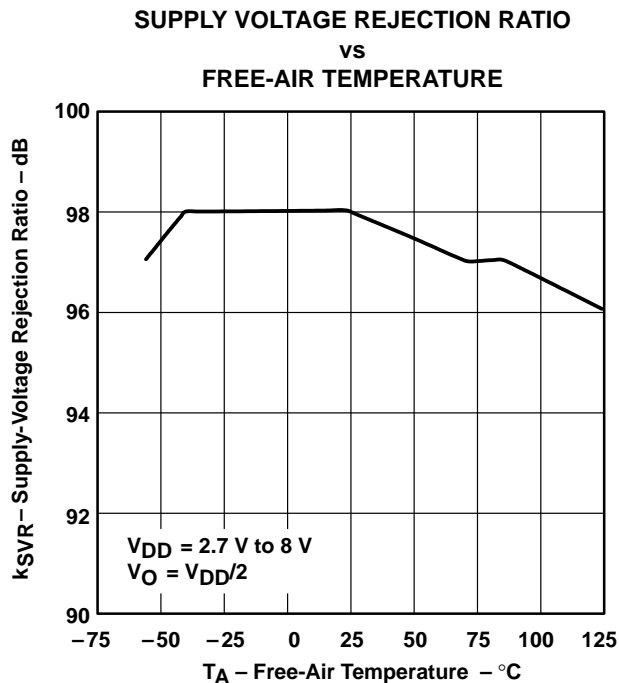

Figure 29

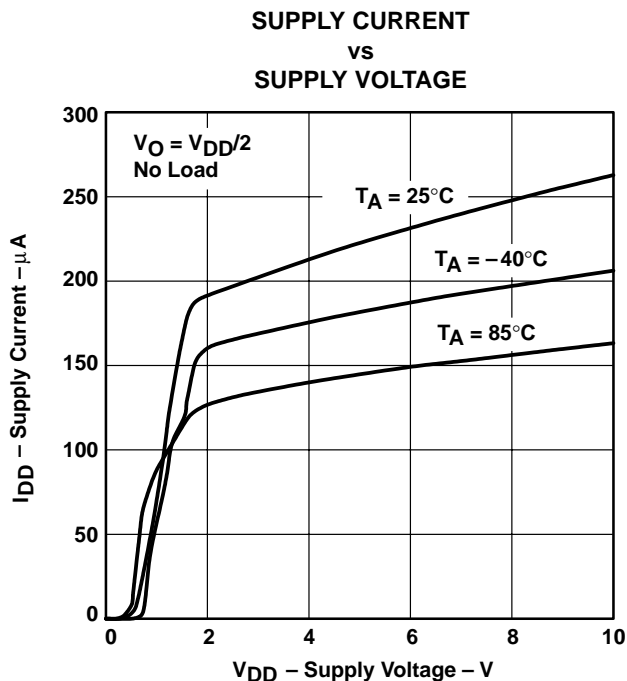
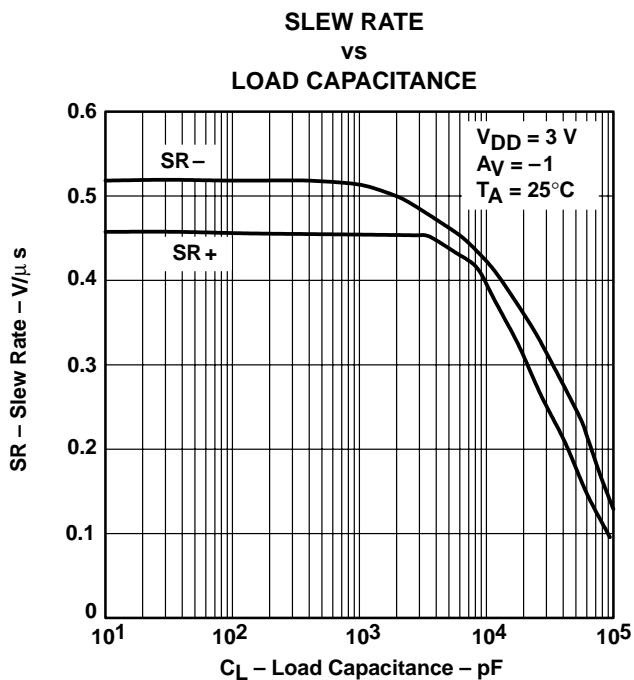
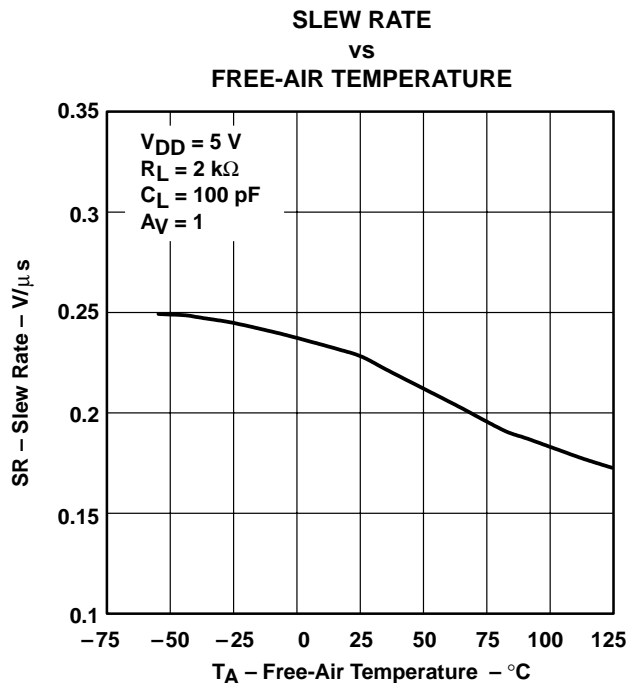

Figure 30

**TYPICAL CHARACTERISTICS**



**Figure 31**



**Figure 32**

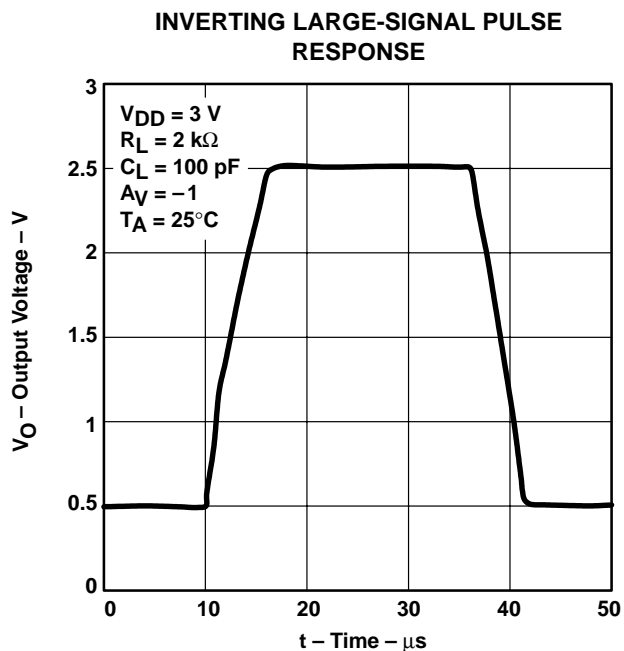

**Figure 33**

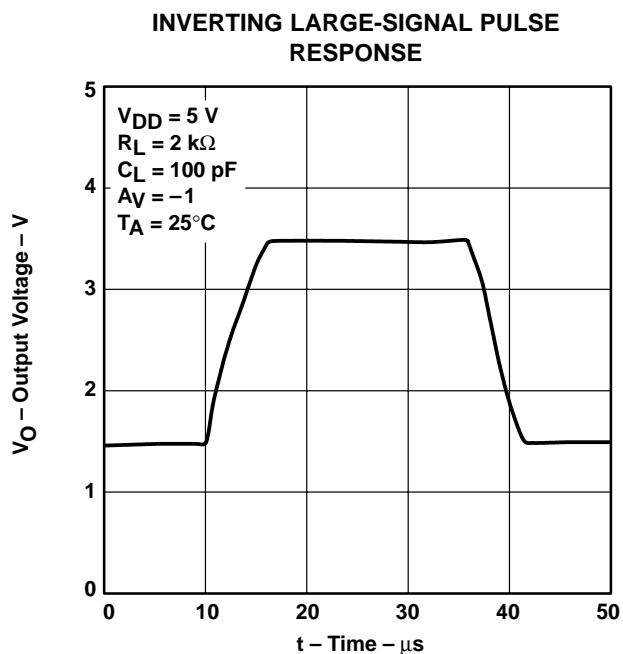

**Figure 34**

TYPICAL CHARACTERISTICS

VOLTAGE-FOLLOWER LARGE-SIGNAL PULSE RESPONSE

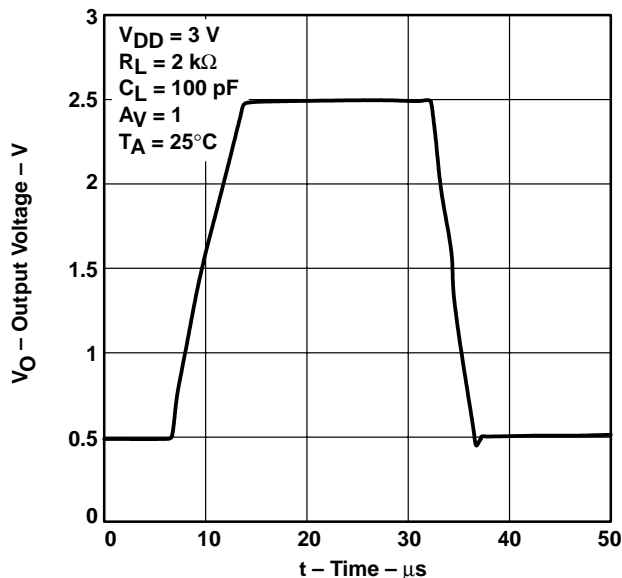

Figure 35

VOLTAGE-FOLLOWER LARGE-SIGNAL PULSE RESPONSE

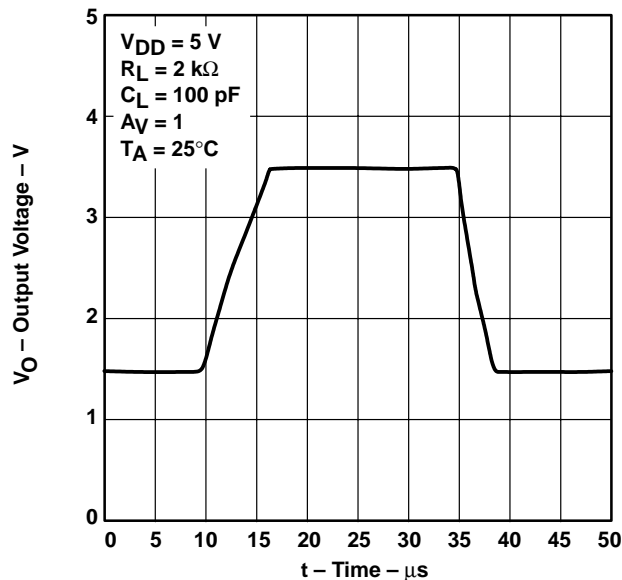

Figure 36

INVERTING SMALL-SIGNAL PULSE RESPONSE

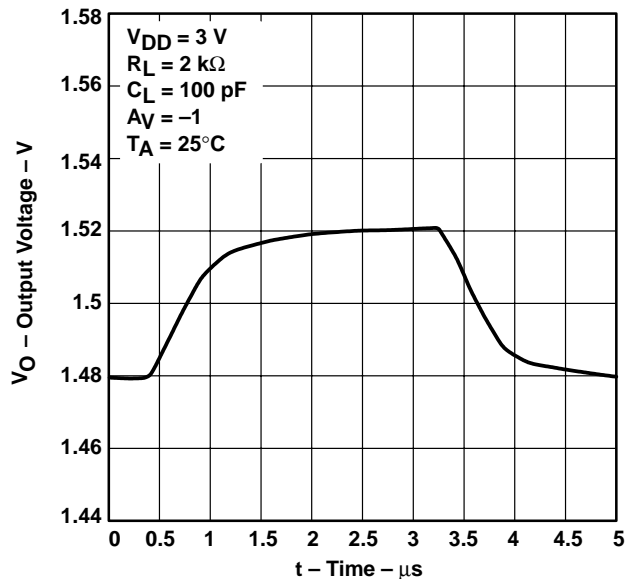

Figure 37

INVERTING SMALL-SIGNAL PULSE RESPONSE

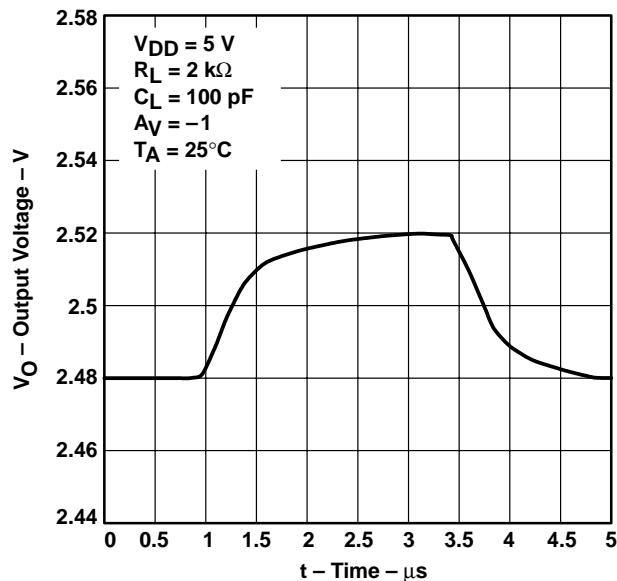

Figure 38

**TLV2432, TLV2432A, TLV2434, TLV2434A**  
**Advanced LinCMOS™ RAIL-TO-RAIL OUTPUT**  
**WIDE-INPUT-VOLTAGE OPERATIONAL AMPLIFIERS**

SLOS168F – NOVEMBER 1996 – REVISED MARCH 2001

**TYPICAL CHARACTERISTICS**

**VOLTAGE-FOLLOWER SMALL-SIGNAL PULSE RESPONSE**

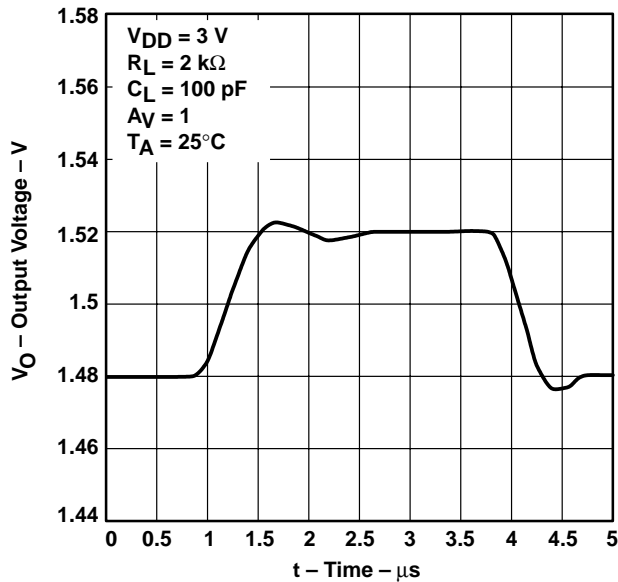

**Figure 39**

**VOLTAGE-FOLLOWER SMALL-SIGNAL PULSE RESPONSE**

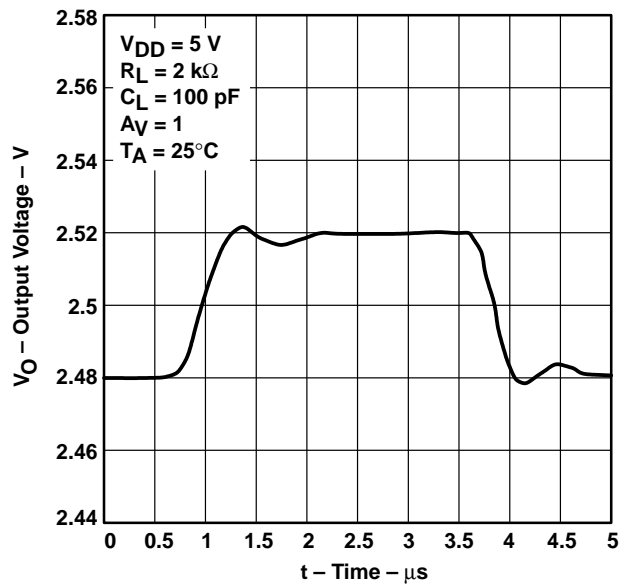

**Figure 40**

**EQUIVALENT INPUT NOISE VOLTAGE VS FREQUENCY**

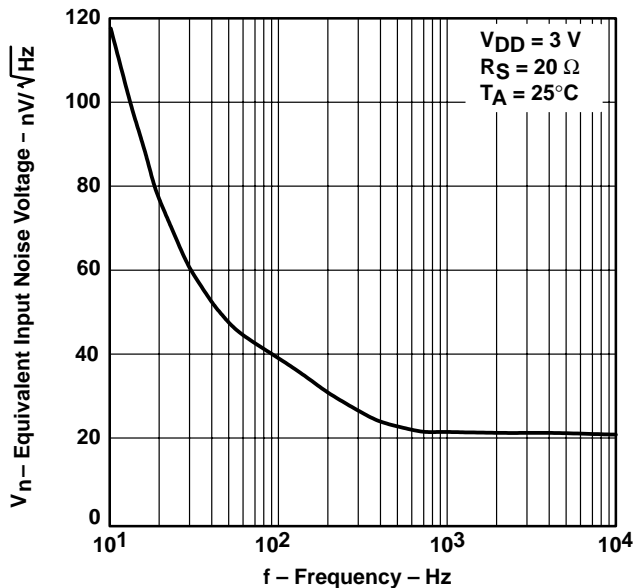

**Figure 41**

**EQUIVALENT INPUT NOISE VOLTAGE VS FREQUENCY**

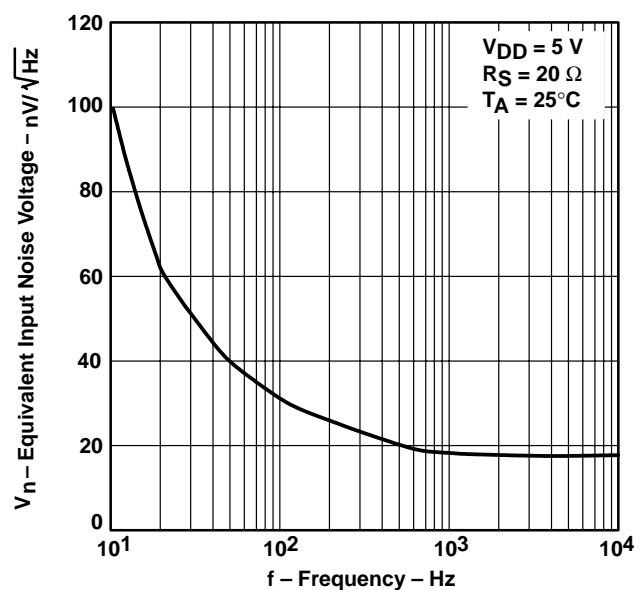

**Figure 42**



TYPICAL CHARACTERISTICS

NOISE VOLTAGE OVER A 10-SECOND PERIOD

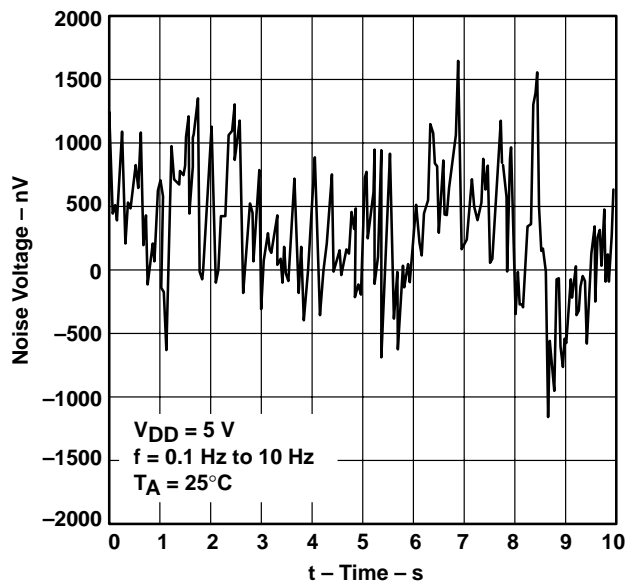

Figure 43

TOTAL HARMONIC DISTORTION PLUS NOISE  
 VS  
 FREQUENCY

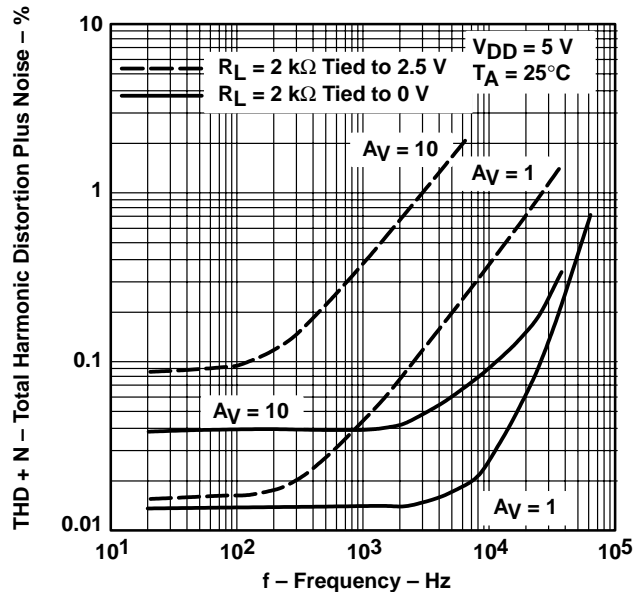

Figure 44

TOTAL HARMONIC DISTORTION PLUS NOISE  
 VS  
 FREQUENCY

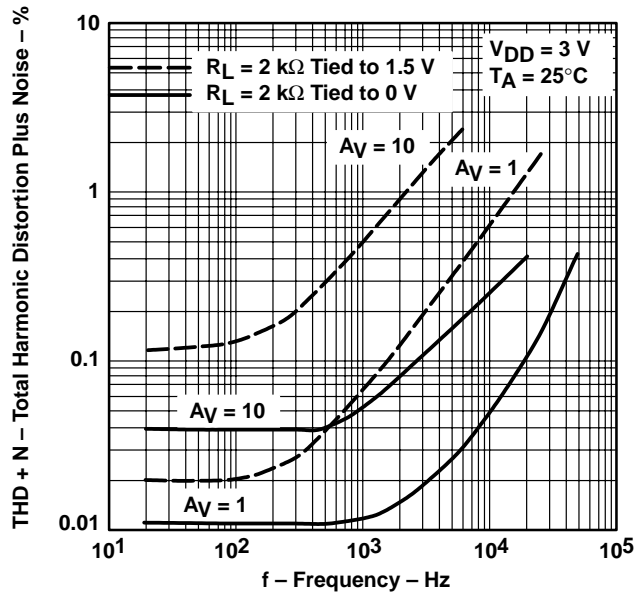

Figure 45

**TLV2432, TLV2432A, TLV2434, TLV2434A**  
**Advanced LinCMOS™ RAIL-TO-RAIL OUTPUT**  
**WIDE-INPUT-VOLTAGE OPERATIONAL AMPLIFIERS**

SLOS168F – NOVEMBER 1996 – REVISED MARCH 2001

**TYPICAL CHARACTERISTICS**

**GAIN-BANDWIDTH PRODUCT**  
**vs**  
**FREE-AIR TEMPERATURE**

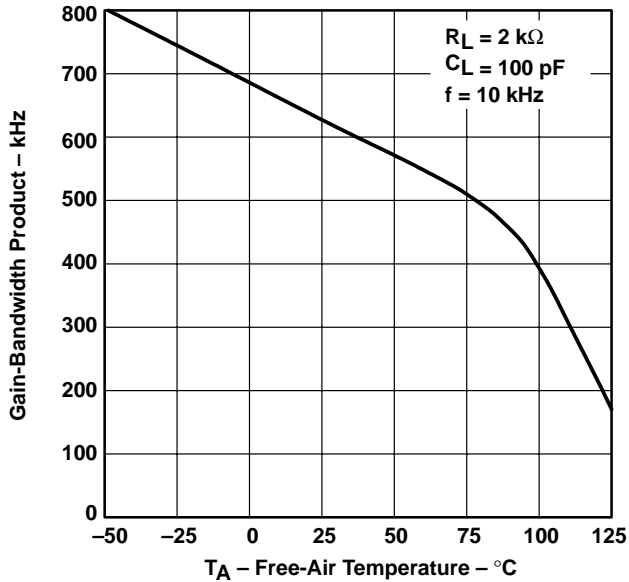

**Figure 46**

**GAIN-BANDWIDTH PRODUCT**  
**vs**  
**SUPPLY VOLTAGE**

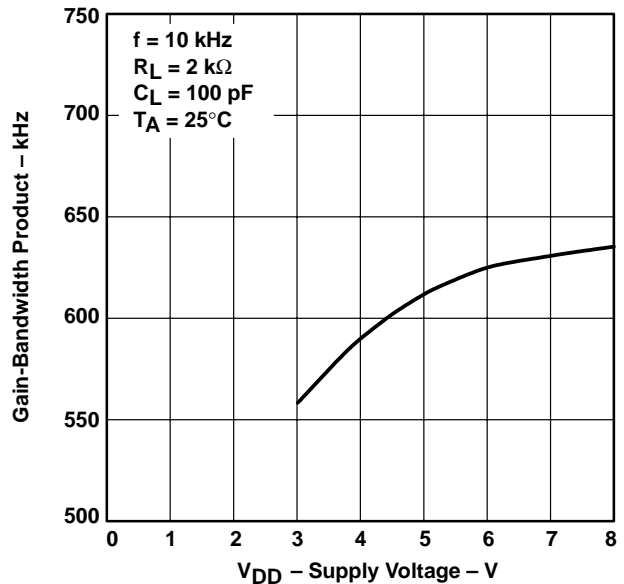

**Figure 47**

**PHASE MARGIN**  
**vs**  
**LOAD CAPACITANCE**

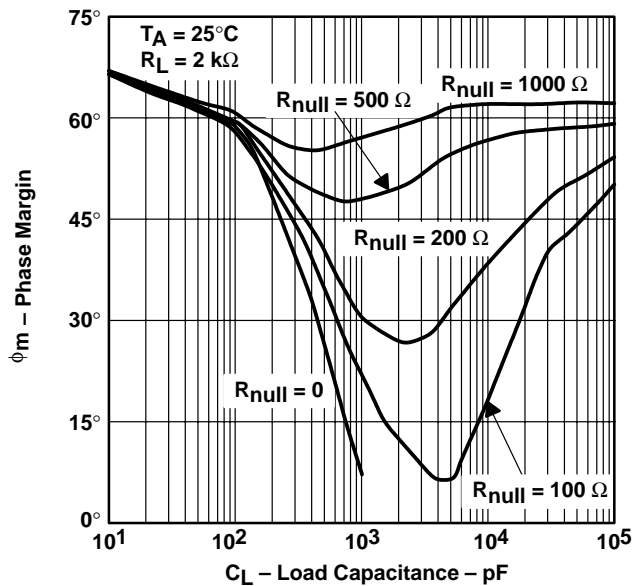

**Figure 48**

**GAIN MARGIN**  
**vs**  
**LOAD CAPACITANCE**

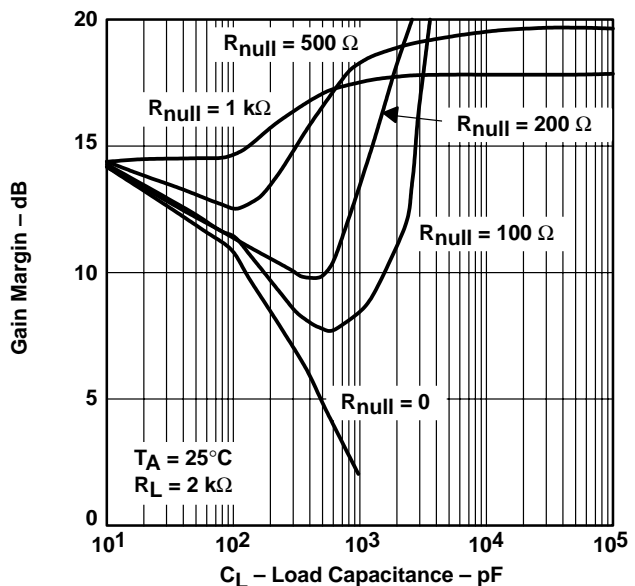

**Figure 49**



TYPICAL CHARACTERISTICS

UNITY-GAIN BANDWIDTH  
vs  
LOAD CAPACITANCE

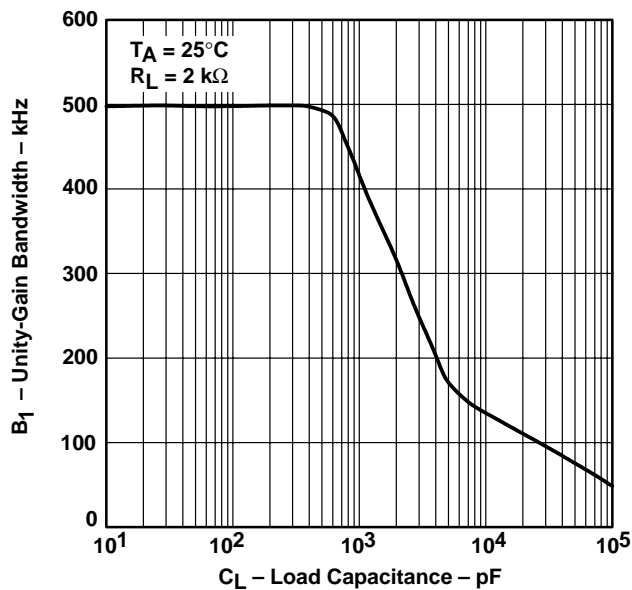

Figure 50

# TLV2432, TLV2432A, TLV2434, TLV2434A Advanced LinCMOS™ RAIL-TO-RAIL OUTPUT WIDE-INPUT-VOLTAGE OPERATIONAL AMPLIFIERS

SLOS168F – NOVEMBER 1996 – REVISED MARCH 2001

## APPLICATION INFORMATION

### macromodel information

Macromodel information provided was derived using Microsim *Parts*™, the model generation software used with Microsim *PSpice*™. The Boyle macromodel (see Note 5) and subcircuit in Figure 51 are generated using the TLV243x typical electrical and operating characteristics at  $T_A = 25^\circ\text{C}$ . Using this information, output simulations of the following key parameters can be generated to a tolerance of 20% (in most cases):

- Maximum positive output voltage swing
- Maximum negative output voltage swing
- Slew rate
- Quiescent power dissipation
- Input bias current
- Open-loop voltage amplification
- Unity-gain frequency
- Common-mode rejection ratio
- Phase margin
- DC output resistance
- AC output resistance
- Short-circuit output current limit

NOTE 4: G. R. Boyle, B. M. Cohn, D. O. Pederson, and J. E. Solomon, "Macromodeling of Integrated Circuit Operational Amplifiers", *IEEE Journal of Solid-State Circuits*, SC-9, 353 (1974).

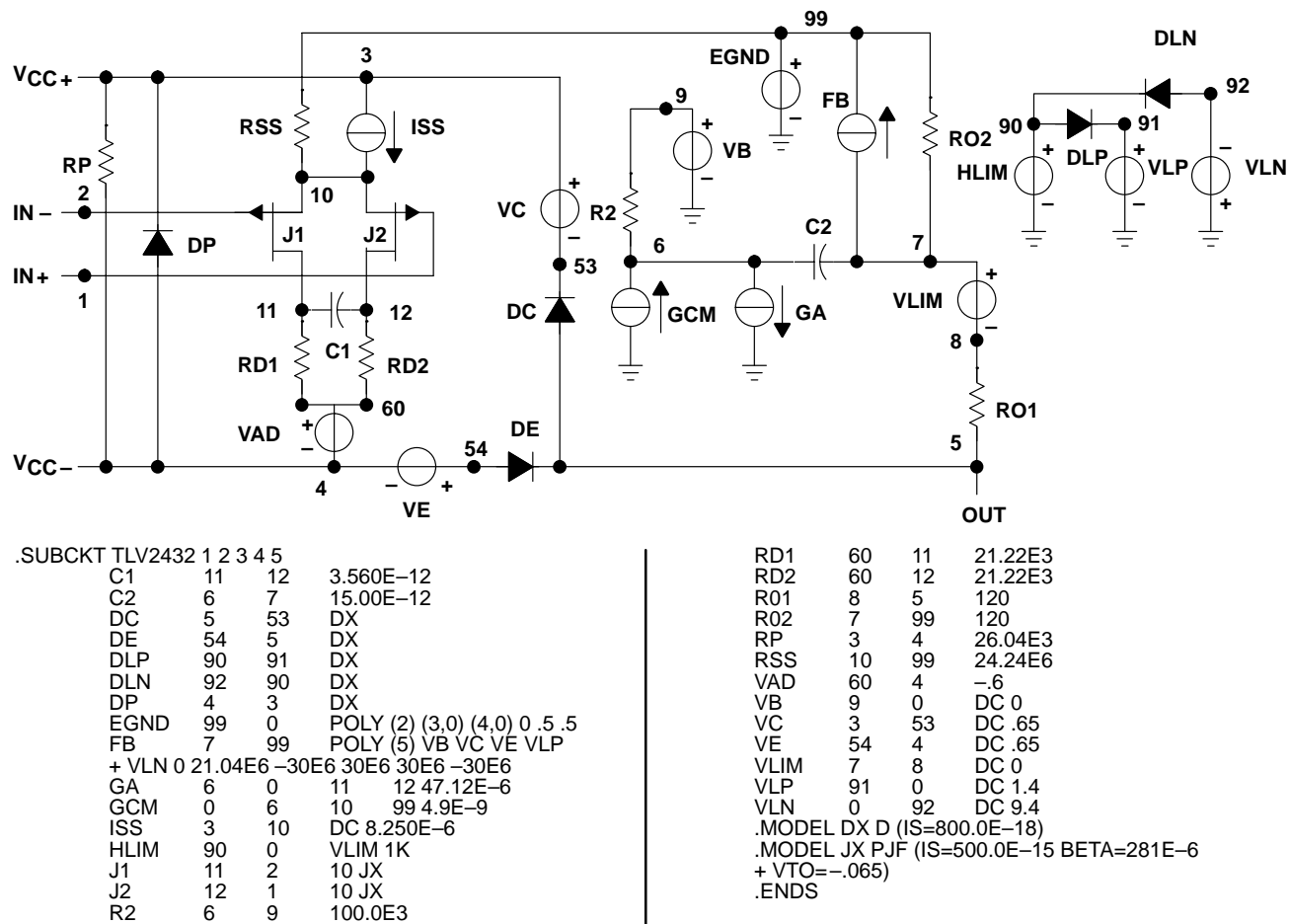

Figure 51. Boyle Macromodel and Subcircuit

PSpice and Parts are trademarks of MicroSim Corporation.



POST OFFICE BOX 655303 • DALLAS, TEXAS 75265

**PACKAGING INFORMATION**

| Orderable Device | Status<br>(1) | Package Type | Package Drawing | Pins | Package Qty | Eco Plan<br>(2)         | Lead/Ball Finish<br>(6) | MSL Peak Temp<br>(3) | Op Temp (°C) | Device Marking<br>(4/5)             | Samples                 |
|------------------|---------------|--------------|-----------------|------|-------------|-------------------------|-------------------------|----------------------|--------------|-------------------------------------|-------------------------|
| 5962-9751001Q2A  | OBSOLETE      | LCCC         | FK              | 20   |             | TBD                     | Call TI                 | Call TI              | -55 to 125   | 5962-9751001Q2A<br>TLV2432<br>MFKB  |                         |
| 5962-9751001QHA  | OBSOLETE      | CFP          | U               | 10   |             | TBD                     | Call TI                 | Call TI              | -55 to 125   | 9751001QHA<br>TLV2432M              |                         |
| 5962-9751001QPA  | OBSOLETE      | CDIP         | JG              | 8    |             | TBD                     | Call TI                 | Call TI              | -55 to 125   | 9751001QPA<br>TLV2432M              |                         |
| 5962-9751002Q2A  | OBSOLETE      | LCCC         | FK              | 20   |             | TBD                     | Call TI                 | Call TI              | -55 to 125   | 5962-9751002Q2A<br>TLV2432<br>AMFKB |                         |
| 5962-9751002QHA  | OBSOLETE      | CFP          | U               | 10   |             | TBD                     | Call TI                 | Call TI              | -55 to 125   | 9751002QHA<br>TLV2432AM             |                         |
| 5962-9751002QPA  | OBSOLETE      | CDIP         | JG              | 8    |             | TBD                     | Call TI                 | Call TI              | -55 to 125   | 9751002QPA<br>TLV2432AM             |                         |
| TLV2432AID       | ACTIVE        | SOIC         | D               | 8    | 75          | Green (RoHS & no Sb/Br) | CU NIPDAU               | Level-1-260C-UNLIM   | -40 to 85    | 2432AI                              | <a href="#">Samples</a> |
| TLV2432AIDG4     | ACTIVE        | SOIC         | D               | 8    | 75          | Green (RoHS & no Sb/Br) | CU NIPDAU               | Level-1-260C-UNLIM   | -40 to 85    | 2432AI                              | <a href="#">Samples</a> |
| TLV2432AIDR      | ACTIVE        | SOIC         | D               | 8    | 2500        | Green (RoHS & no Sb/Br) | CU NIPDAU               | Level-1-260C-UNLIM   | -40 to 85    | 2432AI                              | <a href="#">Samples</a> |
| TLV2432AIDRG4    | ACTIVE        | SOIC         | D               | 8    | 2500        | Green (RoHS & no Sb/Br) | CU NIPDAU               | Level-1-260C-UNLIM   | -40 to 85    | 2432AI                              | <a href="#">Samples</a> |
| TLV2432AIPW      | ACTIVE        | TSSOP        | PW              | 8    | 150         | Green (RoHS & no Sb/Br) | CU NIPDAU               | Level-1-260C-UNLIM   | -40 to 85    | TV2432                              | <a href="#">Samples</a> |
| TLV2432AIPWG4    | ACTIVE        | TSSOP        | PW              | 8    | 150         | Green (RoHS & no Sb/Br) | CU NIPDAU               | Level-1-260C-UNLIM   | -40 to 85    | TV2432                              | <a href="#">Samples</a> |
| TLV2432AIPWLE    | OBSOLETE      | TSSOP        | PW              | 8    |             | TBD                     | Call TI                 | Call TI              | -40 to 85    |                                     |                         |
| TLV2432AIPWR     | ACTIVE        | TSSOP        | PW              | 8    | 2000        | Green (RoHS & no Sb/Br) | CU NIPDAU               | Level-1-260C-UNLIM   | -40 to 85    | 2432AI                              | <a href="#">Samples</a> |
| TLV2432AIPWRG4   | ACTIVE        | TSSOP        | PW              | 8    | 2000        | Green (RoHS & no Sb/Br) | CU NIPDAU               | Level-1-260C-UNLIM   | -40 to 85    | 2432AI                              | <a href="#">Samples</a> |
| TLV2432AMFKB     | OBSOLETE      | LCCC         | FK              | 20   |             | TBD                     | Call TI                 | Call TI              | -55 to 125   | 5962-9751002Q2A                     |                         |

| Orderable Device | Status<br>(1) | Package Type | Package Drawing | Pins | Package Qty | Eco Plan<br>(2)            | Lead/Ball Finish<br>(6) | MSL Peak Temp<br>(3) | Op Temp (°C) | Device Marking<br>(4/5)                | Samples                 |
|------------------|---------------|--------------|-----------------|------|-------------|----------------------------|-------------------------|----------------------|--------------|--|-------------------------|
|                  |               |              |                 |      |             |                            |                         |                      |              | TLV2432<br>AMFKB                       |                         |
| TLV2432AMJGB     | OBSOLETE      | CDIP         | JG              | 8    |             | TBD                        | Call TI                 | Call TI              | -55 to 125   | 9751002QPA<br>TLV2432AM                |                         |
| TLV2432AMUB      | OBSOLETE      | CFP          | U               | 10   |             | TBD                        | Call TI                 | Call TI              | -55 to 125   | 9751002QHA<br>TLV2432AM                |                         |
| TLV2432AQD       | ACTIVE        | SOIC         | D               | 8    | 75          | Green (RoHS<br>& no Sb/Br) | CU NIPDAU               | Level-1-260C-UNLIM   | -40 to 125   | V2432A                                 | <a href="#">Samples</a> |
| TLV2432AQDG4     | ACTIVE        | SOIC         | D               | 8    | 75          | Green (RoHS<br>& no Sb/Br) | CU NIPDAU               | Level-1-260C-UNLIM   | -40 to 125   | V2432A                                 | <a href="#">Samples</a> |
| TLV2432AQDR      | OBSOLETE      | SOIC         | D               | 8    |             | TBD                        | Call TI                 | Call TI              | -40 to 125   |  |                         |
| TLV2432AQDRG4    | ACTIVE        | SOIC         | D               | 8    | 2500        | Green (RoHS<br>& no Sb/Br) | CU NIPDAU               | Level-1-260C-UNLIM   | -40 to 125   | V2432A                                 | <a href="#">Samples</a> |
| TLV2432CD        | ACTIVE        | SOIC         | D               | 8    | 75          | Green (RoHS<br>& no Sb/Br) | CU NIPDAU               | Level-1-260C-UNLIM   | 0 to 70      | 2432C                                  | <a href="#">Samples</a> |
| TLV2432CDG4      | ACTIVE        | SOIC         | D               | 8    |             | TBD                        | Call TI                 | Call TI              | 0 to 70      |  | <a href="#">Samples</a> |
| TLV2432CDR       | ACTIVE        | SOIC         | D               | 8    | 2500        | Green (RoHS<br>& no Sb/Br) | CU NIPDAU               | Level-1-260C-UNLIM   | 0 to 70      | 2432C                                  | <a href="#">Samples</a> |
| TLV2432CDRG4     | ACTIVE        | SOIC         | D               | 8    | 2500        | Green (RoHS<br>& no Sb/Br) | CU NIPDAU               | Level-1-260C-UNLIM   | 0 to 70      | 2432C                                  | <a href="#">Samples</a> |
| TLV2432ID        | ACTIVE        | SOIC         | D               | 8    | 75          | Green (RoHS<br>& no Sb/Br) | CU NIPDAU               | Level-1-260C-UNLIM   | -40 to 85    | 2432I                                  | <a href="#">Samples</a> |
| TLV2432IDG4      | ACTIVE        | SOIC         | D               | 8    | 75          | Green (RoHS<br>& no Sb/Br) | CU NIPDAU               | Level-1-260C-UNLIM   | -40 to 85    | 2432I                                  | <a href="#">Samples</a> |
| TLV2432IDR       | ACTIVE        | SOIC         | D               | 8    | 2500        | Green (RoHS<br>& no Sb/Br) | CU NIPDAU               | Level-1-260C-UNLIM   | -40 to 85    | 2432I                                  | <a href="#">Samples</a> |
| TLV2432IDRG4     | ACTIVE        | SOIC         | D               | 8    | 2500        | Green (RoHS<br>& no Sb/Br) | CU NIPDAU               | Level-1-260C-UNLIM   | -40 to 85    | 2432I                                  | <a href="#">Samples</a> |
| TLV2432MFKB      | OBSOLETE      | LCCC         | FK              | 20   |             | TBD                        | Call TI                 | Call TI              | -55 to 125   | 5962-<br>9751001Q2A<br>TLV2432<br>MFKB |                         |
| TLV2432MJGB      | OBSOLETE      | CDIP         | JG              | 8    |             | TBD                        | Call TI                 | Call TI              | -55 to 125   | 9751001QPA<br>TLV2432M                 |                         |
| TLV2432MUB       | OBSOLETE      | CFP          | U               | 10   |             | TBD                        | Call TI                 | Call TI              | -55 to 125   | 9751001QHA<br>TLV2432M                 |                         |

| Orderable Device | Status<br>(1) | Package Type | Package Drawing | Pins | Package Qty | Eco Plan<br>(2)         | Lead/Ball Finish<br>(6) | MSL Peak Temp<br>(3) | Op Temp (°C) | Device Marking<br>(4/5) | Samples                 |
|------------------|---------------|--------------|-----------------|------|-------------|-------------------------|-------------------------|----------------------|--------------|-------------------------|-------------------------|
| TLV2432QD        | ACTIVE        | SOIC         | D               | 8    | 75          | Green (RoHS & no Sb/Br) | CU NIPDAU               | Level-1-260C-UNLIM   | -40 to 125   | V2432Q                  | <a href="#">Samples</a> |
| TLV2432QDG4      | ACTIVE        | SOIC         | D               | 8    | 75          | Green (RoHS & no Sb/Br) | CU NIPDAU               | Level-1-260C-UNLIM   | -40 to 125   | V2432Q                  | <a href="#">Samples</a> |
| TLV2432QDR       | OBSOLETE      | SOIC         | D               | 8    |             | TBD                     | Call TI                 | Call TI              | -40 to 125   |                         |                         |
| TLV2434AID       | ACTIVE        | SOIC         | D               | 14   | 50          | Green (RoHS & no Sb/Br) | CU NIPDAU               | Level-1-260C-UNLIM   | -40 to 85    | 2434AI                  | <a href="#">Samples</a> |
| TLV2434AIDG4     | ACTIVE        | SOIC         | D               | 14   | 50          | Green (RoHS & no Sb/Br) | CU NIPDAU               | Level-1-260C-UNLIM   | -40 to 85    | 2434AI                  | <a href="#">Samples</a> |
| TLV2434AIDR      | ACTIVE        | SOIC         | D               | 14   | 2500        | Green (RoHS & no Sb/Br) | CU NIPDAU               | Level-1-260C-UNLIM   | -40 to 85    | 2434AI                  | <a href="#">Samples</a> |
| TLV2434AIPWR     | ACTIVE        | TSSOP        | PW              | 14   | 2000        | Green (RoHS & no Sb/Br) | CU NIPDAU               | Level-1-260C-UNLIM   | -40 to 85    | 2434AI                  | <a href="#">Samples</a> |
| TLV2434CD        | ACTIVE        | SOIC         | D               | 14   | 50          | Green (RoHS & no Sb/Br) | CU NIPDAU               | Level-1-260C-UNLIM   | 0 to 70      | 2434C                   | <a href="#">Samples</a> |
| TLV2434CDR       | ACTIVE        | SOIC         | D               | 14   | 2500        | Green (RoHS & no Sb/Br) | CU NIPDAU               | Level-1-260C-UNLIM   | 0 to 70      | 2434C                   | <a href="#">Samples</a> |
| TLV2434CPW       | ACTIVE        | TSSOP        | PW              | 14   | 90          | Green (RoHS & no Sb/Br) | CU NIPDAU               | Level-1-260C-UNLIM   | 0 to 70      | 2434C                   | <a href="#">Samples</a> |
| TLV2434CPWR      | ACTIVE        | TSSOP        | PW              | 14   | 2000        | Green (RoHS & no Sb/Br) | CU NIPDAU               | Level-1-260C-UNLIM   | 0 to 70      | 2434C                   | <a href="#">Samples</a> |
| TLV2434ID        | ACTIVE        | SOIC         | D               | 14   | 50          | Green (RoHS & no Sb/Br) | CU NIPDAU               | Level-1-260C-UNLIM   | -40 to 85    | 2434I                   | <a href="#">Samples</a> |
| TLV2434IDG4      | ACTIVE        | SOIC         | D               | 14   | 50          | Green (RoHS & no Sb/Br) | CU NIPDAU               | Level-1-260C-UNLIM   | -40 to 85    | 2434I                   | <a href="#">Samples</a> |
| TLV2434IDR       | ACTIVE        | SOIC         | D               | 14   | 2500        | Green (RoHS & no Sb/Br) | CU NIPDAU               | Level-1-260C-UNLIM   | -40 to 85    | 2434I                   | <a href="#">Samples</a> |
| TLV2434IDRG4     | ACTIVE        | SOIC         | D               | 14   | 2500        | Green (RoHS & no Sb/Br) | CU NIPDAU               | Level-1-260C-UNLIM   | -40 to 85    | 2434I                   | <a href="#">Samples</a> |
| TLV2434IPW       | ACTIVE        | TSSOP        | PW              | 14   | 90          | Green (RoHS & no Sb/Br) | CU NIPDAU               | Level-1-260C-UNLIM   | -40 to 85    | 2434I                   | <a href="#">Samples</a> |
| TLV2434IPWG4     | ACTIVE        | TSSOP        | PW              | 14   | 90          | Green (RoHS & no Sb/Br) | CU NIPDAU               | Level-1-260C-UNLIM   | -40 to 85    | 2434I                   | <a href="#">Samples</a> |
| TLV2434IPWR      | ACTIVE        | TSSOP        | PW              | 14   | 2000        | Green (RoHS & no Sb/Br) | CU NIPDAU               | Level-1-260C-UNLIM   | -40 to 85    | 2434I                   | <a href="#">Samples</a> |

| Orderable Device | Status<br>(1) | Package Type | Package<br>Drawing | Pins | Package<br>Qty | Eco Plan<br>(2)            | Lead/Ball Finish<br>(6) | MSL Peak Temp<br>(3) | Op Temp (°C) | Device Marking<br>(4/5) | Samples        |
|------------------|---------------|--------------|--------------------|------|----------------|----------------------------|-------------------------|----------------------|--------------|-------------------------|----------------|
| TLV2434IPWRG4    | ACTIVE        | TSSOP        | PW                 | 14   | 2000           | Green (RoHS<br>& no Sb/Br) | CU NIPDAU               | Level-1-260C-UNLIM   | -40 to 85    | 2434I                   | <b>Samples</b> |

(1) The marketing status values are defined as follows:

**ACTIVE:** Product device recommended for new designs.

**LIFEBUY:** TI has announced that the device will be discontinued, and a lifetime-buy period is in effect.

**NRND:** Not recommended for new designs. Device is in production to support existing customers, but TI does not recommend using this part in a new design.

**PREVIEW:** Device has been announced but is not in production. Samples may or may not be available.

**OBSOLETE:** TI has discontinued the production of the device.

(2) Eco Plan - The planned eco-friendly classification: Pb-Free (RoHS), Pb-Free (RoHS Exempt), or Green (RoHS & no Sb/Br) - please check <http://www.ti.com/productcontent> for the latest availability information and additional product content details.

**TBD:** The Pb-Free/Green conversion plan has not been defined.

**Pb-Free (RoHS):** TI's terms "Lead-Free" or "Pb-Free" mean semiconductor products that are compatible with the current RoHS requirements for all 6 substances, including the requirement that lead not exceed 0.1% by weight in homogeneous materials. Where designed to be soldered at high temperatures, TI Pb-Free products are suitable for use in specified lead-free processes.

**Pb-Free (RoHS Exempt):** This component has a RoHS exemption for either 1) lead-based flip-chip solder bumps used between the die and package, or 2) lead-based die adhesive used between the die and leadframe. The component is otherwise considered Pb-Free (RoHS compatible) as defined above.

**Green (RoHS & no Sb/Br):** TI defines "Green" to mean Pb-Free (RoHS compatible), and free of Bromine (Br) and Antimony (Sb) based flame retardants (Br or Sb do not exceed 0.1% by weight in homogeneous material)

(3) MSL, Peak Temp. - The Moisture Sensitivity Level rating according to the JEDEC industry standard classifications, and peak solder temperature.

(4) There may be additional marking, which relates to the logo, the lot trace code information, or the environmental category on the device.

(5) Multiple Device Markings will be inside parentheses. Only one Device Marking contained in parentheses and separated by a "~" will appear on a device. If a line is indented then it is a continuation of the previous line and the two combined represent the entire Device Marking for that device.

(6) Lead/Ball Finish - Orderable Devices may have multiple material finish options. Finish options are separated by a vertical ruled line. Lead/Ball Finish values may wrap to two lines if the finish value exceeds the maximum column width.

**Important Information and Disclaimer:** The information provided on this page represents TI's knowledge and belief as of the date that it is provided. TI bases its knowledge and belief on information provided by third parties, and makes no representation or warranty as to the accuracy of such information. Efforts are underway to better integrate information from third parties. TI has taken and continues to take reasonable steps to provide representative and accurate information but may not have conducted destructive testing or chemical analysis on incoming materials and chemicals. TI and TI suppliers consider certain information to be proprietary, and thus CAS numbers and other limited information may not be available for release.

In no event shall TI's liability arising out of such information exceed the total purchase price of the TI part(s) at issue in this document sold by TI to Customer on an annual basis.

**OTHER QUALIFIED VERSIONS OF TLV2432, TLV2432A, TLV2432AM, TLV2432M, TLV2434A :**

- Catalog: [TLV2432A](#), [TLV2432](#)
- Automotive: [TLV2432-Q1](#), [TLV2432A-Q1](#), [TLV2432A-Q1](#), [TLV2432-Q1](#), [TLV2434A-Q1](#)
- Military: [TLV2432M](#), [TLV2432AM](#)

NOTE: Qualified Version Definitions:

- Catalog - TI's standard catalog product
- Automotive - Q100 devices qualified for high-reliability automotive applications targeting zero defects
- Military - QML certified for Military and Defense Applications

**TAPE AND REEL INFORMATION**

**QUADRANT ASSIGNMENTS FOR PIN 1 ORIENTATION IN TAPE**

\*All dimensions are nominal

| Device       | Package Type | Package Drawing | Pins | SPQ  | Reel Diameter (mm) | Reel Width W1 (mm) | A0 (mm) | B0 (mm) | K0 (mm) | P1 (mm) | W (mm) | Pin1 Quadrant |
|--------------|--------------|-----------------|------|------|--------------------|--------------------|---------|---------|---------|---------|--------|---------------|
| TLV2432AIDR  | SOIC         | D               | 8    | 2500 | 330.0              | 12.4               | 6.4     | 5.2     | 2.1     | 8.0     | 12.0   | Q1            |
| TLV2432AIPWR | TSSOP        | PW              | 8    | 2000 | 330.0              | 12.4               | 7.0     | 3.6     | 1.6     | 8.0     | 12.0   | Q1            |
| TLV2432CDR   | SOIC         | D               | 8    | 2500 | 330.0              | 12.4               | 6.4     | 5.2     | 2.1     | 8.0     | 12.0   | Q1            |
| TLV2432IDR   | SOIC         | D               | 8    | 2500 | 330.0              | 12.4               | 6.4     | 5.2     | 2.1     | 8.0     | 12.0   | Q1            |
| TLV2434AIDR  | SOIC         | D               | 14   | 2500 | 330.0              | 16.4               | 6.5     | 9.0     | 2.1     | 8.0     | 16.0   | Q1            |
| TLV2434AIPWR | TSSOP        | PW              | 14   | 2000 | 330.0              | 12.4               | 6.9     | 5.6     | 1.6     | 8.0     | 12.0   | Q1            |
| TLV2434CDR   | SOIC         | D               | 14   | 2500 | 330.0              | 16.4               | 6.5     | 9.0     | 2.1     | 8.0     | 16.0   | Q1            |
| TLV2434CPWR  | TSSOP        | PW              | 14   | 2000 | 330.0              | 12.4               | 6.9     | 5.6     | 1.6     | 8.0     | 12.0   | Q1            |
| TLV2434IDR   | SOIC         | D               | 14   | 2500 | 330.0              | 16.4               | 6.5     | 9.0     | 2.1     | 8.0     | 16.0   | Q1            |
| TLV2434IPWR  | TSSOP        | PW              | 14   | 2000 | 330.0              | 12.4               | 6.9     | 5.6     | 1.6     | 8.0     | 12.0   | Q1            |

**TAPE AND REEL BOX DIMENSIONS**

\*All dimensions are nominal

| Device       | Package Type | Package Drawing | Pins | SPQ  | Length (mm) | Width (mm) | Height (mm) |
|--------------|--------------|-----------------|------|------|-------------|------------|-------------|
| TLV2432AIDR  | SOIC         | D               | 8    | 2500 | 340.5       | 338.1      | 20.6        |
| TLV2432AIPWR | TSSOP        | PW              | 8    | 2000 | 367.0       | 367.0      | 35.0        |
| TLV2432CDR   | SOIC         | D               | 8    | 2500 | 340.5       | 338.1      | 20.6        |
| TLV2432IDR   | SOIC         | D               | 8    | 2500 | 340.5       | 338.1      | 20.6        |
| TLV2434AIDR  | SOIC         | D               | 14   | 2500 | 367.0       | 367.0      | 38.0        |
| TLV2434AIPWR | TSSOP        | PW              | 14   | 2000 | 367.0       | 367.0      | 35.0        |
| TLV2434CDR   | SOIC         | D               | 14   | 2500 | 367.0       | 367.0      | 38.0        |
| TLV2434CPWR  | TSSOP        | PW              | 14   | 2000 | 367.0       | 367.0      | 35.0        |
| TLV2434IDR   | SOIC         | D               | 14   | 2500 | 367.0       | 367.0      | 38.0        |
| TLV2434IPWR  | TSSOP        | PW              | 14   | 2000 | 367.0       | 367.0      | 35.0        |

JG (R-GDIP-T8)

CERAMIC DUAL-IN-LINE

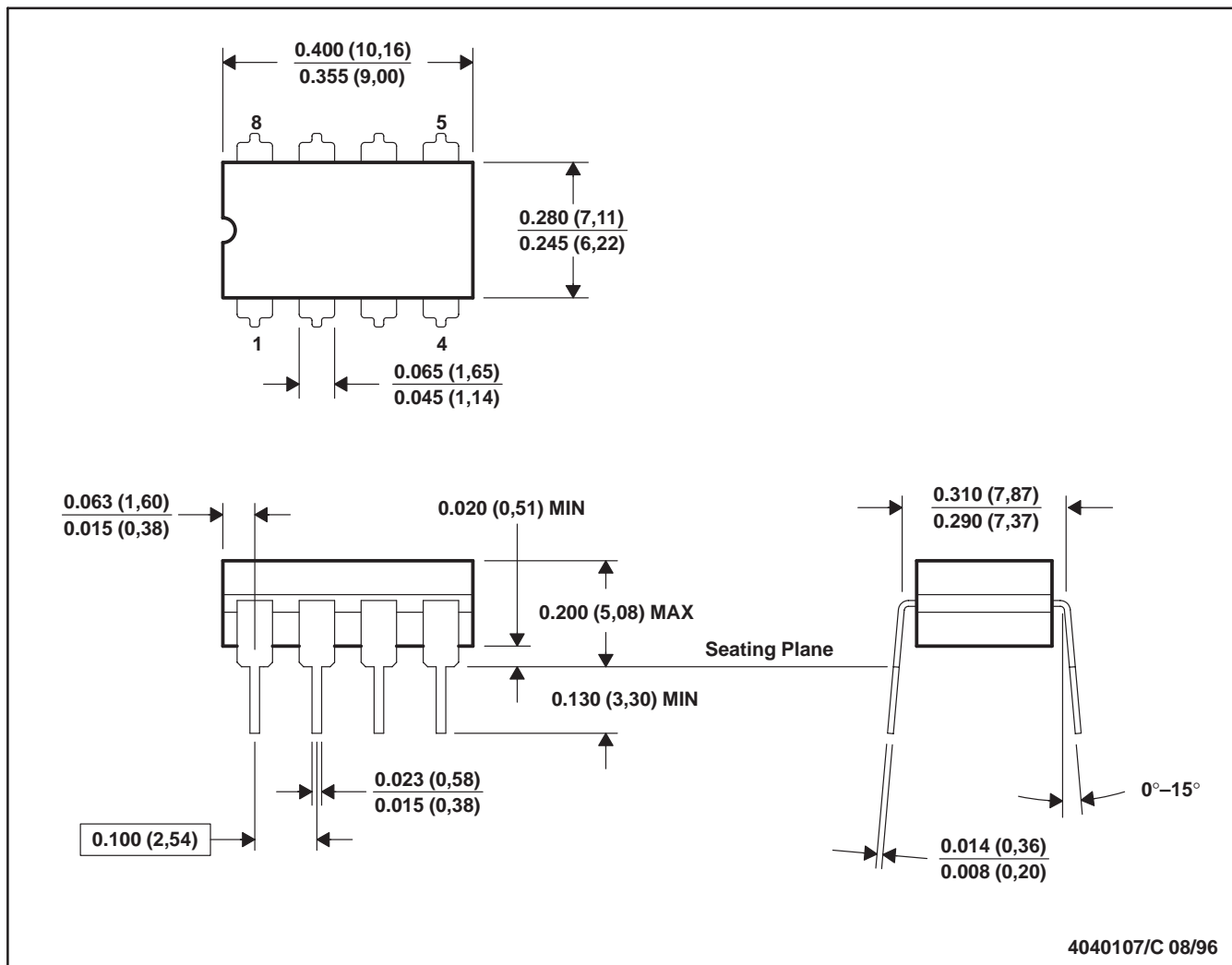

- NOTES: A. All linear dimensions are in inches (millimeters).  
 B. This drawing is subject to change without notice.  
 C. This package can be hermetically sealed with a ceramic lid using glass frit.  
 D. Index point is provided on cap for terminal identification.  
 E. Falls within MIL STD 1835 GDIP1-T8



FK (S-CQCC-N\*\*)

LEADLESS CERAMIC CHIP CARRIER

28 TERMINAL SHOWN

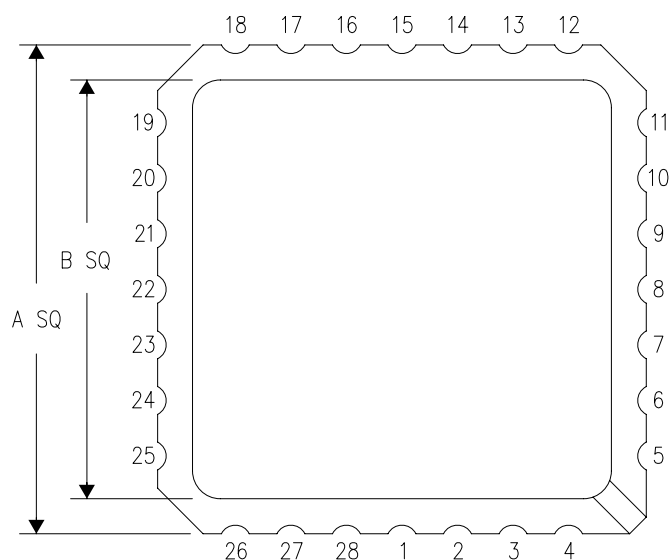

| NO. OF TERMINALS ** | A                |                  | B                |                  |
|---------------------|------------------|------------------|------------------|------------------|
|                     | MIN              | MAX              | MIN              | MAX              |
| 20                  | 0.342<br>(8,69)  | 0.358<br>(9,09)  | 0.307<br>(7,80)  | 0.358<br>(9,09)  |
| 28                  | 0.442<br>(11,23) | 0.458<br>(11,63) | 0.406<br>(10,31) | 0.458<br>(11,63) |
| 44                  | 0.640<br>(16,26) | 0.660<br>(16,76) | 0.495<br>(12,58) | 0.560<br>(14,22) |
| 52                  | 0.740<br>(18,78) | 0.761<br>(19,32) | 0.495<br>(12,58) | 0.560<br>(14,22) |
| 68                  | 0.938<br>(23,83) | 0.962<br>(24,43) | 0.850<br>(21,6)  | 0.858<br>(21,8)  |
| 84                  | 1.141<br>(28,99) | 1.165<br>(29,59) | 1.047<br>(26,6)  | 1.063<br>(27,0)  |

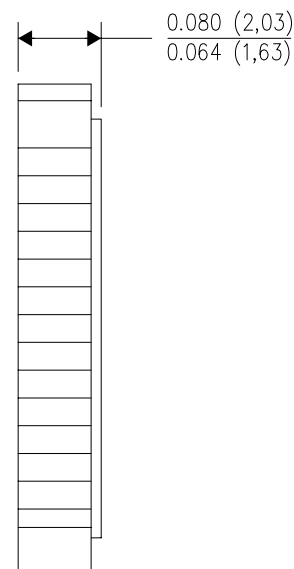
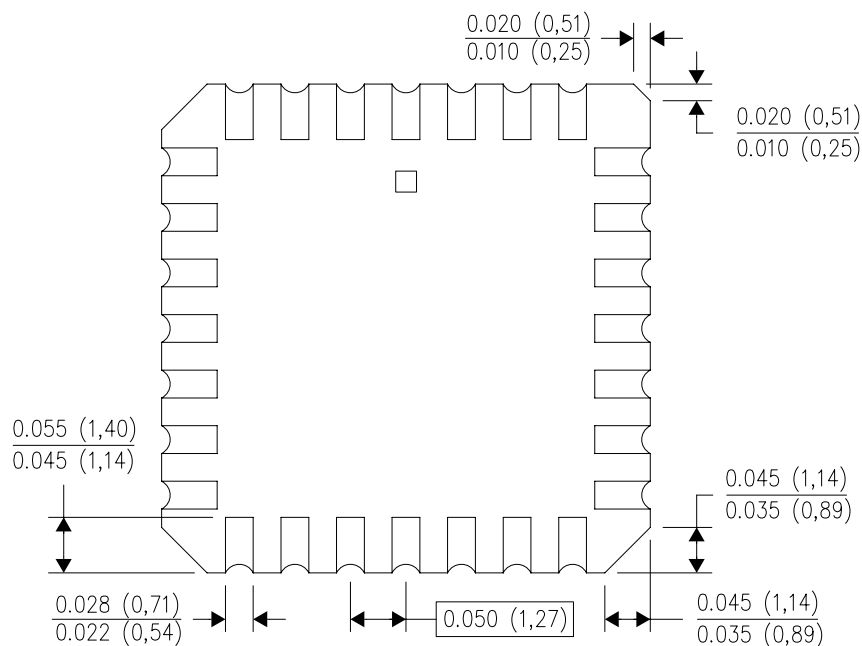

4040140/D 01/11

- NOTES:
- All linear dimensions are in inches (millimeters).
  - This drawing is subject to change without notice.
  - This package can be hermetically sealed with a metal lid.
  - Falls within JEDEC MS-004

D (R-PDSO-G14)

PLASTIC SMALL OUTLINE

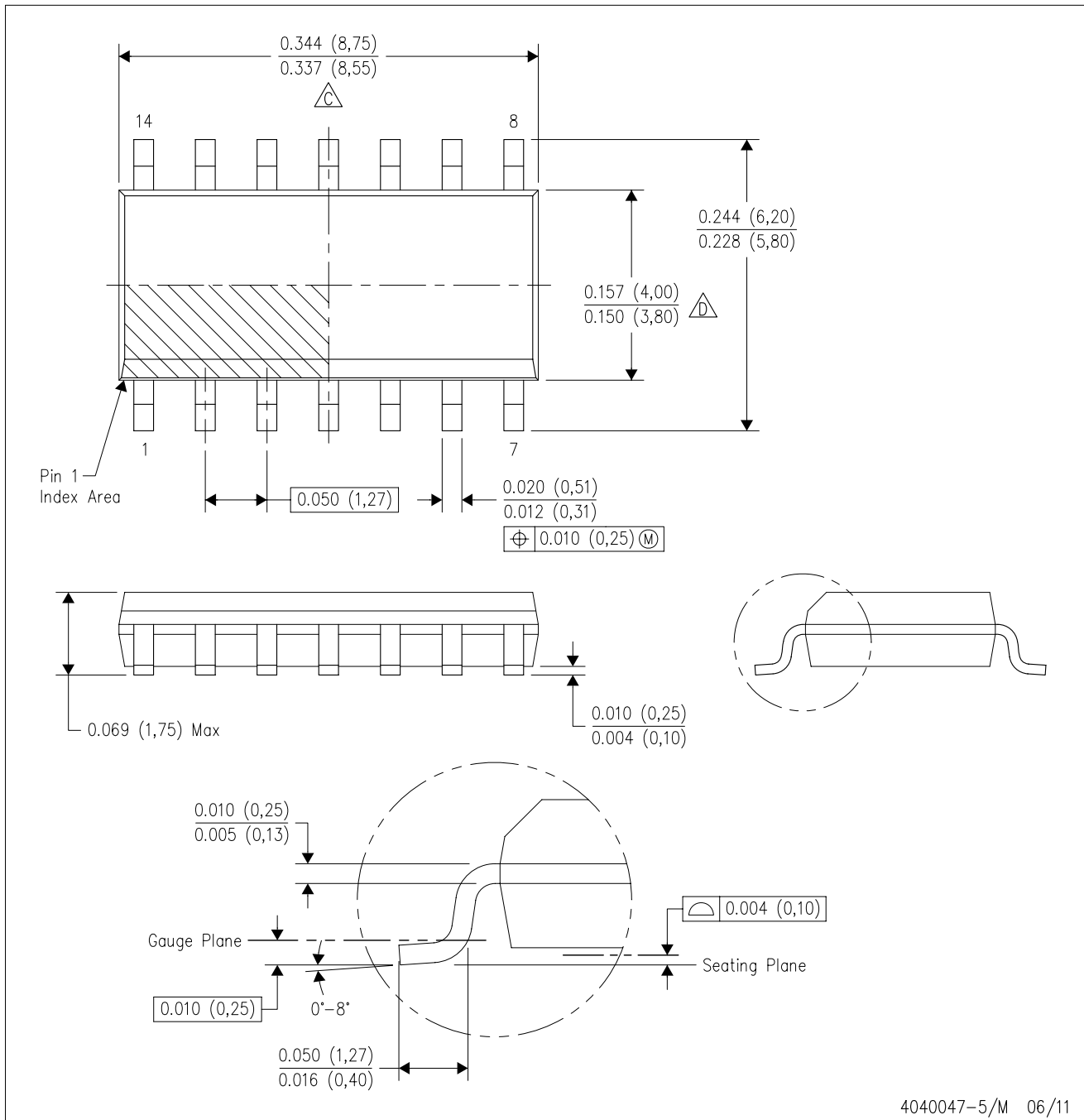

4040047-5/M 06/11

- NOTES:
- A. All linear dimensions are in inches (millimeters).
  - B. This drawing is subject to change without notice.
  - $\triangle C$  Body length does not include mold flash, protrusions, or gate burrs. Mold flash, protrusions, or gate burrs shall not exceed 0.006 (0,15) each side.
  - $\triangle D$  Body width does not include interlead flash. Interlead flash shall not exceed 0.017 (0,43) each side.
  - E. Reference JEDEC MS-012 variation AB.

D (R-PDSO-G14)

PLASTIC SMALL OUTLINE

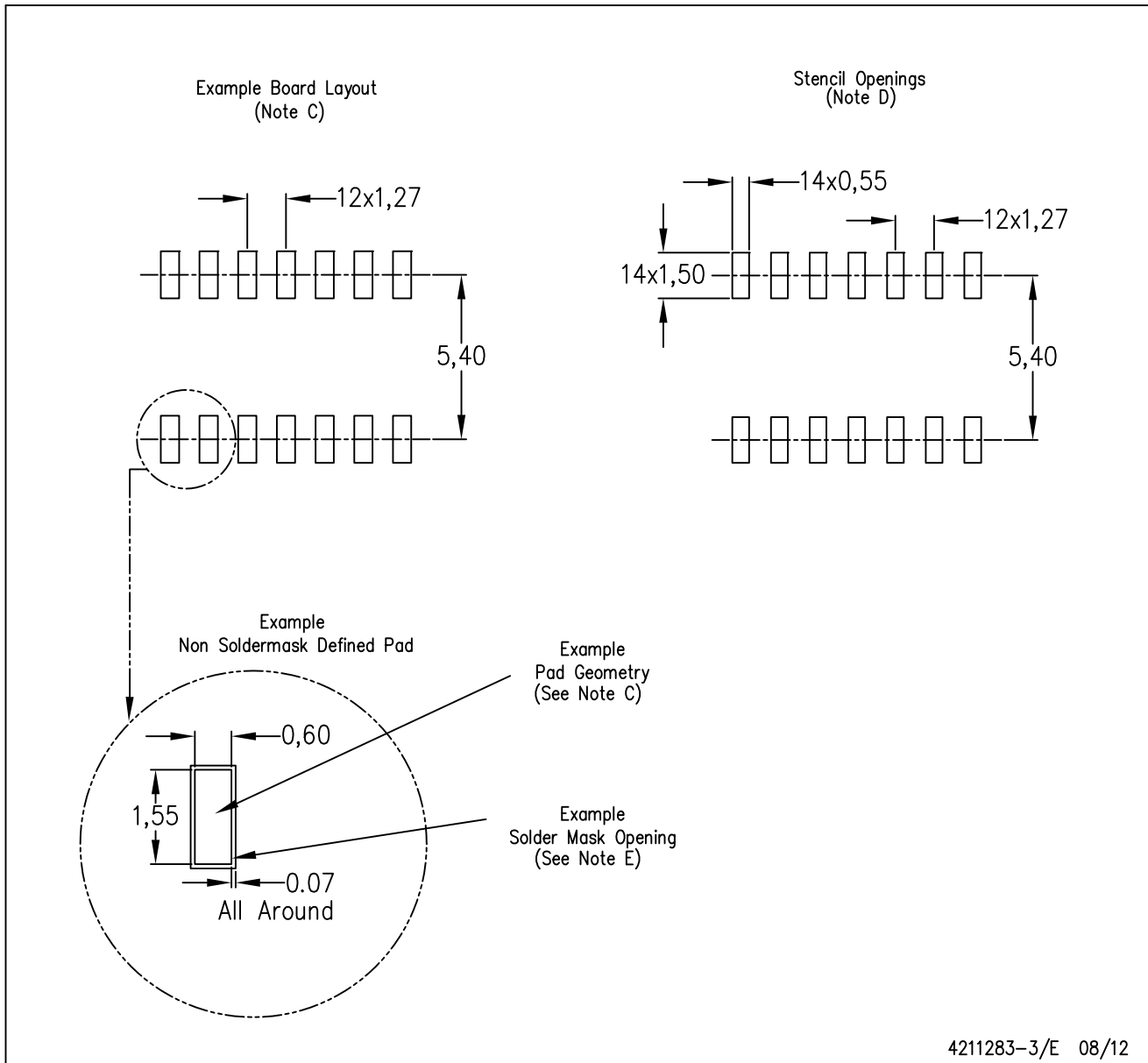

4211283-3/E 08/12

- NOTES:
- A. All linear dimensions are in millimeters.
  - B. This drawing is subject to change without notice.
  - C. Publication IPC-7351 is recommended for alternate designs.
  - D. Laser cutting apertures with trapezoidal walls and also rounding corners will offer better paste release. Customers should contact their board assembly site for stencil design recommendations. Refer to IPC-7525 for other stencil recommendations.
  - E. Customers should contact their board fabrication site for solder mask tolerances between and around signal pads.



PW (R-PDSO-G14)

PLASTIC SMALL OUTLINE



- NOTES:
- All linear dimensions are in millimeters.
  - This drawing is subject to change without notice.
  - Publication IPC-7351 is recommended for alternate designs.
  - Laser cutting apertures with trapezoidal walls and also rounding corners will offer better paste release. Customers should contact their board assembly site for stencil design recommendations. Refer to IPC-7525 for other stencil recommendations.
  - Customers should contact their board fabrication site for solder mask tolerances between and around signal pads.

PW0008A



**PACKAGE OUTLINE**  
**TSSOP - 1.2 mm max height**

SMALL OUTLINE PACKAGE

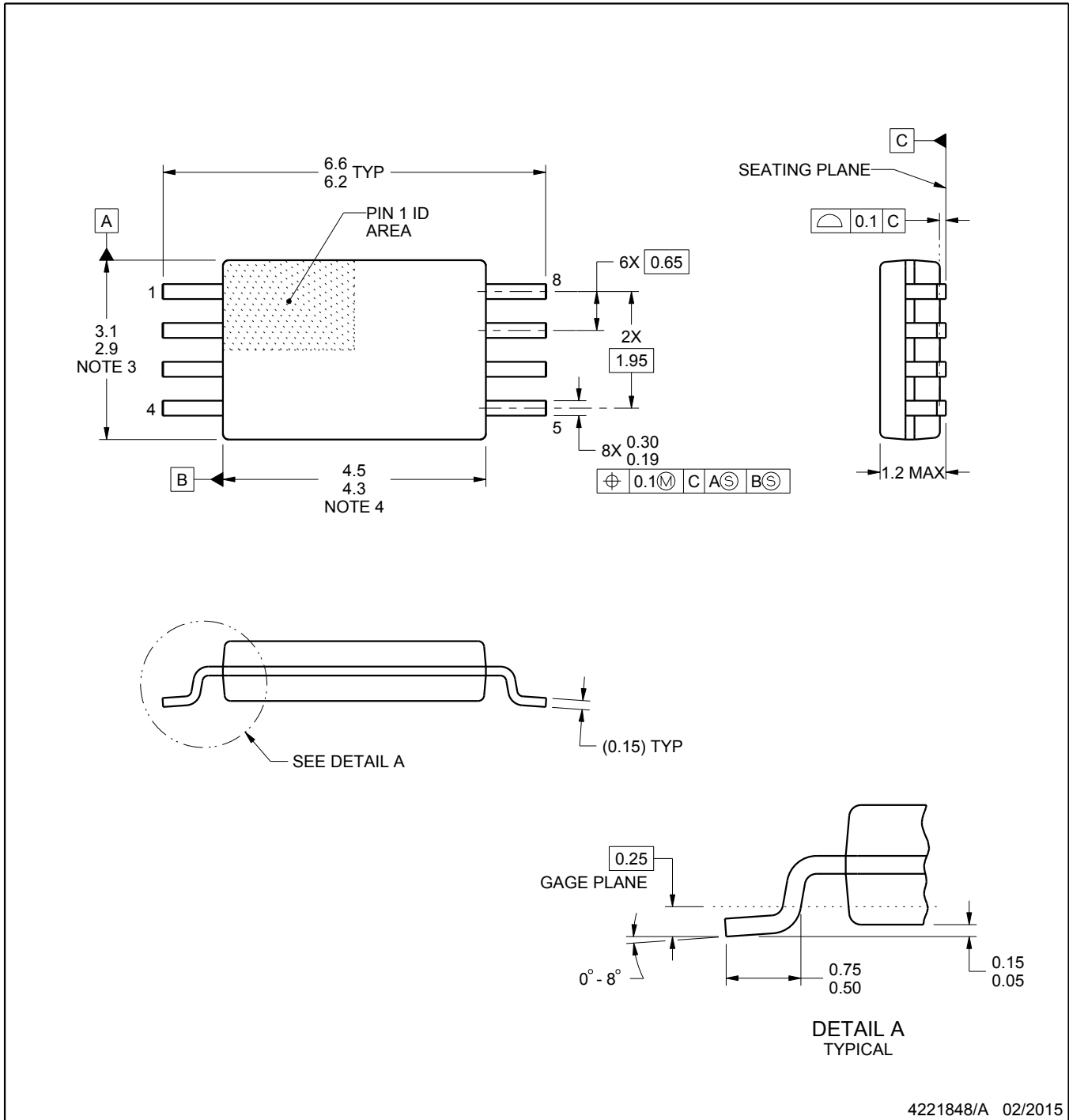

4221848/A 02/2015

NOTES:

1. All linear dimensions are in millimeters. Any dimensions in parenthesis are for reference only. Dimensioning and tolerancing per ASME Y14.5M.
2. This drawing is subject to change without notice.
3. This dimension does not include mold flash, protrusions, or gate burrs. Mold flash, protrusions, or gate burrs shall not exceed 0.15 mm per side.
4. This dimension does not include interlead flash. Interlead flash shall not exceed 0.25 mm per side.
5. Reference JEDEC registration MO-153, variation AA.

# EXAMPLE BOARD LAYOUT

PW0008A

TSSOP - 1.2 mm max height

SMALL OUTLINE PACKAGE



LAND PATTERN EXAMPLE  
SCALE:10X



SOLDER MASK DETAILS  
NOT TO SCALE

4221848/A 02/2015

NOTES: (continued)

- 6. Publication IPC-7351 may have alternate designs.
- 7. Solder mask tolerances between and around signal pads can vary based on board fabrication site.

# EXAMPLE STENCIL DESIGN

PW0008A

TSSOP - 1.2 mm max height

SMALL OUTLINE PACKAGE



SOLDER PASTE EXAMPLE  
BASED ON 0.125 mm THICK STENCIL  
SCALE:10X

4221848/A 02/2015

NOTES: (continued)

8. Laser cutting apertures with trapezoidal walls and rounded corners may offer better paste release. IPC-7525 may have alternate design recommendations.
9. Board assembly site may have different recommendations for stencil design.

D (R-PDSO-G8)

PLASTIC SMALL OUTLINE

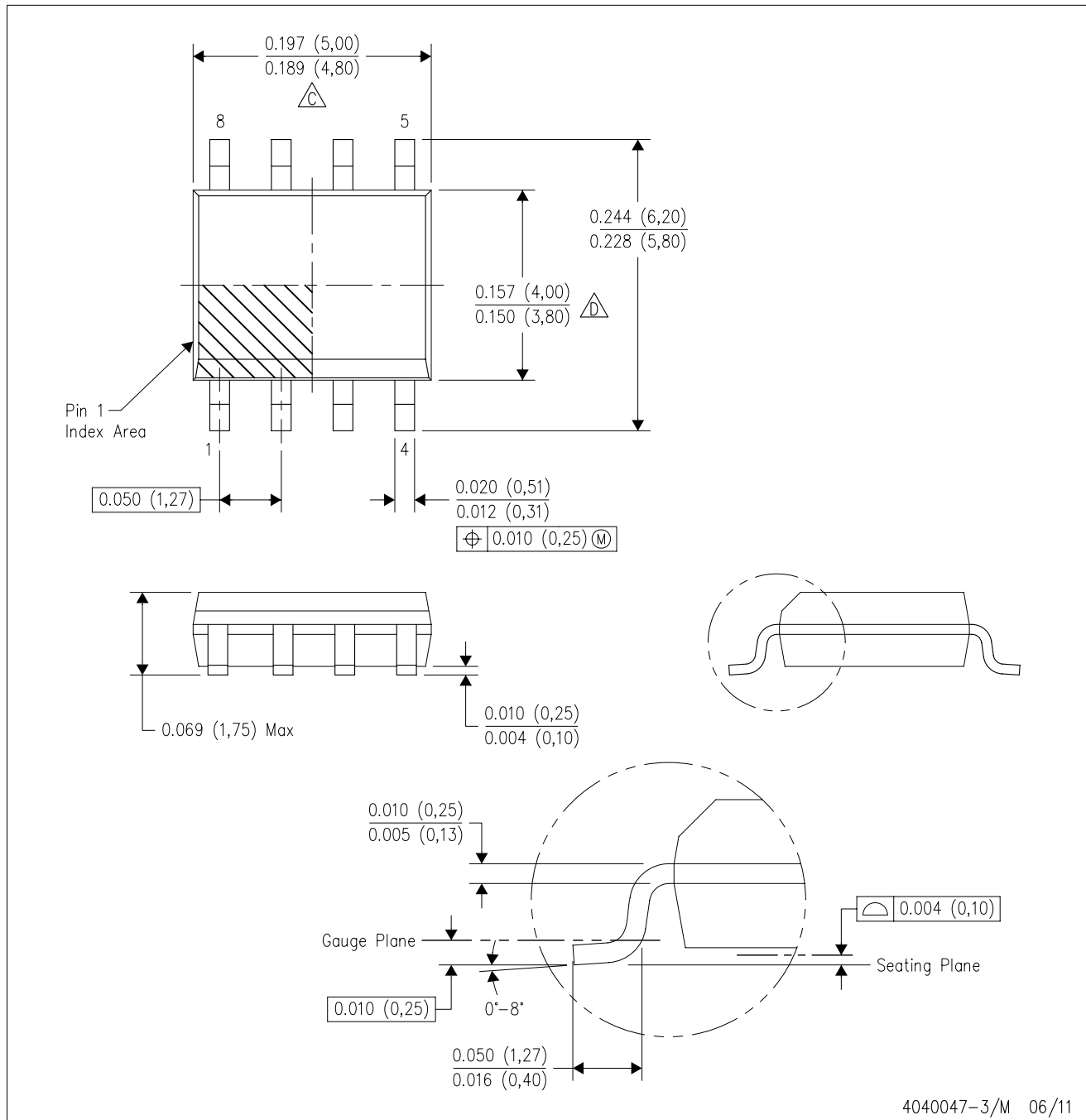

- NOTES:
- A. All linear dimensions are in inches (millimeters).
  - B. This drawing is subject to change without notice.
  - C. Body length does not include mold flash, protrusions, or gate burrs. Mold flash, protrusions, or gate burrs shall not exceed 0.006 (0,15) each side.
  - D. Body width does not include interlead flash. Interlead flash shall not exceed 0.017 (0,43) each side.
  - E. Reference JEDEC MS-012 variation AA.

D (R-PDSO-G8)

PLASTIC SMALL OUTLINE

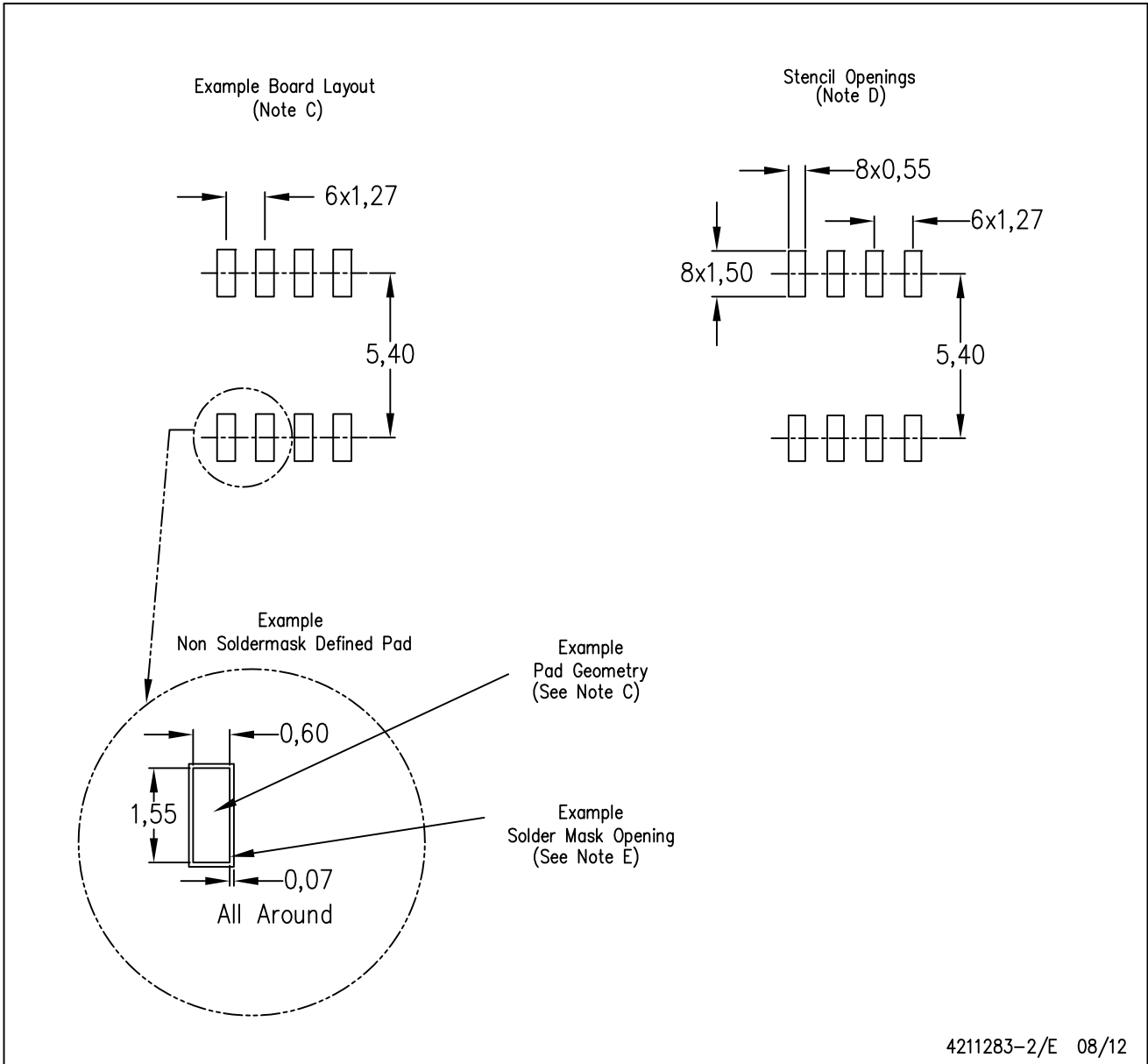

- NOTES:
- A. All linear dimensions are in millimeters.
  - B. This drawing is subject to change without notice.
  - C. Publication IPC-7351 is recommended for alternate designs.
  - D. Laser cutting apertures with trapezoidal walls and also rounding corners will offer better paste release. Customers should contact their board assembly site for stencil design recommendations. Refer to IPC-7525 for other stencil recommendations.
  - E. Customers should contact their board fabrication site for solder mask tolerances between and around signal pads.

## IMPORTANT NOTICE

Texas Instruments Incorporated and its subsidiaries (TI) reserve the right to make corrections, enhancements, improvements and other changes to its semiconductor products and services per JESD46, latest issue, and to discontinue any product or service per JESD48, latest issue. Buyers should obtain the latest relevant information before placing orders and should verify that such information is current and complete. All semiconductor products (also referred to herein as "components") are sold subject to TI's terms and conditions of sale supplied at the time of order acknowledgment.

TI warrants performance of its components to the specifications applicable at the time of sale, in accordance with the warranty in TI's terms and conditions of sale of semiconductor products. Testing and other quality control techniques are used to the extent TI deems necessary to support this warranty. Except where mandated by applicable law, testing of all parameters of each component is not necessarily performed.

TI assumes no liability for applications assistance or the design of Buyers' products. Buyers are responsible for their products and applications using TI components. To minimize the risks associated with Buyers' products and applications, Buyers should provide adequate design and operating safeguards.

TI does not warrant or represent that any license, either express or implied, is granted under any patent right, copyright, mask work right, or other intellectual property right relating to any combination, machine, or process in which TI components or services are used. Information published by TI regarding third-party products or services does not constitute a license to use such products or services or a warranty or endorsement thereof. Use of such information may require a license from a third party under the patents or other intellectual property of the third party, or a license from TI under the patents or other intellectual property of TI.

Reproduction of significant portions of TI information in TI data books or data sheets is permissible only if reproduction is without alteration and is accompanied by all associated warranties, conditions, limitations, and notices. TI is not responsible or liable for such altered documentation. Information of third parties may be subject to additional restrictions.

Resale of TI components or services with statements different from or beyond the parameters stated by TI for that component or service voids all express and any implied warranties for the associated TI component or service and is an unfair and deceptive business practice. TI is not responsible or liable for any such statements.

Buyer acknowledges and agrees that it is solely responsible for compliance with all legal, regulatory and safety-related requirements concerning its products, and any use of TI components in its applications, notwithstanding any applications-related information or support that may be provided by TI. Buyer represents and agrees that it has all the necessary expertise to create and implement safeguards which anticipate dangerous consequences of failures, monitor failures and their consequences, lessen the likelihood of failures that might cause harm and take appropriate remedial actions. Buyer will fully indemnify TI and its representatives against any damages arising out of the use of any TI components in safety-critical applications.

In some cases, TI components may be promoted specifically to facilitate safety-related applications. With such components, TI's goal is to help enable customers to design and create their own end-product solutions that meet applicable functional safety standards and requirements. Nonetheless, such components are subject to these terms.

No TI components are authorized for use in FDA Class III (or similar life-critical medical equipment) unless authorized officers of the parties have executed a special agreement specifically governing such use.

Only those TI components which TI has specifically designated as military grade or "enhanced plastic" are designed and intended for use in military/aerospace applications or environments. Buyer acknowledges and agrees that any military or aerospace use of TI components which have **not** been so designated is solely at the Buyer's risk, and that Buyer is solely responsible for compliance with all legal and regulatory requirements in connection with such use.

TI has specifically designated certain components as meeting ISO/TS16949 requirements, mainly for automotive use. In any case of use of non-designated products, TI will not be responsible for any failure to meet ISO/TS16949.

### Products

|                              |  |
|------------------------------|--|
| Audio                        | <a href="http://www.ti.com/audio">www.ti.com/audio</a>                               |
| Amplifiers                   | <a href="http://amplifier.ti.com">amplifier.ti.com</a>                               |
| Data Converters              | <a href="http://dataconverter.ti.com">dataconverter.ti.com</a>                       |
| DLP® Products                | <a href="http://www.dlp.com">www.dlp.com</a>   |
| DSP                          | <a href="http://dsp.ti.com">dsp.ti.com</a>   |
| Clocks and Timers            | <a href="http://www.ti.com/clocks">www.ti.com/clocks</a>                             |
| Interface                    | <a href="http://interface.ti.com">interface.ti.com</a>                               |
| Logic                        | <a href="http://logic.ti.com">logic.ti.com</a>                                       |
| Power Mgmt                   | <a href="http://power.ti.com">power.ti.com</a>                                       |
| Microcontrollers             | <a href="http://microcontroller.ti.com">microcontroller.ti.com</a>                   |
| RFID                         | <a href="http://www.ti-rfid.com">www.ti-rfid.com</a>                                 |
| OMAP Applications Processors | <a href="http://www.ti.com/omap">www.ti.com/omap</a>                                 |
| Wireless Connectivity        | <a href="http://www.ti.com/wirelessconnectivity">www.ti.com/wirelessconnectivity</a> |

### Applications

|                               |  |
|-------------------------------|--|
| Automotive and Transportation | <a href="http://www.ti.com/automotive">www.ti.com/automotive</a>                         |
| Communications and Telecom    | <a href="http://www.ti.com/communications">www.ti.com/communications</a>                 |
| Computers and Peripherals     | <a href="http://www.ti.com/computers">www.ti.com/computers</a>                           |
| Consumer Electronics          | <a href="http://www.ti.com/consumer-apps">www.ti.com/consumer-apps</a>                   |
| Energy and Lighting           | <a href="http://www.ti.com/energy">www.ti.com/energy</a>                                 |
| Industrial                    | <a href="http://www.ti.com/industrial">www.ti.com/industrial</a>                         |
| Medical                       | <a href="http://www.ti.com/medical">www.ti.com/medical</a>                               |
| Security                      | <a href="http://www.ti.com/security">www.ti.com/security</a>                             |
| Space, Avionics and Defense   | <a href="http://www.ti.com/space-avionics-defense">www.ti.com/space-avionics-defense</a> |
| Video and Imaging             | <a href="http://www.ti.com/video">www.ti.com/video</a>                                   |

### TI E2E Community

[e2e.ti.com](http://e2e.ti.com)