

## Advanced LinCMOS™ RAIL-TO-RAIL OUTPUT WIDE-INPUT-VOLTAGE OPERATIONAL AMPLIFIERS

### FEATURES

- Qualified for Automotive Applications
- ESD Protection Exceeds 2000 V Per MIL-STD-883, Method 3015; Exceeds 200 V Using Machine Model (C = 200 pF, R = 0)
- Output Swing Includes Both Supply Rails
- Extended Common-Mode Input Voltage Range: 0 V to 4.25 V (Min) at 5-V Single Supply
- No Phase Inversion
- Low Noise: 16 nV/√Hz Typ at f = 1 kHz
- Low Input Offset Voltage: 950 μV Max at T<sub>A</sub> = 25°C (TLV244xA)
- Low Input Bias Current: 1 pA (Typ)
- 600-Ω Output Drive
- High-Gain Bandwidth: 1.8 MHz (Typ)
- Low Supply Current: 750 μA Per Channel (Typ)
- Macromodel Included

### DESCRIPTION

The TLV244x and TLV244xA are low-voltage operational amplifiers from Texas Instruments. The common-mode input voltage range of these devices has been extended over typical standard CMOS amplifiers, making them suitable for a wide range of applications. In addition, these devices do not phase invert when the common-mode input is driven to the supply rails. This satisfies most design requirements without paying a premium for rail-to-rail input performance. They also exhibit rail-to-rail output performance for increased dynamic range in single- or split-supply applications. This family is fully characterized at 3-V and 5-V supplies and is optimized for low-voltage operation. Both devices offer comparable ac performance while having lower noise, input offset voltage, and power dissipation than existing CMOS operational amplifiers. The TLV244x has increased output drive over previous rail-to-rail operational amplifiers and can drive 600-Ω loads for telecommunications applications.

The other members in the TLV244x family are the low-power, TLV243x, and micro-power, TLV2422, versions.

The TLV244x, exhibiting high input impedance and low noise, is excellent for small-signal conditioning for high-impedance sources, such as piezoelectric transducers. Because of the micropower dissipation levels and low-voltage operation, these devices work well in hand-held monitoring and remote-sensing applications. In addition, the rail-to-rail output feature with single- or split-supplies makes this family a great choice when interfacing with analog-to-digital converters (ADCs). For precision applications, the TLV244xA is available with a maximum input offset voltage of 950 μV.

If the design requires single operational amplifiers, see the TI TLV2211/21/31. This is a family of rail-to-rail output operational amplifiers in the SOT-23 package. Their small size and low power consumption make them ideal for high-density battery-powered equipment.

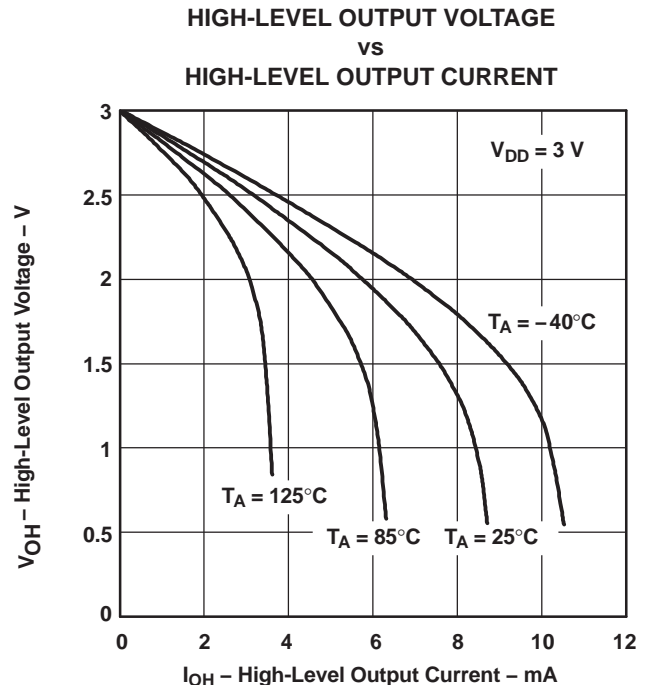

Figure 1.



Please be aware that an important notice concerning availability, standard warranty, and use in critical applications of Texas Instruments semiconductor products and disclaimers thereto appears at the end of this data sheet.

Advanced LinCMOS is a trademark of Texas Instruments.  
PSPICE, Parts are trademarks of MicroSim.

**ORDERING INFORMATION<sup>(1)</sup>**

T <sub>A</sub>	V <sub>IO</sub> max AT 25 = C	PACKAGE <sup>(2)</sup>			ORDERABLE PART NUMBER	TOP-SIDE MARKING
-40°C to 125°C	950 μV	Dual	SOIC – D	Reel of 2500	TLV2442AQDRQ1	2442AQ
			TSSOP – PW	Reel of 2000	TLV2442AQPWRQ1	2442AQ
	2.5 mV	Dual	MSOP – DGK	Reel of 2500	TLV2442QDQKRQ1	OBR
			SOIC – D	Reel of 2500	TLV2442QDRQ1	2442Q1
			TSSOP – PW	Reel of 2000	TLV2442QPWRQ1	2442Q1
	950 μV	Quad	TSSOP – PW	Reel of 2000	TLV2444AQPWRQ1	2444AQ

- (1) For the most current package and ordering information, see the Package Option Addendum at the end of this document, or see the TI web site at [www.ti.com](http://www.ti.com).  
 (2) Package drawings, thermal data, and symbolization are available at [www.ti.com/packaging](http://www.ti.com/packaging).

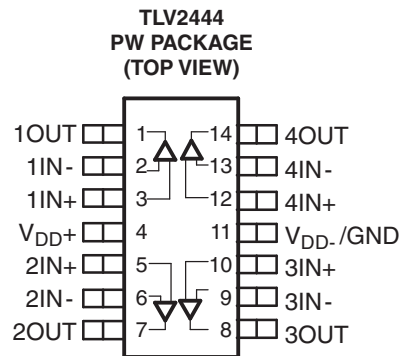
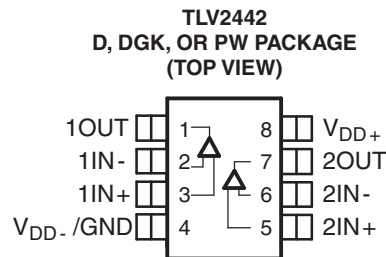

EQUIVALENT SCHEMATIC (EACH AMPLIFIER)

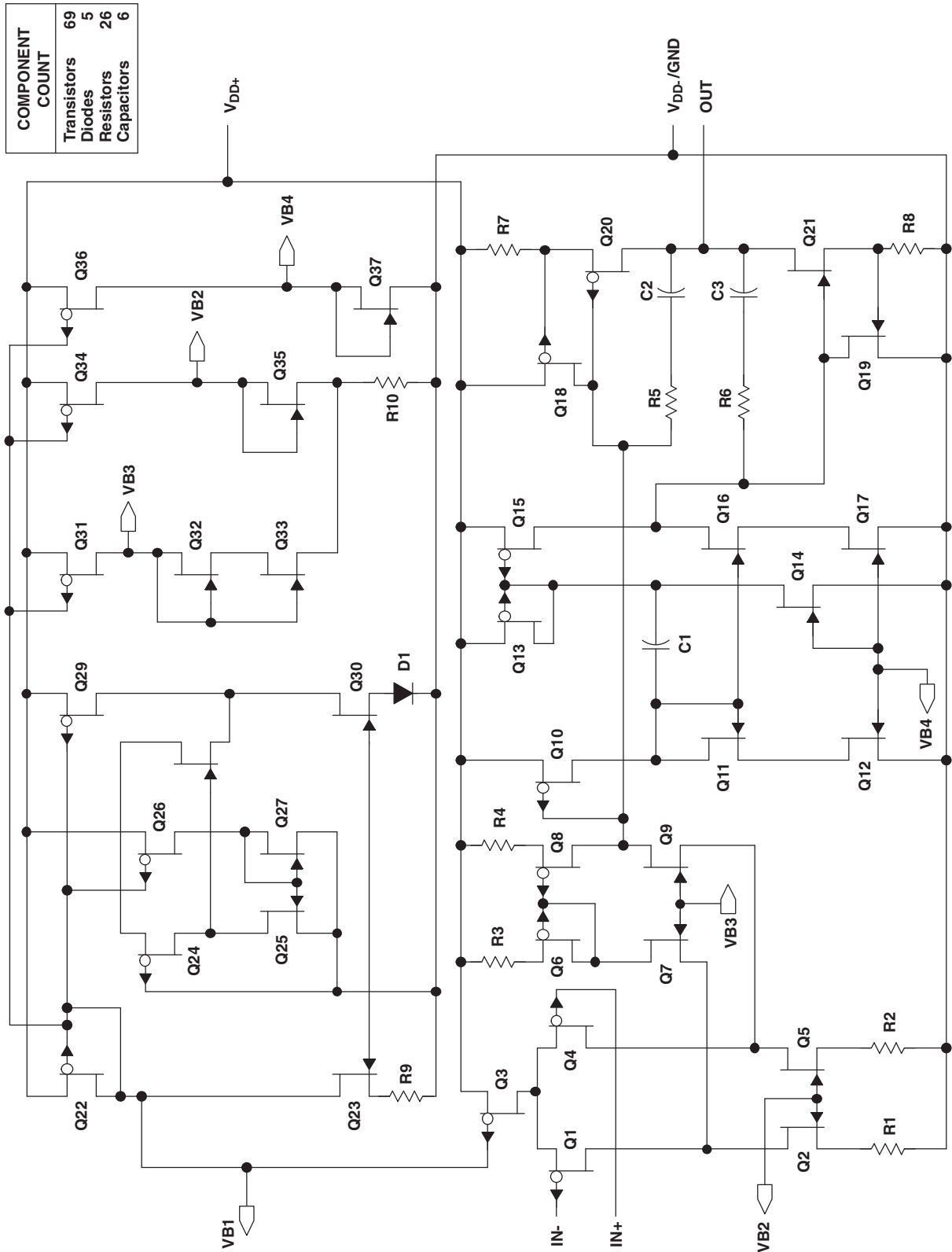

COMPONENT COUNT	
Transistors	69
Diodes	5
Resistors	26
Capacitors	6

## ABSOLUTE MAXIMUM RATINGS<sup>(1)</sup>

over operating free-air temperature range (unless otherwise noted)

$V_{DD}$	Supply voltage <sup>(2)</sup>	12 V
$V_{ID}$	Differential input voltage <sup>(3)</sup>	$\pm V_{DD}$
$V_I$	Input voltage (any input) <sup>(2)</sup>	-0.3 V to $V_{DD}$
$I_I$	Input current (any input)	$\pm 5$ mA
$I_O$	Output current	$\pm 50$ mA
	Total current into $V_{DD+}$	$\pm 50$ mA
	Total current out of $V_{DD-}$	$\pm 50$ mA
	Duration of short-circuit current at (or below) $25 = C$ <sup>(4)</sup>	Unlimited
	Continuous total dissipation	See Dissipation Rating Table
$T_A$	Operating free-air temperature range	-40°C to 125°C
$T_{stg}$	Storage temperature range	-65°C to 150°C
	Lead temperature 1,6 mm (1/16 inch) from case for 10 seconds	260°C

- (1) Stresses beyond those listed under *absolute maximum ratings* may cause permanent damage to the device. These are stress ratings only, and functional operation of the device at these or any other conditions beyond those indicated under *recommended operating conditions* is not implied. Exposure to absolute-maximum-rated conditions for extended periods may affect device reliability.
- (2) All voltage values, except differential voltages, are with respect to the midpoint between  $V_{DD+}$  and  $V_{DD-}$ .
- (3) Differential voltages are at  $IN+$  with respect to  $IN-$ . Excessive current will flow if input is brought below  $V_{DD-} - 0.3$  V.
- (4) The output may be shorted to either supply. Temperature and/or supply voltages must be limited to ensure that the maximum dissipation rating is not exceeded.

## DISSIPATION RATINGS

PACKAGE	$T_A \leq 25^\circ\text{C}$ POWER RATING	DERATING FACTOR ABOVE $T_A = 25^\circ\text{C}$	$T_A = 70^\circ\text{C}$ POWER RATING	$T_A = 85^\circ\text{C}$ POWER RATING	$T_A = 125^\circ\text{C}$ POWER RATING
D (8 pin)	725 mW	5.8 mW/°C	464 mW	377 mW	145 mW
DGK (8 pin)	606 mW	4.847 mW/°C	388 mW	315 mW	121 mW
PW (8 pin)	525 mW	4.2 mW/°C	336 mW	273 mW	105 mW
PW (14 pin)	720 mW	5.6 mW/°C	634 mW	547 mW	317 mW

## RECOMMENDED OPERATING CONDITIONS

		MIN	MAX	UNIT
$V_{DD}$	Supply voltage	2.7	10	V
$V_I$	Input voltage	$V_{DD-}$	$V_{DD+} - 1$	V
$V_{IC}$	Common-mode input voltage	$V_{DD-}$	$V_{DD+} - 1$	V
$T_A$	Operating free-air temperature	-40	125	°C

## ELECTRICAL CHARACTERISTICS

 $V_{DD} = 3\text{ V}$ , at specified free-air temperature (unless otherwise noted)

PARAMETER	TEST CONDITIONS	$T_A$ <sup>(1)</sup>	MIN	TYP	MAX	UNIT
$V_{IO}$ Input offset voltage	$V_{IC} = 1.5\text{ V}$ , $V_O = 1.5\text{ V}$ , $R_S = 50\ \Omega$	TLV244x	25°C	300	2000	$\mu\text{V}$
			Full range		2500	
		TLV244xA	25°C	300	950	
			Full range		1600	
$\alpha_{VIO}$ Temperature coefficient of input offset voltage	$V_{IC} = 1.5\text{ V}$ , $V_O = 1.5\text{ V}$ , $R_S = 50\ \Omega$	25°C to 85°C		2		$\mu\text{V}/^\circ\text{C}$
Input offset voltage long-term drift <sup>(2)</sup>	$V_{IC} = 1.5\text{ V}$ , $V_O = 1.5\text{ V}$ , $R_S = 50\ \Omega$	25°C		0.002		$\mu\text{V}/\text{mo}$
$I_{IO}$ Input offset current	$V_{IC} = 1.5\text{ V}$ , $V_O = 1.5\text{ V}$ , $R_S = 50\ \Omega$	25°C		0.5		$\text{pA}$
		Full range			150	
$I_{IB}$ Input bias current	$V_{IC} = 1.5\text{ V}$ , $V_O = 1.5\text{ V}$ , $R_S = 50\ \Omega$	25°C		1		$\text{pA}$
		Full range			260	
$V_{ICR}$ Common-mode input voltage range	$ V_{IO}  \leq 8\text{ mV}$ , $R_S = 50\ \Omega$	25°C	0 to 2.25	-0.25 to 2.5		$\text{V}$
		Full range	0.2 to 2			
$V_{OH}$ High-level output voltage	$I_O = -100\ \mu\text{A}$	25°C		2.98		$\text{V}$
	$I_O = -3\text{ mA}$	25°C		2.5		
	Full range		2.25			
$V_{OL}$ Low-level output voltage	$V_{IC} = 1.5\text{ V}$	$I_O = 100\ \mu\text{A}$	25°C	0.02		$\text{V}$
		$I_O = 3\text{ mA}$	25°C	0.63		
		Full range			1	
$A_{VD}$ Large-signal differential voltage amplification	$V_O = 1\text{ V to }2\text{ V}$	$R_L = 600\ \Omega$	25°C	0.7	1	$\text{V}/\text{mV}$
			Full range	0.4		
		$R_L = 1\text{ M}\Omega$	25°C		750	
$r_{id}$ Differential input resistance		25°C		1000		$\text{G}\Omega$
$r_i$ Common-mode input resistance		25°C		1000		$\text{G}\Omega$
$c_i$ Common-mode input capacitance	$f = 10\text{ kHz}$	25°C		8		$\text{pF}$
$z_o$ Closed-loop output impedance	$f = 1\text{ MHz}$ , $A_V = 10$	25°C		130		$\Omega$
CMRR Common-mode rejection ratio	$V_{IC} = V_{ICR\text{ MIN}}$ , $V_O = V_{DD}/2$ , $R_S = 50\ \Omega$	25°C	65	75		$\text{dB}$
		Full range	50			
$k_{SVR}$ Supply-voltage rejection ratio ( $\Delta V_{DD\pm}/\Delta V_{IO}$ )	$V_{DD} = 2.7\text{ V to }8\text{ V}$ , $V_{IC} = V_{DD}/2$ , No load	25°C	80	95		$\text{dB}$
		Full range	80			
$I_{DD}$ Supply current (per channel)	$V_O = 1.5\text{ V}$ , No load	25°C		725	1100	$\mu\text{A}$
		Full range			1100	

(1) Full range is  $-40^\circ\text{C}$  to  $125^\circ\text{C}$ .

(2) Typical values are based on the input offset voltage shift observed through 168 hours of operating life test at  $T_A = 150^\circ\text{C}$  extrapolated to  $T_A = 25^\circ\text{C}$  using the Arrhenius equation and assuming an activation energy of 0.96 eV.

## OPERATING CHARACTERISTICS

$V_{DD} = 3\text{ V}$ , at specified free-air temperature (unless otherwise noted)

PARAMETER		TEST CONDITIONS		$T_A^{(1)}$	MIN	TYP	MAX	UNIT
SR	Slew rate at unity gain	$V_O = 1\text{ V to }2\text{ V}$ , $R_L = 600\ \Omega$ , $C_L = 100\text{ pF}$		25°C	0.65	1.3		V/ $\mu\text{s}$
				Full range	0.4			
$V_n$	Equivalent input noise voltage			25°C	170			nV/ $\sqrt{\text{Hz}}$
					18			
$V_{n(PP)}$	Peak-to-peak equivalent input noise voltage	$f = 0.1\text{ Hz to }1\text{ Hz}$ $f = 0.1\text{ Hz to }10\text{ Hz}$		25°C	2.6			$\mu\text{V}$
					5.1			
$I_n$	Equivalent input noise current			25°C	0.6			fA/ $\sqrt{\text{Hz}}$
THD+N	Total harmonic distortion plus noise	$V_O = 0.5\text{ V to }2.5\text{ V}$ , $R_L = 600\ \Omega$ , $f = 1\text{ kHz}$		25°C	$A_V = 1$			%
					$A_V = 10$			
					$A_V = 100$			
	Gain-bandwidth product	$f = 10\text{ kHz}$ , $R_L = 600\ \Omega$ , $C_L = 100\text{ pF}$		25°C	1.75			MHz
BOM	Maximum output-swing bandwidth	$V_{O(PP)} = 1\text{ V}$ , $R_L = 600\ \Omega$ , $A_V = 1$ , $C_L = 100\text{ pF}$		25°C	0.9			MHz
$t_s$	Settling time	$A_V = -1$ , Step = $-2.3\text{ V to }2.3\text{ V}$ , $R_L = 600\ \Omega$ , $C_L = 100\text{ pF}$		25°C	To 0.1%			$\mu\text{s}$
					To 0.01%			
$\phi_m$	Phase margin at unity gain	$R_L = 600\ \Omega$ , $C_L = 100\text{ pF}$		25°C	65			°
	Gain margin	$R_L = 600\ \Omega$ , $C_L = 100\text{ pF}$		25°C	9			dB

(1) Full range is  $-40^\circ\text{C}$  to  $125^\circ\text{C}$ .

## ELECTRICAL CHARACTERISTICS

 $V_{DD} = 5\text{ V}$ , at specified free-air temperature (unless otherwise noted)

PARAMETER	TEST CONDITIONS	$T_A$ <sup>(1)</sup>	MIN	TYP	MAX	UNIT
$V_{IO}$ Input offset voltage	$V_{DD\pm} = \pm 2.5\text{ V}$ , $V_{IC} = 0$ , $V_O = 0$ , $R_S = 50\ \Omega$	TLV244x	25°C	300	2000	$\mu\text{V}$
			Full range		2500	
		TLV244xA	25°C	300	950	
			Full range		1600	
$\alpha_{VIO}$ Temperature coefficient of input offset voltage	$V_{DD\pm} = \pm 2.5\text{ V}$ , $V_{IC} = 0$ , $V_O = 0$ , $R_S = 50\ \Omega$	25°C to 85°C		2		$\mu\text{V}/^\circ\text{C}$
Input offset voltage long-term drift <sup>(2)</sup>	$V_{DD\pm} = \pm 2.5\text{ V}$ , $V_{IC} = 0$ , $V_O = 0$ , $R_S = 50\ \Omega$	25°C		0.002		$\mu\text{V}/\text{mo}$
$I_{IO}$ Input offset current	$V_{DD\pm} = \pm 2.5\text{ V}$ , $V_{IC} = 0$ , $V_O = 0$ , $R_S = 50\ \Omega$	25°C		0.5		$\text{pA}$
		Full range			150	
$I_{IB}$ Input bias current	$V_{DD\pm} = \pm 2.5\text{ V}$ , $V_{IC} = 0$ , $V_O = 0$ , $R_S = 50\ \Omega$	25°C		1		$\text{pA}$
		Full range			260	
$V_{ICR}$ Common-mode input voltage range	$ V_{IO}  \leq 5\text{ mV}$ , $R_S = 50\ \Omega$	25°C	0 to 4.25	-0.25 to 4.5		$\text{V}$
		Full range	0 to 4			
$V_{OH}$ High-level output voltage	$I_{OH} = -100\ \mu\text{A}$ $I_{OH} = -5\text{ mA}$	25°C		4.97		$\text{V}$
		25°C		4	4.35	
		Full range		4		
$V_{OL}$ Low-level output voltage	$V_{IC} = 2.5\text{ V}$	$I_{OL} = 100\ \mu\text{A}$	25°C		0.01	$\text{V}$
		$I_{OL} = 5\text{ mA}$	25°C		0.8	
			Full range			
$A_{VD}$ Large-signal differential voltage amplification	$V_{IC} = 2.5\text{ V}$ , $V_O = 1\text{ V to }4\text{ V}$	$R_L = 600\ \Omega$ <sup>(3)</sup>	25°C	0.9	1.3	$\text{V/mV}$
			Full range		0.5	
		$R_L = 1\text{ M}\Omega$ <sup>(3)</sup>	25°C		950	
$r_{id}$ Differential input resistance		25°C		1000		$\text{G}\Omega$
$r_i$ Common-mode input resistance		25°C		1000		$\text{G}\Omega$
$c_i$ Common-mode input capacitance	$f = 10\text{ kHz}$	25°C		8		$\text{pF}$
$z_o$ Closed-loop output impedance	$f = 1\text{ MHz}$ , $A_V = 10$	25°C		140		$\Omega$
CMRR Common-mode rejection ratio	$V_{IC} = V_{ICR\text{ MIN}}$ , $V_O = V_{DD}/2$ , $R_S = 50\ \Omega$	25°C	70	75		$\text{dB}$
		Full range	70			
$k_{SVR}$ Supply-voltage rejection ratio ( $\Delta V_{DD}/\Delta V_{IO}$ )	$V_{DD} = 4.4\text{ V to }8\text{ V}$ , $V_{IC} = V_{DD}/2$ , No load	25°C	80	95		$\text{dB}$
		Full range	80			
$I_{DD}$ Supply current (per channel)	$V_O = 2.5\text{ V}$ , No load	25°C		750	1100	$\mu\text{A}$
		Full range			1100	

(1) Full range is  $-40^\circ\text{C}$  to  $125^\circ\text{C}$ .

(2) Typical values are based on the input offset voltage shift observed through 168 hours of operating life test at  $T_A = 150^\circ\text{C}$  extrapolated to  $T_A = 25^\circ\text{C}$  using the Arrhenius equation and assuming an activation energy of 0.96 eV.

(3) Referenced to 2.5 V

## OPERATING CHARACTERISTICS

$V_{DD} = 5\text{ V}$ , at specified free-air temperature (unless otherwise noted)

PARAMETER		TEST CONDITIONS		$T_A^{(1)}$	MIN	TYP	MAX	UNIT
SR	Slew rate at unity gain	$V_O = 0.5\text{ V to } 2.5\text{ V}$ , $R_L = 600\ \Omega^{(2)}$ , $C_L = 100\text{ pF}^{(2)}$		25°C	0.75	1.4		V/ $\mu\text{s}$
				Full range	0.5			
$V_n$	Equivalent input noise voltage			25°C	130			nV/ $\sqrt{\text{Hz}}$
					16			
$V_{n(PP)}$	Peak-to-peak equivalent input noise voltage	$f = 0.1\text{ Hz to } 1\text{ Hz}$ $f = 0.1\text{ Hz to } 10\text{ Hz}$		25°C	1.8			$\mu\text{V}$
					3.6			
$I_n$	Equivalent input noise current			25°C	0.6		fA/ $\sqrt{\text{Hz}}$	
THD+N	Total harmonic distortion plus noise	$V_O = 1.5\text{ V to } 3.5\text{ V}$ , $f = 1\text{ kHz}$ , $R_L = 600\ \Omega^{(2)}$		25°C	$A_V = 1$			%
					$A_V = 10$			
					$A_V = 100$			
Gain-bandwidth product		$f = 10\text{ kHz}$ , $R_L = 600\ \Omega^{(2)}$ , $C_L = 100\text{ pF}^{(2)}$		25°C	1.81		MHz	
BOM	Maximum output-swing bandwidth	$V_{O(PP)} = 2\text{ V}$ , $A_V = 1$ , $R_L = 600\ \Omega^{(2)}$ , $C_L = 100\text{ pF}^{(2)}$		25°C	0.5		MHz	
$t_s$	Settling time	$A_V = -1$ , Step = $-0.5\text{ V to } 2.5\text{ V}$ , $R_L = 600\ \Omega^{(2)}$ , $C_L = 100\text{ pF}^{(2)}$		25°C	To 0.1%			$\mu\text{s}$
					To 0.01%			
$\phi_m$	Phase margin at unity gain	$R_L = 600\ \Omega^{(2)}$ , $C_L = 100\text{ pF}^{(2)}$		25°C	68		°	
	Gain margin	$R_L = 600\ \Omega^{(2)}$ , $C_L = 100\text{ pF}^{(2)}$		25°C	8		dB	

(1) Full range is  $-40^\circ\text{C}$  to  $125^\circ\text{C}$ .

(2) Referenced to 2.5 V

## TYPICAL CHARACTERISTICS

### Table of Graphs<sup>(1)</sup>

			FIGURE
$V_{IO}$	Input offset voltage	Distribution	2, 3
		vs Common-mode input voltage	4, 5
$\alpha_{VIO}$	Input offset voltage temperature coefficient	Distribution	6, 7
$I_B/I_{IO}$	Input bias and input offset currents	vs Free-air temperature	8
$V_{OH}$	High-level output voltage	vs High-level output current	9, 10
$V_{OL}$	Low-level output voltage	vs Low-level output current	11, 12
$V_{O(PP)}$	Maximum peak-to-peak output voltage	vs Frequency	13
$I_{OS}$	Short-circuit output current	vs Supply voltage	14
		vs Free-air temperature	15
$V_O$	Output voltage	vs Differential input voltage	16, 17
$A_{VD}$	Differential voltage amplification	vs Load resistance	18
	Large-signal differential voltage amplification and phase margin	vs Frequency	19, 20
	Large-signal differential voltage amplification	vs Free-air temperature	21, 22
$Z_o$	Output impedance	vs Frequency	23, 24
CMRR	Common-mode rejection ratio	vs Frequency	25
		vs Free-air temperature	26
$k_{SVR}$	Supply-voltage rejection ratio	vs Frequency	27, 28
		vs Free-air temperature	29
$I_{DD}$	Supply current	vs Supply voltage	30
SR	Slew rate	vs Load capacitance	31
		vs Free-air temperature	32
$V_O$	Inverting large-signal pulse response		33, 34
	Voltage-follower large-signal pulse response		35, 36
	Inverting small-signal pulse response		37, 38
	Voltage-follower small-signal pulse response		39, 40
$V_n$	Equivalent input noise voltage	vs Frequency	41, 42
	Noise voltage	Over a 10-second period	43
THD + N	Total harmonic distortion plus noise	vs Frequency	44, 45
		vs Free-air temperature	46
		vs Supply voltage	47
$\phi_m$	Phase margin	vs Frequency	19, 20
		vs Load capacitance	48
	Gain margin	vs Load capacitance	49
$B_1$	Unity-gain bandwidth	vs Load capacitance	50

(1) For all graphs where  $V_{DD} = 5\text{ V}$ , all loads are referenced to 2.5 V.

**DISTRIBUTION OF TLV2442  
INPUT OFFSET VOLTAGE**

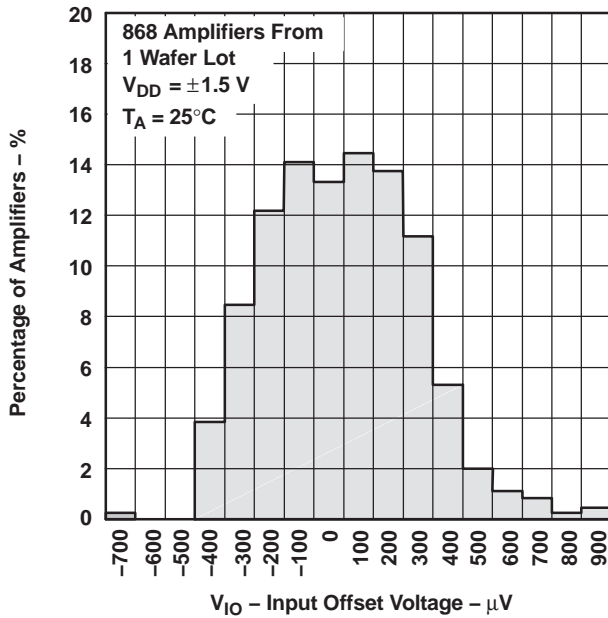

Figure 2.

**DISTRIBUTION OF TLV2442  
INPUT OFFSET VOLTAGE**

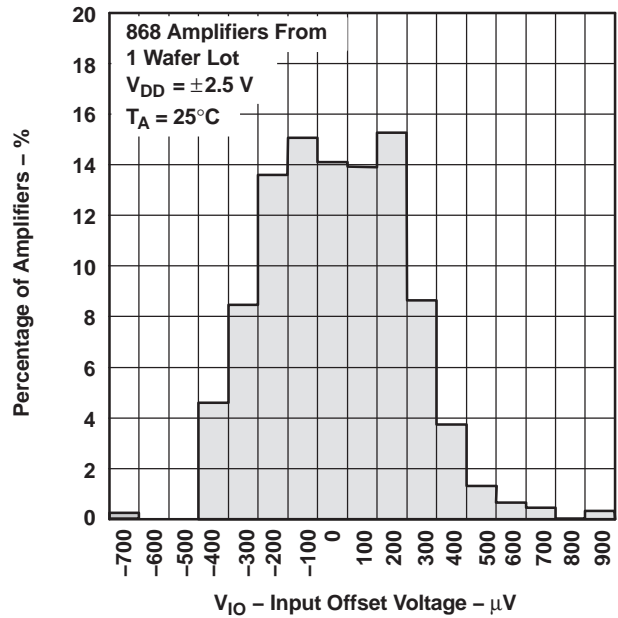

Figure 3.

**INPUT OFFSET VOLTAGE  
vs  
COMMON-MODE INPUT VOLTAGE**

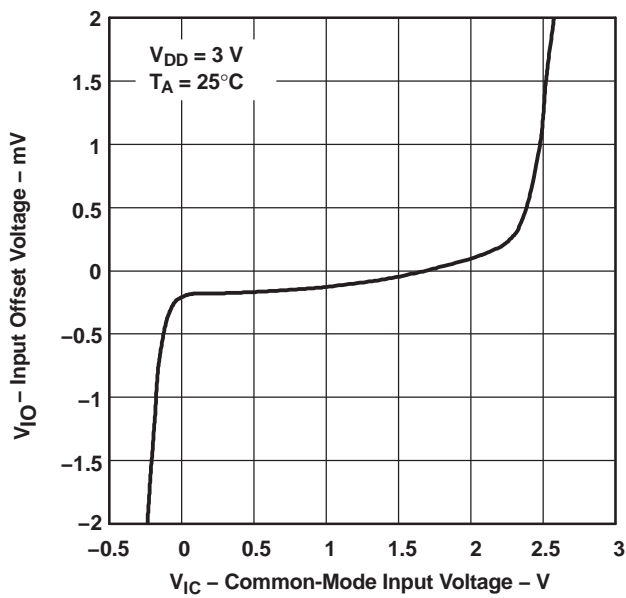

Figure 4.

**INPUT OFFSET VOLTAGE  
vs  
COMMON-MODE INPUT VOLTAGE**

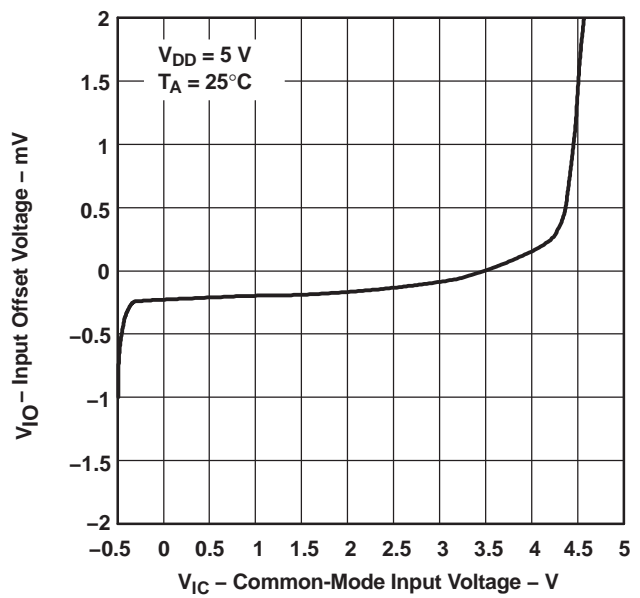

Figure 5.

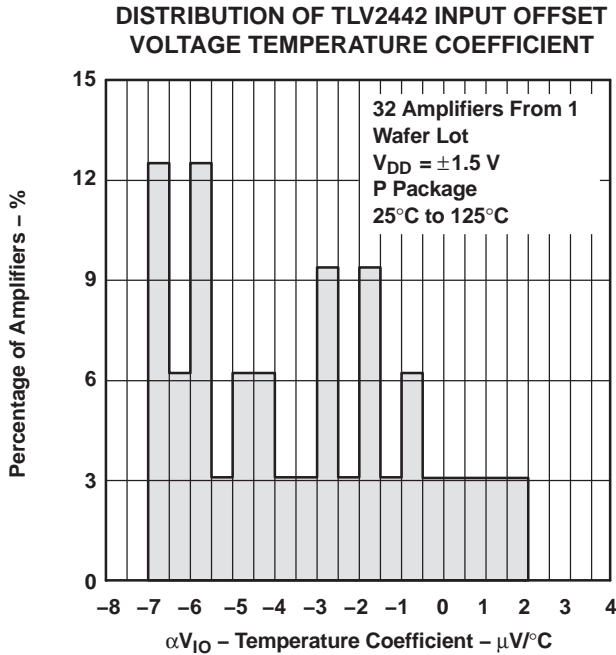

Figure 6.

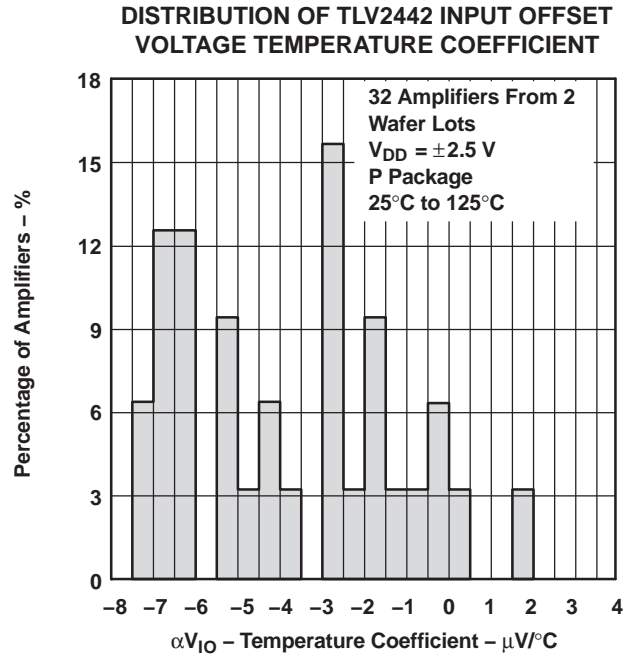

Figure 7.

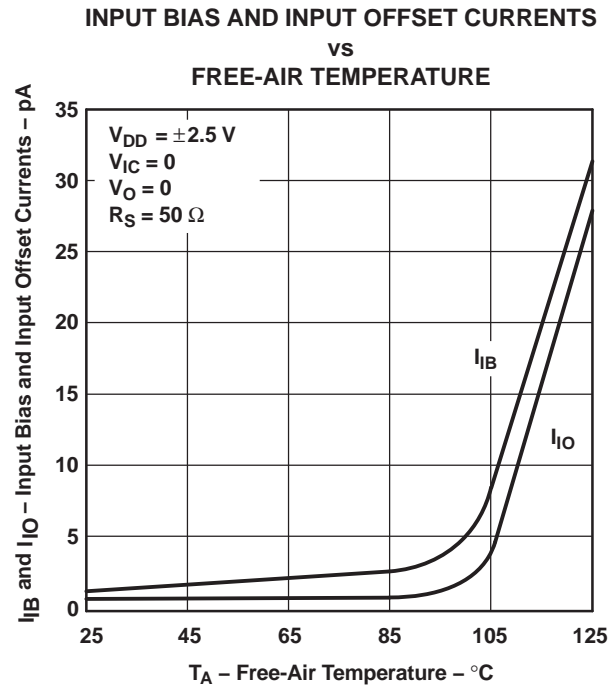

Figure 8.

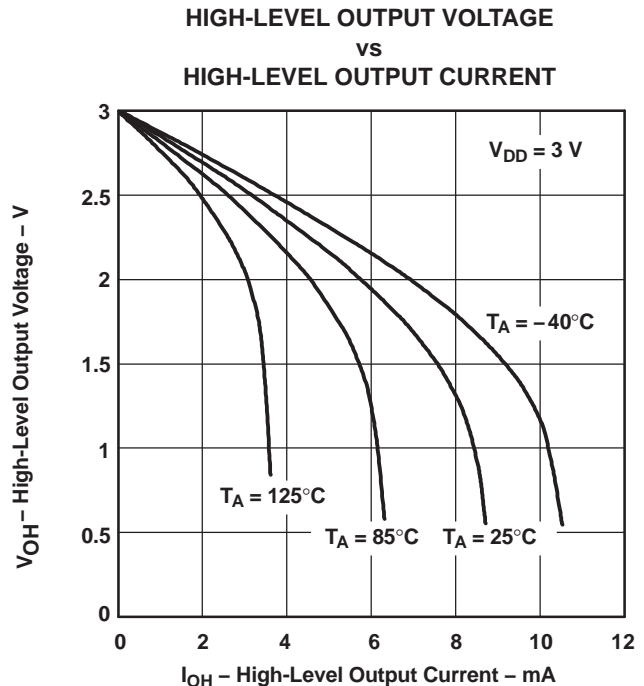

Figure 9.

HIGH-LEVEL OUTPUT VOLTAGE  
VS  
HIGH-LEVEL OUTPUT CURRENT

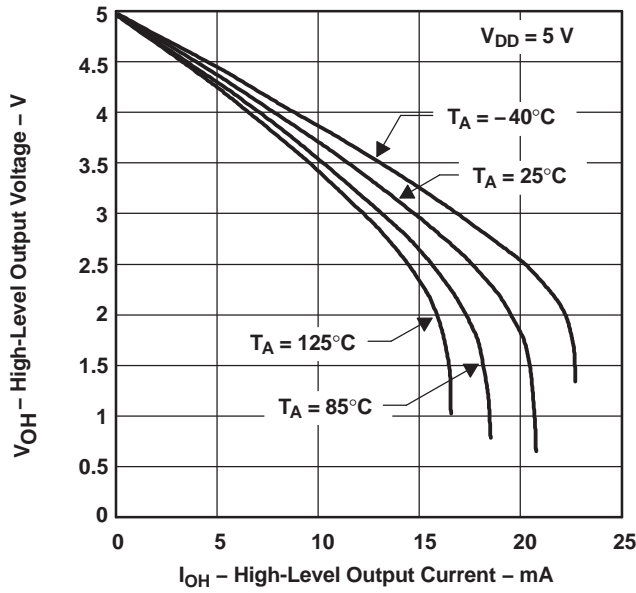

Figure 10.

LOW-LEVEL OUTPUT VOLTAGE  
VS  
LOW-LEVEL OUTPUT CURRENT

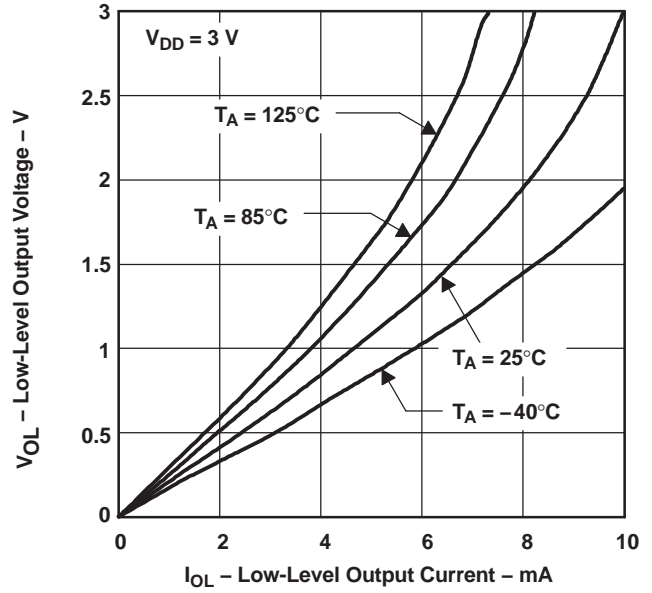

Figure 11.

LOW-LEVEL OUTPUT VOLTAGE  
VS  
LOW-LEVEL OUTPUT CURRENT

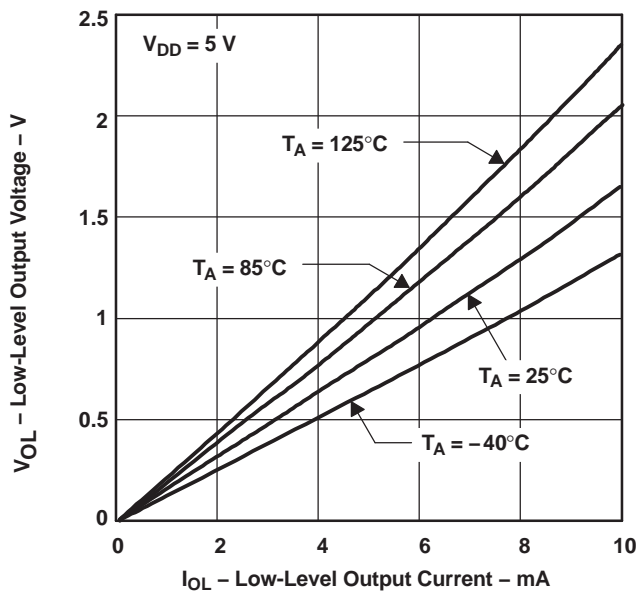

Figure 12.

MAXIMUM PEAK-TO-PEAK OUTPUT VOLTAGE  
VS  
FREQUENCY

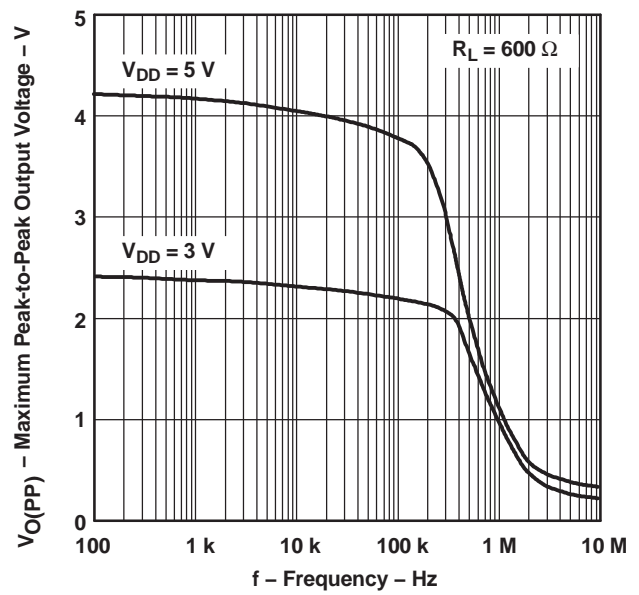

Figure 13.

SHORT-CIRCUIT OUTPUT CURRENT  
VS  
SUPPLY VOLTAGE

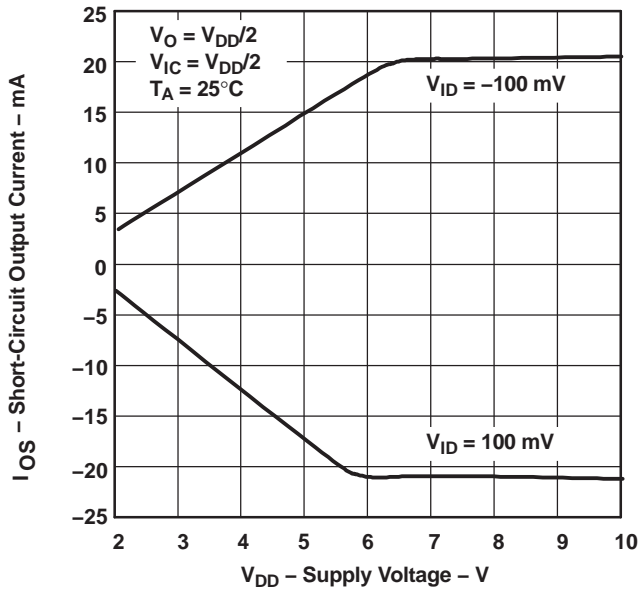

Figure 14.

SHORT-CIRCUIT OUTPUT CURRENT  
VS  
FREE-AIR TEMPERATURE

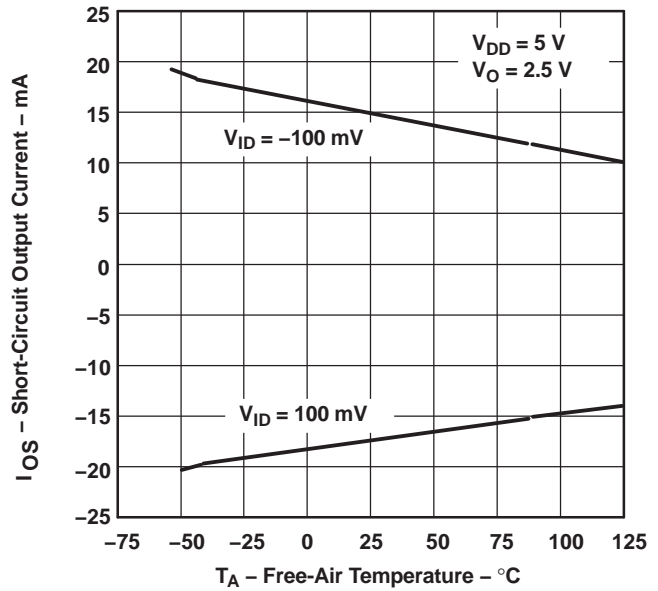

Figure 15.

OUTPUT VOLTAGE  
VS  
DIFFERENTIAL INPUT VOLTAGE

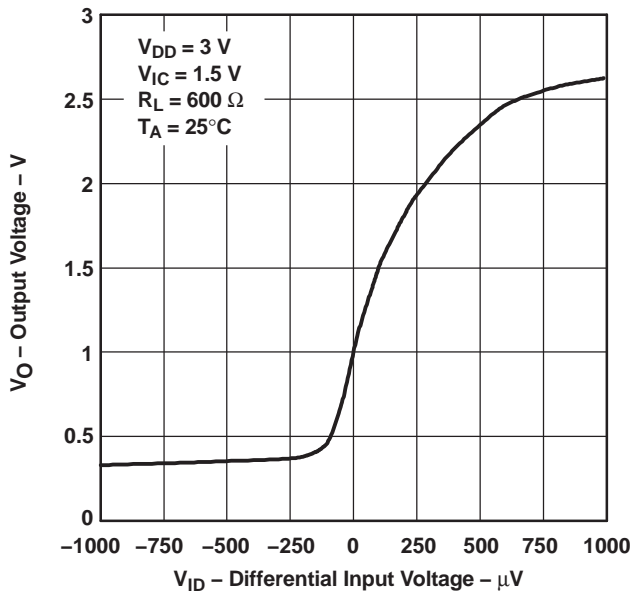

Figure 16.

OUTPUT VOLTAGE  
VS  
DIFFERENTIAL INPUT VOLTAGE

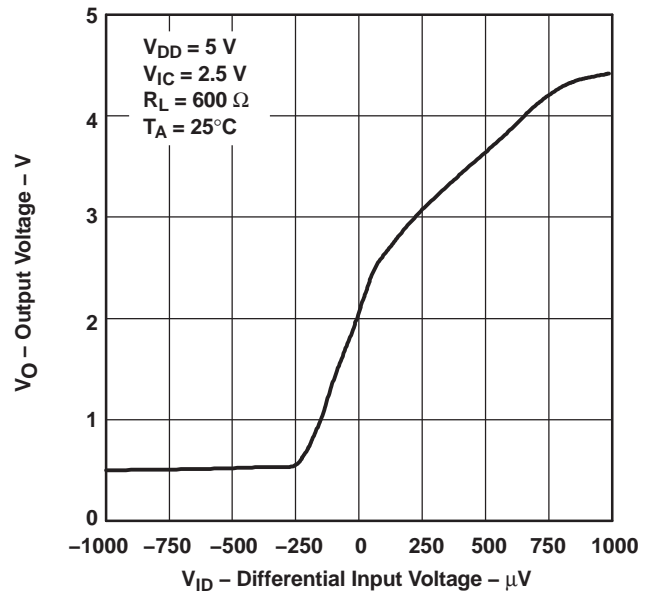
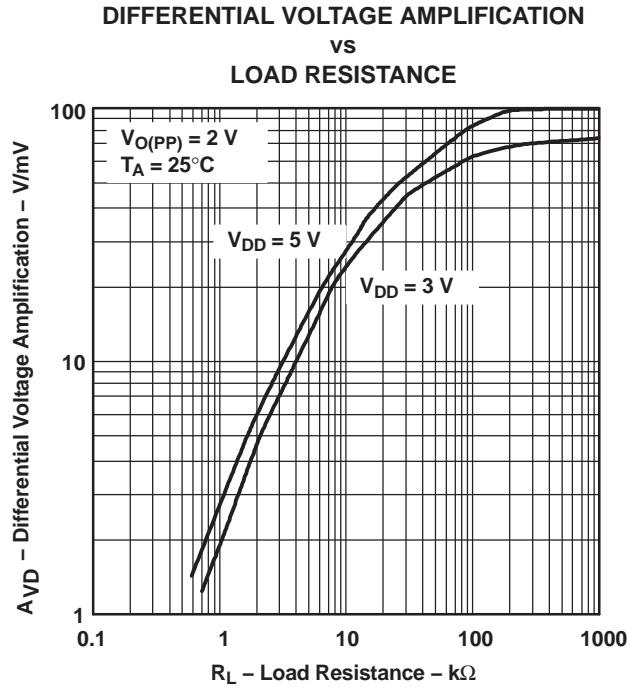
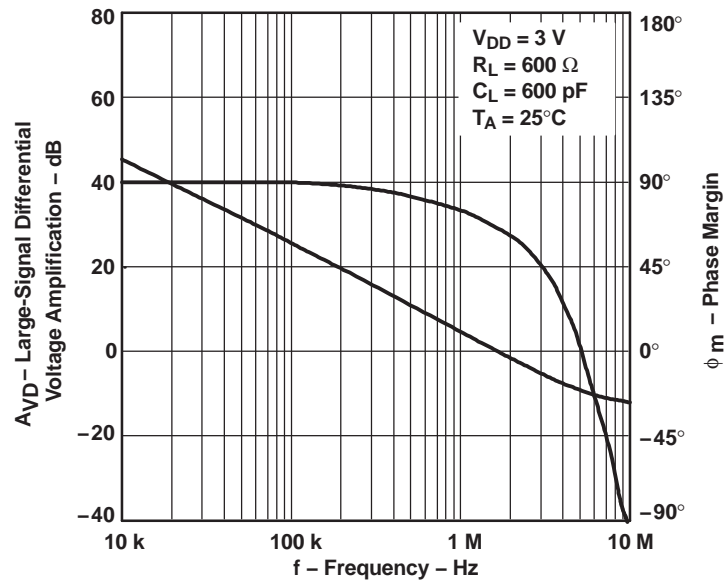

Figure 17.



**Figure 18.  
 LARGE-SIGNAL DIFFERENTIAL VOLTAGE  
 AMPLIFICATION AND PHASE MARGIN  
 vs  
 FREQUENCY**



**Figure 19.**

LARGE-SIGNAL DIFFERENTIAL VOLTAGE AMPLIFICATION AND PHASE MARGIN  
vs  
FREQUENCY

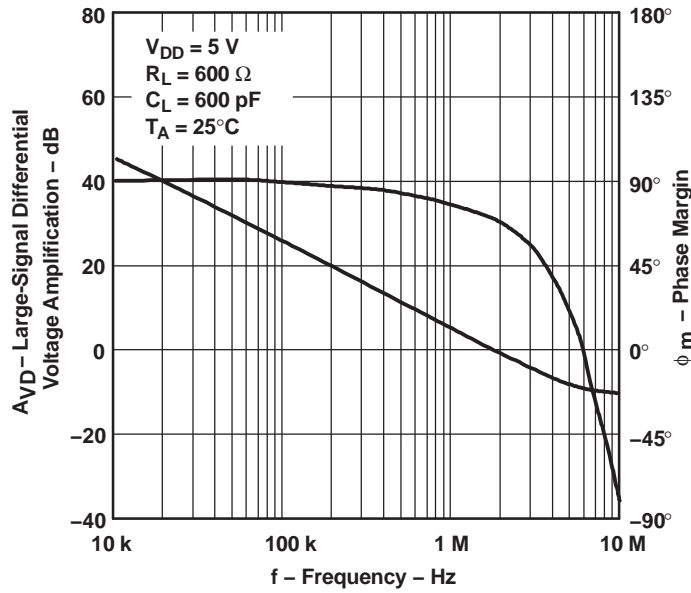

Figure 20.

LARGE-SIGNAL DIFFERENTIAL VOLTAGE AMPLIFICATION  
vs  
FREE-AIR TEMPERATURE

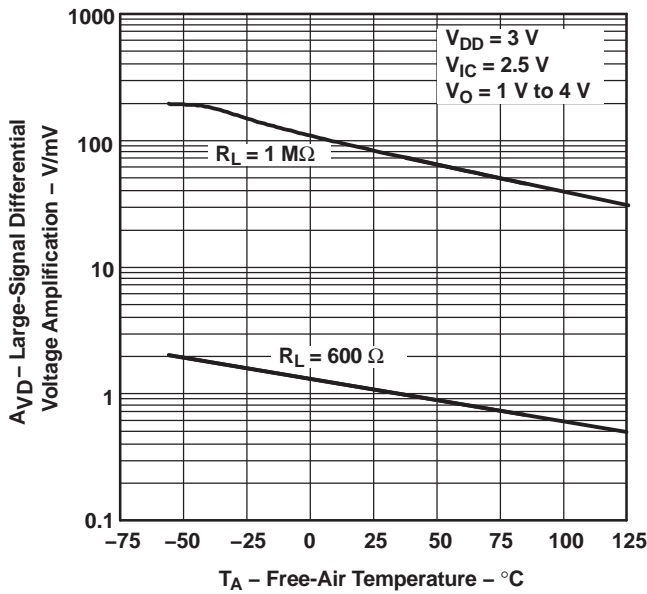

Figure 21.

LARGE-SIGNAL DIFFERENTIAL VOLTAGE AMPLIFICATION  
vs  
FREE-AIR TEMPERATURE

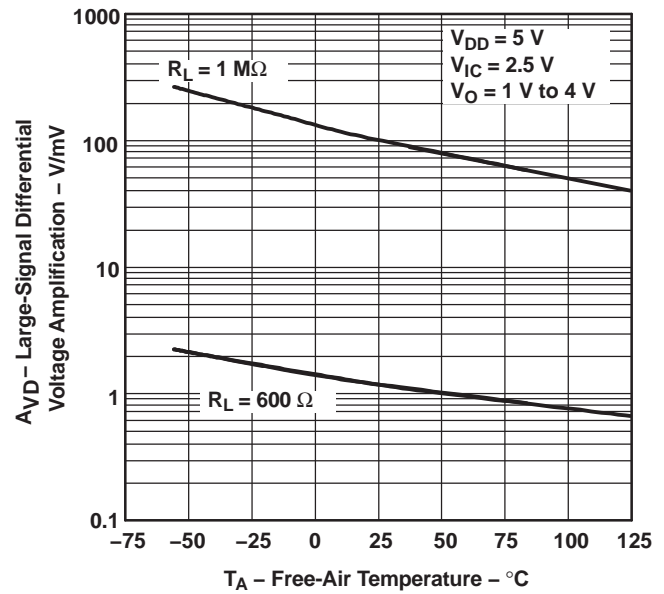

Figure 22.

OUTPUT IMPEDANCE  
VS  
FREQUENCY

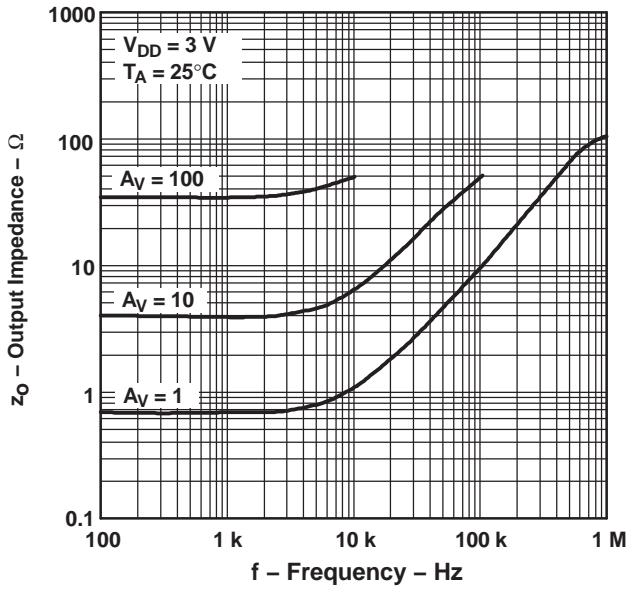

Figure 23.

OUTPUT IMPEDANCE  
VS  
FREQUENCY

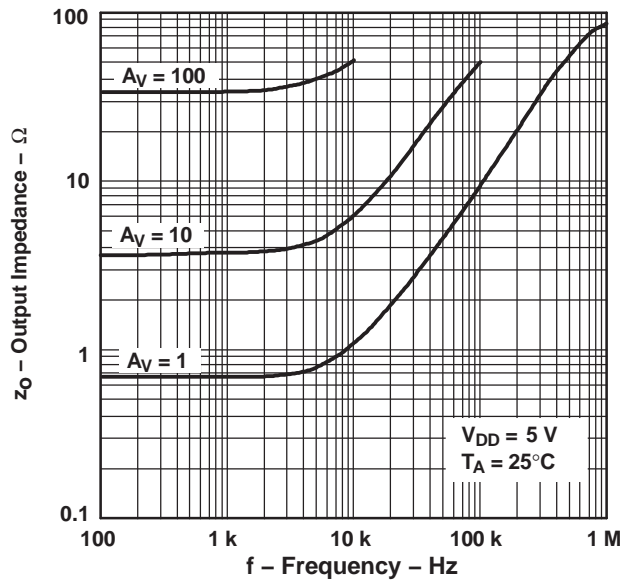

Figure 24.

COMMON-MODE REJECTION RATIO  
VS  
FREQUENCY

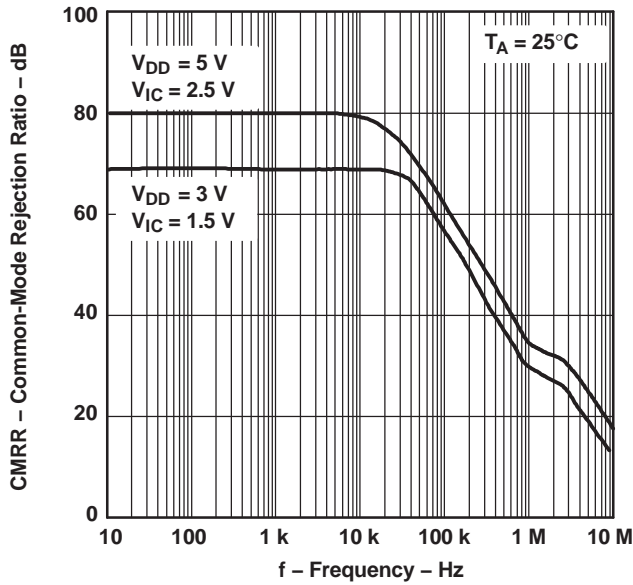

Figure 25.

COMMON-MODE REJECTION RATIO  
VS  
FREE-AIR TEMPERATURE

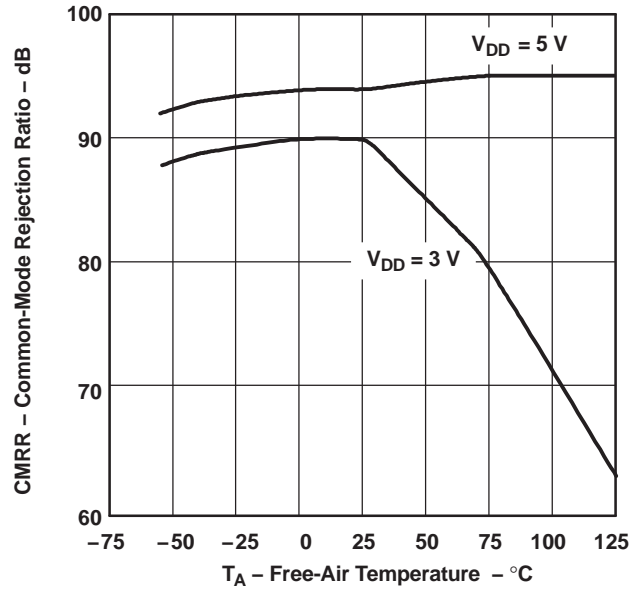

Figure 26.

SUPPLY-VOLTAGE REJECTION RATIO  
VS  
FREQUENCY

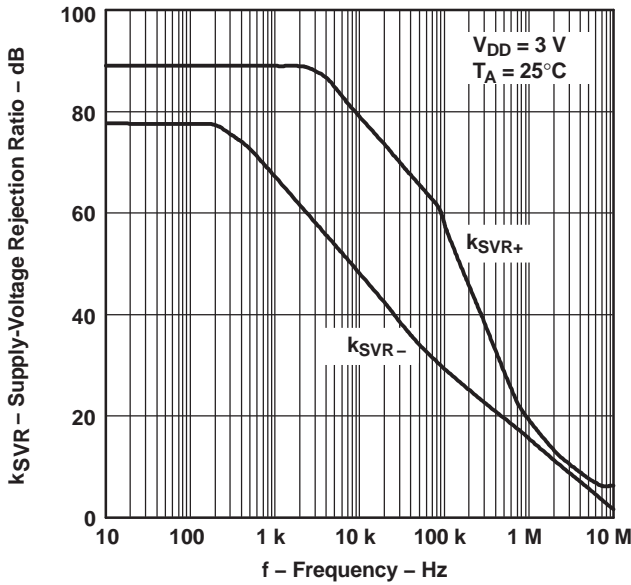

Figure 27.

SUPPLY-VOLTAGE REJECTION RATIO  
VS  
FREQUENCY

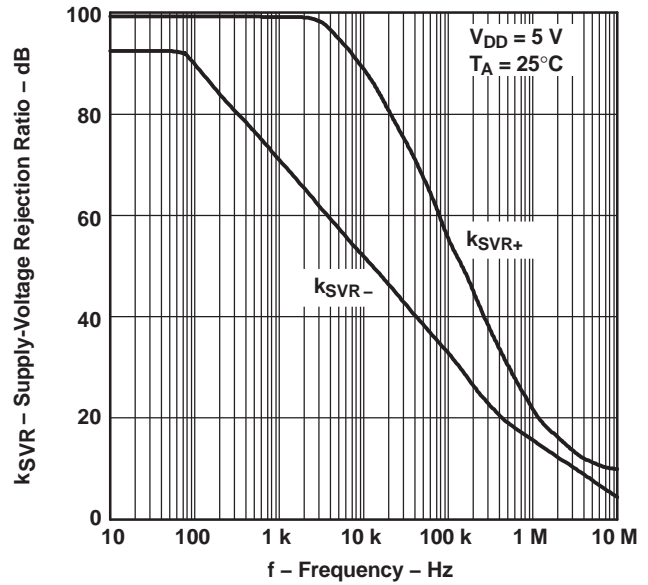

Figure 28.

SUPPLY-VOLTAGE REJECTION RATIO  
VS  
FREE-AIR TEMPERATURE

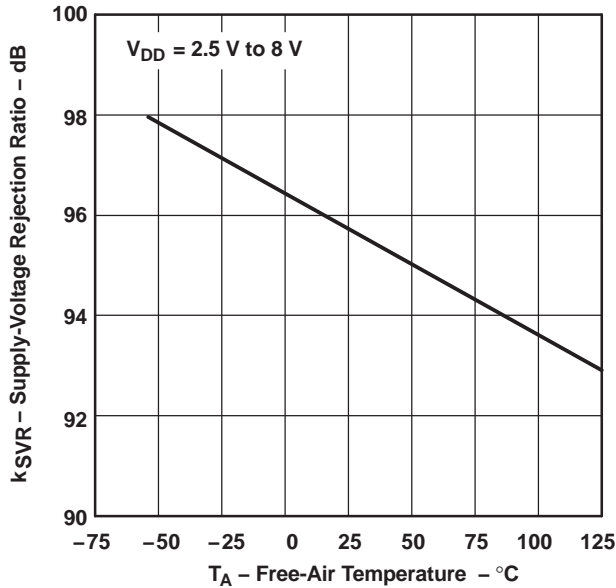

Figure 29.

SUPPLY CURRENT  
VS  
SUPPLY VOLTAGE

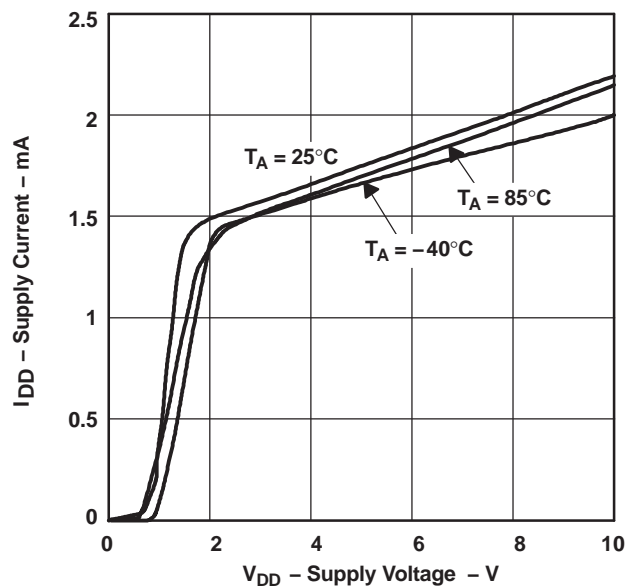
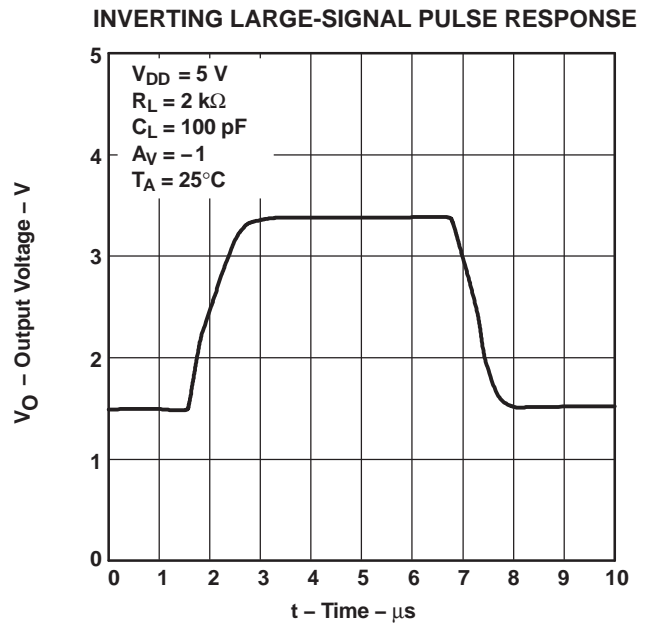
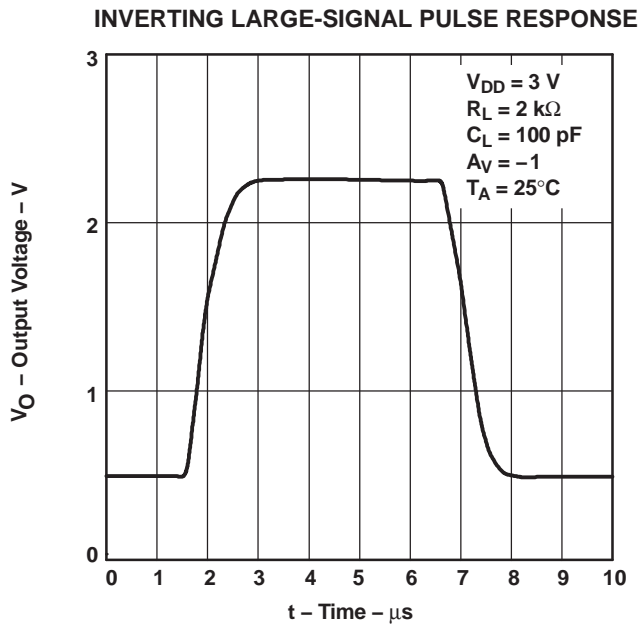
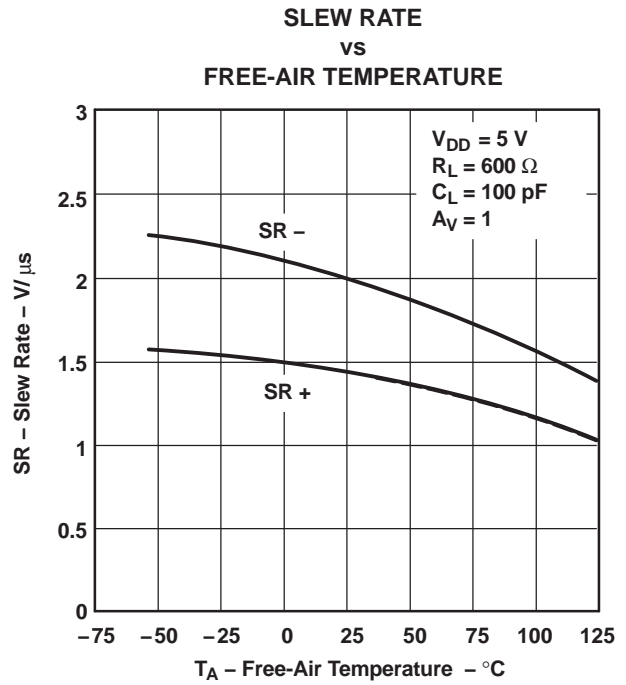
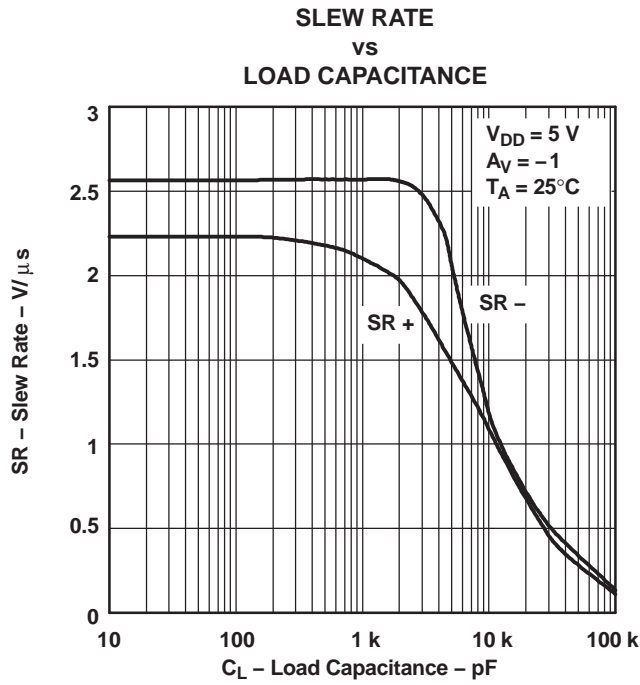

Figure 30.



VOLTAGE-FOLLOWER  
LARGE-SIGNAL PULSE RESPONSE

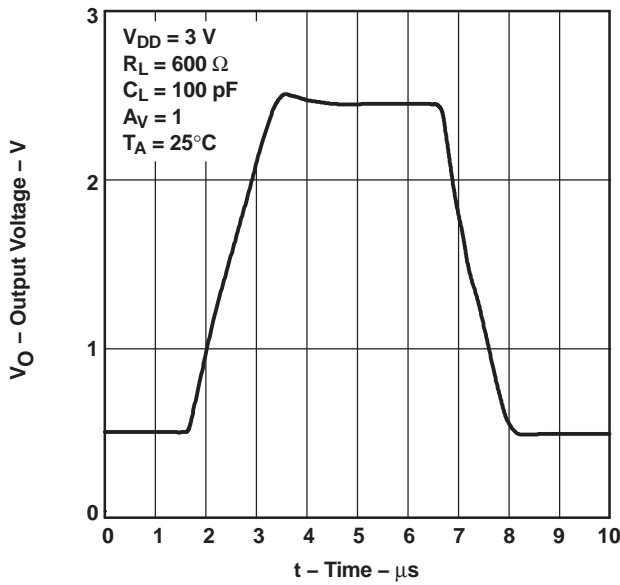

Figure 35.

VOLTAGE-FOLLOWER  
LARGE-SIGNAL PULSE RESPONSE

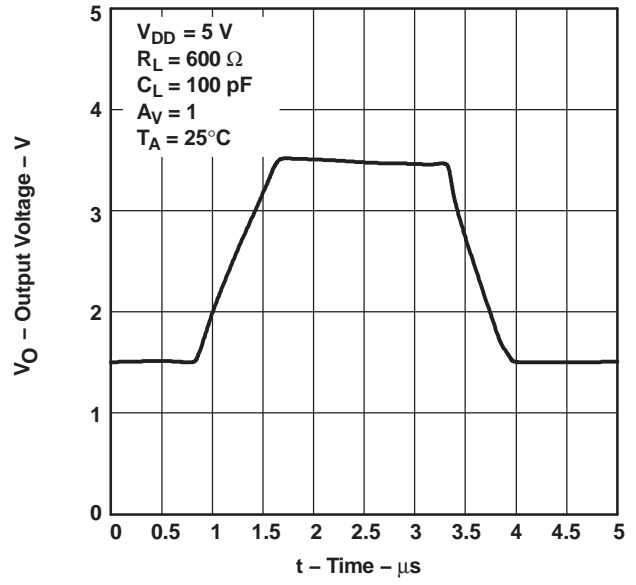

Figure 36.

INVERTING SMALL-SIGNAL PULSE RESPONSE

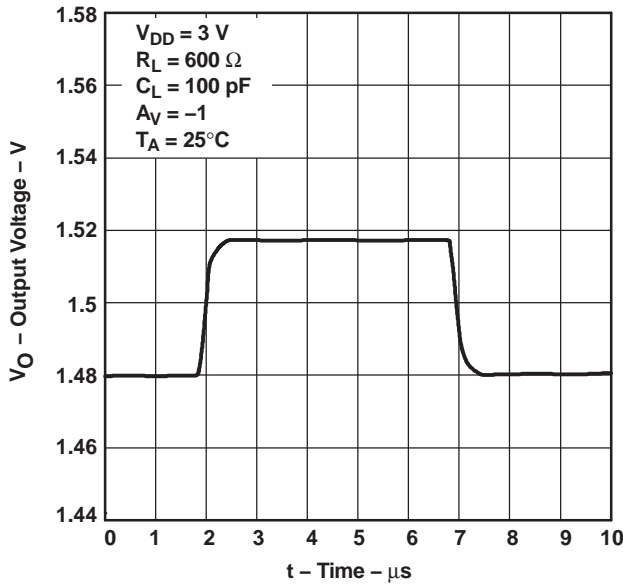

Figure 37.

INVERTING SMALL-SIGNAL PULSE RESPONSE

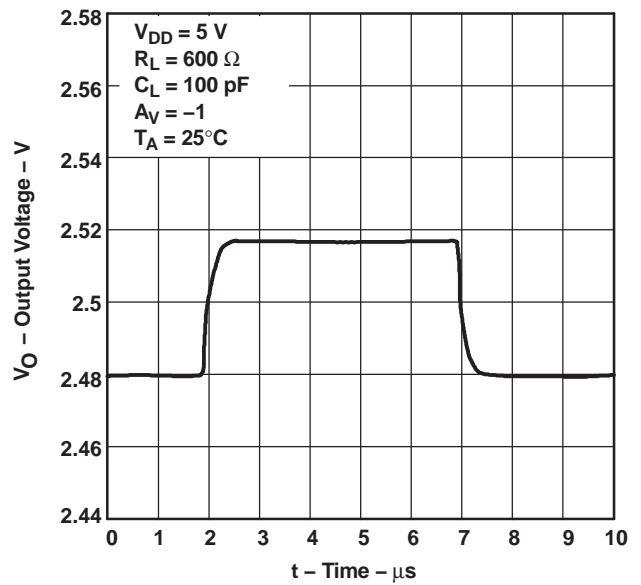

Figure 38.

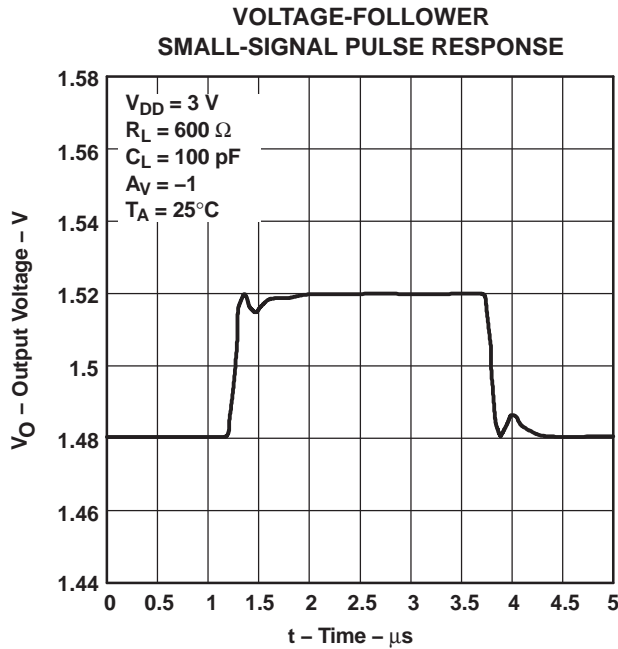

Figure 39.

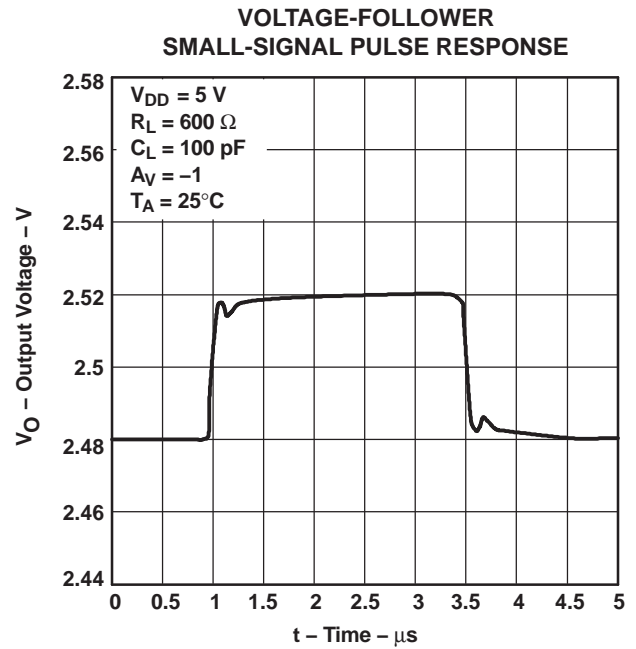

Figure 40.

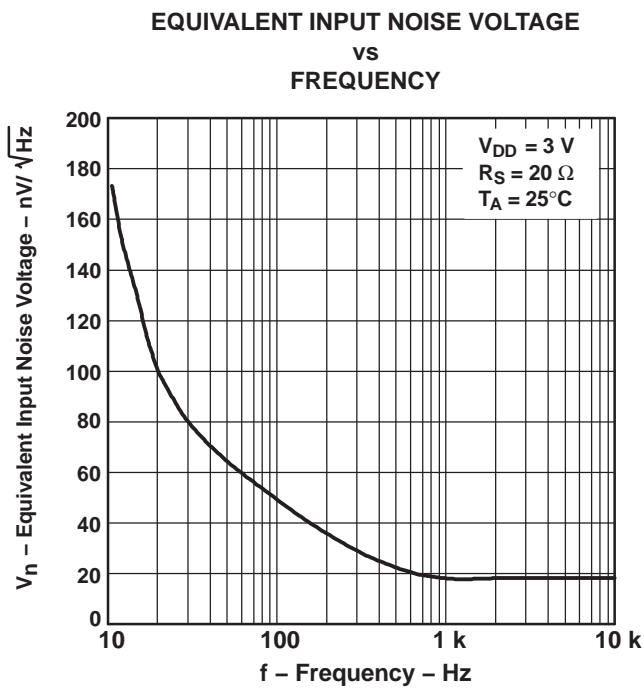

Figure 41.

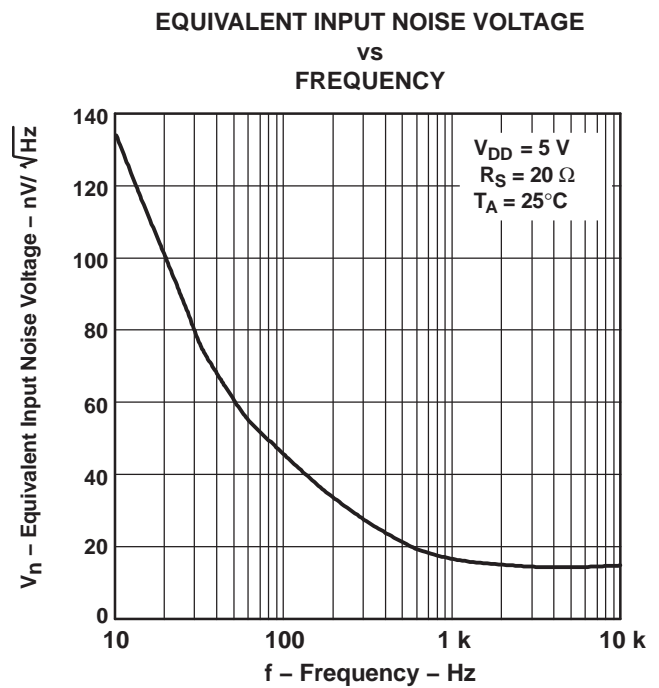

Figure 42.

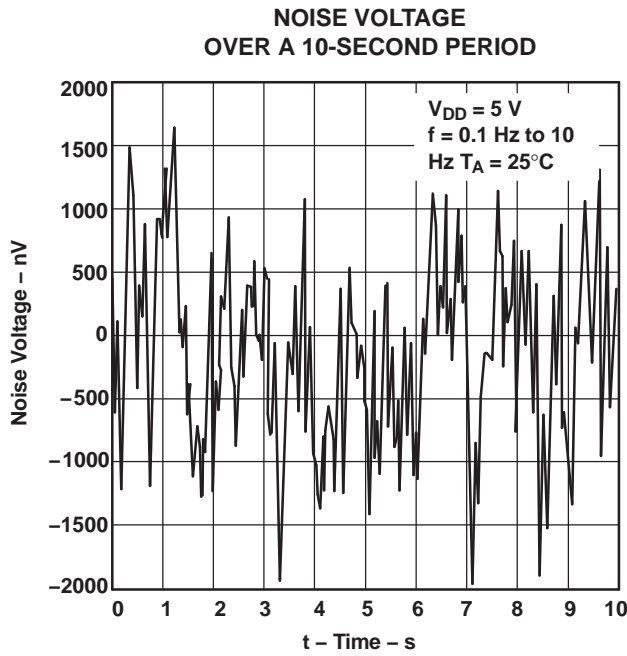

Figure 43.

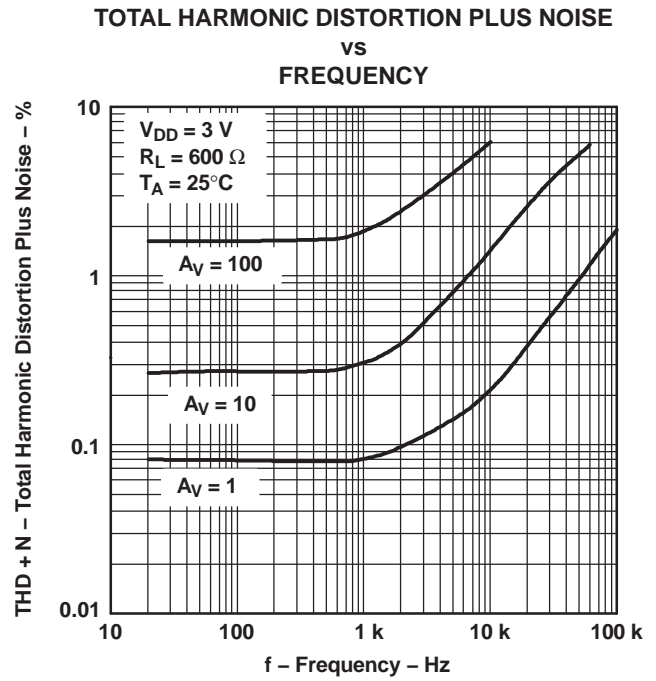

Figure 44.

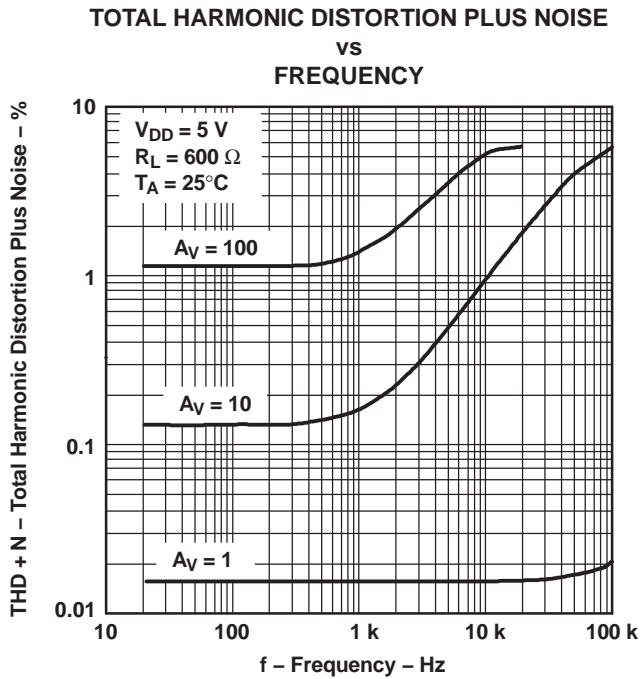

Figure 45.

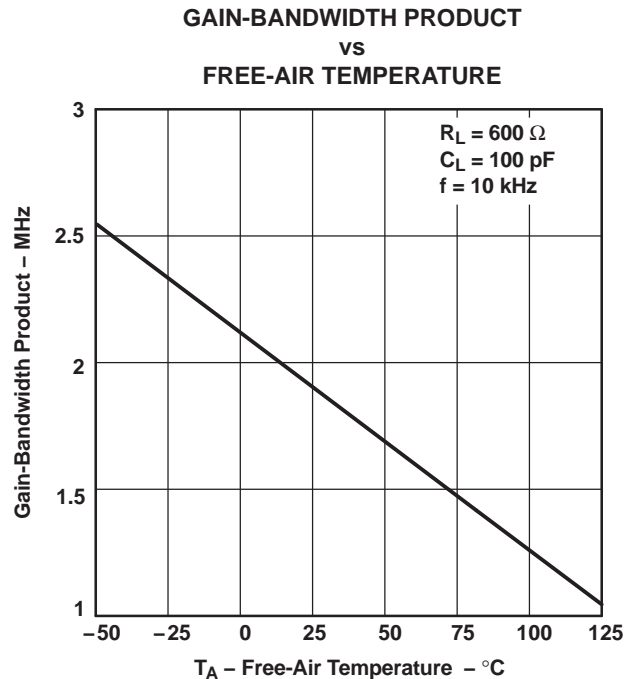

Figure 46.

GAIN-BANDWIDTH PRODUCT  
VS  
SUPPLY VOLTAGE

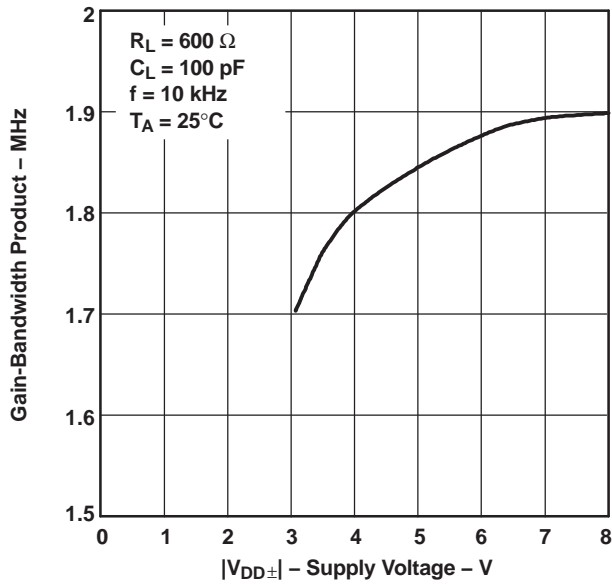

Figure 47.

PHASE MARGIN  
VS  
LOAD CAPACITANCE

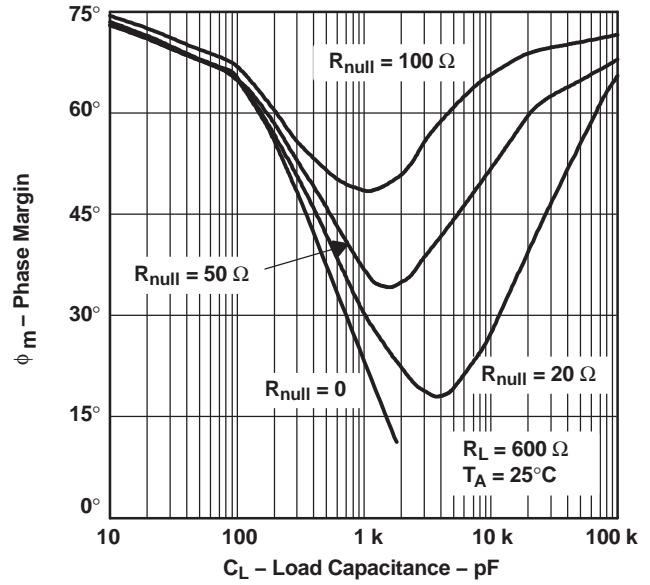

Figure 48.

GAIN MARGIN  
VS  
LOAD CAPACITANCE

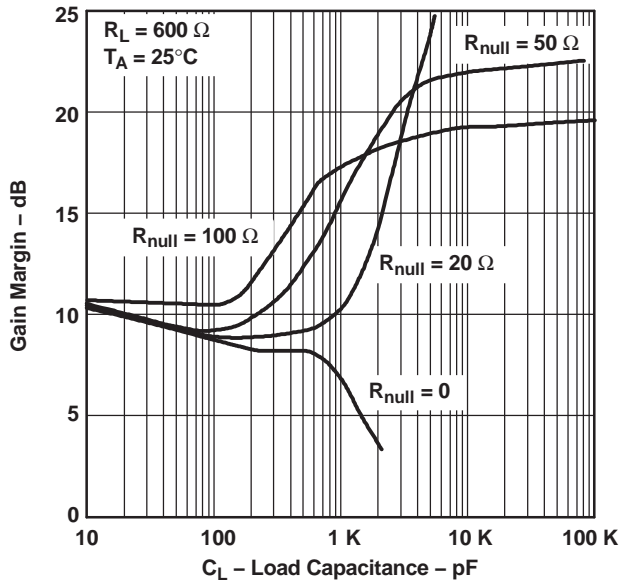

Figure 49.

UNITY-GAIN BANDWIDTH  
VS  
LOAD CAPACITANCE

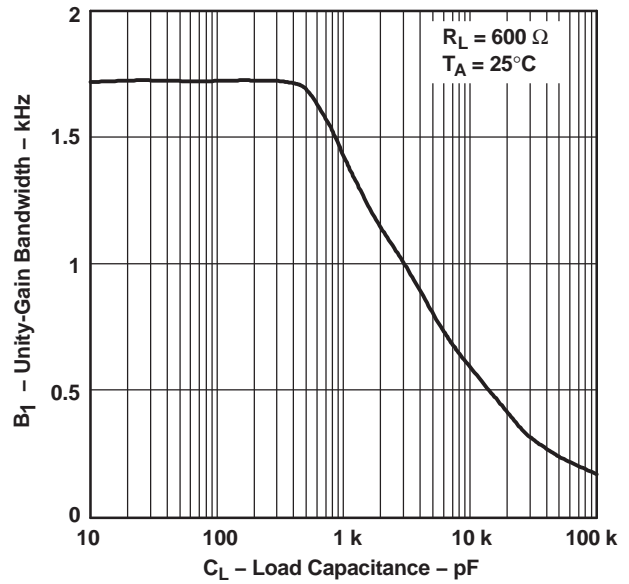

Figure 50.

APPLICATION INFORMATION

macromodel information

Macromodel information provided was derived using PSpice™ Parts™ model generation software. The Boyle macromodel<sup>(2)</sup> and subcircuit in Figure 51 were generated using the TLV244x typical electrical and operating characteristics at T<sub>A</sub> = 25°C. Using this information, output simulations of the following key parameters can be generated to a tolerance of 20% (in most cases):

(2) G. R. Boyle, B. M. Cohn, D. O. Pederson, and J. E. Solomon, "Macromodeling of Integrated Circuit Operational Amplifiers," *IEEE Journal of Solid-State Circuits*, SC-9, 353 (1974).

- Maximum positive output voltage swing
- Maximum negative output voltage swing
- Slew rate
- Quiescent power dissipation
- Input bias current
- Open-loop voltage amplification
- Unity gain frequency
- Common-mode rejection ratio
- Phase margin
- DC output resistance
- AC output resistance
- Short-circuit output current limit

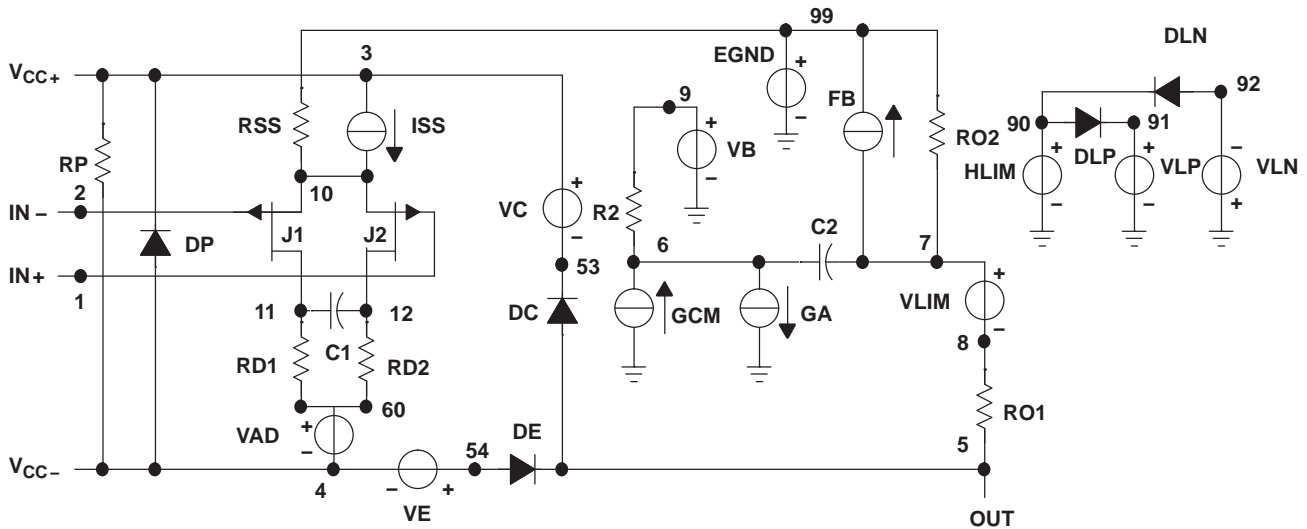

```
.SUBCKT TLV2442 1 2 3 4 5
C1      11      12      14E-12
C2      6       7       60.00E-12
DC      5       53      DX
DE      54      5       DX
DLP     90      91      DX
DLN     92      90      DX
DP      4       3       DX
EGND    99      0       POLY (2) (3,0) (4,) 0 .5 .5
FB      7       99      POLY (5) VB VC VE VLP VLN 0
+ 984.9E3 -1E6 1E6 1E6 -1E6
GA      6       0       11      12 377.0E-6
GCM     0       6       10      99 134E-9
ISS     3       10      DC 216.0E-6
HLIM    90      0       VLIM 1K
J1      11      2       10 JX
J2      12      1       10 JX
R2      6       9       100.OE3
RD1     60      11      2.653E3
RD2     60      12      2.653E3
R01     8       5       50
R02     7       99      50
RP      3       4       4.310E3
RSS     10      99      925.9E3
VAD     60      4       -.5
VB      9       0       DC 0
VC      3       53      DC .78
VE      54      4       DC .78
VLIM    7       8       DC 0
VLP     91      0       DC 1.9
VLN     0       92      DC 9.4
.MODEL DX D (IS=800.0E-18)
.MODEL JX PJF (IS=1.500E-12BETA=1.316E-3
+ VTO=-.270)
.ENDS
```

Figure 51. Boyle Macromodel and Subcircuit

**PACKAGING INFORMATION**

Orderable Device	Status (1)	Package Type	Package Drawing	Pins	Package Qty	Eco Plan (2)	Lead/Ball Finish (6)	MSL Peak Temp (3)	Op Temp (°C)	Device Marking (4/5)	Samples
TLV2442AQDRG4Q1	ACTIVE	SOIC	D	8	2500	Green (RoHS & no Sb/Br)	CU NIPDAU	Level-1-260C-UNLIM	-40 to 125	2442AQ	<a href="#">Samples</a>
TLV2442AQDRQ1	ACTIVE	SOIC	D	8	2500	Green (RoHS & no Sb/Br)	CU NIPDAU	Level-1-260C-UNLIM	-40 to 125	2442AQ	<a href="#">Samples</a>
TLV2442AQPWRG4Q1	ACTIVE	TSSOP	PW	8	2000	Green (RoHS & no Sb/Br)	CU NIPDAU	Level-1-260C-UNLIM	-40 to 125	2442AQ	<a href="#">Samples</a>
TLV2442AQPWRQ1	OBSOLETE	TSSOP	PW	8		TBD	Call TI	Call TI	-40 to 125		
TLV2442QDGKRQ1	ACTIVE	VSSOP	DGK	8	2500	Green (RoHS & no Sb/Br)	CU NIPDAU   CU NIPDAUAG	Level-2-260C-1 YEAR	-40 to 125	OBR	<a href="#">Samples</a>
TLV2442QDRQ1	OBSOLETE	SOIC	D	8		TBD	Call TI	Call TI	-40 to 125		
TLV2442QPWRG4Q1	ACTIVE	TSSOP	PW	8	2000	Green (RoHS & no Sb/Br)	CU NIPDAU	Level-1-260C-UNLIM	-40 to 125	2442Q1	<a href="#">Samples</a>
TLV2442QPWRQ1	OBSOLETE	TSSOP	PW	8		TBD	Call TI	Call TI	-40 to 125		
TLV2444AQPWRQ1	ACTIVE	TSSOP	PW	14	2000	Green (RoHS & no Sb/Br)	CU NIPDAU	Level-1-260C-UNLIM	-40 to 125	2444AQ	<a href="#">Samples</a>

(1) The marketing status values are defined as follows:

**ACTIVE:** Product device recommended for new designs.

**LIFEBUY:** TI has announced that the device will be discontinued, and a lifetime-buy period is in effect.

**NRND:** Not recommended for new designs. Device is in production to support existing customers, but TI does not recommend using this part in a new design.

**PREVIEW:** Device has been announced but is not in production. Samples may or may not be available.

**OBSOLETE:** TI has discontinued the production of the device.

(2) Eco Plan - The planned eco-friendly classification: Pb-Free (RoHS), Pb-Free (RoHS Exempt), or Green (RoHS & no Sb/Br) - please check <http://www.ti.com/productcontent> for the latest availability information and additional product content details.

**TBD:** The Pb-Free/Green conversion plan has not been defined.

**Pb-Free (RoHS):** TI's terms "Lead-Free" or "Pb-Free" mean semiconductor products that are compatible with the current RoHS requirements for all 6 substances, including the requirement that lead not exceed 0.1% by weight in homogeneous materials. Where designed to be soldered at high temperatures, TI Pb-Free products are suitable for use in specified lead-free processes.

**Pb-Free (RoHS Exempt):** This component has a RoHS exemption for either 1) lead-based flip-chip solder bumps used between the die and package, or 2) lead-based die adhesive used between the die and leadframe. The component is otherwise considered Pb-Free (RoHS compatible) as defined above.

**Green (RoHS & no Sb/Br):** TI defines "Green" to mean Pb-Free (RoHS compatible), and free of Bromine (Br) and Antimony (Sb) based flame retardants (Br or Sb do not exceed 0.1% by weight in homogeneous material)

(3) MSL, Peak Temp. - The Moisture Sensitivity Level rating according to the JEDEC industry standard classifications, and peak solder temperature.

(4) There may be additional marking, which relates to the logo, the lot trace code information, or the environmental category on the device.

<sup>(5)</sup> Multiple Device Markings will be inside parentheses. Only one Device Marking contained in parentheses and separated by a "~" will appear on a device. If a line is indented then it is a continuation of the previous line and the two combined represent the entire Device Marking for that device.

<sup>(6)</sup> Lead/Ball Finish - Orderable Devices may have multiple material finish options. Finish options are separated by a vertical ruled line. Lead/Ball Finish values may wrap to two lines if the finish value exceeds the maximum column width.

**Important Information and Disclaimer:**The information provided on this page represents TI's knowledge and belief as of the date that it is provided. TI bases its knowledge and belief on information provided by third parties, and makes no representation or warranty as to the accuracy of such information. Efforts are underway to better integrate information from third parties. TI has taken and continues to take reasonable steps to provide representative and accurate information but may not have conducted destructive testing or chemical analysis on incoming materials and chemicals. TI and TI suppliers consider certain information to be proprietary, and thus CAS numbers and other limited information may not be available for release.

In no event shall TI's liability arising out of such information exceed the total purchase price of the TI part(s) at issue in this document sold by TI to Customer on an annual basis.

**OTHER QUALIFIED VERSIONS OF TLV2442-Q1, TLV2442A-Q1, TLV2444A-Q1 :**

- Catalog: [TLV2442](#), [TLV2442A](#), [TLV2444A](#)
- Military: [TLV2442M](#), [TLV2442AM](#)

**NOTE: Qualified Version Definitions:**

- Catalog - TI's standard catalog product
- Military - QML certified for Military and Defense Applications

## TAPE AND REEL INFORMATION



### QUADRANT ASSIGNMENTS FOR PIN 1 ORIENTATION IN TAPE



\*All dimensions are nominal

Device	Package Type	Package Drawing	Pins	SPQ	Reel Diameter (mm)	Reel Width W1 (mm)	A0 (mm)	B0 (mm)	K0 (mm)	P1 (mm)	W (mm)	Pin1 Quadrant
TLV2442QDGKRQ1	VSSOP	DGK	8	2500	330.0	12.4	5.3	3.4	1.4	8.0	12.0	Q1
TLV2442QPWRG4Q1	TSSOP	PW	8	2000	330.0	12.4	7.0	3.6	1.6	8.0	12.0	Q1
TLV2444AQWRQ1	TSSOP	PW	14	2000	330.0	12.4	6.9	5.6	1.6	8.0	12.0	Q1

**TAPE AND REEL BOX DIMENSIONS**

\*All dimensions are nominal

Device	Package Type	Package Drawing	Pins	SPQ	Length (mm)	Width (mm)	Height (mm)
TLV2442QDGKRQ1	VSSOP	DGK	8	2500	367.0	367.0	35.0
TLV2442QPWRG4Q1	TSSOP	PW	8	2000	367.0	367.0	35.0
TLV2444AQPWRQ1	TSSOP	PW	14	2000	367.0	367.0	35.0





- NOTES:
- A. All linear dimensions are in millimeters.
  - B. This drawing is subject to change without notice.
  - C. Publication IPC-7351 is recommended for alternate designs.
  - D. Laser cutting apertures with trapezoidal walls and also rounding corners will offer better paste release. Customers should contact their board assembly site for stencil design recommendations. Refer to IPC-7525 for other stencil recommendations.
  - E. Customers should contact their board fabrication site for solder mask tolerances between and around signal pads.



PW (R-PDSO-G14)

PLASTIC SMALL OUTLINE



4211284-2/G 08/15

- NOTES:
- All linear dimensions are in millimeters.
  - This drawing is subject to change without notice.
  - Publication IPC-7351 is recommended for alternate designs.
  - Laser cutting apertures with trapezoidal walls and also rounding corners will offer better paste release. Customers should contact their board assembly site for stencil design recommendations. Refer to IPC-7525 for other stencil recommendations.
  - Customers should contact their board fabrication site for solder mask tolerances between and around signal pads.

PW0008A



**PACKAGE OUTLINE**  
**TSSOP - 1.2 mm max height**

SMALL OUTLINE PACKAGE

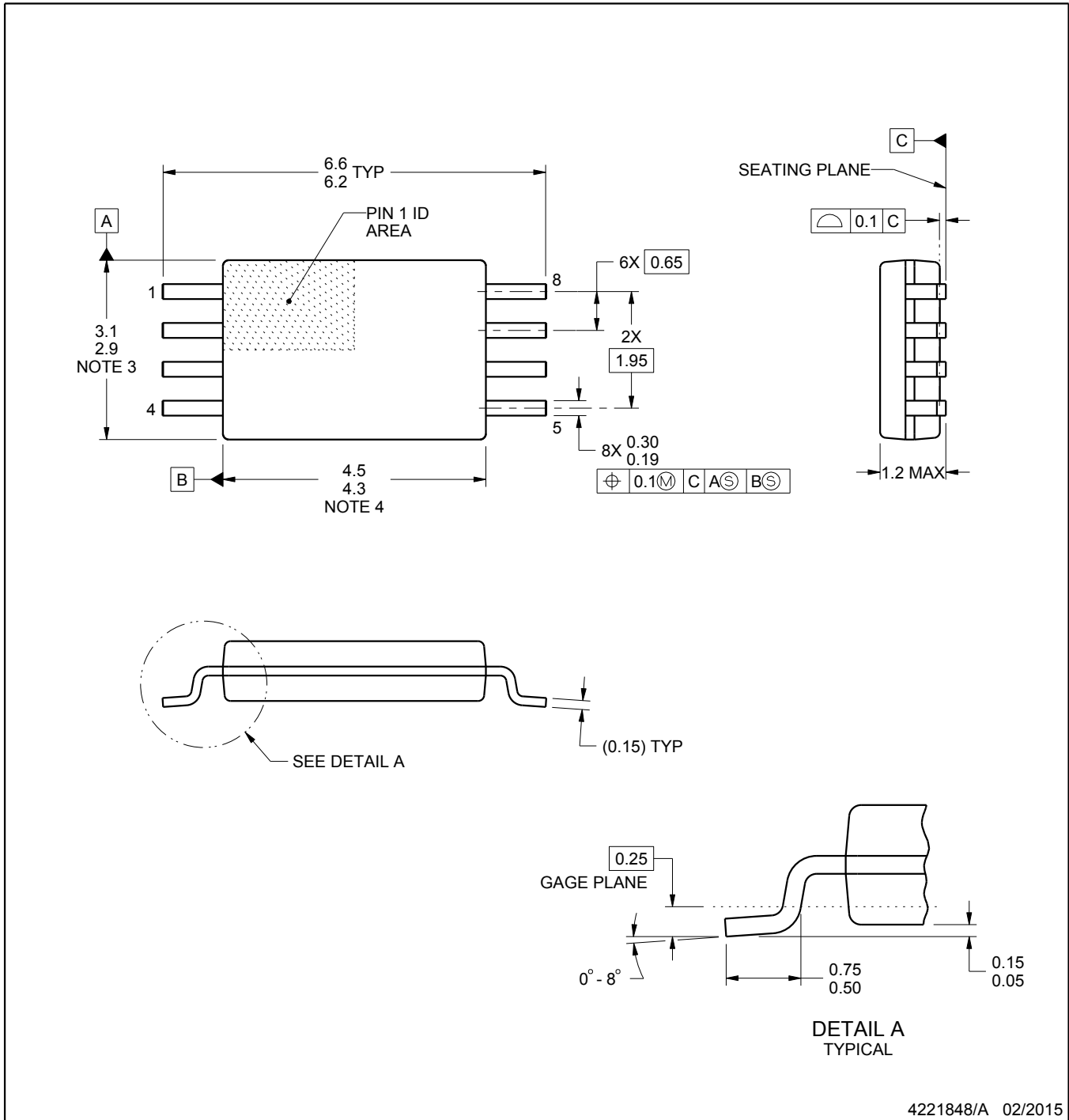

4221848/A 02/2015

NOTES:

1. All linear dimensions are in millimeters. Any dimensions in parenthesis are for reference only. Dimensioning and tolerancing per ASME Y14.5M.
2. This drawing is subject to change without notice.
3. This dimension does not include mold flash, protrusions, or gate burrs. Mold flash, protrusions, or gate burrs shall not exceed 0.15 mm per side.
4. This dimension does not include interlead flash. Interlead flash shall not exceed 0.25 mm per side.
5. Reference JEDEC registration MO-153, variation AA.

# EXAMPLE BOARD LAYOUT

PW0008A

TSSOP - 1.2 mm max height

SMALL OUTLINE PACKAGE



LAND PATTERN EXAMPLE  
SCALE:10X



SOLDER MASK DETAILS  
NOT TO SCALE

4221848/A 02/2015

NOTES: (continued)

- 6. Publication IPC-7351 may have alternate designs.
- 7. Solder mask tolerances between and around signal pads can vary based on board fabrication site.

# EXAMPLE STENCIL DESIGN

PW0008A

TSSOP - 1.2 mm max height

SMALL OUTLINE PACKAGE



SOLDER PASTE EXAMPLE  
BASED ON 0.125 mm THICK STENCIL  
SCALE:10X

4221848/A 02/2015

NOTES: (continued)

8. Laser cutting apertures with trapezoidal walls and rounded corners may offer better paste release. IPC-7525 may have alternate design recommendations.
9. Board assembly site may have different recommendations for stencil design.



D (R-PDSO-G8)

PLASTIC SMALL OUTLINE

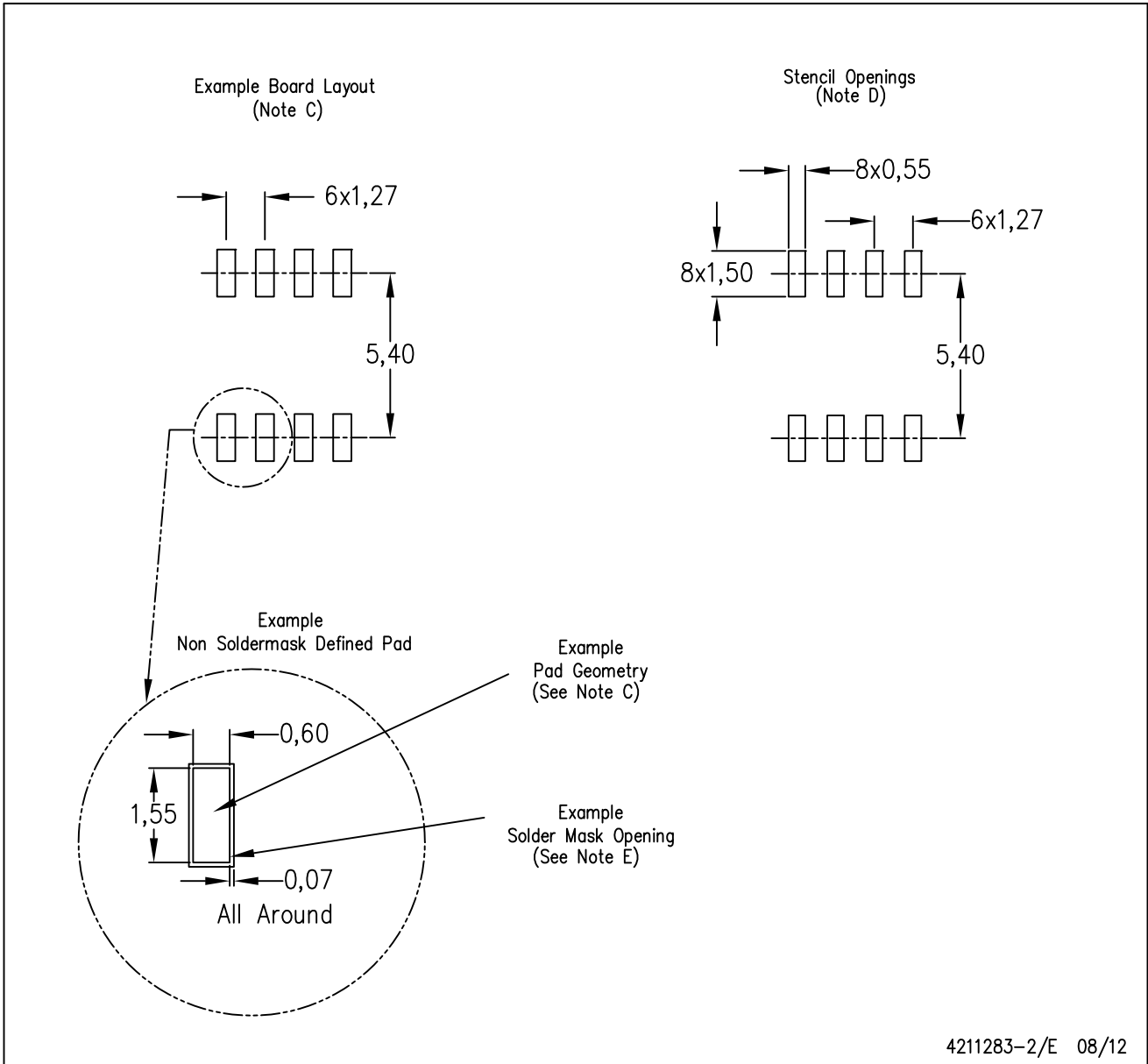

- NOTES:
- All linear dimensions are in millimeters.
  - This drawing is subject to change without notice.
  - Publication IPC-7351 is recommended for alternate designs.
  - Laser cutting apertures with trapezoidal walls and also rounding corners will offer better paste release. Customers should contact their board assembly site for stencil design recommendations. Refer to IPC-7525 for other stencil recommendations.
  - Customers should contact their board fabrication site for solder mask tolerances between and around signal pads.

## IMPORTANT NOTICE

Texas Instruments Incorporated and its subsidiaries (TI) reserve the right to make corrections, enhancements, improvements and other changes to its semiconductor products and services per JESD46, latest issue, and to discontinue any product or service per JESD48, latest issue. Buyers should obtain the latest relevant information before placing orders and should verify that such information is current and complete. All semiconductor products (also referred to herein as "components") are sold subject to TI's terms and conditions of sale supplied at the time of order acknowledgment.

TI warrants performance of its components to the specifications applicable at the time of sale, in accordance with the warranty in TI's terms and conditions of sale of semiconductor products. Testing and other quality control techniques are used to the extent TI deems necessary to support this warranty. Except where mandated by applicable law, testing of all parameters of each component is not necessarily performed.

TI assumes no liability for applications assistance or the design of Buyers' products. Buyers are responsible for their products and applications using TI components. To minimize the risks associated with Buyers' products and applications, Buyers should provide adequate design and operating safeguards.

TI does not warrant or represent that any license, either express or implied, is granted under any patent right, copyright, mask work right, or other intellectual property right relating to any combination, machine, or process in which TI components or services are used. Information published by TI regarding third-party products or services does not constitute a license to use such products or services or a warranty or endorsement thereof. Use of such information may require a license from a third party under the patents or other intellectual property of the third party, or a license from TI under the patents or other intellectual property of TI.

Reproduction of significant portions of TI information in TI data books or data sheets is permissible only if reproduction is without alteration and is accompanied by all associated warranties, conditions, limitations, and notices. TI is not responsible or liable for such altered documentation. Information of third parties may be subject to additional restrictions.

Resale of TI components or services with statements different from or beyond the parameters stated by TI for that component or service voids all express and any implied warranties for the associated TI component or service and is an unfair and deceptive business practice. TI is not responsible or liable for any such statements.

Buyer acknowledges and agrees that it is solely responsible for compliance with all legal, regulatory and safety-related requirements concerning its products, and any use of TI components in its applications, notwithstanding any applications-related information or support that may be provided by TI. Buyer represents and agrees that it has all the necessary expertise to create and implement safeguards which anticipate dangerous consequences of failures, monitor failures and their consequences, lessen the likelihood of failures that might cause harm and take appropriate remedial actions. Buyer will fully indemnify TI and its representatives against any damages arising out of the use of any TI components in safety-critical applications.

In some cases, TI components may be promoted specifically to facilitate safety-related applications. With such components, TI's goal is to help enable customers to design and create their own end-product solutions that meet applicable functional safety standards and requirements. Nonetheless, such components are subject to these terms.

No TI components are authorized for use in FDA Class III (or similar life-critical medical equipment) unless authorized officers of the parties have executed a special agreement specifically governing such use.

Only those TI components which TI has specifically designated as military grade or "enhanced plastic" are designed and intended for use in military/aerospace applications or environments. Buyer acknowledges and agrees that any military or aerospace use of TI components which have **not** been so designated is solely at the Buyer's risk, and that Buyer is solely responsible for compliance with all legal and regulatory requirements in connection with such use.

TI has specifically designated certain components as meeting ISO/TS16949 requirements, mainly for automotive use. In any case of use of non-designated products, TI will not be responsible for any failure to meet ISO/TS16949.

### Products

Audio	<a href="http://www.ti.com/audio">www.ti.com/audio</a>
Amplifiers	<a href="http://amplifier.ti.com">amplifier.ti.com</a>
Data Converters	<a href="http://dataconverter.ti.com">dataconverter.ti.com</a>
DLP® Products	<a href="http://www.dlp.com">www.dlp.com</a>
DSP	<a href="http://dsp.ti.com">dsp.ti.com</a>
Clocks and Timers	<a href="http://www.ti.com/clocks">www.ti.com/clocks</a>
Interface	<a href="http://interface.ti.com">interface.ti.com</a>
Logic	<a href="http://logic.ti.com">logic.ti.com</a>
Power Mgmt	<a href="http://power.ti.com">power.ti.com</a>
Microcontrollers	<a href="http://microcontroller.ti.com">microcontroller.ti.com</a>
RFID	<a href="http://www.ti-rfid.com">www.ti-rfid.com</a>
OMAP Applications Processors	<a href="http://www.ti.com/omap">www.ti.com/omap</a>
Wireless Connectivity	<a href="http://www.ti.com/wirelessconnectivity">www.ti.com/wirelessconnectivity</a>

### Applications

Automotive and Transportation	<a href="http://www.ti.com/automotive">www.ti.com/automotive</a>
Communications and Telecom	<a href="http://www.ti.com/communications">www.ti.com/communications</a>
Computers and Peripherals	<a href="http://www.ti.com/computers">www.ti.com/computers</a>
Consumer Electronics	<a href="http://www.ti.com/consumer-apps">www.ti.com/consumer-apps</a>
Energy and Lighting	<a href="http://www.ti.com/energy">www.ti.com/energy</a>
Industrial	<a href="http://www.ti.com/industrial">www.ti.com/industrial</a>
Medical	<a href="http://www.ti.com/medical">www.ti.com/medical</a>
Security	<a href="http://www.ti.com/security">www.ti.com/security</a>
Space, Avionics and Defense	<a href="http://www.ti.com/space-avionics-defense">www.ti.com/space-avionics-defense</a>
Video and Imaging	<a href="http://www.ti.com/video">www.ti.com/video</a>

### TI E2E Community

[e2e.ti.com](http://e2e.ti.com)