

## TPA6133A2 138-mW DirectPath™ Stereo Headphone Amplifier

### 1 Features

- DirectPath™ Ground-Referenced Outputs
  - Eliminates Output DC Blocking Capacitors
  - Reduces Board Area
  - Reduces Component Height and Cost
  - Full Bass Response Without Attenuation
- Power Supply Voltage Range: 2.5 V to 5.5 V
- High Power Supply Rejection Ratio (>100 dB PSRR)
- Differential Inputs for Maximum Noise Rejection (69 dB CMRR)
- High-Impedance Outputs When Disabled
- Advanced Pop and Click Suppression Circuitry
- GPIO Control for Shutdown
- 20 Pin, 4 mm x 4 mm WQFN Package

### 2 Applications

- Mobile Phones
- Audio Headsets
- Notebook Computers
- High Fidelity Applications

### 4 Simplified Application Diagram

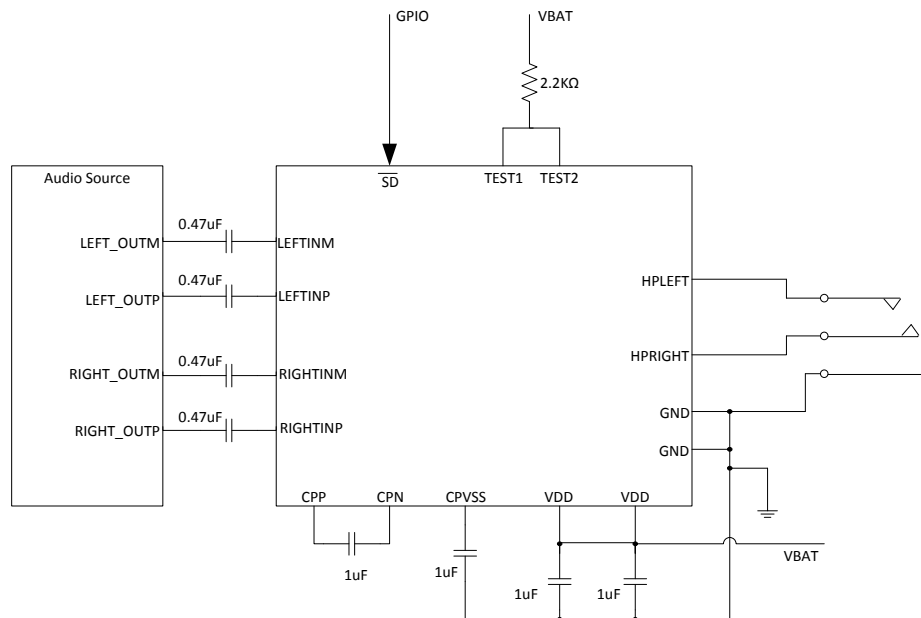

### 3 Description

The TPA6133A2 is a stereo DirectPath™ headphone amplifier with GPIO control. The TPA6133A2 has minimal quiescent current consumption, with a typical  $I_{DD}$  of 4.2 mA, making it optimal for portable applications. The GPIO control allows the device to be put in a low power shutdown mode.

The TPA6133A2 is a high fidelity amplifier with an SNR of 93 dB. A PSRR greater than 100 dB enables direct-to-battery connections without compromising the listening experience. The output noise of 12  $\mu\text{Vrms}$  (typical *A-weighted*) provides a minimal noise background during periods of silence. Configurable differential inputs and high CMRR allow for maximum noise rejection in the noisy environment of a mobile device.

#### Device Information<sup>(1)</sup>

PART NUMBER	PACKAGE	BODY SIZE (NOM)
TPA6133A2	WQFN (20)	4.00 mm x 4.00 mm

(1) For all available packages, see the orderable addendum at the end of the datasheet.



## Table of Contents

<b>1 Features</b> .....	<b>1</b>	8.2 Functional Block Diagram .....	<b>10</b>
<b>2 Applications</b> .....	<b>1</b>	8.3 Feature Description .....	<b>11</b>
<b>3 Description</b> .....	<b>1</b>	8.4 Device Functional Modes .....	<b>12</b>
<b>4 Simplified Application Diagram</b> .....	<b>1</b>	<b>9 Application and Implementation</b> .....	<b>13</b>
<b>5 Revision History</b> .....	<b>2</b>	9.1 Application Information .....	<b>13</b>
<b>6 Pin Configuration and Functions</b> .....	<b>3</b>	9.2 Typical Application .....	<b>13</b>
<b>7 Specification</b> .....	<b>4</b>	<b>10 Power Supply Recommendations</b> .....	<b>16</b>
7.1 Absolute Maximum Ratings .....	<b>4</b>	<b>11 Layout</b> .....	<b>17</b>
7.2 Handling Ratings .....	<b>4</b>	11.1 Layout Guidelines .....	<b>17</b>
7.3 Recommended Operating Conditions .....	<b>4</b>	11.2 Layout Example .....	<b>17</b>
7.4 Thermal Information .....	<b>4</b>	<b>12 Device and Documentation Support</b> .....	<b>18</b>
7.5 Electrical Characteristics .....	<b>5</b>	12.1 Trademarks .....	<b>18</b>
7.6 Operating Characteristics .....	<b>5</b>	12.2 Electrostatic Discharge Caution .....	<b>18</b>
7.7 Typical Characteristics .....	<b>6</b>	12.3 Glossary .....	<b>18</b>
<b>8 Detailed Description</b> .....	<b>10</b>	<b>13 Mechanical, Packaging, and Orderable Information</b> .....	<b>18</b>
8.1 Overview .....	<b>10</b>		

## 5 Revision History

NOTE: Page numbers for previous revisions may differ from page numbers in the current version.

### Changes from Revision A (August 2014) to Revision B

Page

• Changed "PIN QFN" To: "NUMBER" in the Pin Functions table .....	<b>3</b>
• Added a NOTE to the Applications and Implementation section .....	<b>13</b>
• Added new paragraph to the Application Information section .....	<b>13</b>

### Changes from Original (June 2013) to Revision A

Page

• Added Handling Rating table, Feature Description section, Device Functional Modes, Application and Implementation section, Power Supply Recommendations section, Layout section, Device and Documentation Support section, and Mechanical, Packaging, and Orderable Information section .....	<b>1</b>
• Added the Device Information Table .....	<b>1</b>
• Moved "Minimum Load Impedance" From the Absolute Maximum Ratings table To the Recommended Operating Conditions table .....	<b>4</b>
• Added the Thermal Information Table .....	<b>4</b>
• Changed text in the Overview section From: "toggling the $\overline{SD}$ pin to logic 1." To: "asserting the $\overline{SD}$ pin to logic 1." .....	<b>10</b>
• Changed text in the Headphone Amplifier section From: "the output signal is severely clipped" To: "power consumption will be higher" .....	<b>11</b>
• Added the Optional Test Setup section .....	<b>15</b>
• Added the Layout Example image .....	<b>17</b>

## 6 Pin Configuration and Functions

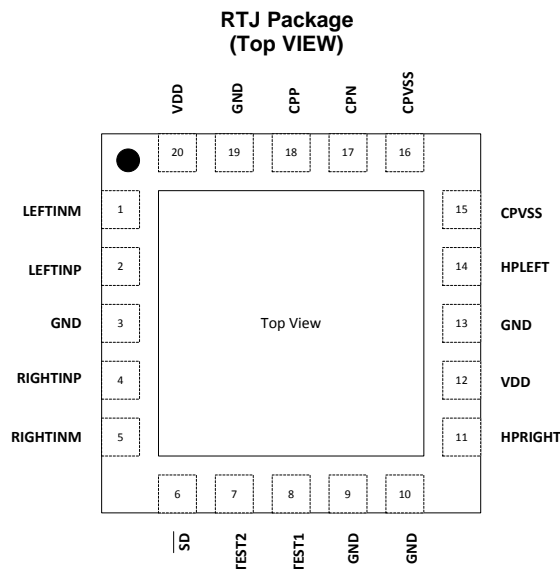

### Pin Functions

PIN		INPUT, OUTPUT, POWER	DESCRIPTION
NAME	NUMBER		
LEFTINM	1	I	Left channel negative differential input. Impedance must be matched to LEFTINP. Connect the left input to LEFTINM when using single-ended inputs.
LEFTINP	2	I	Left channel positive differential input. Impedance must be matched to LEFTINM. AC ground LEFTINP near signal source while maintaining matched impedance to LEFTINM when using single-ended inputs.
RIGHTINP	4	I	Right channel positive differential input. Impedance must be matched to RIGHTINM. AC ground RIGHTINP near signal source while maintaining matched impedance to RIGHTINM when using single-ended inputs.
GND	3, 9, 10, 13	P	Analog ground. Must be connected to common supply GND. It is recommended that this pin be used to decouple $V_{DD}$ for analog. Use pin 13 to decouple pin 12 on the QFN package.
RIGHTINM	5	I	Right channel negative differential input. Impedance must be matched to RIGHTINP. Connect the right input to RIGHTINM when using single-ended inputs.
$\overline{SD}$	6	I	Shutdown. Active low logic. 5V tolerant input.
TEST2	7	I	Factory test pins. Pull up to $V_{DD}$ supply. See Applications Diagram.
TEST1	8	I	Factory test pins. Pull up to $V_{DD}$ supply. See Applications Diagram.
HPRIGHT	11	O	Headphone light channel output. Connect to the right terminal of the headphone jack.
$V_{DD}$	12	P	Analog $V_{DD}$ . $V_{DD}$ must be connected to common $V_{DD}$ supply. Decouple with its own 1- $\mu$ F capacitor to analog ground (pin 13).
HPLEFT	14	O	Headphone left channel output. Connect to left terminal of headphone jack.
CPVSS	15, 16	P	Negative supply generated by the charge pump. Decouple to pin 19 or a GND plane. Use a 1 $\mu$ F capacitor.
CPN	17	P	Charge pump flying capacitor negative terminal. Connect one side of the flying capacitor to CPN.
CPP	18	P	Charge pump flying capacitor positive terminal. Connect one side of the flying capacitor to CPP.
GND	19	P	Charge pump ground. GND must be connected to common supply GND. It is recommended that this pin be decoupled to the $V_{DD}$ of the charge pump pin (pin 20 on the QFN).
$V_{DD}$	20	P	Charge pump voltage supply. $V_{DD}$ must be connected to the common $V_{DD}$ voltage supply. Decouple to GND (pin 19) with its own 1 $\mu$ F capacitor.
Thermal pad	Die Pad	P	Solder the thermal pad on the bottom of the QFN package to the GND plane of the PCB. It is required for mechanical stability and will enhance thermal performance.

## 7 Specification

### 7.1 Absolute Maximum Ratings<sup>(1)</sup>

over operating free-air temperature range,  $T_A = 25^\circ\text{C}$  (unless otherwise noted)

		MIN	MAX	UNIT
Supply voltage, $V_{DD}$		-0.3	6	V
Input voltage	RIGHTINx, LEFTINx	CPVSS-0.2 V to minimum of (3.6 V, $V_{DD}+0.2$ V)		
	$\overline{SD}$ , TEST1, TEST2	-0.3	7	V
Output continuous total power dissipation		See the <a href="#">Thermal Information</a> Table		
Operating free-air temperature range, $T_A$		-40	85	$^\circ\text{C}$
Operating junction temperature range, $T_J$		-40	150	$^\circ\text{C}$

(1) Stresses beyond those listed under *absolute maximum ratings* may cause permanent damage to the device. These are stress ratings only, and functional operation of the device at these or any other conditions beyond those indicated under *recommended operating conditions* is not implied. Exposure to absolute-maximum-rated conditions for extended periods may affect device reliability.

### 7.2 Handling Ratings

			MIN	MAX	UNIT
$T_{stg}$	Storage temperature range		-65	150	$^\circ\text{C}$
$V_{(ESD)}$	Electrostatic discharge	Human body model (HBM), per ANSI/ESDA/JEDEC JS-001, all pins <sup>(1)</sup>	-3	3	kV
		Charged device model (CDM), per JEDEC specification JESD22-C101, all pins <sup>(2)</sup>	-750	750	V

(1) JEDEC document JEP155 states that 500-V HBM allows safe manufacturing with a standard ESD control process.

(2) JEDEC document JEP157 states that 250-V CDM allows safe manufacturing with a standard ESD control process.

### 7.3 Recommended Operating Conditions

			MIN	MAX	UNIT
Supply voltage, $V_{DD}$			2.5	5.5	V
$V_{IH}$	High-level input voltage	TEST1, TEST2, $\overline{SD}$	1.3		V
$V_{IL}$	Low-level input voltage	$\overline{SD}$		0.35	V
Minimum Load Impedance			12.8		$\Omega$
$T_A$	Operating free-air temperature		-40	85	$^\circ\text{C}$

### 7.4 Thermal Information

THERMAL METRIC <sup>(1)</sup>		RTJ	UNIT
		20 PINS	
$R_{\theta JA}$	Junction-to-ambient thermal resistance	34.8	$^\circ\text{C}/\text{W}$
$R_{\theta JC(top)}$	Junction-to-case (top) thermal resistance	32.5	
$R_{\theta JB}$	Junction-to-board thermal resistance	11.6	
$\Psi_{JT}$	Junction-to-top characterization parameter	0.4	
$\Psi_{JB}$	Junction-to-board characterization parameter	11.6	
$R_{\theta JC(bot)}$	Junction-to-case (bottom) thermal resistance	3.1	

(1) For more information about traditional and new thermal metrics, see the *IC Package Thermal Metrics* application report, [SPRA953](#).

## 7.5 Electrical Characteristics

 $T_A = 25^\circ\text{C}$  (unless otherwise noted)

PARAMETER		TEST CONDITIONS	MIN	TYP	MAX	UNIT
$ V_{OS} $	Output offset voltage	$V_{DD} = 2.5\text{ V to }5.5\text{ V}$ , inputs grounded		135	400	$\mu\text{V}$
PSRR	DC Power supply rejection ratio	$V_{DD} = 2.5\text{ V to }5.5\text{ V}$ , inputs grounded		-101	-85	dB
CMRR	Common mode rejection ratio	$V_{DD} = 2.5\text{ V to }5.5\text{ V}$		-69		dB
$ I_{IH} $	High-level input current	$V_{DD} = 5.5\text{ V}$ , $V_I = V_{DD}$	TEST1, TEST2		1	$\mu\text{A}$
			$\overline{SD}$		10	
$ I_{IL} $	Low-level input current	$V_{DD} = 5.5\text{ V}$ , $V_I = 0\text{ V}$			1	$\mu\text{A}$
$I_{DD}$	Supply current	$V_{DD} = 2.5\text{ V to }5.5\text{ V}$ , $\overline{SD} = V_{DD}$		4.2	6	mA
		Shutdown mode, $V_{DD} = 2.5\text{ V to }5.5\text{ V}$ , $\overline{SD} = 0\text{ V}$		0.08	1	$\mu\text{A}$

## 7.6 Operating Characteristics

 $V_{DD} = 3.6\text{ V}$ ,  $T_A = 25^\circ\text{C}$ ,  $R_L = 16\ \Omega$  (unless otherwise noted)

PARAMETER		TEST CONDITIONS	MIN	TYP	MAX	UNIT
$P_O$	Output power	Stereo, Outputs out of phase, THD = 1%, $f = 1\text{ kHz}$ , Gain = +4 dB	$V_{DD} = 2.5\text{ V}$	63		mW
			$V_{DD} = 3.6\text{ V}$	133		
			$V_{DD} = 5\text{ V}$	142		
THD+N	Total harmonic distortion plus noise	$P_O = 35\text{ mW}$	$f = 100\text{ Hz}$	0.0096%		
			$f = 1\text{ kHz}$	0.007%		
			$f = 20\text{ kHz}$	0.0021%		
$k_{SVR}$	Supply ripple rejection ratio	200 mV <sub>pp</sub> ripple, $f = 217\text{ Hz}$		-94.3	-85	dB
		200 mV <sub>pp</sub> ripple, $f = 1\text{ kHz}$		-92		
		200 mV <sub>pp</sub> ripple, $f = 20\text{ kHz}$		-77.1		
$A_V$	Channel DC Gain	$\overline{SD} = V_{DD}$		1.597		V/V
$\Delta A_V$	Gain matching			0.1%		
	Slew rate			0.4		V/ $\mu\text{s}$
$V_n$	Noise output voltage	$V_{DD} = 3.6\text{ V}$ , A-weighted, Gain = +4 dB		12		$\mu\text{V}_{RMS}$
$f_{osc}$	Charge pump switching frequency		300	381	500	kHz
	Start-up time from shutdown			4.8		ms
	Differential input impedance			36.6		k $\Omega$
SNR	Signal-to-noise ratio	$P_O = 35\text{ mW}$		93		dB
	Thermal shutdown	Threshold		180		$^\circ\text{C}$
		Hysteresis		35		$^\circ\text{C}$
$Z_O$	HW Shutdown HP output impedance	$\overline{SD} = 0\text{ V}$ , measured output to ground.		112		$\Omega$
$C_O$	Output capacitance			80		pF

## 7.7 Typical Characteristics

Table 1. Table of Graphs

		Figure
Total harmonic distortion + noise	versus Output power	Figure 1–Figure 4
Total harmonic distortion + noise	versus Frequency	Figure 5–Figure 12
Supply voltage rejection ratio	versus Frequency	Figure 13–Figure 14
Common mode rejection ratio	versus Frequency	Figure 15–Figure 16
Crosstalk	versus Frequency	Figure 17–Figure 18

$C_{(PUMP, DECOUPLE, \text{,}BYPASS, CPVSS)} = 1 \mu\text{F}$ ,  $C_1 = 2.2 \mu\text{F}$ .

All THD + N graphs taken with outputs out of phase (unless otherwise noted).

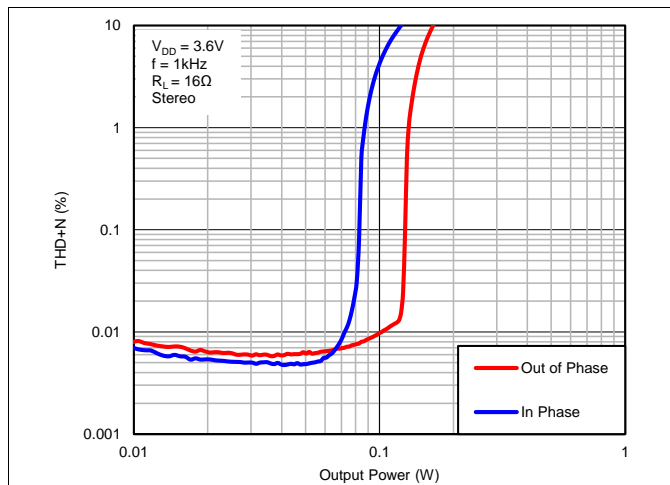

Figure 1. Total Harmonic Distortion + Noise vs Output Power

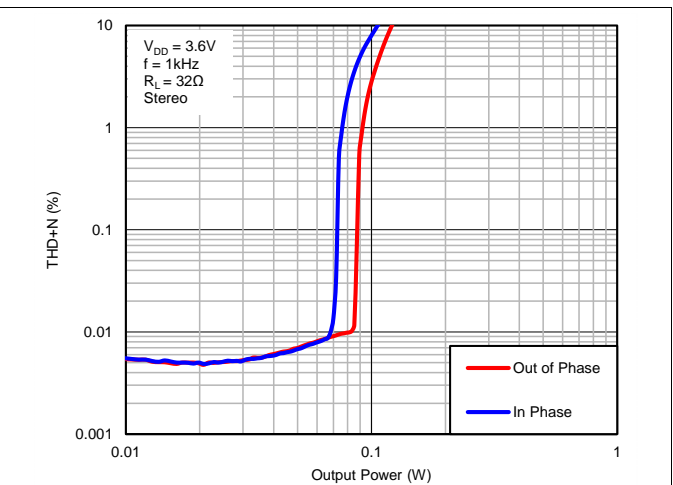

Figure 2. Total Harmonic Distortion + Noise vs Output Power

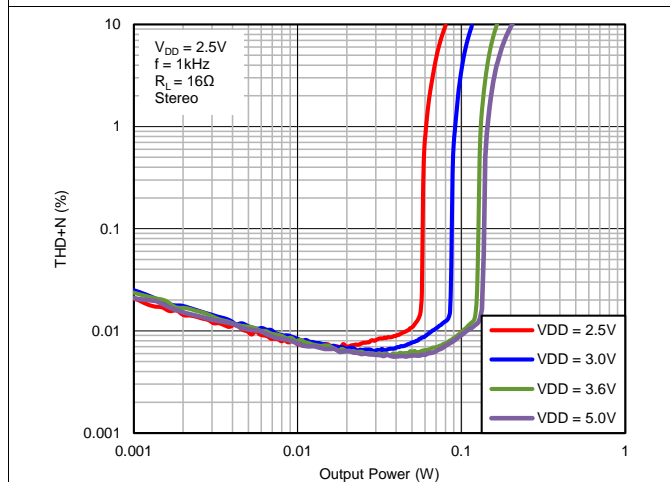

Figure 3. Total Harmonic Distortion + Noise vs Output Power

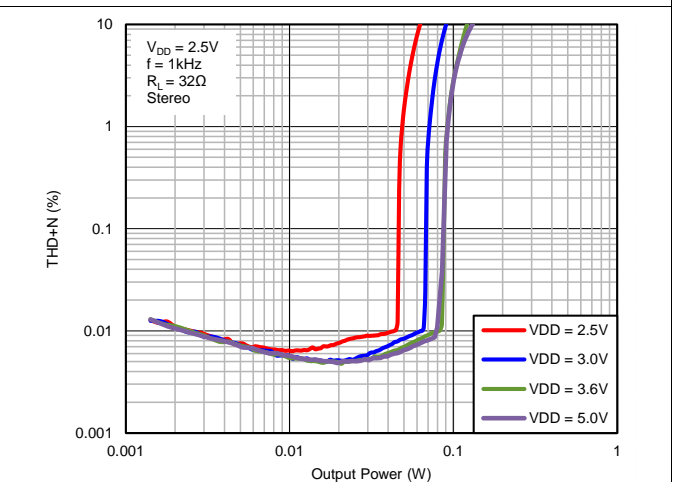

Figure 4. Total Harmonic Distortion + Noise vs Output Power

All THD + N graphs taken with outputs out of phase (unless otherwise noted).

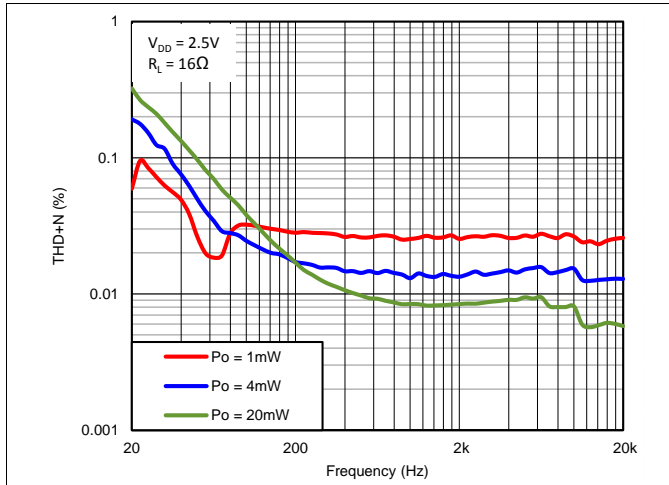

Figure 5. Total Harmonic Distortion + Noise vs Frequency

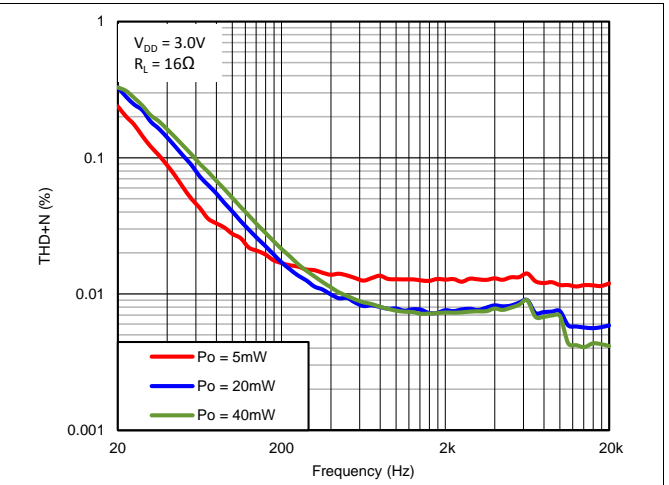

Figure 6. Total Harmonic Distortion + Noise vs Frequency

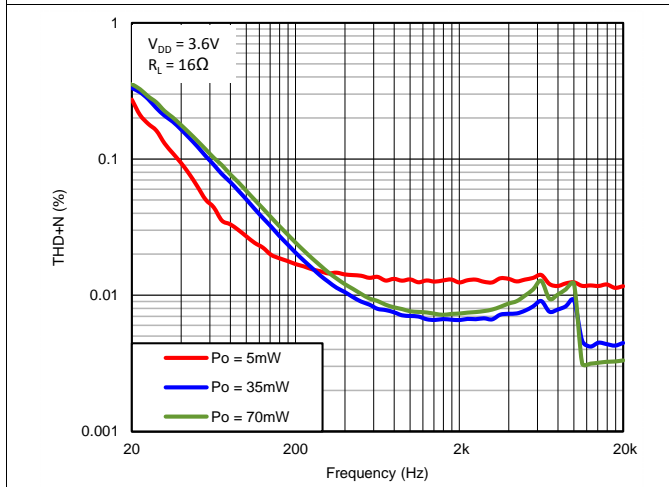

Figure 7. Total Harmonic Distortion + Noise vs Frequency

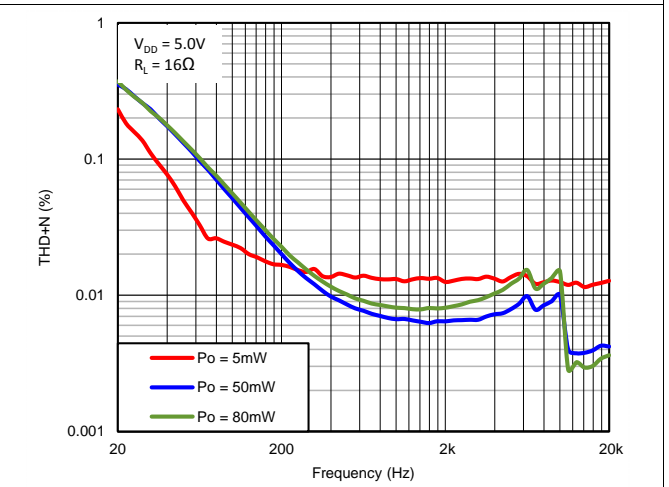

Figure 8. Total Harmonic Distortion + Noise vs Frequency

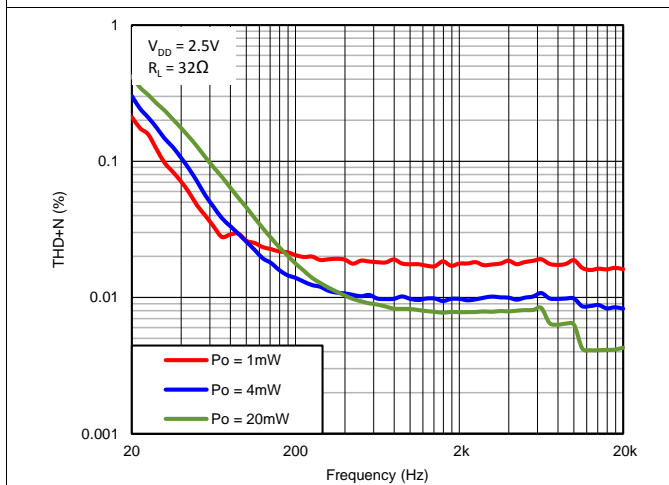

Figure 9. Total Harmonic Distortion + Noise vs Frequency

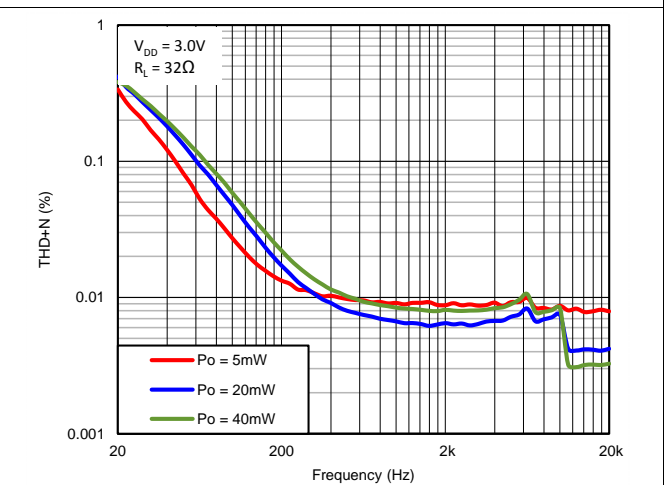
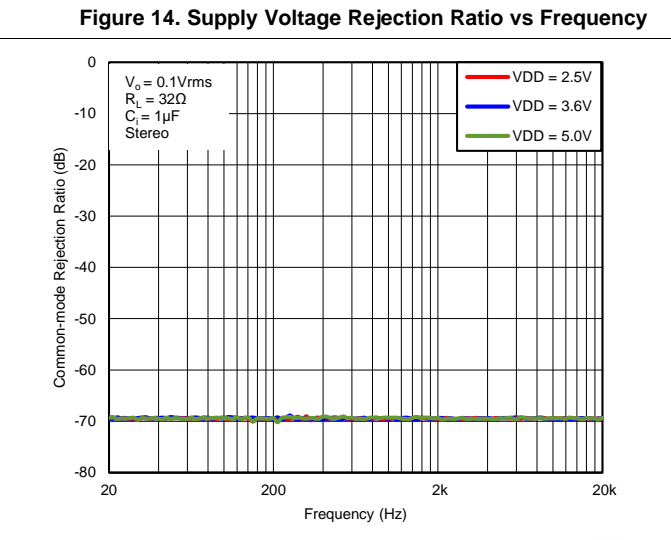
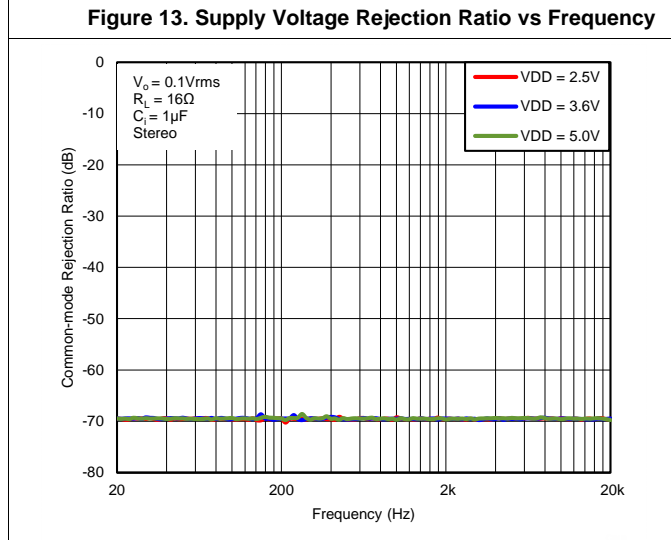
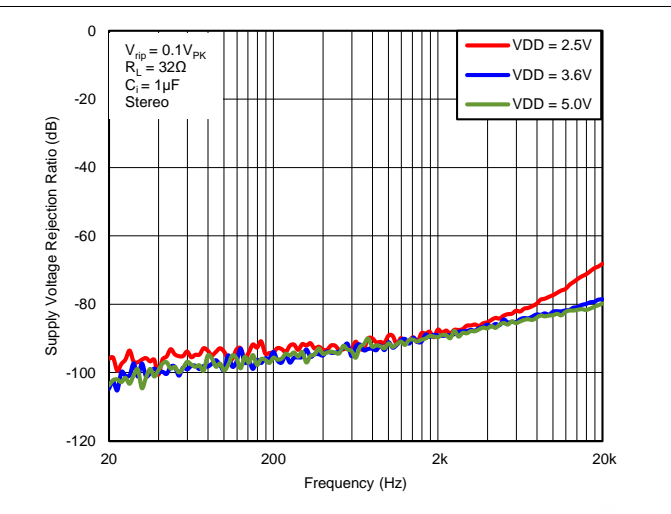
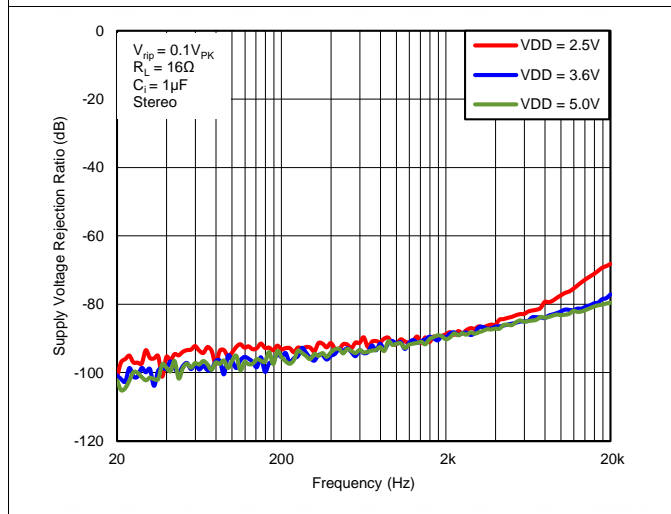
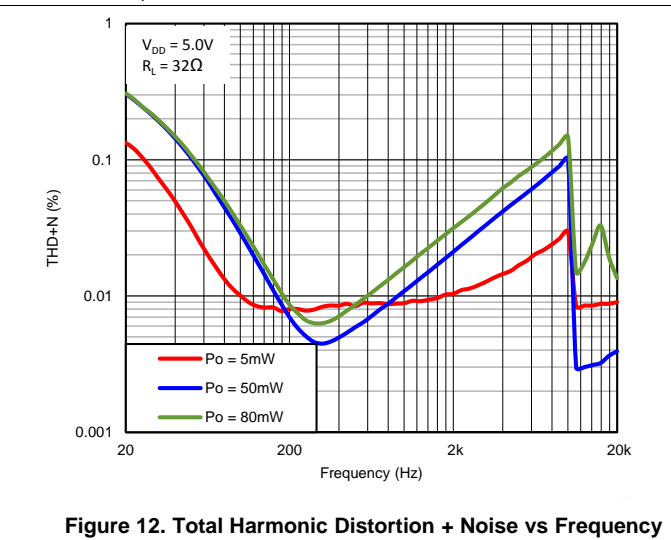
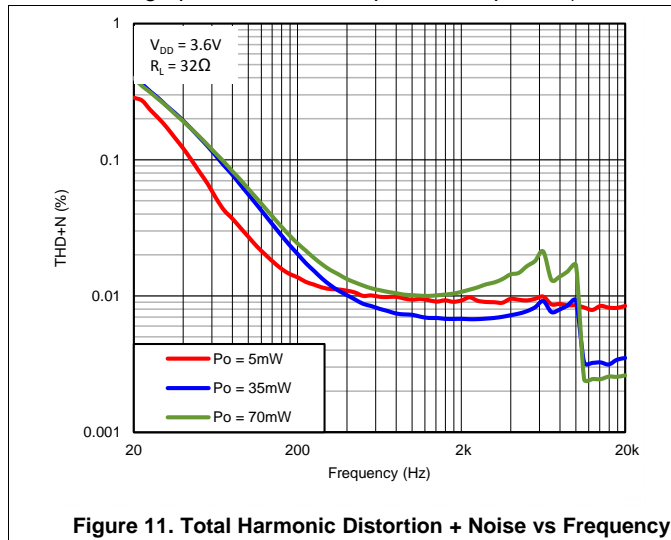
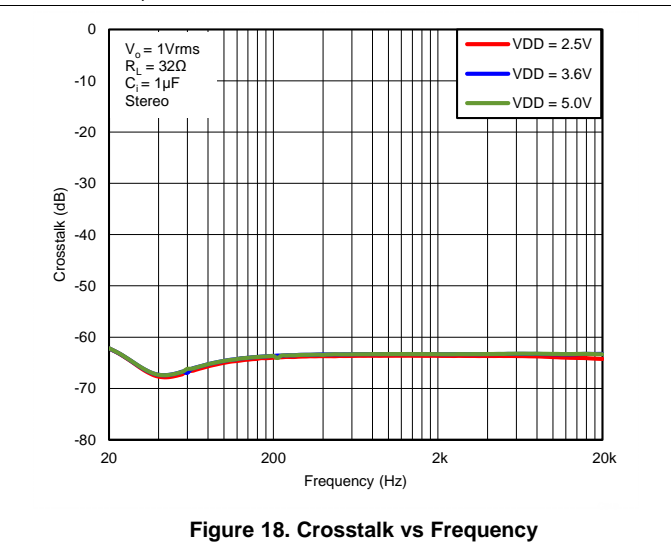
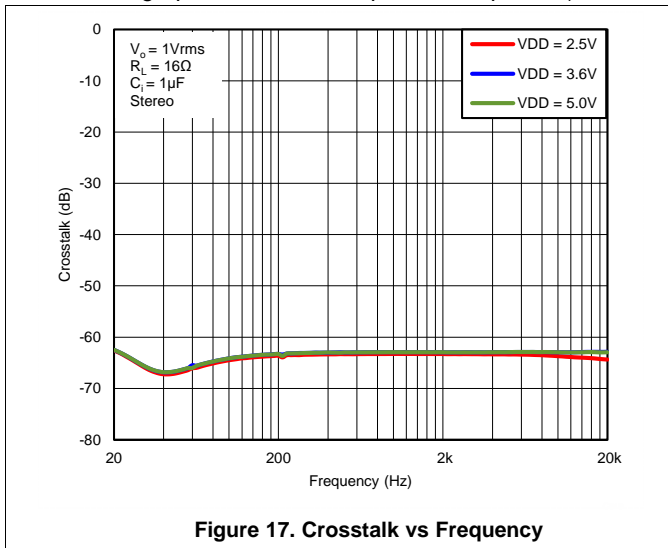

Figure 10. Total Harmonic Distortion + Noise vs Frequency

All THD + N graphs taken with outputs out of phase (unless otherwise noted).



All THD + N graphs taken with outputs out of phase (unless otherwise noted).



## 8 Detailed Description

### 8.1 Overview

Headphone channels and the charge pump are activated by asserting the  $\overline{SD}$  pin to logic 1. The charge pump generates a negative supply voltage for the output amplifiers. This allows a 0 V bias at the outputs, eliminating the need for bulky output capacitors. The thermal block detects faults and shuts down the device before damage occurs. The current limit block prevents the output current from getting high enough to damage the device. The De-Pop block eliminates audible pops during power-up, power-down, and amplifier enable and disable events.

### 8.2 Functional Block Diagram

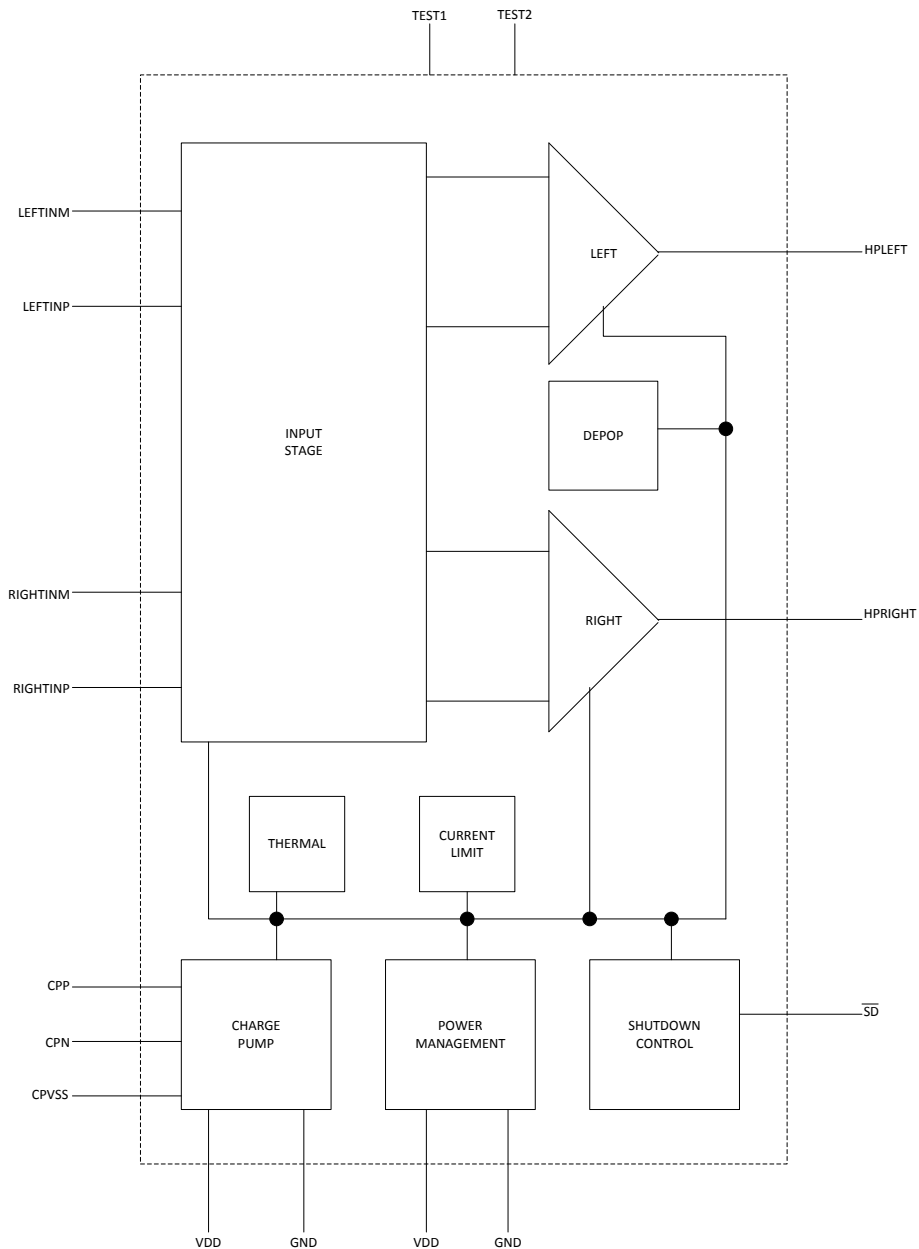

## 8.3 Feature Description

### 8.3.1 Headphone Amplifiers

Single-supply headphone amplifiers typically require dc-blocking capacitors. The capacitors are required because most headphone amplifiers have a dc bias on the outputs pin. If the dc bias is not removed, power consumption will be higher, and large amounts of dc current rush through the headphones, potentially damaging them. The top drawing in [Figure 19](#) illustrates the conventional headphone amplifier connection to the headphone jack and output signal.

DC blocking capacitors are often large in value. The headphone speakers (typical resistive values of 16  $\Omega$  or 32  $\Omega$ ) combine with the dc blocking capacitors to form a high-pass filter. [Equation 1](#) shows the relationship between the load impedance ( $R_L$ ), the capacitor ( $C_O$ ), and the cutoff frequency ( $f_c$ ).

$$f_c = \frac{1}{2\pi R_L C_O} \quad (1)$$

$C_O$  can be determined using [Equation 2](#), where the load impedance and the cutoff frequency are known.

$$C_O = \frac{1}{2\pi R_L f_c} \quad (2)$$

If  $f_c$  is low, the capacitor must then have a large value because the load resistance is small. Large capacitance values require large package sizes. Large package sizes consume PCB area, stand high above the PCB, increase cost of assembly, and can reduce the fidelity of the audio output signal.

Two different headphone amplifier applications are available that allow for the removal of the output dc blocking capacitors. The capless amplifier architecture is implemented in the same manner as the conventional amplifier with the exception of the headphone jack shield pin. This amplifier provides a reference voltage, which is connected to the headphone jack shield pin. This is the voltage on which the audio output signals are centered. This voltage reference is half of the amplifier power supply to allow symmetrical swing of the output voltages. Do not connect the shield to any GND reference or large currents will result. The scenario can happen if, for example, an accessory other than a floating GND headphone is plugged into the headphone connector. See the second block diagram and waveform in [Figure 19](#).

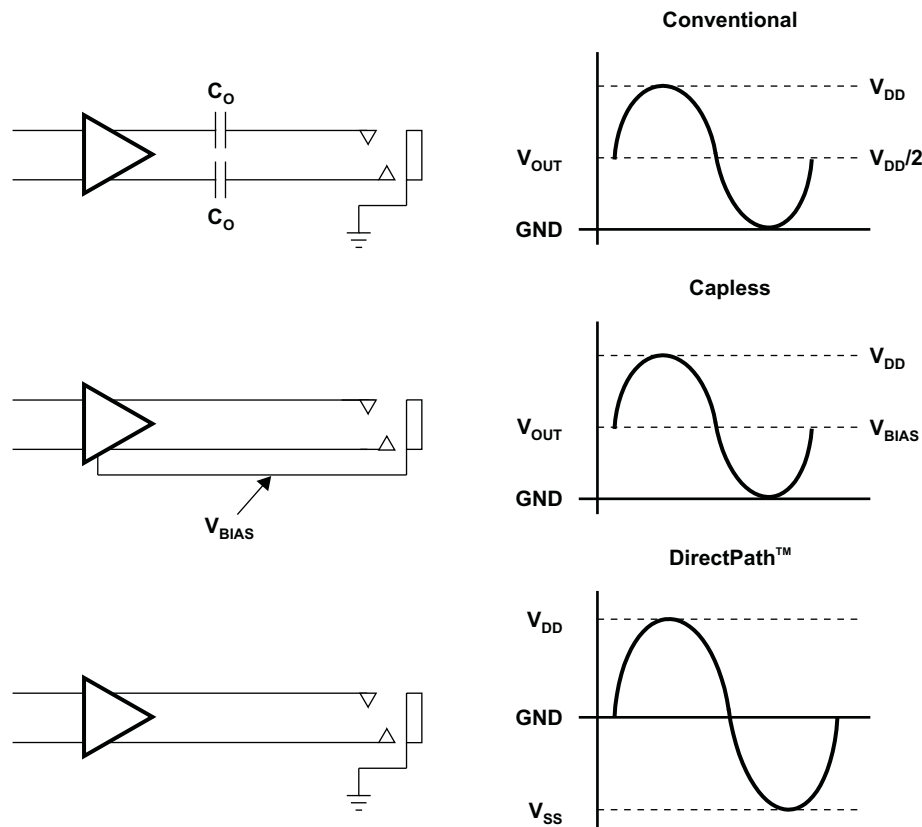
**Feature Description (continued)**

**Figure 19. Amplifier Applications**

The DirectPath™ amplifier architecture operates from a single supply but makes use of an internal charge pump to provide a negative voltage rail. Combining the user provided positive rail and the negative rail generated by the IC, the device operates in what is effectively a split supply mode. The output voltages are now centered at zero volts with the capability to swing to the positive rail or negative rail. The DirectPath™ amplifier requires no output dc blocking capacitors, and does not place any voltage on the sleeve. The bottom block diagram and waveform of [Figure 19](#) illustrate the ground-referenced headphone architecture. This is the architecture of the TPA6133A2.

**8.4 Device Functional Modes**
**8.4.1 Modes of Operation**

The TPA6133A2 supports two modes of operation. When the  $\overline{SD}$  pin is driven to logic 0, the device is in low power mode where the charge pump is powered down, the headphone channel is disabled and the outputs are pulled to ground. When the  $\overline{SD}$  pin is driven to logic 1, the device enters an active mode with charge pump powered up and headphone channel enabled with channel gain of +4dB. The transition from inactive to active and active to inactive states is done softly to avoid audible artifacts.

## 9 Application and Implementation

### NOTE

Information in the following applications sections is not part of the TI component specification, and TI does not warrant its accuracy or completeness. TI's customers are responsible for determining suitability of components for their purposes. Customers should validate and test their design implementation to confirm system functionality.

### 9.1 Application Information

The TPA6133A2 is a stereo DirectPath™ headphone amplifier with GPIO control. The TPA6133A2 has minimal quiescent current consumption, with a typical  $I_{DD}$  of 4.2 mA, making it optimal for portable applications.

### 9.2 Typical Application

Figure 20 shows a typical application circuit for the TPA6133A2 with a stereo headphone jack and supporting power supply decoupling capacitors.

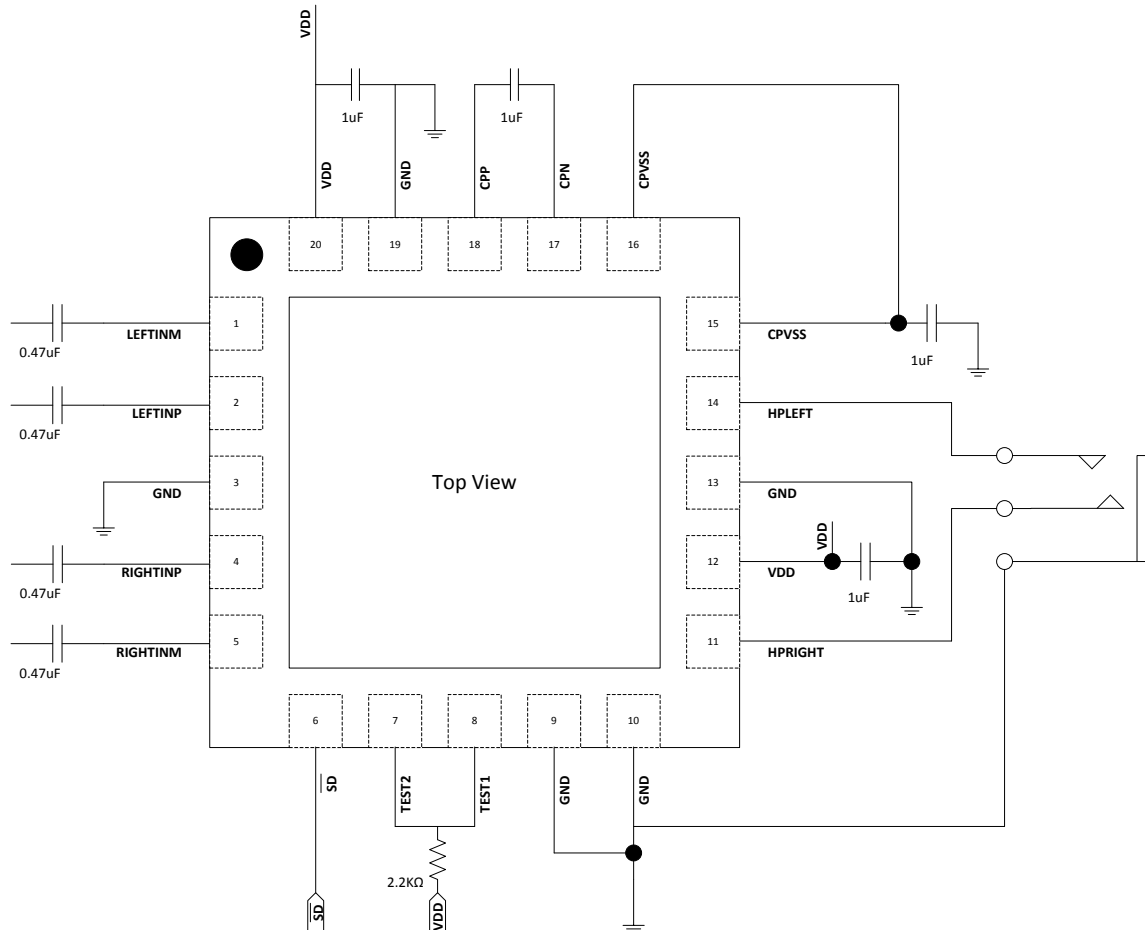

Figure 20. Simplified Applications Circuit

## Typical Application (continued)

### 9.2.1 Design Requirements

For this design example, use the following as the input parameters.

**Table 2. Design Parameters**

DESIGN PARAMETER	EXAMPLE VALUE
Input voltage	2.5 V – 5.5 V
Minimum current limit	4 mA
Maximum current limit	6 mA

### 9.2.2 Detailed Design Procedure

#### 9.2.2.1 Input-Blocking Capacitors

DC input-blocking capacitors block the dc portion of the audio source, and allow the inputs to properly bias. Maximum performance is achieved when the inputs of the TPA6133A2 are properly biased. Performance issues such as pop are optimized with proper input capacitors.

The dc input-blocking capacitors may be removed provided the inputs are connected differentially and within the input common mode range of the amplifier, the audio signal does not exceed  $\pm 3$  V, and pop performance is sufficient.

$C_{IN}$  is a theoretical capacitor used for mathematical calculations only. Its value is the series combination of the dc input-blocking capacitors,  $C_{(DCINPUT-BLOCKING)}$ . Use Equation 3 to determine the value of  $C_{(DCINPUT-BLOCKING)}$ . For example, if  $C_{IN}$  is equal to 0.22  $\mu$ F, then  $C_{(DCINPUT-BLOCKING)}$  is equal to about 0.47  $\mu$ F.

$$C_{IN} = \frac{1}{2} C_{(DCINPUT-BLOCKING)} \quad (3)$$

The two  $C_{(DCINPUT-BLOCKING)}$  capacitors form a high-pass filter with the input impedance of the TPA6133A2. Use Equation 3 to calculate  $C_{IN}$ , then calculate the cutoff frequency using  $C_{IN}$  and the differential input impedance of the TPA6133A2,  $R_{IN}$ , using Equation 4. Note that the differential input impedance changes with gain. The frequency and/or capacitance can be determined when one of the two values are given.

$$f_{C_{IN}} = \frac{1}{2\pi R_{IN} C_{IN}} \quad \text{or} \quad C_{IN} = \frac{1}{2\pi f_{C_{IN}} R_{IN}} \quad (4)$$

If a high pass filter with a -3 dB point of no more than 20 Hz is desired over all gain settings, the minimum impedance would be used in the above equation. The capacitor value by the above equation would be 0.215  $\mu$ F. However, this is  $C_{IN}$ , and the desired value is for  $C_{(DCINPUT-BLOCKING)}$ . Multiplying  $C_{IN}$  by 2 yields 0.43  $\mu$ F, which is close to the standard capacitor value of 0.47  $\mu$ F. Place 0.47  $\mu$ F capacitors at each input terminal of the TPA6133A2 to complete the filter.

#### 9.2.2.2 Charge Pump Flying Capacitor and CPVSS Capacitor

The charge pump flying capacitor serves to transfer charge during the generation of the negative supply voltage. The  $CP_{VSS}$  capacitor must be at least equal to the flying capacitor in order to allow maximum charge transfer. Low ESR capacitors are an ideal selection, and a value of 1  $\mu$ F is typical.

#### 9.2.2.3 Decoupling Capacitors

The TPA6133A2 is a DirectPath™ headphone amplifier that requires adequate power supply decoupling to ensure that the noise and total harmonic distortion (THD) are low. Use good low equivalent-series-resistance (ESR) ceramic capacitors, typically 1.0  $\mu$ F. Find the smallest package possible, and place as close as possible to the device  $V_{DD}$  lead. Placing the decoupling capacitors close to the TPA6133A2 is important for the performance of the amplifier. Use a 10  $\mu$ F or greater capacitor near the TPA6133A2 to filter lower frequency noise signals. The high PSRR of the TPA6133A2 will make the 10  $\mu$ F capacitor unnecessary in most applications.

9.2.2.4 Optional Test Setup

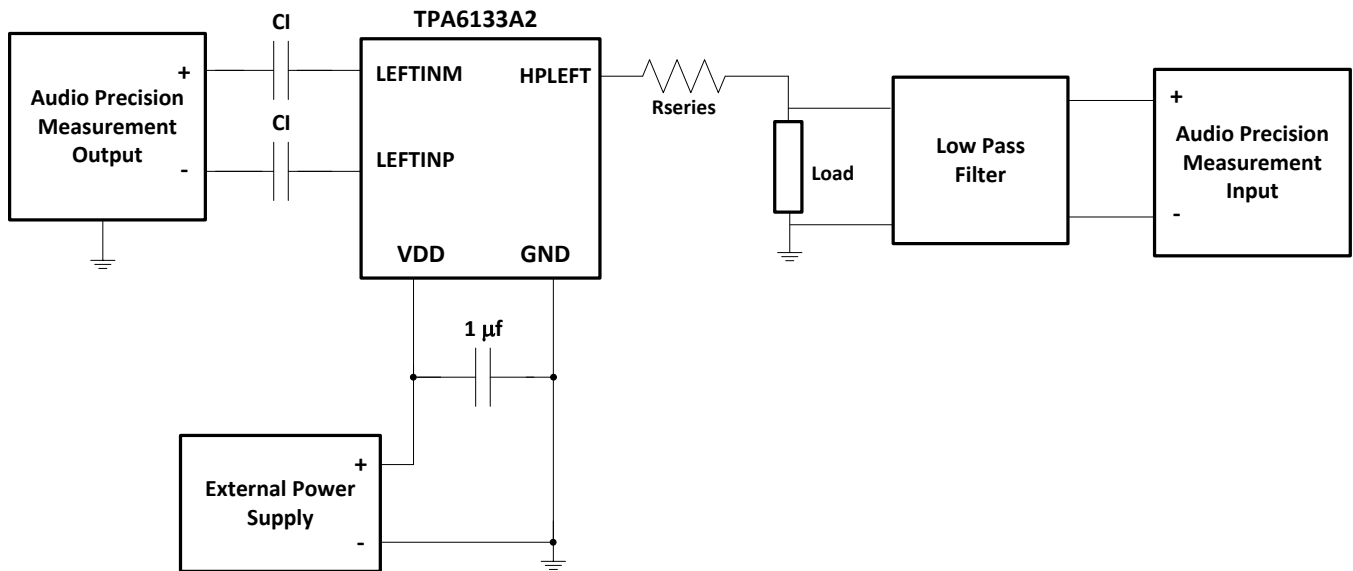
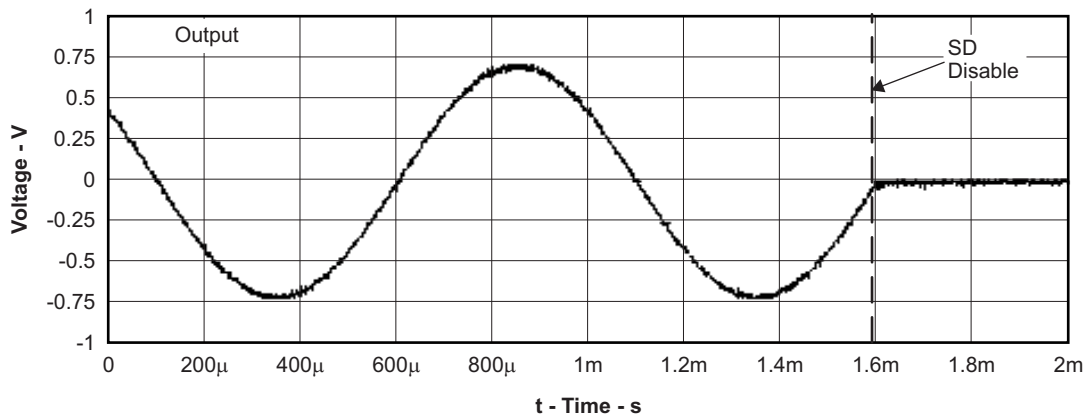

Figure 21. Test Setup

**NOTE**

Separate power supply decoupling caps are used on all VDD and CPVSS Pins  
The low pass filter is used to remove harmonic content above the audible range.

### 9.2.3 Application Curves



**Figure 22. Shutdown Time**

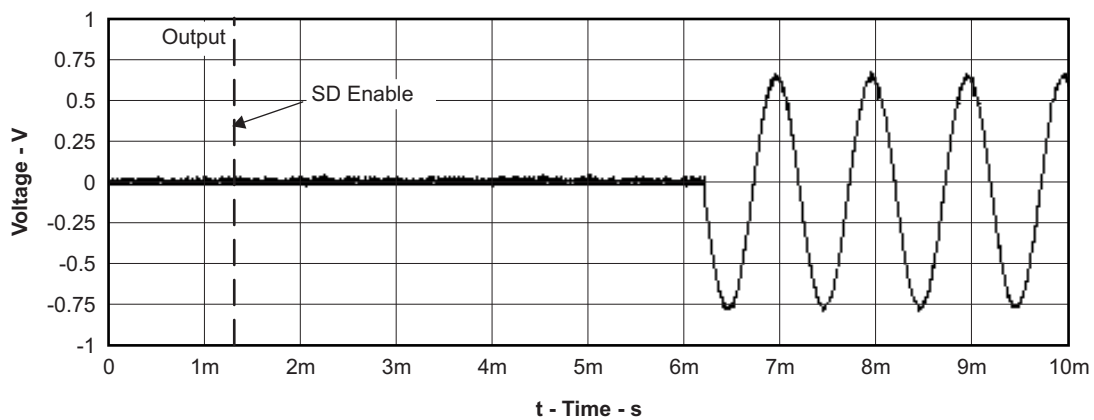

**Figure 23. Startup Time**

## 10 Power Supply Recommendations

The device is designed to operate from an input voltage supply range of 2.5 V to 5.5 V. Therefore, the output voltage range of power supply should be within this range and well regulated. The current capability of upper power should not exceed the max current limit of the power switch.

## 11 Layout

### 11.1 Layout Guidelines

#### 11.1.1 Exposed Pad On TPA6133A2RTJ Package

- Solder the exposed metal pad on the TPA6133A2RTJ QFN package to the a pad on the PCB. *The pad on the PCB may be grounded or may be allowed to float (not be connected to ground or power).*
- If the pad is grounded, it must be connected to the same ground as the GND pins (3, 9, 10, 13, and 19). See the layout and mechanical drawings at the end of the datasheet for proper sizing.
- Soldering the thermal pad improves mechanical reliability, improves grounding of the device, and enhances thermal conductivity of the package.

#### 11.1.2 GND Connections

- The GND pin for charge pump should be decoupled to the charge pump  $V_{DD}$  pin, and the GND pin adjacent to the Analog  $V_{DD}$  pin should be separately decoupled to each other.

### 11.2 Layout Example

It is recommended to place a top layer ground pour for shielding around TPA6130A2 and connect to lower main PCB ground plane by multiple vias

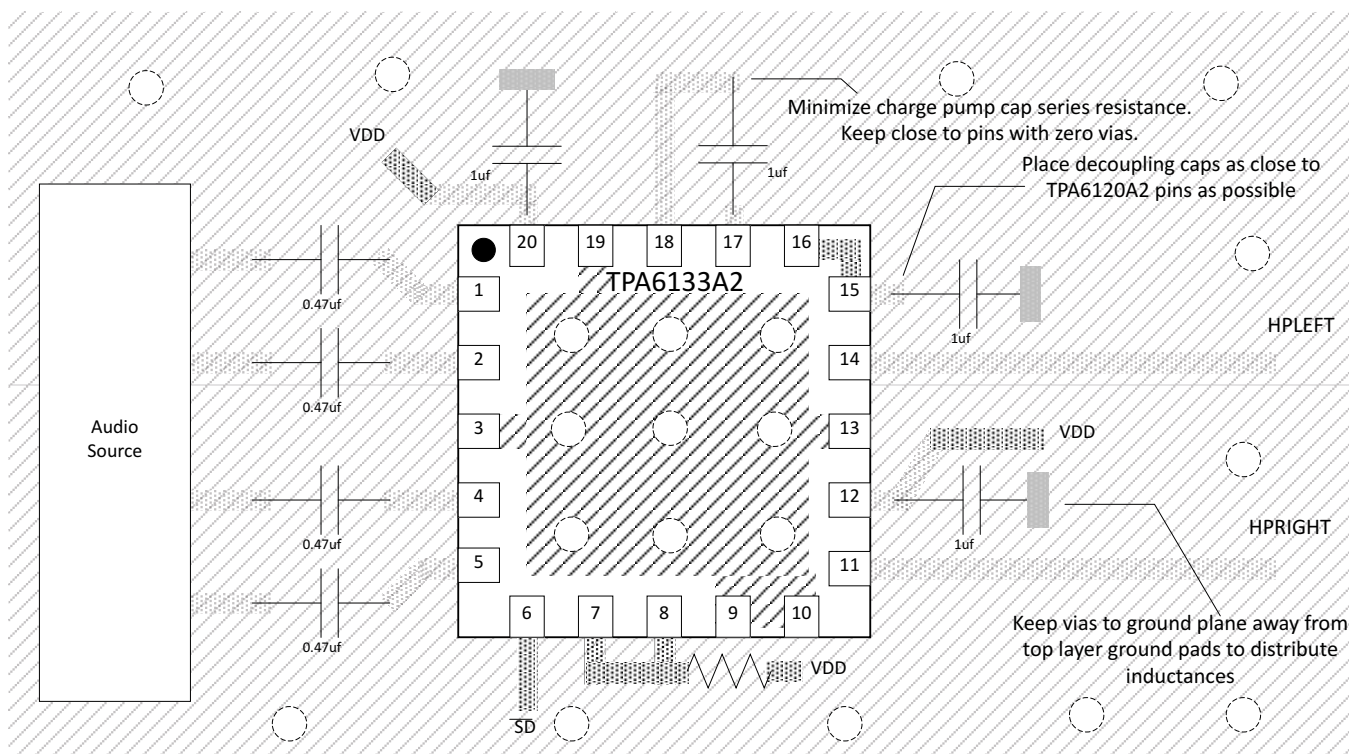

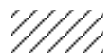
 Top Layer Ground Pour and PowerPad

 Pad to top layer ground pour

 Top Layer Signal Traces

 Via to bottom Ground Plane

## 12 Device and Documentation Support

### 12.1 Trademarks

DirectPath is a trademark of Texas Instruments.  
All other trademarks are the property of their respective owners.

### 12.2 Electrostatic Discharge Caution



These devices have limited built-in ESD protection. The leads should be shorted together or the device placed in conductive foam during storage or handling to prevent electrostatic damage to the MOS gates.

### 12.3 Glossary

[SLYZ022](#) — *TI Glossary*.

This glossary lists and explains terms, acronyms, and definitions.

## 13 Mechanical, Packaging, and Orderable Information

The following pages include mechanical, packaging, and orderable information. This information is the most current data available for the designated devices. This data is subject to change without notice and revision of this document. For browser-based versions of this data sheet, refer to the left-hand navigation.

**PACKAGING INFORMATION**

Orderable Device	Status (1)	Package Type	Package Drawing	Pins	Package Qty	Eco Plan (2)	Lead/Ball Finish (6)	MSL Peak Temp (3)	Op Temp (°C)	Device Marking (4/5)	Samples
TPA6133A2RTJR	ACTIVE	QFN	RTJ	20	3000	Green (RoHS & no Sb/Br)	CU NIPDAU	Level-2-260C-1 YEAR	-40 to 85	SIZ	<a href="#">Samples</a>
TPA6133A2RTJT	ACTIVE	QFN	RTJ	20	250	Green (RoHS & no Sb/Br)	CU NIPDAU	Level-2-260C-1 YEAR	-40 to 85	SIZ	<a href="#">Samples</a>

(1) The marketing status values are defined as follows:

**ACTIVE:** Product device recommended for new designs.

**LIFEBUY:** TI has announced that the device will be discontinued, and a lifetime-buy period is in effect.

**NRND:** Not recommended for new designs. Device is in production to support existing customers, but TI does not recommend using this part in a new design.

**PREVIEW:** Device has been announced but is not in production. Samples may or may not be available.

**OBSOLETE:** TI has discontinued the production of the device.

(2) Eco Plan - The planned eco-friendly classification: Pb-Free (RoHS), Pb-Free (RoHS Exempt), or Green (RoHS & no Sb/Br) - please check <http://www.ti.com/productcontent> for the latest availability information and additional product content details.

**TBD:** The Pb-Free/Green conversion plan has not been defined.

**Pb-Free (RoHS):** TI's terms "Lead-Free" or "Pb-Free" mean semiconductor products that are compatible with the current RoHS requirements for all 6 substances, including the requirement that lead not exceed 0.1% by weight in homogeneous materials. Where designed to be soldered at high temperatures, TI Pb-Free products are suitable for use in specified lead-free processes.

**Pb-Free (RoHS Exempt):** This component has a RoHS exemption for either 1) lead-based flip-chip solder bumps used between the die and package, or 2) lead-based die adhesive used between the die and leadframe. The component is otherwise considered Pb-Free (RoHS compatible) as defined above.

**Green (RoHS & no Sb/Br):** TI defines "Green" to mean Pb-Free (RoHS compatible), and free of Bromine (Br) and Antimony (Sb) based flame retardants (Br or Sb do not exceed 0.1% by weight in homogeneous material)

(3) MSL, Peak Temp. - The Moisture Sensitivity Level rating according to the JEDEC industry standard classifications, and peak solder temperature.

(4) There may be additional marking, which relates to the logo, the lot trace code information, or the environmental category on the device.

(5) Multiple Device Markings will be inside parentheses. Only one Device Marking contained in parentheses and separated by a "~" will appear on a device. If a line is indented then it is a continuation of the previous line and the two combined represent the entire Device Marking for that device.

(6) Lead/Ball Finish - Orderable Devices may have multiple material finish options. Finish options are separated by a vertical ruled line. Lead/Ball Finish values may wrap to two lines if the finish value exceeds the maximum column width.

**Important Information and Disclaimer:** The information provided on this page represents TI's knowledge and belief as of the date that it is provided. TI bases its knowledge and belief on information provided by third parties, and makes no representation or warranty as to the accuracy of such information. Efforts are underway to better integrate information from third parties. TI has taken and continues to take reasonable steps to provide representative and accurate information but may not have conducted destructive testing or chemical analysis on incoming materials and chemicals. TI and TI suppliers consider certain information to be proprietary, and thus CAS numbers and other limited information may not be available for release.

In no event shall TI's liability arising out of such information exceed the total purchase price of the TI part(s) at issue in this document sold by TI to Customer on an annual basis.

**TAPE AND REEL INFORMATION**

**QUADRANT ASSIGNMENTS FOR PIN 1 ORIENTATION IN TAPE**

\*All dimensions are nominal

Device	Package Type	Package Drawing	Pins	SPQ	Reel Diameter (mm)	Reel Width W1 (mm)	A0 (mm)	B0 (mm)	K0 (mm)	P1 (mm)	W (mm)	Pin1 Quadrant
TPA6133A2RTJR	QFN	RTJ	20	3000	330.0	12.4	4.25	4.25	1.15	8.0	12.0	Q2
TPA6133A2RTJR	QFN	RTJ	20	3000	330.0	12.4	4.35	4.35	1.1	8.0	12.0	Q2
TPA6133A2RTJR	QFN	RTJ	20	3000	330.0	12.4	4.25	4.25	1.15	8.0	12.0	Q2
TPA6133A2RTJT	QFN	RTJ	20	250	180.0	12.5	4.35	4.35	1.1	8.0	12.0	Q2
TPA6133A2RTJT	QFN	RTJ	20	250	180.0	12.4	4.25	4.25	1.15	8.0	12.0	Q2
TPA6133A2RTJT	QFN	RTJ	20	250	180.0	12.4	4.25	4.25	1.15	8.0	12.0	Q2

**TAPE AND REEL BOX DIMENSIONS**



\*All dimensions are nominal

Device	Package Type	Package Drawing	Pins	SPQ	Length (mm)	Width (mm)	Height (mm)
TPA6133A2RTJR	QFN	RTJ	20	3000	367.0	367.0	35.0
TPA6133A2RTJR	QFN	RTJ	20	3000	338.0	355.0	50.0
TPA6133A2RTJR	QFN	RTJ	20	3000	367.0	367.0	35.0
TPA6133A2RTJT	QFN	RTJ	20	250	338.0	355.0	50.0
TPA6133A2RTJT	QFN	RTJ	20	250	210.0	185.0	35.0
TPA6133A2RTJT	QFN	RTJ	20	250	210.0	185.0	35.0

# MECHANICAL DATA

RTJ (S-PWQFN-N20)

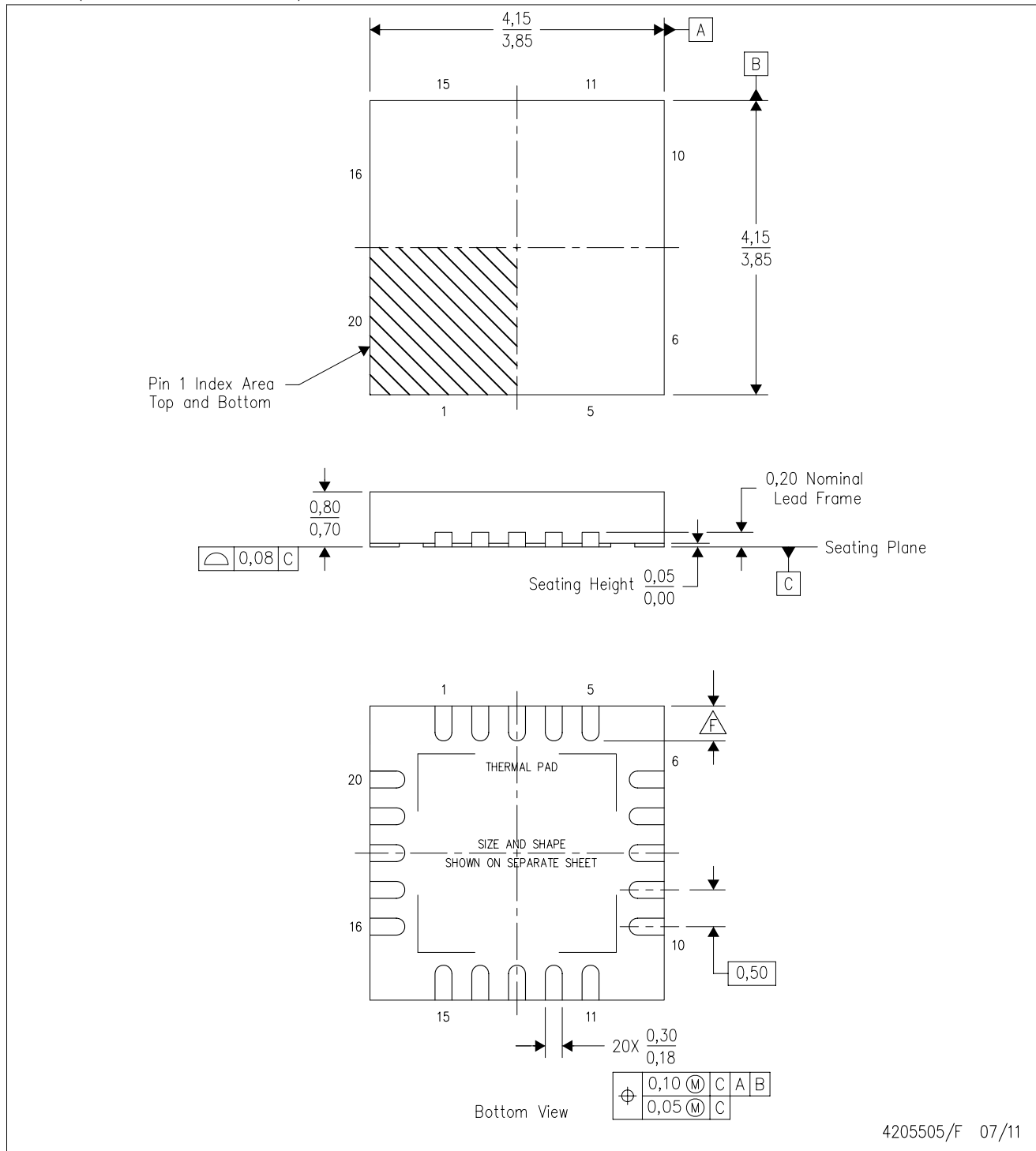
PLASTIC QUAD FLATPACK NO-LEAD



- NOTES:
- All linear dimensions are in millimeters. Dimensioning and tolerancing per ASME Y14.5-1994.
  - This drawing is subject to change without notice.
  - QFN (Quad Flatpack No-Lead) package configuration.
  - The package thermal pad must be soldered to the board for thermal and mechanical performance.
  - See the additional figure in the Product Data Sheet for details regarding the exposed thermal pad features and dimensions.
  - Check thermal pad mechanical drawing in the product datasheet for nominal lead length dimensions.

RTJ (S-PWQFN-N20)

PLASTIC QUAD FLATPACK NO-LEAD

**THERMAL INFORMATION**

This package incorporates an exposed thermal pad that is designed to be attached directly to an external heatsink. The thermal pad must be soldered directly to the printed circuit board (PCB). After soldering, the PCB can be used as a heatsink. In addition, through the use of thermal vias, the thermal pad can be attached directly to the appropriate copper plane shown in the electrical schematic for the device, or alternatively, can be attached to a special heatsink structure designed into the PCB. This design optimizes the heat transfer from the integrated circuit (IC).

For information on the Quad Flatpack No-Lead (QFN) package and its advantages, refer to Application Report, QFN/SON PCB Attachment, Texas Instruments Literature No. SLUA271. This document is available at [www.ti.com](http://www.ti.com).

The exposed thermal pad dimensions for this package are shown in the following illustration.

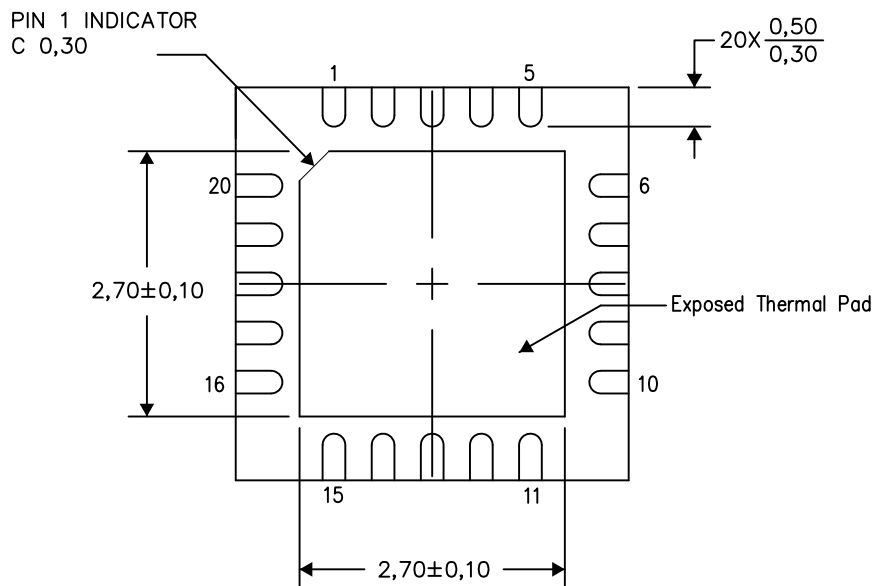

Bottom View

Exposed Thermal Pad Dimensions

4206256-2/V 05/15

NOTE: All linear dimensions are in millimeters

RTJ (S-PWQFN-N20)

PLASTIC QUAD FLATPACK NO-LEAD

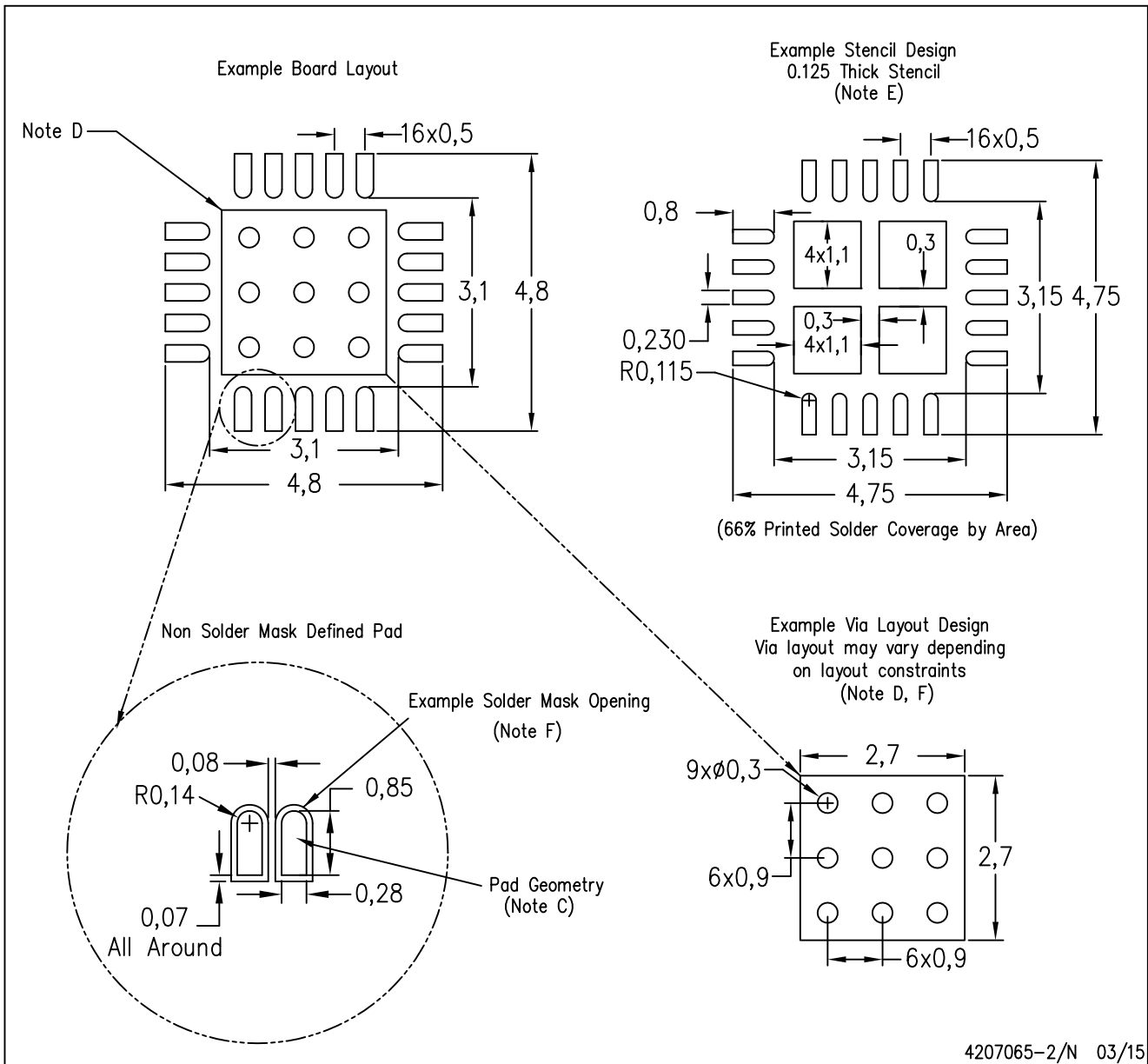

- NOTES:
- All linear dimensions are in millimeters.
  - This drawing is subject to change without notice.
  - Publication IPC-7351 is recommended for alternate designs.
  - This package is designed to be soldered to a thermal pad on the board. Refer to Application Note, Quad Flat-Pack Packages, Texas Instruments Literature No. SLUA271, and also the Product Data Sheets for specific thermal information, via requirements, and recommended board layout. These documents are available at [www.ti.com](http://www.ti.com) <<http://www.ti.com>>.
  - Laser cutting apertures with trapezoidal walls and also rounding corners will offer better paste release. Customers should contact their board assembly site for stencil design recommendations. Refer to IPC 7525 for stencil design considerations.
  - Customers should contact their board fabrication site for recommended solder mask tolerances and via tenting recommendations for vias placed in the thermal pad.

## IMPORTANT NOTICE

Texas Instruments Incorporated and its subsidiaries (TI) reserve the right to make corrections, enhancements, improvements and other changes to its semiconductor products and services per JESD46, latest issue, and to discontinue any product or service per JESD48, latest issue. Buyers should obtain the latest relevant information before placing orders and should verify that such information is current and complete. All semiconductor products (also referred to herein as "components") are sold subject to TI's terms and conditions of sale supplied at the time of order acknowledgment.

TI warrants performance of its components to the specifications applicable at the time of sale, in accordance with the warranty in TI's terms and conditions of sale of semiconductor products. Testing and other quality control techniques are used to the extent TI deems necessary to support this warranty. Except where mandated by applicable law, testing of all parameters of each component is not necessarily performed.

TI assumes no liability for applications assistance or the design of Buyers' products. Buyers are responsible for their products and applications using TI components. To minimize the risks associated with Buyers' products and applications, Buyers should provide adequate design and operating safeguards.

TI does not warrant or represent that any license, either express or implied, is granted under any patent right, copyright, mask work right, or other intellectual property right relating to any combination, machine, or process in which TI components or services are used. Information published by TI regarding third-party products or services does not constitute a license to use such products or services or a warranty or endorsement thereof. Use of such information may require a license from a third party under the patents or other intellectual property of the third party, or a license from TI under the patents or other intellectual property of TI.

Reproduction of significant portions of TI information in TI data books or data sheets is permissible only if reproduction is without alteration and is accompanied by all associated warranties, conditions, limitations, and notices. TI is not responsible or liable for such altered documentation. Information of third parties may be subject to additional restrictions.

Resale of TI components or services with statements different from or beyond the parameters stated by TI for that component or service voids all express and any implied warranties for the associated TI component or service and is an unfair and deceptive business practice. TI is not responsible or liable for any such statements.

Buyer acknowledges and agrees that it is solely responsible for compliance with all legal, regulatory and safety-related requirements concerning its products, and any use of TI components in its applications, notwithstanding any applications-related information or support that may be provided by TI. Buyer represents and agrees that it has all the necessary expertise to create and implement safeguards which anticipate dangerous consequences of failures, monitor failures and their consequences, lessen the likelihood of failures that might cause harm and take appropriate remedial actions. Buyer will fully indemnify TI and its representatives against any damages arising out of the use of any TI components in safety-critical applications.

In some cases, TI components may be promoted specifically to facilitate safety-related applications. With such components, TI's goal is to help enable customers to design and create their own end-product solutions that meet applicable functional safety standards and requirements. Nonetheless, such components are subject to these terms.

No TI components are authorized for use in FDA Class III (or similar life-critical medical equipment) unless authorized officers of the parties have executed a special agreement specifically governing such use.

Only those TI components which TI has specifically designated as military grade or "enhanced plastic" are designed and intended for use in military/aerospace applications or environments. Buyer acknowledges and agrees that any military or aerospace use of TI components which have **not** been so designated is solely at the Buyer's risk, and that Buyer is solely responsible for compliance with all legal and regulatory requirements in connection with such use.

TI has specifically designated certain components as meeting ISO/TS16949 requirements, mainly for automotive use. In any case of use of non-designated products, TI will not be responsible for any failure to meet ISO/TS16949.

### Products

Audio	<a href="http://www.ti.com/audio">www.ti.com/audio</a>
Amplifiers	<a href="http://amplifier.ti.com">amplifier.ti.com</a>
Data Converters	<a href="http://dataconverter.ti.com">dataconverter.ti.com</a>
DLP® Products	<a href="http://www.dlp.com">www.dlp.com</a>
DSP	<a href="http://dsp.ti.com">dsp.ti.com</a>
Clocks and Timers	<a href="http://www.ti.com/clocks">www.ti.com/clocks</a>
Interface	<a href="http://interface.ti.com">interface.ti.com</a>
Logic	<a href="http://logic.ti.com">logic.ti.com</a>
Power Mgmt	<a href="http://power.ti.com">power.ti.com</a>
Microcontrollers	<a href="http://microcontroller.ti.com">microcontroller.ti.com</a>
RFID	<a href="http://www.ti-rfid.com">www.ti-rfid.com</a>
OMAP Applications Processors	<a href="http://www.ti.com/omap">www.ti.com/omap</a>
Wireless Connectivity	<a href="http://www.ti.com/wirelessconnectivity">www.ti.com/wirelessconnectivity</a>

### Applications

Automotive and Transportation	<a href="http://www.ti.com/automotive">www.ti.com/automotive</a>
Communications and Telecom	<a href="http://www.ti.com/communications">www.ti.com/communications</a>
Computers and Peripherals	<a href="http://www.ti.com/computers">www.ti.com/computers</a>
Consumer Electronics	<a href="http://www.ti.com/consumer-apps">www.ti.com/consumer-apps</a>
Energy and Lighting	<a href="http://www.ti.com/energy">www.ti.com/energy</a>
Industrial	<a href="http://www.ti.com/industrial">www.ti.com/industrial</a>
Medical	<a href="http://www.ti.com/medical">www.ti.com/medical</a>
Security	<a href="http://www.ti.com/security">www.ti.com/security</a>
Space, Avionics and Defense	<a href="http://www.ti.com/space-avionics-defense">www.ti.com/space-avionics-defense</a>
Video and Imaging	<a href="http://www.ti.com/video">www.ti.com/video</a>

### TI E2E Community

[e2e.ti.com](http://e2e.ti.com)