

TPS22965x 5.7-V, 6-A, 16-mΩ On-Resistance Load Switch

1 Features

- Integrated Single Channel Load Switch
- Input Voltage Range: 0.8 V to 5.7 V
- Ultra-Low On Resistance (R_{ON})
 - $R_{ON} = 16\text{ m}\Omega$ at $V_{IN} = 5\text{ V}$ ($V_{BIAS} = 5\text{ V}$)
 - $R_{ON} = 16\text{ m}\Omega$ at $V_{IN} = 3.6\text{ V}$ ($V_{BIAS} = 5\text{ V}$)
 - $R_{ON} = 16\text{ m}\Omega$ at $V_{IN} = 1.8\text{ V}$ ($V_{BIAS} = 5\text{ V}$)
- 6-A Maximum Continuous Switch Current
- Low Quiescent Current (50 μA)
- Low Control Input Threshold Enables Use of 1.2-V, 1.8-V, 2.5-V, and 3.3-V Logic
- Configurable Rise Time
- Quick Output Discharge (QOD) (TPS22965 Only)
- SON 8-pin Package With Thermal Pad
- ESD Performance Tested per JESD 22
 - 2000-V HBM and 1000-V CDM

2 Applications

- Ultrabook™
- Notebooks/Netbooks
- Tablet PC
- Consumer Electronics
- Set-top Boxes/Residential Gateways
- Telecom Systems
- Solid State Drives (SSDs)

4 Simplified Schematic

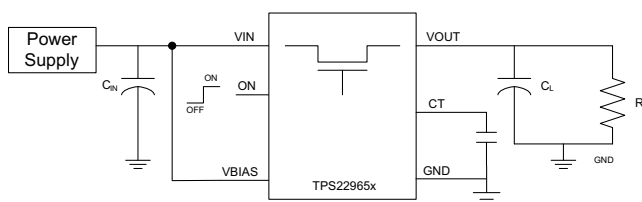

3 Description

The TPS22965x is a single channel load switch that provides configurable rise time to minimize inrush current. The device contains an N-channel MOSFET that can operate over an input voltage range of 0.8 V to 5.7 V and can support a maximum continuous current of 6 A. The switch is controlled by an on/off input (ON), which is capable of interfacing directly with low-voltage control signals. In the TPS22965, a 225- Ω on-chip load resistor is added for quick output discharge when switch is turned off.

The TPS22965x is available in a small, space-saving 2.00 mm \times 2.00 mm 8-pin SON package (DSG) with integrated thermal pad allowing for high power dissipation. The device is characterized for operation over the free-air temperature range of -40°C to 105°C .

Device Information⁽¹⁾

| PART NUMBER | PACKAGE | BODY SIZE (NOM) |
|-------------|----------|--------------------------|
| TPS22965x | WSON (8) | 2.00 mm \times 2.00 mm |

(1) For all available packages, see the orderable addendum at the end of the data sheet.

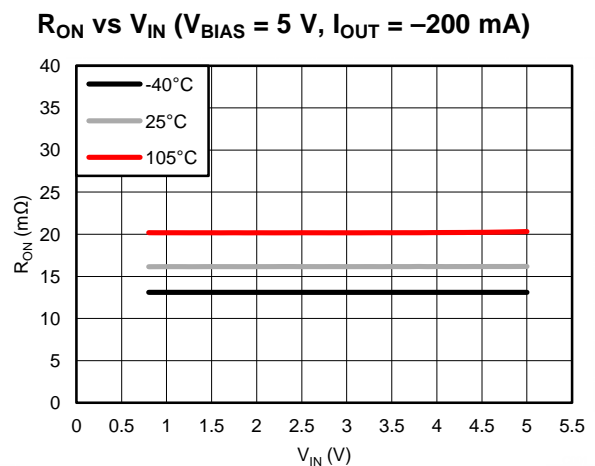

Table of Contents

| | | | |
|---|-----------|--|-----------|
| 1 Features | 1 | 9.1 Overview | 14 |
| 2 Applications | 1 | 9.2 Functional Block Diagram | 14 |
| 3 Description | 1 | 9.3 Feature Description | 15 |
| 4 Simplified Schematic | 1 | 9.4 Device Functional Modes | 15 |
| 5 Revision History | 2 | 10 Application and Implementation | 16 |
| 6 Device Comparison Table | 3 | 10.1 Application Information | 16 |
| 7 Pin Configuration and Functions | 3 | 10.2 Typical Application | 17 |
| 8 Specifications | 4 | 11 Power Supply Recommendations | 18 |
| 8.1 Absolute Maximum Ratings | 4 | 12 Layout | 19 |
| 8.2 ESD Ratings | 4 | 12.1 Layout Guidelines | 19 |
| 8.3 Recommended Operating Conditions | 4 | 12.2 Layout Example | 19 |
| 8.4 Thermal Information | 5 | 12.3 Thermal Considerations | 19 |
| 8.5 Electrical Characteristics, $V_{BIAS} = 5.0\text{ V}$ | 5 | 13 Device and Documentation Support | 20 |
| 8.6 Electrical Characteristics, $V_{BIAS} = 2.5\text{ V}$ | 6 | 13.1 Community Resources | 20 |
| 8.7 Switching Characteristics | 7 | 13.2 Trademarks | 20 |
| 8.8 Typical DC Characteristics | 8 | 13.3 Electrostatic Discharge Caution | 20 |
| 8.9 Typical Switching Characteristics | 11 | 13.4 Glossary | 20 |
| 9 Detailed Description | 14 | 14 Mechanical, Packaging, and Orderable Information | 20 |

5 Revision History

Changes from Revision C (February 2015) to Revision D

Page

| | |
|--|----|
| • Added TPS22965N part number | 1 |
| • Updated Thermal Information table | 5 |
| • Updated typical AC timing parameters (tables, graphs and scope captures) | 11 |

Changes from Revision B (June 2014) to Revision C

Page

| | |
|---|---|
| • Extended Recommended Operating free-air temperature range maximum to 105°C. | 1 |
| • Added temperature operations to <i>Electrical Characteristics</i> , $V_{BIAS} = 5.0\text{ V}$ | 5 |
| • Added temperature operations to <i>Electrical Characteristics</i> , $V_{BIAS} = 2.5\text{ V}$ | 6 |

Changes from Revision A (August 2013) to Revision B

Page

| | |
|---|---|
| • Added <i>Device Information</i> table, <i>ESD Ratings</i> table, <i>Feature Description</i> section, <i>Device Functional Modes</i> , <i>Application and Implementation</i> section, <i>Power Supply Recommendations</i> section, <i>Layout</i> section, <i>Device and Documentation Support</i> section, and <i>Mechanical, Packaging, and Orderable Information</i> section | 1 |
| • Changed MAX value of " V_{IN} " from 5.5 V to 5.7 V. | 4 |
| • Changed MAX value of " V_{BIAS} " from 5.5 V to 5.7 V. | 4 |
| • Changed MAX value of " V_{ON} " from 5.5 V to 5.7 V. | 4 |
| • Added <i>Thermal Information</i> table | 5 |

Changes from Original (August 2012) to Revision A

Page

| | |
|---|---|
| • Updated VON MAX value to fix typo that restricted operating range. Changed MAX value from "VIN" to "5.5" to align with rest of document. | 4 |
|---|---|

6 Device Comparison Table

| DEVICE | R _{ON} AT 3.3 V (TYP) | QUICK OUTPUT DISCHARGE | MAXIMUM OUTPUT CURRENT | ENABLE |
|-----------|--------------------------------|------------------------|------------------------|-------------|
| TPS22965 | 16 mΩ | Yes | 6 A | Active high |
| TPS22965N | 16 mΩ | No | 6 A | Active high |

7 Pin Configuration and Functions

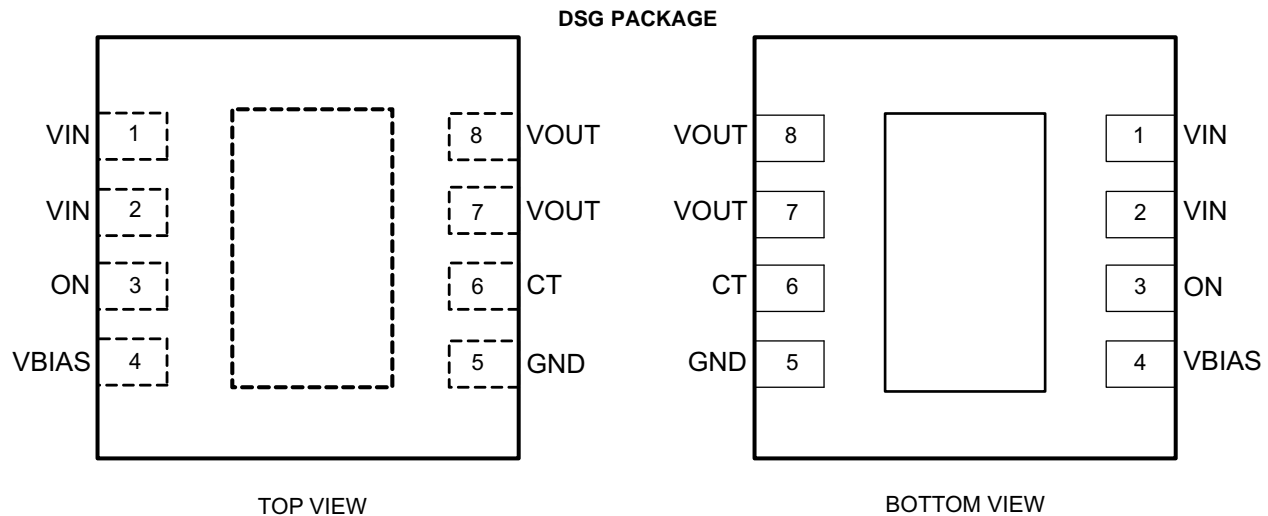

Pin Functions

| PIN | | I/O | DESCRIPTION |
|-------------|------|-----|---|
| NAME | NO. | | |
| VIN | 1, 2 | I | Switch input. Input bypass capacitor recommended for minimizing V _{IN} dip. Must be connected to Pin 1 and Pin 2. See Application and Implementation for more information. |
| ON | 3 | I | Active high switch control input. Do not leave floating. |
| VBIAS | 4 | I | Bias voltage. Power supply to the device. Recommended voltage range for this pin is 2.5 V to 5.7 V. See Application and Implementation for more information. |
| GND | 5 | — | Device ground. |
| CT | 6 | O | Switch slew rate control. Can be left floating. See Adjustable Rise Time for more information. |
| VOUT | 7, 8 | O | Switch output |
| Thermal Pad | — | — | Thermal pad (exposed center pad) to alleviate thermal stress. Tie to GND. See Layout Example for layout guidelines. |

8 Specifications

8.1 Absolute Maximum Ratings

over operating free-air temperature range (unless otherwise noted)^{(1) (2)}

| | | MIN | MAX | UNIT |
|-------------------|--|------|-----|------|
| V _{IN} | Input voltage | -0.3 | 6 | V |
| V _{OUT} | Output voltage | -0.3 | 6 | V |
| V _{BIAS} | Bias voltage | -0.3 | 6 | V |
| V _{ON} | On voltage | -0.3 | 6 | V |
| I _{MAX} | Maximum continuous switch current | | 6 | A |
| I _{PLS} | Maximum pulsed switch current, pulse < 300 μs, 2% duty cycle | | 8 | A |
| T _J | Maximum junction temperature | | 125 | °C |
| T _{stg} | Storage temperature | -65 | 150 | °C |

- (1) Stresses beyond those listed under [Absolute Maximum Ratings](#) may cause permanent damage to the device. These are stress ratings only, and functional operation of the device at these or any other conditions beyond those indicated under [Recommended Operating Conditions](#) are not implied. Exposure to absolute-maximum-rated conditions for extended periods may affect device reliability.
- (2) All voltage values are with respect to network ground pin.

8.2 ESD Ratings

| | | VALUE | UNIT |
|--------------------|-------------------------|--|-------|
| V _(ESD) | Electrostatic discharge | Human-body model (HBM), per ANSI/ESDA/JEDEC JS-001 ⁽¹⁾ | ±2000 |
| | | Charged-device model (CDM), per JEDEC specification JESD22-C101 ⁽²⁾ | ±1000 |

- (1) JEDEC document JEP155 states that 500-V HBM allows safe manufacturing with a standard ESD control process. Manufacturing with less than 500-V HBM is possible with the necessary precautions.
- (2) JEDEC document JEP157 states that 250-V CDM allows safe manufacturing with a standard ESD control process. Manufacturing with less than 250-V CDM is possible with the necessary precautions.

8.3 Recommended Operating Conditions

| | | MIN | MAX | UNIT |
|-------------------|---|------------------------------------|-------------------|------|
| V _{IN} | Input voltage range | 0.8 | V _{BIAS} | V |
| V _{BIAS} | Bias voltage range | 2.5 | 5.7 | V |
| V _{ON} | ON voltage range | 0 | 5.7 | V |
| V _{OUT} | Output voltage range | | V _{IN} | V |
| V _{IH} | High-level input voltage, ON | V _{BIAS} = 2.5 V to 5.7 V | | V |
| V _{IL} | Low-level input voltage, ON | V _{BIAS} = 2.5 V to 5.7 V | | V |
| C _{IN} | Input capacitor | 1 ⁽¹⁾ | | μF |
| T _A | Operating free-air temperature range ⁽²⁾ | -40 | 105 | °C |

- (1) Refer to [Application Information](#).
- (2) In applications where high power dissipation and/or poor package thermal resistance is present, the maximum ambient temperature may have to be derated. Maximum ambient temperature [T_{A(max)}] is dependent on the maximum operating junction temperature [T_{J(max)}], the maximum power dissipation of the device in the application [P_{D(max)}], and the junction-to-ambient thermal resistance of the part/package in the application (θ_{JA}), as given by the following equation: T_{A(max)} = T_{J(max)} - (θ_{JA} × P_{D(max)})

8.4 Thermal Information

| THERMAL METRIC ⁽¹⁾ | | TPS22965x | |
|-------------------------------|--|------------|------|
| | | DSG (WSON) | |
| | | 8 PINS | |
| Symbol | Description | Value | Unit |
| R _{θJA} | Junction-to-ambient thermal resistance | 72.3 | °C/W |
| R _{θJC(top)} | Junction-to-case (top) thermal resistance | 96.1 | °C/W |
| R _{θJB} | Junction-to-board thermal resistance | 42.1 | °C/W |
| ψ _{JT} | Junction-to-top characterization parameter | 3.3 | °C/W |
| ψ _{JB} | Junction-to-board characterization parameter | 42.5 | °C/W |
| R _{θJC(bot)} | Junction-to-case (bottom) thermal resistance | 13.2 | °C/W |

(1) For more information about traditional and new thermal metrics, see the *Semiconductor and IC Package Thermal Metrics* application report, [SPRA953](#).

8.5 Electrical Characteristics, V_{BIAS} = 5.0 V

Unless otherwise noted, the specification in the following table applies where V_{BIAS} = 5.0 V. Typical values are for T_A = 25 °C.

| PARAMETER | | TEST CONDITIONS | T _A | MIN | TYP | MAX | UNIT |
|------------------------------------|--|---|-------------------------|----------------|-------|-----|------|
| POWER SUPPLIES AND CURRENTS | | | | | | | |
| I _Q V _{BIAS} | V _{BIAS} quiescent current | I _{OUT} = 0 mA, V _{IN} = V _{ON} = V _{BIAS} = 5.0 V | -40°C to 105°C | | 50 | 75 | μA |
| I _{SD} V _{BIAS} | V _{BIAS} shutdown current | V _{ON} = GND, V _{OUT} = 0 V | -40°C to 105°C | | | 2 | μA |
| I _{SD} V _{IN} | V _{IN} off-state supply current | V _{ON} = GND, V _{OUT} = 0 V | V _{IN} = 5.0 V | -40°C to 105°C | 0.005 | 5 | μA |
| | | | V _{IN} = 3.3 V | -40°C to 105°C | 0.002 | 3 | |
| | | | V _{IN} = 1.8 V | -40°C to 105°C | 0.002 | 2 | |
| | | | V _{IN} = 0.8 V | -40°C to 105°C | 0.001 | 1 | |
| I _{ON} | ON pin input leakage current | V _{ON} = 5.5 V | -40°C to 105°C | | | 0.5 | μA |
| RESISTANCE CHARACTERISTICS | | | | | | | |
| R _{ON} | ON-state resistance | I _{OUT} = -200 mA, V _{BIAS} = 5.0 V | V _{IN} = 5.0 V | 25°C | 16 | 21 | mΩ |
| | | | | -40°C to 85°C | | 23 | |
| | | | | -40°C to 105°C | | 25 | |
| | | | V _{IN} = 3.3 V | 25°C | 16 | 21 | mΩ |
| | | | | -40°C to 85°C | | 23 | |
| | | | | -40°C to 105°C | | 25 | |
| | | | V _{IN} = 1.8 V | 25°C | 16 | 21 | mΩ |
| | | | | -40°C to 85°C | | 23 | |
| | | | | -40°C to 105°C | | 25 | |
| | | | V _{IN} = 1.5 V | 25°C | 16 | 21 | mΩ |
| | | | | -40°C to 85°C | | 23 | |
| | | | | -40°C to 105°C | | 25 | |
| V _{IN} = 1.2 V | 25°C | 16 | 21 | mΩ | | | |
| | -40°C to 85°C | | 23 | | | | |
| | -40°C to 105°C | | 25 | | | | |
| V _{IN} = 0.8 V | 25°C | 16 | 21 | mΩ | | | |
| | -40°C to 85°C | | 23 | | | | |
| | -40°C to 105°C | | 25 | | | | |
| R _{PD} ⁽¹⁾ | Output pulldown resistance | V _{IN} = 5.0 V, V _{ON} = 0 V, I _{OUT} = 15 mA | -40°C to 105°C | | 225 | 300 | Ω |

(1) TPS22965 only

8.6 Electrical Characteristics, $V_{BIAS} = 2.5\text{ V}$

Unless otherwise noted, the specification in the following table applies where $V_{BIAS} = 2.5\text{ V}$. Typical values are for $T_A = 25\text{ }^\circ\text{C}$.

| PARAMETER | | TEST CONDITIONS | T_A | MIN | TYP | MAX | UNIT |
|------------------------------------|--|---|--|--|-------|-----|------------------|
| POWER SUPPLIES AND CURRENTS | | | | | | | |
| I_Q | V_{BIAS} quiescent current | $I_{OUT} = 0\text{ mA}$, $V_{IN} = V_{ON} = V_{BIAS} = 2.5\text{ V}$ | -40°C to 105°C | | 20 | 30 | μA |
| I_{SD} | V_{BIAS} shutdown current | $V_{ON} = \text{GND}$, $V_{OUT} = 0\text{ V}$ | -40°C to 105°C | | | 2 | μA |
| I_{SD} | V_{IN} off-state supply current | $V_{ON} = \text{GND}$, $V_{OUT} = 0\text{ V}$ | $V_{IN} = 2.5\text{ V}$ | -40°C to 105°C | 0.005 | 3 | μA |
| | | | $V_{IN} = 1.8\text{ V}$ | -40°C to 105°C | 0.002 | 2 | |
| | | | $V_{IN} = 1.2\text{ V}$ | -40°C to 105°C | 0.002 | 2 | |
| | | | $V_{IN} = 0.8\text{ V}$ | -40°C to 105°C | 0.001 | 1 | |
| I_{ON} | ON pin input leakage current | $V_{ON} = 5.5\text{ V}$ | -40°C to 105°C | | | 0.5 | μA |
| RESISTANCE CHARACTERISTICS | | | | | | | |
| R_{ON} | ON-state resistance | $I_{OUT} = -200\text{ mA}$, $V_{BIAS} = 2.5\text{ V}$ | $V_{IN} = 2.5\text{ V}$ | 25°C | 20 | 24 | $\text{m}\Omega$ |
| | | | | -40°C to 85°C | | 27 | |
| | | | | -40°C to 105°C | | 28 | |
| | | | $V_{IN} = 1.8\text{ V}$ | 25°C | 19 | 23 | $\text{m}\Omega$ |
| | | | | -40°C to 85°C | | 26 | |
| | | | | -40°C to 105°C | | 28 | |
| | | | $V_{IN} = 1.5\text{ V}$ | 25°C | 18 | 23 | $\text{m}\Omega$ |
| | | | | -40°C to 85°C | | 25 | |
| | | | | -40°C to 105°C | | 27 | |
| | | | $V_{IN} = 1.2\text{ V}$ | 25°C | 18 | 23 | $\text{m}\Omega$ |
| | | | | -40°C to 85°C | | 25 | |
| | | | | -40°C to 105°C | | 27 | |
| $V_{IN} = 0.8\text{ V}$ | 25°C | 17 | 22 | $\text{m}\Omega$ | | | |
| | -40°C to 85°C | | 25 | | | | |
| | -40°C to 105°C | | 27 | | | | |
| $R_{PD}^{(1)}$ | Output pulldown resistance | $V_{IN} = 2.5\text{ V}$, $V_{ON} = 0\text{ V}$, $I_{OUT} = 1\text{ mA}$ | -40°C to 105°C | | 275 | 325 | Ω |

(1) TPS22965 only

8.7 Switching Characteristics

| PARAMETER | TEST CONDITION | MIN | TYP | MAX | UNIT |
|---|---|-----|------|-----|---------------|
| $V_{IN} = V_{ON} = V_{BIAS} = 5\text{ V}$, $T_A = 25^\circ\text{C}$ (unless otherwise noted) | | | | | |
| t_{ON} Turn-on time | $R_L = 10\ \Omega$, $C_L = 0.1\ \mu\text{F}$, $C_T = 1000\ \text{pF}$ | | 1600 | | μs |
| t_{OFF} Turn-off time | | | 9 | | |
| t_R V_{OUT} rise time | | | 1985 | | |
| t_F V_{OUT} fall time | | | 3 | | |
| t_D ON delay time | | | 660 | | |
| $V_{IN} = 0.8\text{ V}$, $V_{ON} = V_{BIAS} = 5\text{ V}$, $T_A = 25^\circ\text{C}$ (unless otherwise noted) | | | | | |
| t_{ON} Turn-on time | $R_L = 10\ \Omega$, $C_L = 0.1\ \mu\text{F}$, $C_T = 1000\ \text{pF}$ | | 730 | | μs |
| t_{OFF} Turn-off time | | | 100 | | |
| t_R V_{OUT} rise time | | | 380 | | |
| t_F V_{OUT} fall time | | | 8 | | |
| t_D ON delay time | | | 560 | | |
| $V_{IN} = 2.5\text{ V}$, $V_{ON} = 5\text{ V}$, $V_{BIAS} = 2.5\text{ V}$, $T_A = 25^\circ\text{C}$ (unless otherwise noted) | | | | | |
| t_{ON} Turn-on time | $R_L = 10\ \Omega$, $C_L = 0.1\ \mu\text{F}$, $C_T = 1000\ \text{pF}$ | | 2435 | | μs |
| t_{OFF} Turn-off time | | | 9 | | |
| t_R V_{OUT} rise time | | | 2515 | | |
| t_F V_{OUT} fall time | | | 4 | | |
| t_D ON delay time | | | 1230 | | |
| $V_{IN} = 0.8\text{ V}$, $V_{ON} = 5\text{ V}$, $V_{BIAS} = 2.5\text{ V}$, $T_A = 25^\circ\text{C}$ (unless otherwise noted) | | | | | |
| t_{ON} Turn-on time | $R_L = 10\ \Omega$, $C_L = 0.1\ \mu\text{F}$, $C_T = 1000\ \text{pF}$ | | 1565 | | μs |
| t_{OFF} Turn-off time | | | 70 | | |
| t_R V_{OUT} rise time | | | 930 | | |
| t_F V_{OUT} fall time | | | 8 | | |
| t_D ON delay time | | | 1110 | | |

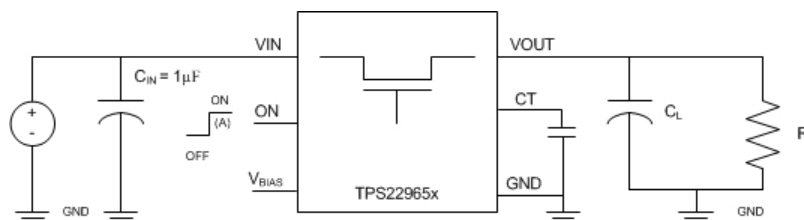

A. Rise and fall times of the control signal is 100 ns.

Figure 1. Test Circuit

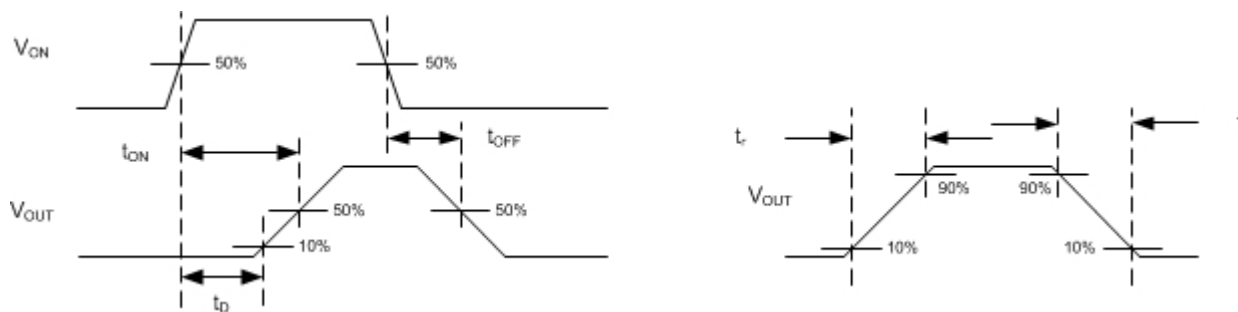
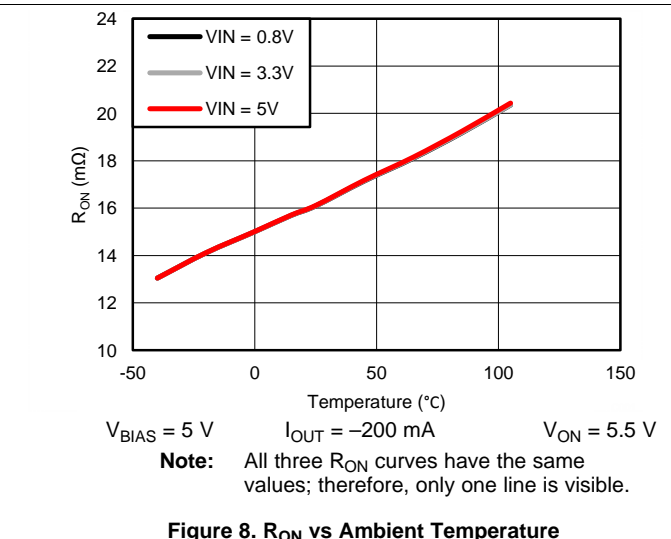
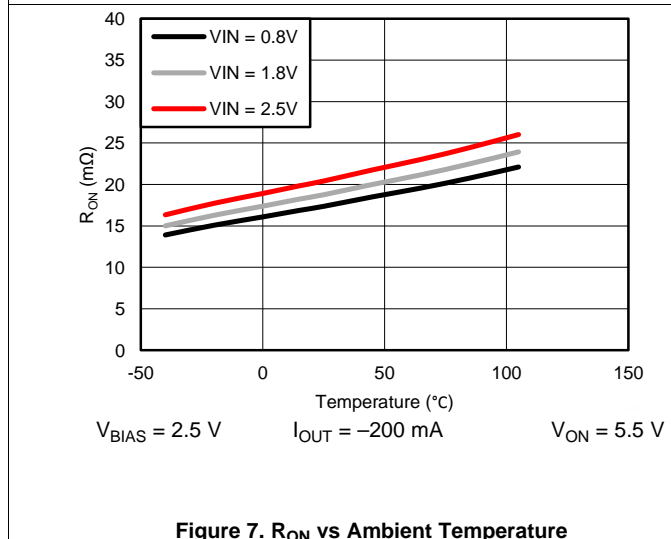
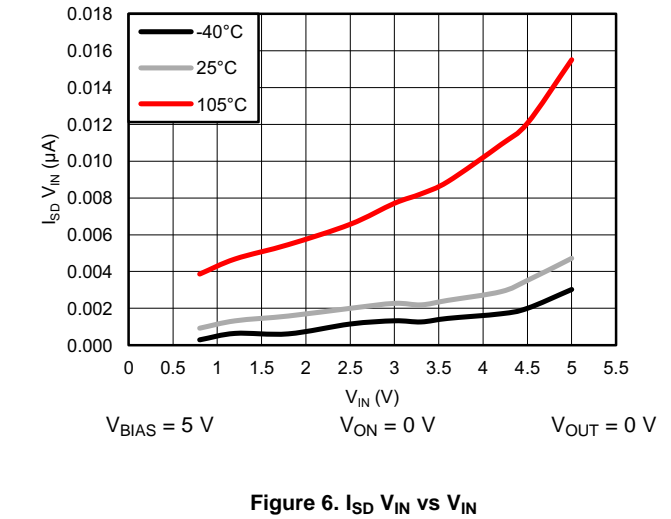
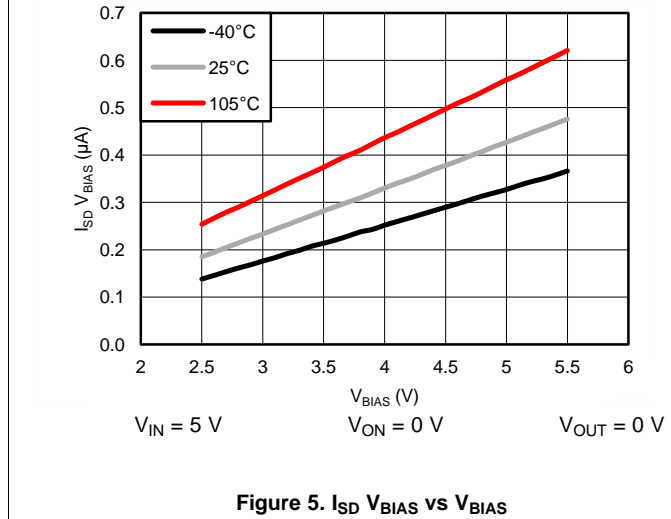
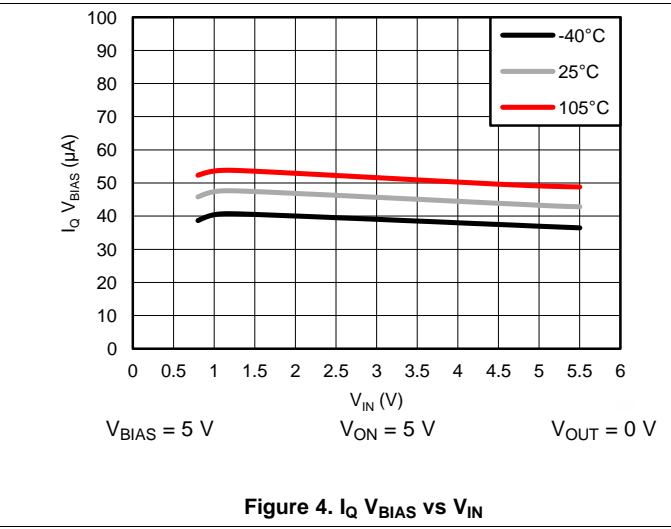
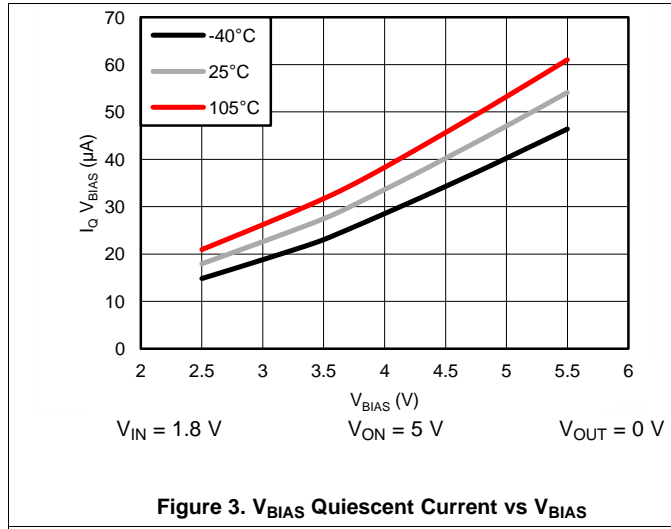
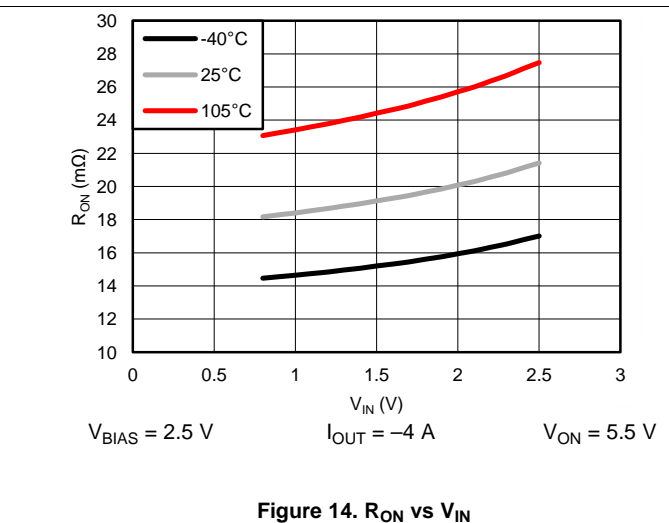
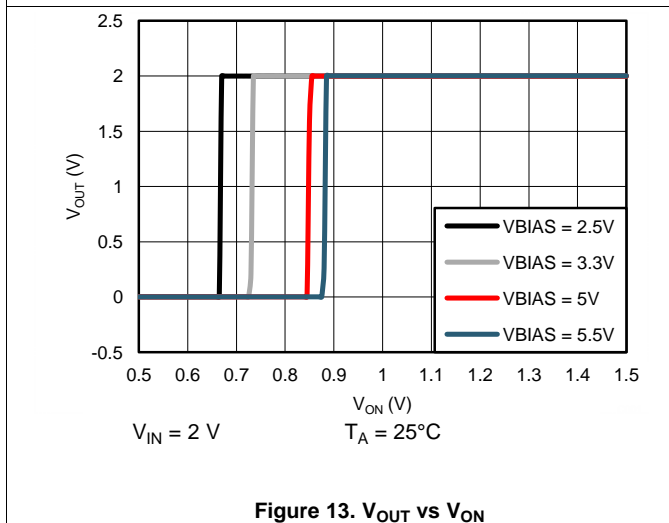
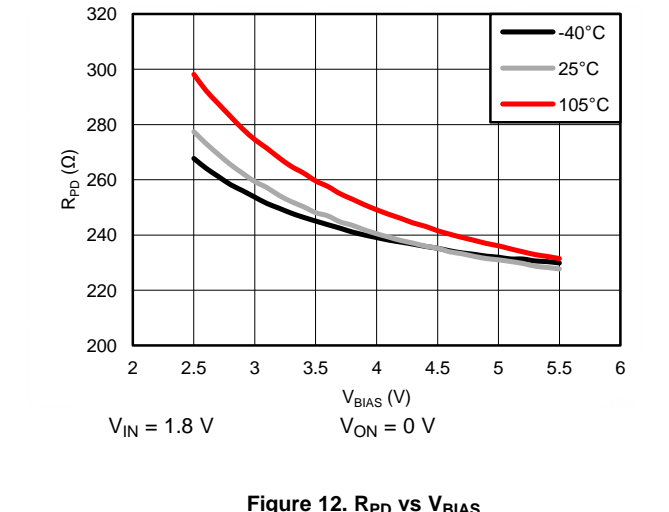
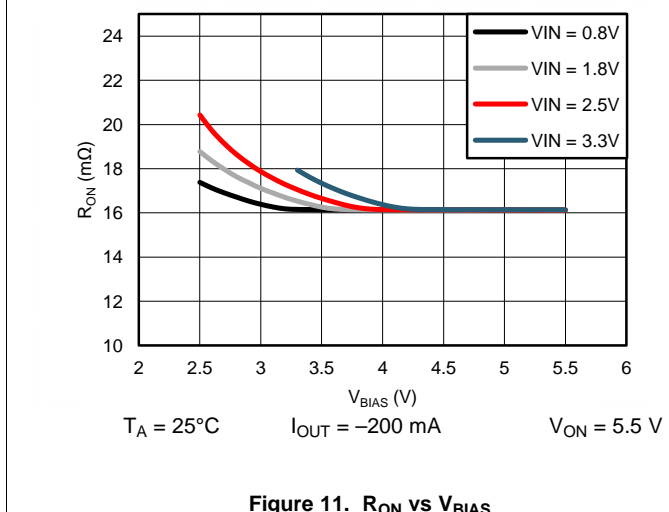
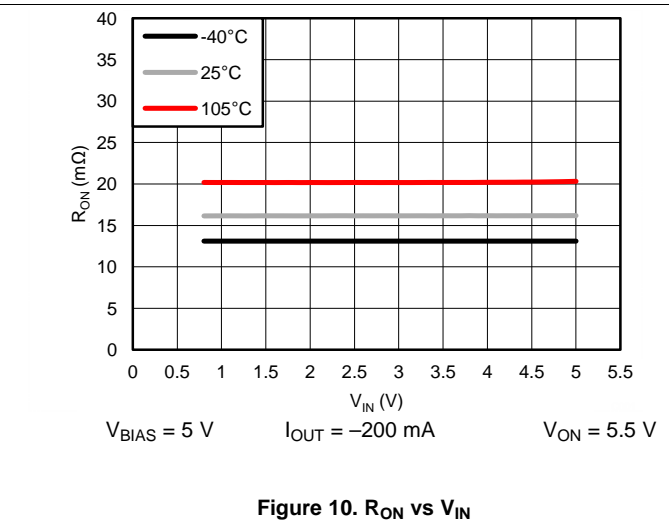
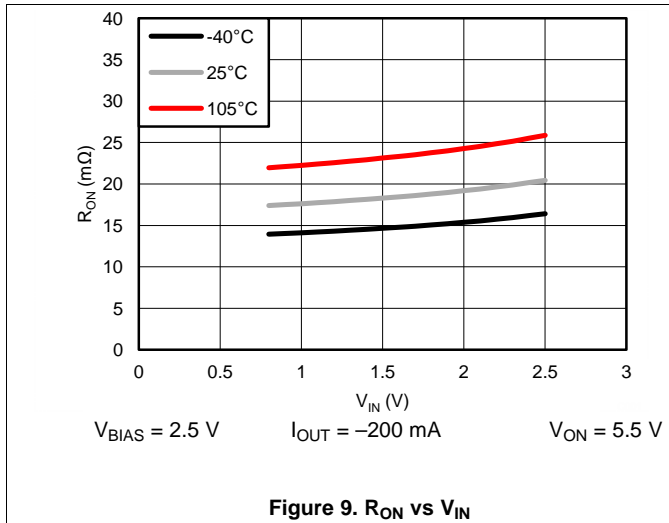

Figure 2. t_{ON}/t_{OFF} Waveforms

8.8 Typical DC Characteristics



Typical DC Characteristics (continued)



Typical DC Characteristics (continued)

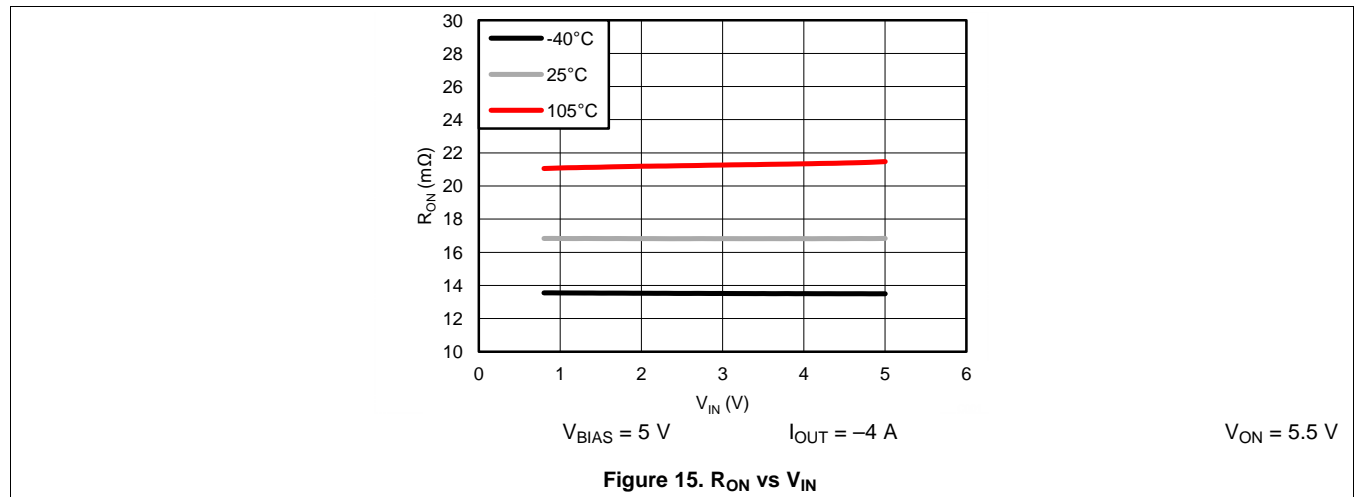

8.9 Typical Switching Characteristics

$T_A = 25^\circ\text{C}$, $C_T = 1000\text{ pF}$, $C_{IN} = 1\text{ }\mu\text{F}$, $C_L = 0.1\text{ }\mu\text{F}$, $R_L = 10\text{ }\Omega$

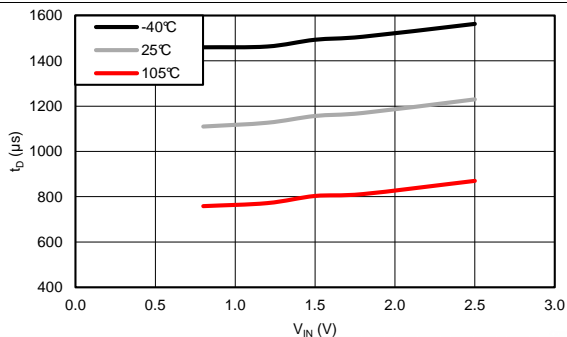

$V_{BIAS} = 2.5\text{ V}$ $C_T = 1000\text{ pF}$

Figure 16. t_D vs V_{IN}

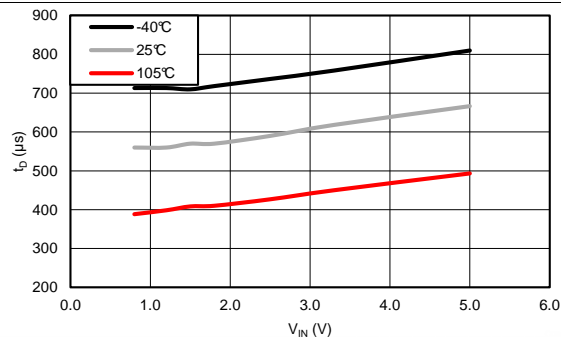

$V_{BIAS} = 5\text{ V}$ $C_T = 1000\text{ pF}$

Figure 17. t_D vs V_{IN}

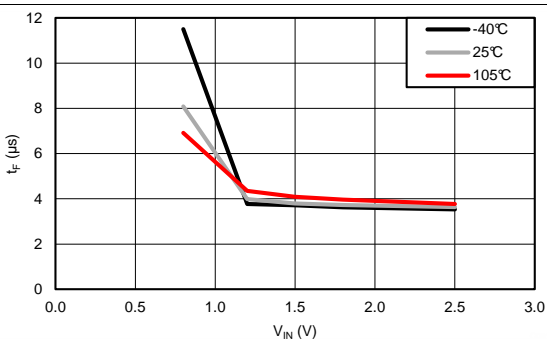

$V_{BIAS} = 2.5\text{ V}$ $C_T = 1000\text{ pF}$

Figure 18. t_r vs V_{IN}

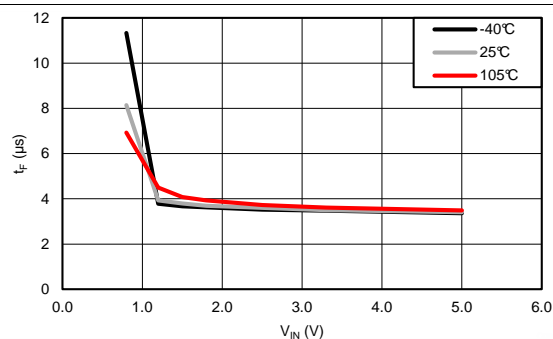

$V_{BIAS} = 5\text{ V}$ $C_T = 1000\text{ pF}$

Figure 19. t_r vs V_{IN}

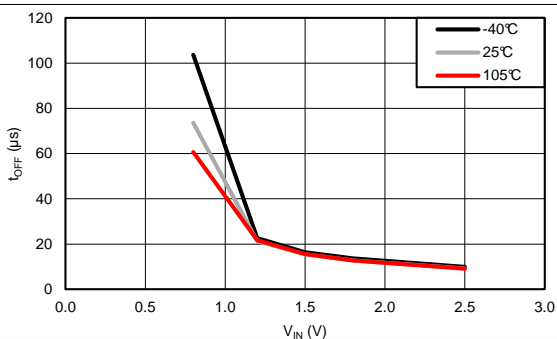

$V_{BIAS} = 2.5\text{ V}$ $C_T = 1000\text{ pF}$

Figure 20. t_{OFF} vs V_{IN}

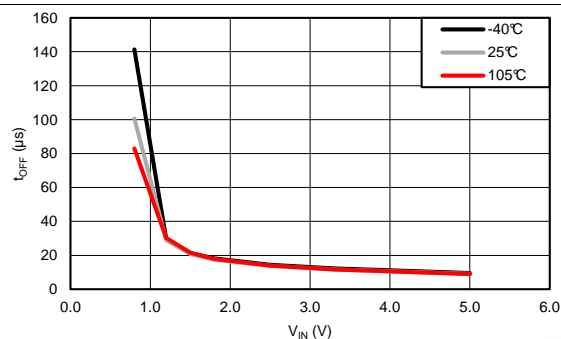

$V_{BIAS} = 5\text{ V}$ $C_T = 1000\text{ pF}$

Figure 21. t_{OFF} vs V_{IN}

Typical Switching Characteristics (continued)

$T_A = 25^\circ\text{C}$, $C_T = 1000\text{ pF}$, $C_{IN} = 1\text{ }\mu\text{F}$, $C_L = 0.1\text{ }\mu\text{F}$, $R_L = 10\text{ }\Omega$

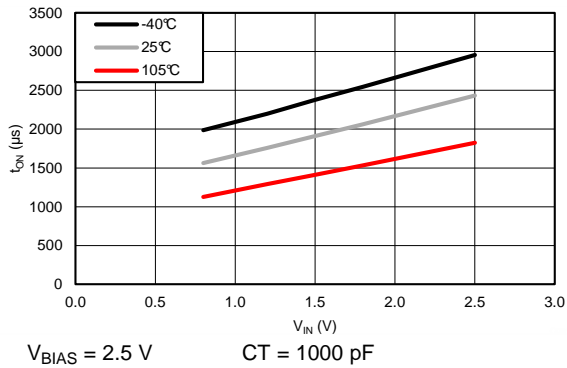

Figure 22. t_{ON} vs V_{IN}

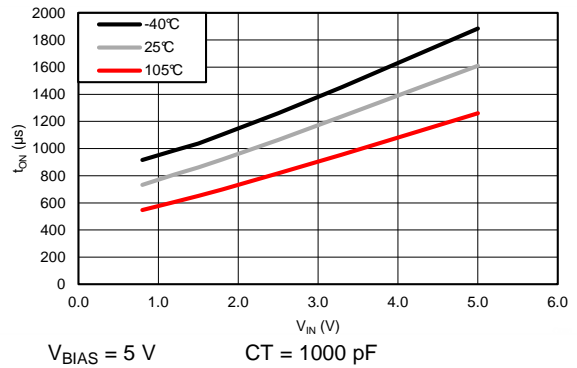

Figure 23. t_{ON} vs V_{IN}

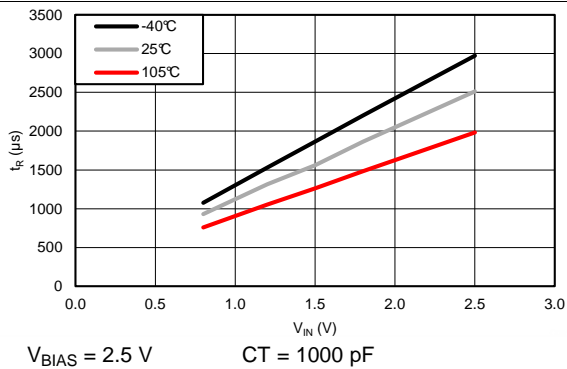

Figure 24. t_R vs V_{IN}

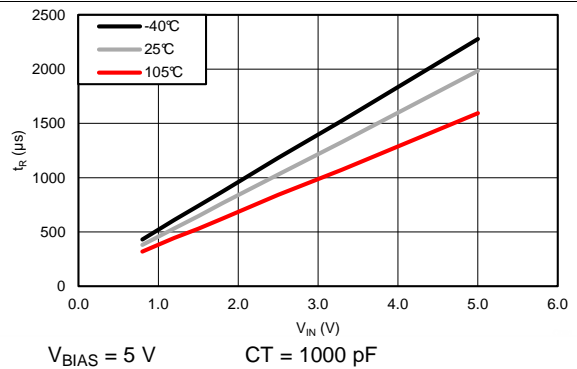

Figure 25. t_R vs V_{IN}

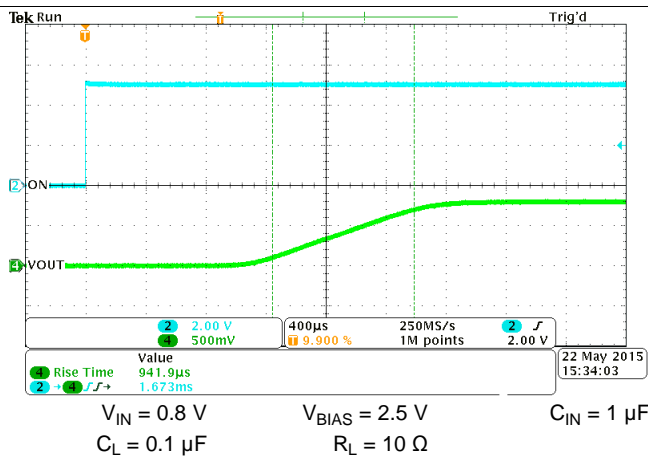

Figure 26. Turn-on Response Time

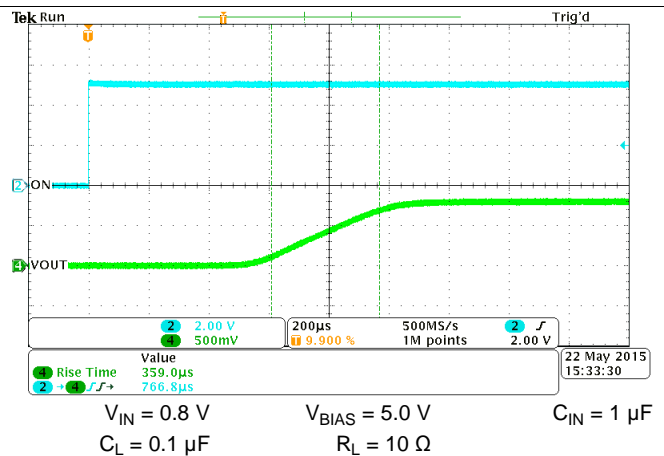

Figure 27. Turn-on Response Time

Typical Switching Characteristics (continued)

$T_A = 25^\circ\text{C}$, $C_T = 1000\text{ pF}$, $C_{IN} = 1\text{ }\mu\text{F}$, $C_L = 0.1\text{ }\mu\text{F}$, $R_L = 10\text{ }\Omega$

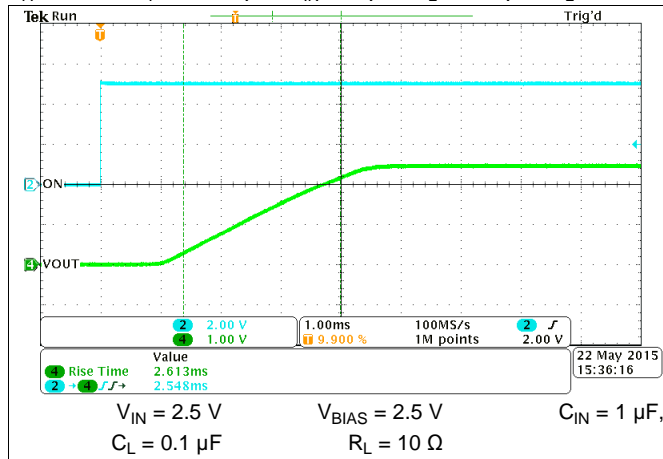

Figure 28. Turn-on Response Time

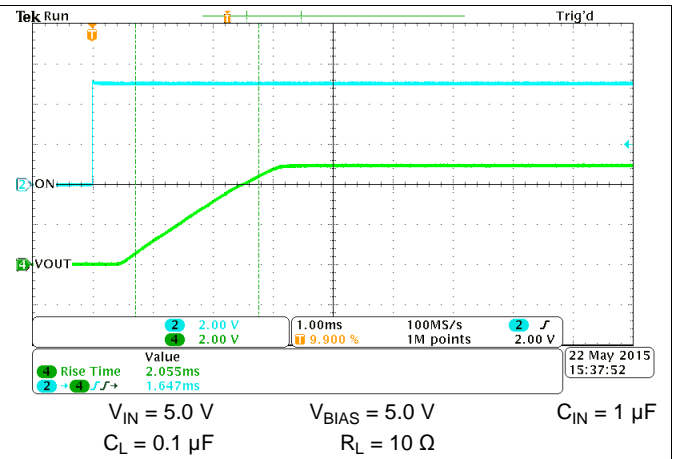

Figure 29. Turn-on Response Time

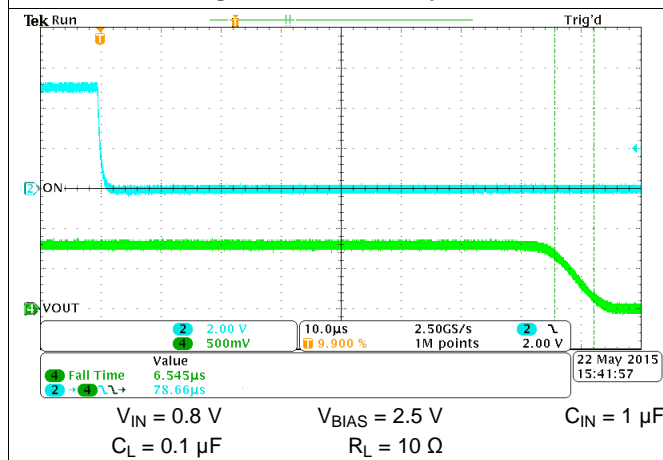

Figure 30. Turn-off Response Time

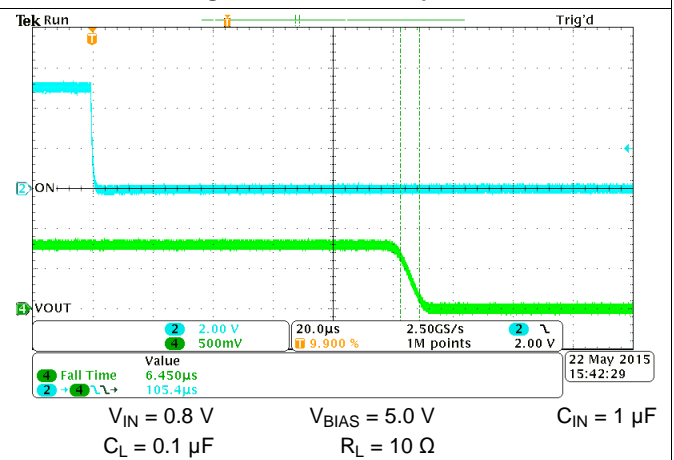

Figure 31. Turn-off Response Time

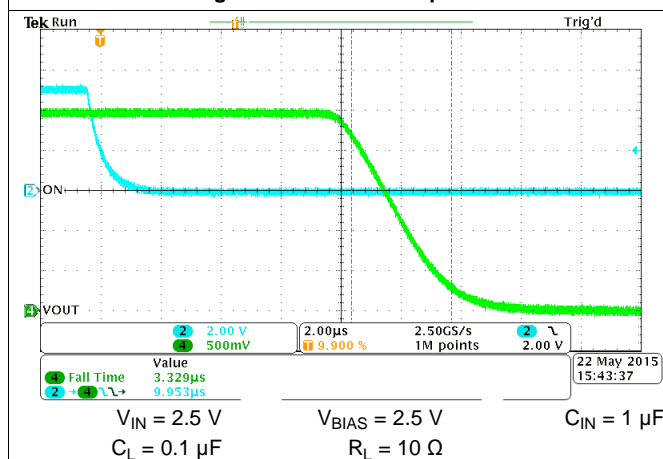

Figure 32. Turn-off Response Time

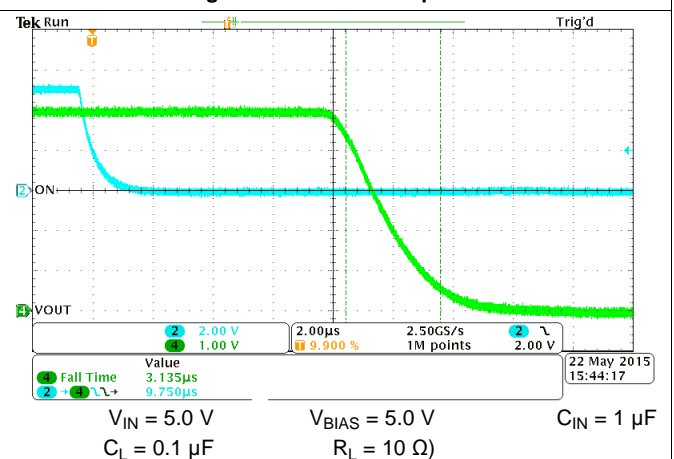

Figure 33. Turn-off Response Time

9 Detailed Description

9.1 Overview

The TPS22965x device is a single channel, 6-A load switch in an 8-pin SON package. To reduce the voltage drop in high current rails, the device implements an ultra-low resistance N-channel MOSFET. The device has a programmable slew rate for applications that require specific rise-time.

The device has very low leakage current during off state. This prevents downstream circuits from pulling high standby current from the supply. Integrated control logic, driver, power supply, and output discharge FET eliminates the need for any external components, which reduces solution size and bill of materials (BOM) count.

9.2 Functional Block Diagram

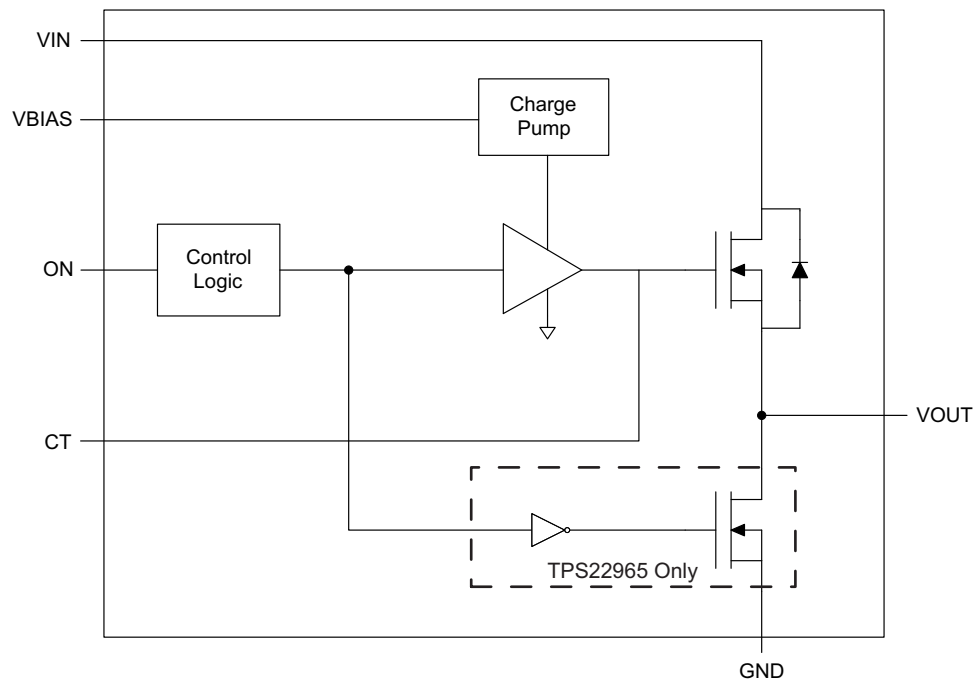

9.3 Feature Description

9.3.1 Adjustable Rise Time

A capacitor to GND on the CT pin sets the slew rate. The voltage on the CT pin can be as high as 12 V; therefore, the minimum voltage rating for the CT capacitor should be 25 V for optimal performance. An approximate formula for the relationship between CT and slew rate when V_{BIAS} is set to 5 V is shown in [Equation 1](#). This equation accounts for 10% to 90% measurement on V_{OUT} and does **NOT** apply for CT = 0 pF. Use [Table 1](#) to determine rise times for when CT = 0 pF.

$$SR = 0.38 \times CT + 34$$

where

- SR = slew rate (in $\mu\text{s}/\text{V}$)
- CT = the capacitance value on the CT pin (in pF)
- The units for the constant 34 are $\mu\text{s}/\text{V}$. The units for the constant 0.38 are $\mu\text{s}/(\text{V} \times \text{pF})$. (1)

Rise time can be calculated by multiplying the input voltage by the slew rate. The table below contains rise time values measured on a typical device. Rise times shown below are only valid for the power-up sequence where V_{IN} and V_{BIAS} are already in steady state condition before the ON pin is asserted high.

Table 1. Rise Time vs CT Capacitor

| CT (pF) | RISE TIME (μs) 10% - 90%, $C_L = 0.1 \mu\text{F}$, $C_{IN} = 1 \mu\text{F}$, $R_L = 10 \Omega$, $V_{BIAS} = 5 \text{V}$ TYPICAL VALUES at 25°C with a 25 V X7R 10% CERAMIC CAPACITOR on CT | | | | | | |
|---------|---|-------------|-------------|-------------|-------------|--------------|-------------|
| | VIN = 5 V | VIN = 3.3 V | VIN = 1.8 V | VIN = 1.5 V | VIN = 1.2 V | VIN = 1.05 V | VIN = 0.8 V |
| 0 | 180 | 136 | 94 | 84 | 74 | 70 | 60 |
| 220 | 547 | 378 | 232 | 202 | 173 | 157 | 129 |
| 470 | 962 | 654 | 386 | 333 | 282 | 252 | 206 |
| 1000 | 1983 | 1330 | 765 | 647 | 533 | 476 | 382 |
| 2200 | 4013 | 2693 | 1537 | 1310 | 1077 | 959 | 766 |
| 4700 | 8207 | 5490 | 3137 | 2693 | 2200 | 1970 | 1590 |
| 10000 | 17700 | 11767 | 6697 | 5683 | 4657 | 4151 | 3350 |

9.3.2 Quick Output Discharge (QOD) (TPS22965 Only)

The TPS22965 includes a QOD feature. When the switch is disabled, a discharge resistor is connected between V_{OUT} and GND. This resistor has a typical value of 225 Ω and prevents the output from floating while the switch is disabled.

9.3.3 Low Power Consumption During Off State

The I_{SD} V_{IN} supply current is 0.01 μA typical at 1.8 V_{IN} . Typically, the downstream loads would have a significantly higher off-state leakage current. The load switch allows system standby power consumption to be reduced.

9.4 Device Functional Modes

The [Table 2](#) lists the V_{OUT} pin states as determined by the ON pin.

Table 2. VOUT Connection

| ON | TPS22965 | TPS22965N |
|----|----------|-----------|
| L | GND | Open |
| H | VIN | VIN |

10 Application and Implementation

NOTE

Information in the following applications sections is not part of the TI component specification, and TI does not warrant its accuracy or completeness. TI's customers are responsible for determining suitability of components for their purposes. Customers should validate and test their design implementation to confirm system functionality.

10.1 Application Information

10.1.1 ON/OFF Control

The ON pin controls the state of the switch. Asserting ON high enables the switch. ON is active high and has a low threshold, making it capable of interfacing with low-voltage signals. The ON pin is compatible with standard GPIO logic thresholds. It can be used with any microcontroller with 1.2 V or higher GPIO voltage. This pin cannot be left floating and must be driven either high or low for proper functionality.

10.1.2 Input Capacitor (Optional)

To limit the voltage drop on the input supply caused by transient inrush currents when the switch turns on into a discharged load capacitor or short-circuit, a capacitor needs to be placed between VIN and GND. A 1- μ F ceramic capacitor, C_{IN}, placed close to the pins, is usually sufficient. Higher values of C_{IN} can be used to further reduce the voltage drop during high current applications. When switching heavy loads, it is recommended to have an input capacitor about 10 times higher than the output capacitor to avoid excessive voltage drop.

10.1.3 Output Capacitor (Optional)

Due to the integrated body diode in the NMOS switch, a C_{IN} greater than C_L is highly recommended. A C_L greater than C_{IN} can cause V_{OUT} to exceed V_{IN} when the system supply is removed. This could result in current flow through the body diode from V_{OUT} to V_{IN}. A C_{IN} to C_L ratio of 10 to 1 is recommended for minimizing V_{IN} dip caused by inrush currents during startup; however, a 10 to 1 ratio for capacitance is not required for proper functionality of the device. A ratio smaller than 10 to 1 (such as 1 to 1) could cause slightly more V_{IN} dip upon turn-on due to inrush currents. This can be mitigated by increasing the capacitance on the CT pin for a longer rise time (see [Adjustable Rise Time](#) section below).

10.1.4 V_{IN} and V_{BIAS} Voltage Range

For optimal R_{ON} performance, make sure V_{IN} \leq V_{BIAS}. The device will still be functional if V_{IN} > V_{BIAS} but it will exhibit R_{ON} greater than what is listed in the [Electrical Characteristics, V_{BIAS} = 5.0 V](#) table. See [Figure 34](#) for an example of a typical device. Notice the increasing R_{ON} as V_{IN} exceeds V_{BIAS} voltage. Never exceed the maximum voltage rating for V_{IN} and V_{BIAS}.

Application Information (continued)

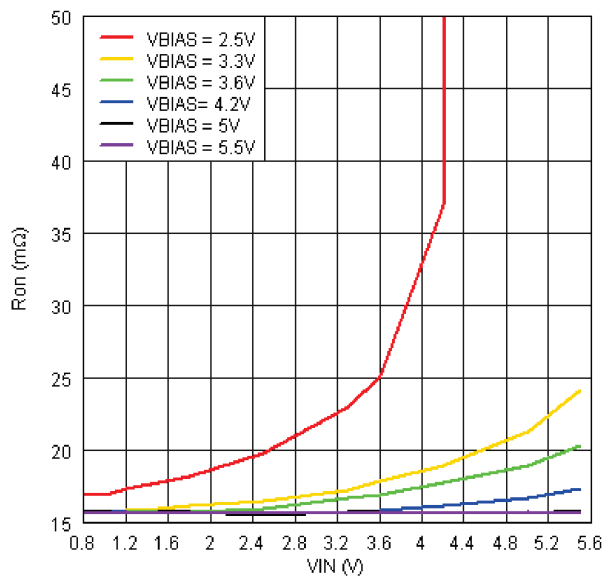

TA = 25 °C IOUT = -200 mA

Figure 34. RON vs VIN

10.2 Typical Application

This application demonstrates how the TPS22965x can be used to power downstream modules.

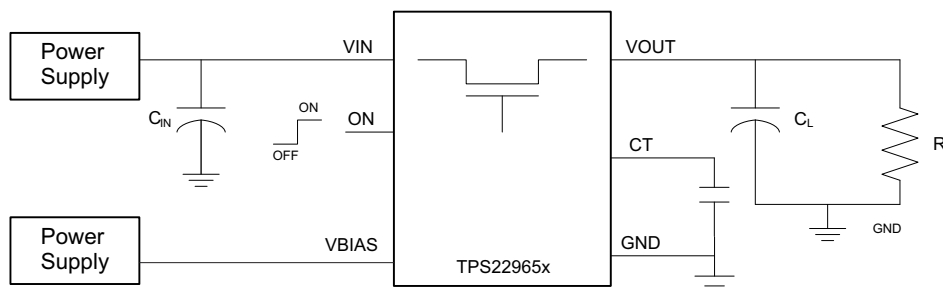

Figure 35. Powering a Downstream Module

10.2.1 Design Requirements

| DESIGN PARAMETER | EXAMPLE VALUE |
|-----------------------------------|---------------|
| VIN | 3.3 V |
| VBIAS | 5 V |
| CL | 22 μF |
| Maximum Acceptable Inrush Current | 400 mA |

10.2.2 Detailed Design Procedure

10.2.2.1 Inrush Current

When the switch is enabled, the output capacitors must be charged up from 0 V to the set value (3.3 V in this example). This charge arrives in the form of inrush current. Inrush current can be calculated using the following equation:

$$\text{Inrush Current} = C \times dV/dt$$

where

- C = output capacitance
- dV = output voltage
- dt = rise time

(2)

The TPS22965x offers adjustable rise time for VOUT. This feature allows the user to control the inrush current during turn-on. The appropriate rise time can be calculated using the design requirements and the inrush current equation.

$$400 \text{ mA} = 22 \text{ } \mu\text{F} \times 3.3 \text{ V}/dt \tag{3}$$

$$dt = 181.5 \text{ } \mu\text{s} \tag{4}$$

To ensure an inrush current of less than 400 mA, choose a CT value that will yield a rise time of more than 181.5 μs . See the oscilloscope captures below ([Application Curves](#)) for an example of how the CT capacitor can be used to reduce inrush current.

10.2.3 Application Curves

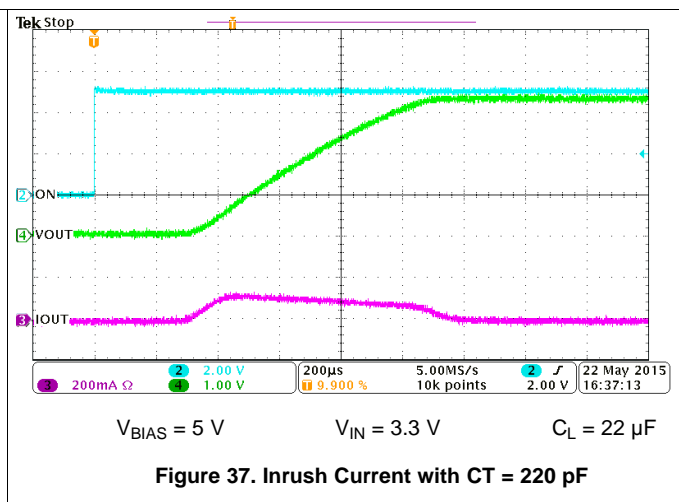
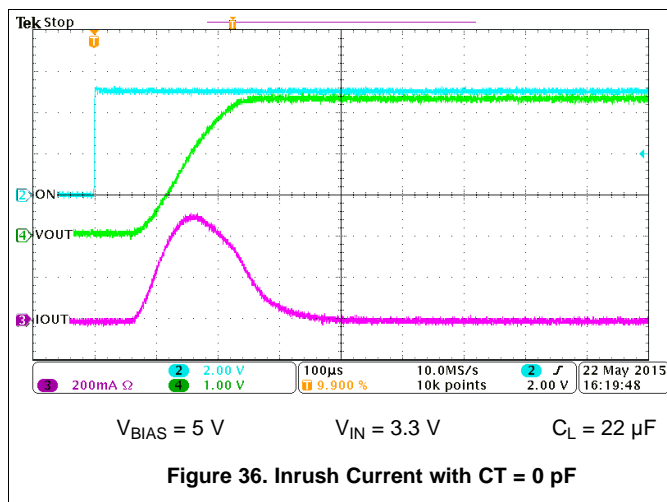

11 Power Supply Recommendations

The device is designed to operate from a VBIAS range of 2.5 V to 5.7 V and a VIN range of 0.8 V to VBIAS.

12 Layout

12.1 Layout Guidelines

For best performance, all traces should be as short as possible. To be most effective, the input and output capacitors should be placed close to the device to minimize the effects that parasitic trace inductances may have on normal operation. Using wide traces for VIN, VOUT, and GND helps minimize the parasitic electrical effects along with minimizing the case to ambient thermal impedance. The CT trace should be as short as possible to avoid parasitic capacitance.

12.2 Layout Example

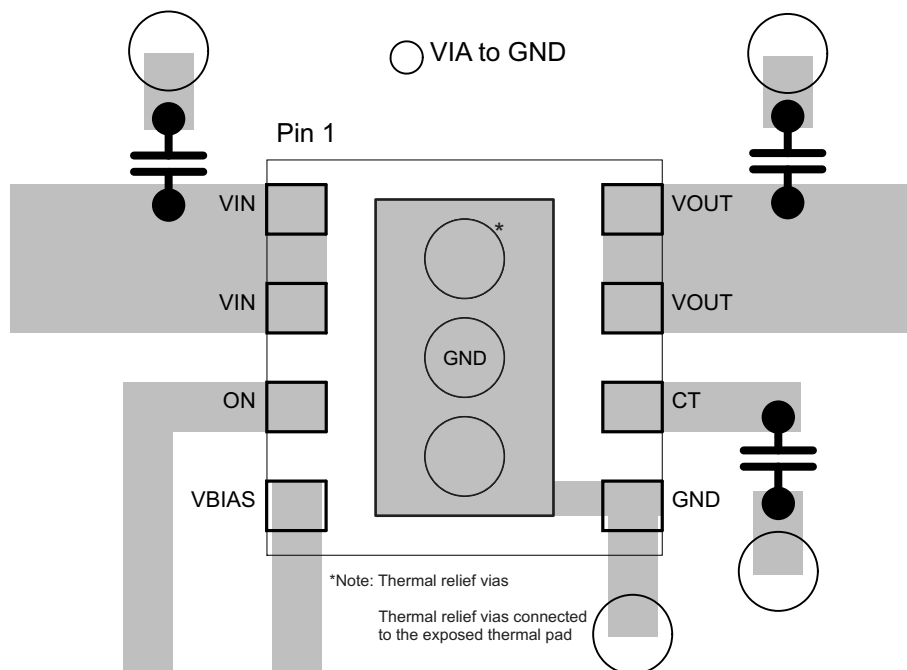

Figure 38. Layout Recommendation

12.3 Thermal Considerations

The maximum IC junction temperature should be restricted to 125°C under normal operating conditions. To calculate the maximum allowable dissipation, $P_{D(max)}$ for a given output current and ambient temperature, use the following equation as a guideline:

$$P_{D(max)} = \frac{T_{J(max)} - T_A}{\theta_{JA}}$$

where

- $P_{D(max)}$ = maximum allowable power dissipation
- $T_{J(max)}$ = maximum allowable junction temperature (125°C for the TPS22965x)
- T_A = ambient temperature of the device
- θ_{JA} = junction to air thermal impedance. See the [Thermal Information](#). This parameter is highly dependent upon board layout. (5)

Refer to [Figure 38](#), notice that the thermal vias are located under the exposed thermal pad of the device. This allows for thermal diffusion away from the device.

13 Device and Documentation Support

13.1 Community Resources

The following links connect to TI community resources. Linked contents are provided "AS IS" by the respective contributors. They do not constitute TI specifications and do not necessarily reflect TI's views; see TI's [Terms of Use](#).

TI E2E™ Online Community *TI's Engineer-to-Engineer (E2E) Community*. Created to foster collaboration among engineers. At e2e.ti.com, you can ask questions, share knowledge, explore ideas and help solve problems with fellow engineers.

Design Support *TI's Design Support* Quickly find helpful E2E forums along with design support tools and contact information for technical support.

13.2 Trademarks

E2E is a trademark of Texas Instruments.

Ultrabook is a trademark of Intel.

All other trademarks are the property of their respective owners.

13.3 Electrostatic Discharge Caution



These devices have limited built-in ESD protection. The leads should be shorted together or the device placed in conductive foam during storage or handling to prevent electrostatic damage to the MOS gates.

13.4 Glossary

[SLYZ022](#) — *TI Glossary*.

This glossary lists and explains terms, acronyms, and definitions.

14 Mechanical, Packaging, and Orderable Information

The following pages include mechanical, packaging, and orderable information. This information is the most current data available for the designated devices. This data is subject to change without notice and revision of this document. For browser-based versions of this data sheet, refer to the left-hand navigation.

PACKAGING INFORMATION

| Orderable Device | Status (1) | Package Type | Package Drawing | Pins | Package Qty | Eco Plan (2) | Lead/Ball Finish (6) | MSL Peak Temp (3) | Op Temp (°C) | Device Marking (4/5) | Samples |
|------------------|---------------|--------------|-----------------|------|-------------|-------------------------|-------------------------|----------------------|--------------|-------------------------|-------------------------|
| TPS22965DSGR | ACTIVE | WSO | DSG | 8 | 3000 | Green (RoHS & no Sb/Br) | CU NIPDAU | Level-2-260C-1 YEAR | -40 to 105 | ZSA0 | Samples |
| TPS22965DSGT | ACTIVE | WSO | DSG | 8 | 250 | Green (RoHS & no Sb/Br) | CU NIPDAU | Level-2-260C-1 YEAR | -40 to 105 | ZSA0 | Samples |
| TPS22965NDSGR | ACTIVE | WSO | DSG | 8 | 3000 | Green (RoHS & no Sb/Br) | CU NIPDAU | Level-2-260C-1 YEAR | -40 to 105 | ZDVI | Samples |

(1) The marketing status values are defined as follows:

ACTIVE: Product device recommended for new designs.

LIFEBUY: TI has announced that the device will be discontinued, and a lifetime-buy period is in effect.

NRND: Not recommended for new designs. Device is in production to support existing customers, but TI does not recommend using this part in a new design.

PREVIEW: Device has been announced but is not in production. Samples may or may not be available.

OBSELETE: TI has discontinued the production of the device.

(2) Eco Plan - The planned eco-friendly classification: Pb-Free (RoHS), Pb-Free (RoHS Exempt), or Green (RoHS & no Sb/Br) - please check <http://www.ti.com/productcontent> for the latest availability information and additional product content details.

TBD: The Pb-Free/Green conversion plan has not been defined.

Pb-Free (RoHS): TI's terms "Lead-Free" or "Pb-Free" mean semiconductor products that are compatible with the current RoHS requirements for all 6 substances, including the requirement that lead not exceed 0.1% by weight in homogeneous materials. Where designed to be soldered at high temperatures, TI Pb-Free products are suitable for use in specified lead-free processes.

Pb-Free (RoHS Exempt): This component has a RoHS exemption for either 1) lead-based flip-chip solder bumps used between the die and package, or 2) lead-based die adhesive used between the die and leadframe. The component is otherwise considered Pb-Free (RoHS compatible) as defined above.

Green (RoHS & no Sb/Br): TI defines "Green" to mean Pb-Free (RoHS compatible), and free of Bromine (Br) and Antimony (Sb) based flame retardants (Br or Sb do not exceed 0.1% by weight in homogeneous material)

(3) MSL, Peak Temp. - The Moisture Sensitivity Level rating according to the JEDEC industry standard classifications, and peak solder temperature.

(4) There may be additional marking, which relates to the logo, the lot trace code information, or the environmental category on the device.

(5) Multiple Device Markings will be inside parentheses. Only one Device Marking contained in parentheses and separated by a "~" will appear on a device. If a line is indented then it is a continuation of the previous line and the two combined represent the entire Device Marking for that device.

(6) Lead/Ball Finish - Orderable Devices may have multiple material finish options. Finish options are separated by a vertical ruled line. Lead/Ball Finish values may wrap to two lines if the finish value exceeds the maximum column width.

Important Information and Disclaimer:The information provided on this page represents TI's knowledge and belief as of the date that it is provided. TI bases its knowledge and belief on information provided by third parties, and makes no representation or warranty as to the accuracy of such information. Efforts are underway to better integrate information from third parties. TI has taken and

continues to take reasonable steps to provide representative and accurate information but may not have conducted destructive testing or chemical analysis on incoming materials and chemicals. TI and TI suppliers consider certain information to be proprietary, and thus CAS numbers and other limited information may not be available for release.

In no event shall TI's liability arising out of such information exceed the total purchase price of the TI part(s) at issue in this document sold by TI to Customer on an annual basis.

OTHER QUALIFIED VERSIONS OF TPS22965 :

- Automotive: [TPS22965-Q1](#)

NOTE: Qualified Version Definitions:

- Automotive - Q100 devices qualified for high-reliability automotive applications targeting zero defects

TAPE AND REEL INFORMATION



QUADRANT ASSIGNMENTS FOR PIN 1 ORIENTATION IN TAPE



*All dimensions are nominal

| Device | Package Type | Package Drawing | Pins | SPQ | Reel Diameter (mm) | Reel Width W1 (mm) | A0 (mm) | B0 (mm) | K0 (mm) | P1 (mm) | W (mm) | Pin1 Quadrant |
|---------------|--------------|-----------------|------|------|--------------------|--------------------|---------|---------|---------|---------|--------|---------------|
| TPS22965DSGR | WSON | DSG | 8 | 3000 | 180.0 | 8.4 | 2.3 | 2.3 | 1.15 | 4.0 | 8.0 | Q2 |
| TPS22965DSGT | WSON | DSG | 8 | 250 | 180.0 | 8.4 | 2.3 | 2.3 | 1.15 | 4.0 | 8.0 | Q2 |
| TPS22965NDSGR | WSON | DSG | 8 | 3000 | 180.0 | 8.4 | 2.3 | 2.3 | 1.15 | 4.0 | 8.0 | Q2 |

TAPE AND REEL BOX DIMENSIONS

*All dimensions are nominal

| Device | Package Type | Package Drawing | Pins | SPQ | Length (mm) | Width (mm) | Height (mm) |
|---------------|--------------|-----------------|------|------|-------------|------------|-------------|
| TPS22965DSGR | WSON | DSG | 8 | 3000 | 210.0 | 185.0 | 35.0 |
| TPS22965DSGT | WSON | DSG | 8 | 250 | 210.0 | 185.0 | 35.0 |
| TPS22965NDSGR | WSON | DSG | 8 | 3000 | 210.0 | 185.0 | 35.0 |

DSG (S-PWSON-N8)

PLASTIC SMALL OUTLINE NO-LEAD

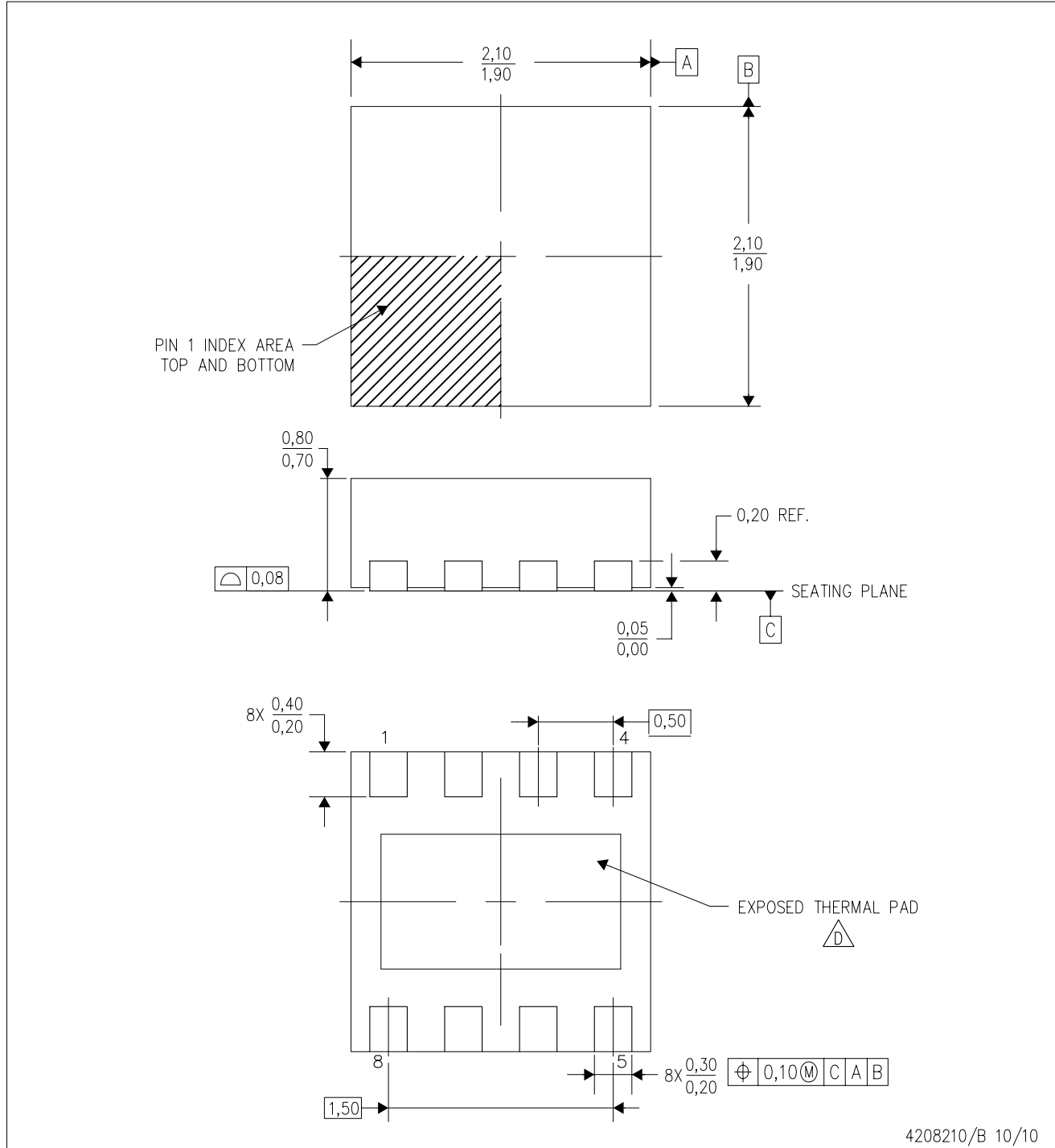

4208210/B 10/10

- NOTES:
- A. All linear dimensions are in millimeters. Dimensioning and tolerancing per ASME Y14.5M-1994.
 - B. This drawing is subject to change without notice.
 - C. Quad Flatpack, No-Leads (QFN) package configuration.
 -  The package thermal pad must be soldered to the board for thermal and mechanical performance. See the Product Data Sheet for details regarding the exposed thermal pad dimensions.
 - E. Falls within JEDEC MO-229.

THERMAL PAD MECHANICAL DATA

DSG (S-PWSON-N8)

PLASTIC SMALL OUTLINE NO-LEAD

THERMAL INFORMATION

This package incorporates an exposed thermal pad that is designed to be attached directly to an external heatsink. The thermal pad must be soldered directly to the printed circuit board (PCB). After soldering, the PCB can be used as a heatsink. In addition, through the use of thermal vias, the thermal pad can be attached directly to the appropriate copper plane shown in the electrical schematic for the device, or alternatively, can be attached to a special heatsink structure designed into the PCB. This design optimizes the heat transfer from the integrated circuit (IC).

For information on the Quad Flatpack No-Lead (QFN) package and its advantages, refer to Application Report, QFN/SON PCB Attachment, Texas Instruments Literature No. SLUA271. This document is available at www.ti.com.

The exposed thermal pad dimensions for this package are shown in the following illustration.

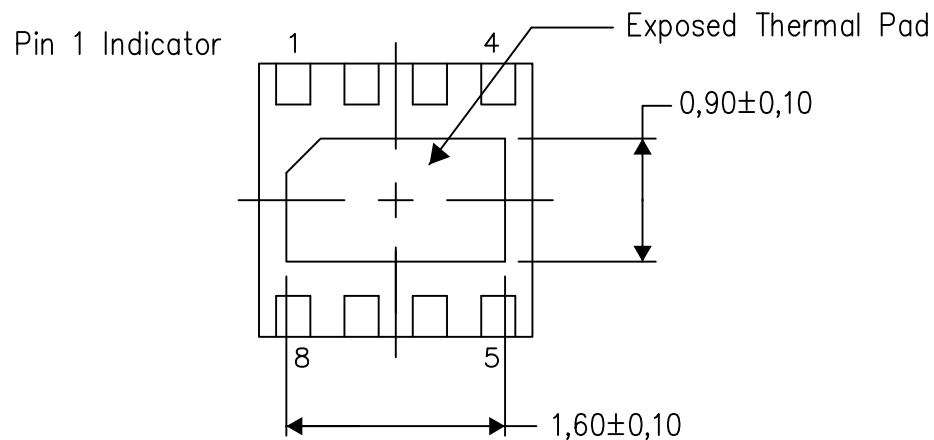

Bottom View

Exposed Thermal Pad Dimensions

4208347/H 04/15

NOTE: All linear dimensions are in millimeters

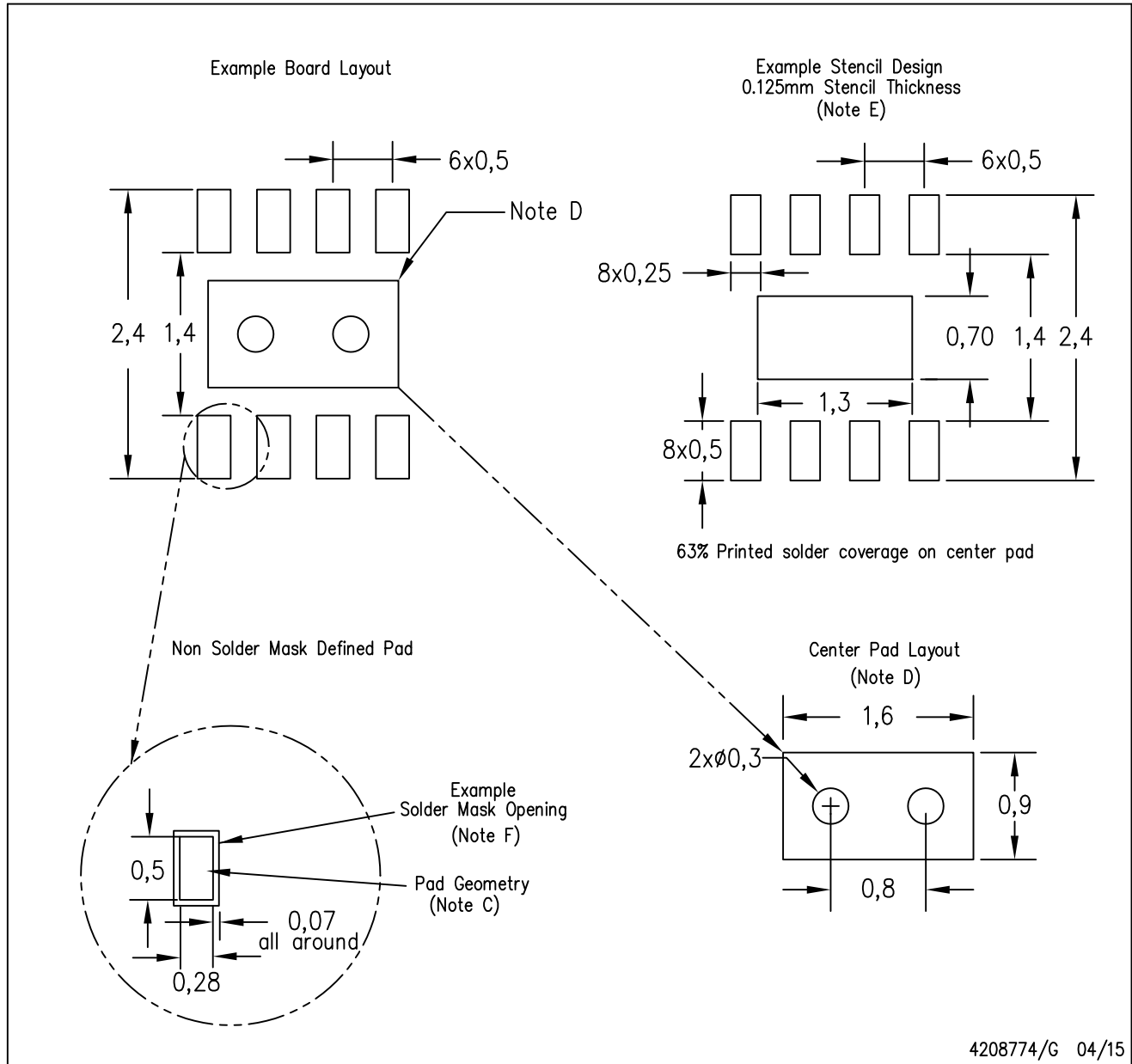

- NOTES:
- All linear dimensions are in millimeters.
 - This drawing is subject to change without notice.
 - Publication IPC-7351 is recommended for alternate designs.
 - This package is designed to be soldered to a thermal pad on the board. Refer to Application Note, QFN/SON PCB Attachment, Texas Instruments Literature No. SLUA271, and also the Product Data Sheets for specific thermal information, via requirements, and recommended board layout. These documents are available at www.ti.com <<http://www.ti.com>>.
 - Laser cutting apertures with trapezoidal walls and also rounding corners will offer better paste release. Customers should contact their board assembly site for stencil design recommendations. Refer to IPC 7525 for stencil design considerations.
 - Customers should contact their board fabrication site for solder mask tolerances.

IMPORTANT NOTICE

Texas Instruments Incorporated and its subsidiaries (TI) reserve the right to make corrections, enhancements, improvements and other changes to its semiconductor products and services per JESD46, latest issue, and to discontinue any product or service per JESD48, latest issue. Buyers should obtain the latest relevant information before placing orders and should verify that such information is current and complete. All semiconductor products (also referred to herein as "components") are sold subject to TI's terms and conditions of sale supplied at the time of order acknowledgment.

TI warrants performance of its components to the specifications applicable at the time of sale, in accordance with the warranty in TI's terms and conditions of sale of semiconductor products. Testing and other quality control techniques are used to the extent TI deems necessary to support this warranty. Except where mandated by applicable law, testing of all parameters of each component is not necessarily performed.

TI assumes no liability for applications assistance or the design of Buyers' products. Buyers are responsible for their products and applications using TI components. To minimize the risks associated with Buyers' products and applications, Buyers should provide adequate design and operating safeguards.

TI does not warrant or represent that any license, either express or implied, is granted under any patent right, copyright, mask work right, or other intellectual property right relating to any combination, machine, or process in which TI components or services are used. Information published by TI regarding third-party products or services does not constitute a license to use such products or services or a warranty or endorsement thereof. Use of such information may require a license from a third party under the patents or other intellectual property of the third party, or a license from TI under the patents or other intellectual property of TI.

Reproduction of significant portions of TI information in TI data books or data sheets is permissible only if reproduction is without alteration and is accompanied by all associated warranties, conditions, limitations, and notices. TI is not responsible or liable for such altered documentation. Information of third parties may be subject to additional restrictions.

Resale of TI components or services with statements different from or beyond the parameters stated by TI for that component or service voids all express and any implied warranties for the associated TI component or service and is an unfair and deceptive business practice. TI is not responsible or liable for any such statements.

Buyer acknowledges and agrees that it is solely responsible for compliance with all legal, regulatory and safety-related requirements concerning its products, and any use of TI components in its applications, notwithstanding any applications-related information or support that may be provided by TI. Buyer represents and agrees that it has all the necessary expertise to create and implement safeguards which anticipate dangerous consequences of failures, monitor failures and their consequences, lessen the likelihood of failures that might cause harm and take appropriate remedial actions. Buyer will fully indemnify TI and its representatives against any damages arising out of the use of any TI components in safety-critical applications.

In some cases, TI components may be promoted specifically to facilitate safety-related applications. With such components, TI's goal is to help enable customers to design and create their own end-product solutions that meet applicable functional safety standards and requirements. Nonetheless, such components are subject to these terms.

No TI components are authorized for use in FDA Class III (or similar life-critical medical equipment) unless authorized officers of the parties have executed a special agreement specifically governing such use.

Only those TI components which TI has specifically designated as military grade or "enhanced plastic" are designed and intended for use in military/aerospace applications or environments. Buyer acknowledges and agrees that any military or aerospace use of TI components which have **not** been so designated is solely at the Buyer's risk, and that Buyer is solely responsible for compliance with all legal and regulatory requirements in connection with such use.

TI has specifically designated certain components as meeting ISO/TS16949 requirements, mainly for automotive use. In any case of use of non-designated products, TI will not be responsible for any failure to meet ISO/TS16949.

Products

| | |
|------------------------------|--|
| Audio | www.ti.com/audio |
| Amplifiers | amplifier.ti.com |
| Data Converters | dataconverter.ti.com |
| DLP® Products | www.dlp.com |
| DSP | dsp.ti.com |
| Clocks and Timers | www.ti.com/clocks |
| Interface | interface.ti.com |
| Logic | logic.ti.com |
| Power Mgmt | power.ti.com |
| Microcontrollers | microcontroller.ti.com |
| RFID | www.ti-rfid.com |
| OMAP Applications Processors | www.ti.com/omap |
| Wireless Connectivity | www.ti.com/wirelessconnectivity |

Applications

| | |
|-------------------------------|--|
| Automotive and Transportation | www.ti.com/automotive |
| Communications and Telecom | www.ti.com/communications |
| Computers and Peripherals | www.ti.com/computers |
| Consumer Electronics | www.ti.com/consumer-apps |
| Energy and Lighting | www.ti.com/energy |
| Industrial | www.ti.com/industrial |
| Medical | www.ti.com/medical |
| Security | www.ti.com/security |
| Space, Avionics and Defense | www.ti.com/space-avionics-defense |
| Video and Imaging | www.ti.com/video |

TI E2E Community

e2e.ti.com