

VCA820 Wideband, > 40-dB Adjust Range, Linear in dB Variable Gain Amplifier

1 Features

- 150-MHz Small-Signal Bandwidth
- 137-MHz, 5-V_{pp} Bandwidth (G = +10 V/V)
- 0.1-dB Gain Flatness to 28 MHz
- 1700-V/μs Slew Rate
- > 40-dB Gain Adjust Range
- High Gain Accuracy: 20 dB ±0.4dB
- High Output Current: 160 mA

2 Applications

- AGC Receivers With RSSI
- Differential Line Receivers
- Pulse Amplitude Compensation
- Variable Attenuators

3 Description

The VCA820 is a dc-coupled, wideband, linear in dB, continuously variable, voltage-controlled gain amplifier. The VCA820 provides a differential input to single-ended conversion with a high-impedance gain control input, used to vary the gain down 40 dB from the nominal maximum gain set by the gain resistor (R_G) and feedback resistor (R_F).

The VCA820 internal architecture consists of two input buffers and an output current feedback amplifier stage, integrated with a multiplier core to provide a complete variable gain amplifier (VGA) system that does not require external buffering. The maximum gain is set externally with two resistors, providing flexibility in designs. The maximum gain is intended to be set between +2 V/V and +100 V/V. Operating from ±5-V supplies, the gain control voltage for the VCA820 adjusts the gain linearly in dB as the control voltage varies from 0 V to +2 V. For example, set for a maximum gain of +10 V/V, the VCA820 provides 20 dB, at +2-V input, to –20 dB at 0-V input of gain control range. The VCA820 offers excellent gain linearity. For a 20-dB maximum gain, and a gain-control input voltage varying between 1 V and 2 V, the gain does not deviate by more than ±0.4dB (maximum at +25°C).

Device Information⁽¹⁾

PART NUMBER	PACKAGE	BODY SIZE (NOM)
VCA820	SOIC (14)	8.65 mm × 3.91 mm
	VSSOP (10)	3.00 mm × 3.00 mm

(1) For all available packages, see the orderable addendum at the end of the data sheet.

Wideband Differential to Single-Ended Amplifier

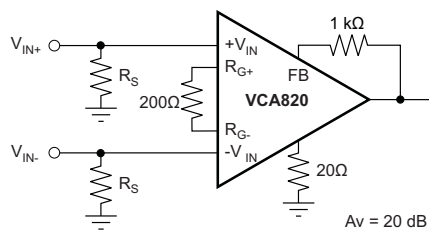

Common-Mode Rejection Ratio

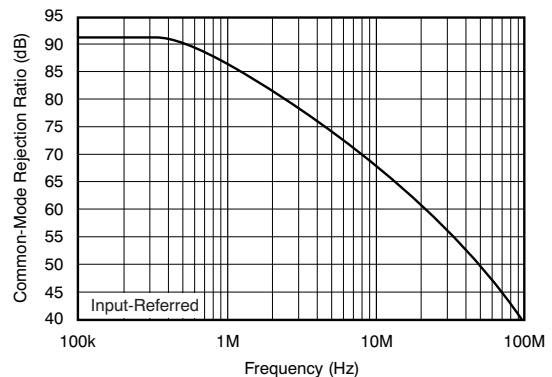

Table of Contents

1 Features	1	8.2 Functional Block Diagram	23
2 Applications	1	8.3 Feature Description	23
3 Description	1	8.4 Device Functional Modes	24
4 Revision History	2	9 Application and Implementation	27
5 Device Options	3	9.1 Application Information	27
6 Pin Configuration and Functions	3	9.2 Typical Applications	29
7 Specifications	4	9.3 System Examples	35
7.1 Absolute Maximum Ratings	4	10 Power Supply Recommendations	37
7.2 ESD Ratings	4	11 Layout	37
7.3 Recommended Operating Conditions	4	11.1 Layout Guidelines	37
7.4 Thermal Information	4	11.2 Layout Example	38
7.5 Electrical Characteristics: $V_S = \pm 5\text{ V}$	5	11.3 Thermal Considerations	38
7.6 Typical Characteristics: $V_S = \pm 5\text{ V}$, DC Parameters ..	9	12 Device and Documentation Support	39
7.7 Typical Characteristics: $V_S = \pm 5\text{ V}$, DC and Power-Supply Parameters	10	12.1 Device Support	39
7.8 Typical Characteristics: $V_S = \pm 5\text{ V}$, $A_{VMAX} = 6\text{ dB}$..	11	12.2 Community Resources	39
7.9 Typical Characteristics: $V_S = \pm 5\text{ V}$, $A_{VMAX} = 20\text{ dB}$..	15	12.3 Trademarks	39
7.10 Typical Characteristics: $V_S = \pm 5\text{ V}$, $A_{VMAX} = 40\text{ dB}$	19	12.4 Electrostatic Discharge Caution	39
8 Detailed Description	23	12.5 Glossary	39
8.1 Overview	23	13 Mechanical, Packaging, and Orderable Information	39

4 Revision History

NOTE: Page numbers for previous revisions may differ from page numbers in the current version.

Changes from Revision C (October 2009) to Revision D	Page
<ul style="list-style-type: none"> Added ESD Ratings table, Feature Description section, Device Functional Modes, Application and Implementation section, Power Supply Recommendations section, Layout section, Device and Documentation Support section, and Mechanical, Packaging, and Orderable Information section 	1

Changes from Revision B (December 2008) to Revision C	Page
Deleted lead temperature specification from Absolute Maximum Ratings table	4
Changed Figure 13; corrected y-axis units from V_{IN} (mV) to V_{OUT} (mV)	11
Changed Figure 14; corrected y-axis units from V_{IN} (mV) to V_{OUT} (V)	11
Changed Figure 33; corrected y-axis units from V_{IN} (mV) to V_{OUT} (mV)	15
Changed Figure 34; corrected y-axis units from V_{IN} (mV) to V_{OUT} (V)	15
Changed Figure 54; corrected y-axis units from V_{IN} (mV) to V_{OUT} (mV)	19
Changed Figure 55; corrected y-axis units from V_{IN} (mV) to V_{OUT} (V), corrected V_{IN} value in graph	19

Changes from Revision A (August 2008) to Revision B	Page
Revised second paragraph of the Wideband Variable Gain Amplifier Operation section describing pin 9	29

5 Device Options

Table 1. Wideband Variable Gain Amplifiers - VGAs

SINGLES	DUALS	GAIN ADJUST RANGE (dB)	INPUT NOISE (nV/√Hz)	SIGNAL BANDWIDTH (MHz)
VCA810	—	80	2.4	35
—	VCA2612	45	1.25	80
—	VCA2613	45	1	80
—	VCA2615	52	0.8	50
—	VCA2617	48	4.1	50
VCA820	—	40	8.2	150
VCA821	—	40	7.0	420
VCA822	—	40	8.2	150
VCA824	—	40	7.0	420

6 Pin Configuration and Functions



Pin Functions

NAME	PIN		I/O	DESCRIPTION
	SOIC	VSSOP		
GND	11	10	—	Ground
I ⁻	12	1	I	Feedback Resistor Input
-R _G	5	6	I	Gain Set Resistor
+R _G	4	5	I	Gain Set Resistor
V ⁻	7, 8	—	P	Negative Supply
V ⁺	1, 14	—	P	Positive Supply
-V	—	8	P	Negative Supply
+V	—	2	P	Positive Supply
V _G	2	3	I	Gain Control
-V _{IN}	6	7	I	Inverting Input
+V _{IN}	3	4	I	Noninverting Input
V _{OUT}	10	9	O	Output
V _{REF}	9	—	I	Output Voltage Reference

7 Specifications

7.1 Absolute Maximum Ratings

over operating free-air temperature range (unless otherwise noted)⁽¹⁾

	MIN	MAX	UNIT
Power supply		±6.3	V
Internal power dissipation	See Thermal Information		
Input voltage		±V _S	V
Junction temperature (T _J)		150	°C
Junction temperature (T _J), maximum continuous operation		140	°C
Storage temperature	–65	125	°C

- (1) Stresses beyond those listed under *Absolute Maximum Ratings* may cause permanent damage to the device. These are stress ratings only, which do not imply functional operation of the device at these or any other conditions beyond those indicated under *Recommended Operating Conditions*. Exposure to absolute-maximum-rated conditions for extended periods may affect device reliability.

7.2 ESD Ratings

		VALUE	UNIT
V _(ESD) Electrostatic discharge	Human body model (HBM), per ANSI/ESDA/JEDEC JS-001 ⁽¹⁾	±2000	V
	Charged device model (CDM), per JEDEC specification JESD22-C101 ⁽²⁾	±500	
	Machine model (MM)	±200	

- (1) JEDEC document JEP155 states that 500-V HBM allows safe manufacturing with a standard ESD control process.

- (2) JEDEC document JEP157 states that 250-V CDM allows safe manufacturing with a standard ESD control process.

7.3 Recommended Operating Conditions

over operating free-air temperature range (unless otherwise noted)

	MIN	NOM	MAX	UNIT
Operating voltage	7	10	12	V
Operating temperature	–40	25	85	°C

7.4 Thermal Information

THERMAL METRIC ⁽¹⁾	VCA820		UNIT
	D [SOIC]	DGS [VSSOP]	
	14 PINS	10 PINS	
R _{θJA} Junction-to-ambient thermal resistance	80	130	°C/W
R _{θJC(top)} Junction-to-case (top) thermal resistance	49.8	46.6	°C/W
R _{θJB} Junction-to-board thermal resistance	44.9	94.3	°C/W
Ψ _{JT} Junction-to-top characterization parameter	13.8	2.2	°C/W
Ψ _{JB} Junction-to-board characterization parameter	44.6	92.7	°C/W
R _{θJC(bot)} Junction-to-case (bottom) thermal resistance	n/a	n/a	°C/W

- (1) For more information about traditional and new thermal metrics, see the *Semiconductor and IC Package Thermal Metrics* application report, [SPRA953](#).

7.5 Electrical Characteristics: $V_S = \pm 5\text{ V}$

At $A_{VMAX} = 20\text{ dB}$, $R_F = 1\text{ k}\Omega$, $R_G = 200\ \Omega$, and $R_L = 100\ \Omega$, unless otherwise noted.

PARAMETER	TEST CONDITIONS	MIN	TYP	MAX	UNIT	TEST LEVEL ⁽¹⁾	
AC PERFORMANCE							
Small-signal bandwidth (SO-14 package)	$A_{VMAX} = 6\text{ dB}$, $V_O = 1\text{ V}_{PP}$, $V_G = +2\text{ V}$	$T_J = 25^\circ\text{C}$		168	MHz	C	
	$A_{VMAX} = 20\text{ dB}$, $V_O = 1\text{ V}_{PP}$, $V_G = +2\text{ V}$	$T_J = 25^\circ\text{C}$		150			
	$A_{VMAX} = 40\text{ dB}$, $V_O = 1\text{ V}_{PP}$, $V_G = +2\text{ V}$	$T_J = 25^\circ\text{C}$		118			
Large-signal bandwidth	$A_{VMAX} = 20\text{ dB}$, $V_O = 5\text{ V}_{PP}$, $V_G = +2\text{ V}$	$T_J = 25^\circ\text{C}$		137	MHz	C	
Gain control bandwidth	$V_G = 1\text{ V}_{DC} + 10\text{ mV}_{PP}$	$T_J = 25^\circ\text{C}$	170	200	MHz	B	
		$T_J = 0^\circ\text{C to } 70^\circ\text{C}^{(2)}$	170				
		$T_J = -40^\circ\text{C to } 85^\circ\text{C}^{(2)}$	165				
Bandwidth for 0.1dB flatness	$A_{VMAX} = 20\text{ dB}$, $V_O = 1\text{ V}_{PP}$, $V_G = +2\text{ V}$	$T_J = 25^\circ\text{C}$		28	MHz	C	
Slew rate	$A_{VMAX} = 20\text{ dB}$, $V_O = 5\text{-V step}$, $V_G = +2\text{ V}$	$T_J = 25^\circ\text{C}$	1500	1700	V/ μs	B	
		$T_J = 0^\circ\text{C to } 70^\circ\text{C}^{(2)}$	1500				
		$T_J = -40^\circ\text{C to } 85^\circ\text{C}^{(2)}$	1450				
Rise-and-fall time	$A_{VMAX} = 20\text{ dB}$, $V_O = 5\text{-V step}$, $V_G = +2\text{ V}$	$T_J = 25^\circ\text{C}$		2.5	3.1	ns	B
		$T_J = 0^\circ\text{C to } 70^\circ\text{C}^{(2)}$			3.2		
		$T_J = -40^\circ\text{C to } 85^\circ\text{C}^{(2)}$			3.2		
Settling time to 0.01%	$A_{VMAX} = 20\text{ dB}$, $V_O = 5\text{-V step}$, $V_G = +2\text{ V}$	$T_J = 25^\circ\text{C}$		11	ns	C	
HARMONIC DISTORTION							
2nd-harmonic	$V_O = 2\text{ V}_{PP}$, $f = 20\text{ MHz}$	$T_J = 25^\circ\text{C}$	-60	-62	dBc	B	
		$T_J = 0^\circ\text{C to } 70^\circ\text{C}^{(2)}$	-60				
		$T_J = -40^\circ\text{C to } 85^\circ\text{C}^{(2)}$	-60				
3rd-harmonic	$V_O = 2\text{ V}_{PP}$, $f = 20\text{ MHz}$	$T_J = 25^\circ\text{C}$	-66	-68	dBc	B	
		$T_J = 0^\circ\text{C to } 70^\circ\text{C}^{(2)}$	-66				
		$T_J = -40^\circ\text{C to } 85^\circ\text{C}^{(2)}$	-66				
Input voltage noise	$f > 100\text{ kHz}$	$T_J = 25^\circ\text{C}$		8.2	nV/ $\sqrt{\text{Hz}}$	C	
Input current noise	$f > 100\text{ kHz}$	$T_J = 25^\circ\text{C}$		2.6	pA/ $\sqrt{\text{Hz}}$		
GAIN CONTROL							
Absolute gain error	$A_{VMAX} = 20\text{ dB}$, $V_G = 2\text{ V}$	$T_J = 25^\circ\text{C}$		± 0.1	± 0.4	dB	A
		$T_J = 0^\circ\text{C to } 70^\circ\text{C}^{(2)}$			± 0.5		
		$T_J = -40^\circ\text{C to } 85^\circ\text{C}^{(2)}$			± 0.6		
V_{CTRL0}		$T_J = 25^\circ\text{C}$		0.85	V	C	
V_{SLOPE}		$T_J = 25^\circ\text{C}$		0.09	V	C	
Absolute gain error	$A_{VMAX} = 20\text{ dB}$, $V_G = 1\text{ V}$, ($G = 18.06\text{ dB}$)	$T_J = 25^\circ\text{C}$		± 0.3	± 0.4	dB	A
		$T_J = 0^\circ\text{C to } 70^\circ\text{C}^{(2)}$			± 0.5		
		$T_J = -40^\circ\text{C to } 85^\circ\text{C}^{(2)}$			± 0.6		

- (1) Test levels: **(A)** 100% tested at $+25^\circ\text{C}$. Over temperature limits set by characterization and simulation. **(B)** Limits set by characterization and simulation. **(C)** Typical value only for information.
- (2) Junction temperature = ambient at low temperature limit; junction temperature = ambient $+23^\circ\text{C}$ at high temperature limit for over temperature specifications.

Electrical Characteristics: $V_S = \pm 5\text{ V}$ (continued)

 At $A_{V_{MAX}} = 20\text{ dB}$, $R_F = 1\text{ k}\Omega$, $R_G = 200\ \Omega$, and $R_L = 100\ \Omega$, unless otherwise noted.

PARAMETER	TEST CONDITIONS	MIN	TYP	MAX	UNIT	TEST LEVEL ⁽¹⁾
Gain at $V_G = 0.2\text{V}$	Relative to maximum gain	$T_J = 25^\circ\text{C}$	-26	-24	dB	A
		$T_J = 0^\circ\text{C to } 70^\circ\text{C}^{(2)}$		-24		
		$T_J = -40^\circ\text{C to } 85^\circ\text{C}^{(2)}$		-23		
Gain at $V_G = 0.2\text{V}$	Relative to maximum gain	$T_J = 25^\circ\text{C}$	-26	-24	dB	A
		$T_J = 0^\circ\text{C to } 70^\circ\text{C}^{(2)}$		-24		
		$T_J = -40^\circ\text{C to } 85^\circ\text{C}^{(2)}$		-23		
Gain control bias current		$T_J = 25^\circ\text{C}$	10	16	μA	A
		$T_J = 0^\circ\text{C to } 70^\circ\text{C}^{(2)}$		16.6		
		$T_J = -40^\circ\text{C to } 85^\circ\text{C}^{(2)}$		16.7		
Average gain control bias current drift		$T_J = 0^\circ\text{C to } 70^\circ\text{C}^{(2)}$		± 12	$\text{nA}/^\circ\text{C}$	B
		$T_J = -40^\circ\text{C to } 85^\circ\text{C}^{(2)}$		± 12		
Gain control input impedance	$T_J = 25^\circ\text{C}$		$70 \parallel 1$		$\text{k}\Omega \parallel \text{pF}$	C
DC PERFORMANCE						
Input offset voltage	$A_{V_{MAX}} = 20\text{ dB}$, $V_{CM} = 0\text{ V}$, $V_G = 1\text{ V}$	$T_J = 25^\circ\text{C}$	± 4	± 17	mV	A
		$T_J = 0^\circ\text{C to } 70^\circ\text{C}^{(2)}$		± 17.8		
		$T_J = -40^\circ\text{C to } 85^\circ\text{C}^{(2)}$		± 19		
Average input offset voltage drift	$A_{V_{MAX}} = 20\text{ dB}$, $V_{CM} = 0\text{ V}$, $V_G = 1\text{ V}$	$T_J = 0^\circ\text{C to } 70^\circ\text{C}^{(2)}$		30	$\mu\text{V}/^\circ\text{C}$	B
		$T_J = -40^\circ\text{C to } 85^\circ\text{C}^{(2)}$		30		
Input bias current	$A_{V_{MAX}} = 20\text{ dB}$, $V_{CM} = 0\text{ V}$, $V_G = 1\text{ V}$	$T_J = 25^\circ\text{C}$	19	25	μA	A
		$T_J = 0^\circ\text{C to } 70^\circ\text{C}^{(2)}$		29		
		$T_J = -40^\circ\text{C to } 85^\circ\text{C}^{(2)}$		31		
Average input bias current drift	$A_{V_{MAX}} = 20\text{ dB}$, $V_{CM} = 0\text{ V}$, $V_G = 1\text{ V}$	$T_J = 0^\circ\text{C to } 70^\circ\text{C}^{(2)}$		90	$\text{nA}/^\circ\text{C}$	B
		$T_J = -40^\circ\text{C to } 85^\circ\text{C}^{(2)}$		90		
Input offset current	$A_{V_{MAX}} = 20\text{ dB}$, $V_{CM} = 0\text{ V}$, $V_G = 1\text{ V}$	$T_J = 25^\circ\text{C}$	± 0.5	± 2.5	μA	A
		$T_J = 0^\circ\text{C to } 70^\circ\text{C}^{(2)}$		± 3.2		
		$T_J = -40^\circ\text{C to } 85^\circ\text{C}^{(2)}$		± 3.5		
Average input offset current drift	$A_{V_{MAX}} = 20\text{ dB}$, $V_{CM} = 0\text{ V}$, $V_G = 1\text{ V}$	$T_J = 0^\circ\text{C to } 70^\circ\text{C}^{(2)}$		± 16	$\text{nA}/^\circ\text{C}$	B
		$T_J = -40^\circ\text{C to } 85^\circ\text{C}^{(2)}$		± 16		
Maximum current through gain resistance		$T_J = 25^\circ\text{C}$	± 2.6	± 2.55	mA	B
		$T_J = 0^\circ\text{C to } 70^\circ\text{C}^{(2)}$		± 2.55		
		$T_J = -40^\circ\text{C to } 85^\circ\text{C}^{(2)}$		± 2.5		

Electrical Characteristics: $V_S = \pm 5\text{ V}$ (continued)

At $A_{V_{MAX}} = 20\text{ dB}$, $R_F = 1\text{ k}\Omega$, $R_G = 200\ \Omega$, and $R_L = 100\ \Omega$, unless otherwise noted.

PARAMETER	TEST CONDITIONS	MIN	TYP	MAX	UNIT	TEST LEVEL ⁽¹⁾
INPUT						
Most positive common-mode input voltage	$R_L = 100\ \Omega$	$T_J = 25^\circ\text{C}$	+1.6	+1.6	V	A
		$T_J = 0^\circ\text{C to } 70^\circ\text{C}^{(2)}$	+1.6			
		$T_J = -40^\circ\text{C to } 85^\circ\text{C}^{(2)}$	+1.6			
Most negative common-mode input voltage	$R_L = 100\ \Omega$	$T_J = 25^\circ\text{C}$		-2.1	V	A
		$T_J = 0^\circ\text{C to } 70^\circ\text{C}^{(2)}$		-2.1		
		$T_J = -40^\circ\text{C to } 85^\circ\text{C}^{(2)}$		-2.1		
Common-mode rejection ratio	$V_{CM} = \pm 0.5\text{ V}$	$T_J = 25^\circ\text{C}$	65	80	dB	A
		$T_J = 0^\circ\text{C to } 70^\circ\text{C}^{(2)}$	60			
		$T_J = -40^\circ\text{C to } 85^\circ\text{C}^{(2)}$	60			
Input impedance						
Differential		$T_J = 25^\circ\text{C}$	0.5 1		M Ω pF	C
Common-mode		$T_J = 25^\circ\text{C}$	0.5 2		M Ω pF	C
OUTPUT						
Output voltage swing	$R_L = 1\text{ k}\Omega$	$T_J = 25^\circ\text{C}$	± 3.8	± 4.0	V	A
		$T_J = 0^\circ\text{C to } 70^\circ\text{C}^{(2)}$	± 3.75			
		$T_J = -40^\circ\text{C to } 85^\circ\text{C}^{(2)}$	± 3.7			
	$R_L = 100\ \Omega$	$T_J = 25^\circ\text{C}$	± 3.7	± 3.9	V	A
		$T_J = 0^\circ\text{C to } 70^\circ\text{C}^{(2)}$	± 3.6			
		$T_J = -40^\circ\text{C to } 85^\circ\text{C}^{(2)}$	± 3.5			
Output current	$V_O = 0\text{ V}$, $R_L = 5\ \Omega$	$T_J = 25^\circ\text{C}$	± 140	± 160	mA	A
		$T_J = 0^\circ\text{C to } 70^\circ\text{C}^{(2)}$	± 130			
		$T_J = -40^\circ\text{C to } 85^\circ\text{C}^{(2)}$	± 130			
Output impedance	$A_{V_{MAX}} = 20\text{ dB}$, $f > 100\text{ kHz}$, $V_G = +2\text{ V}$	$T_J = 25^\circ\text{C}$	0.01		Ω	C
POWER SUPPLY						
Specified operating voltage		$T_J = 25^\circ\text{C}$	± 5		V	C
Minimum operating voltage		$T_J = 25^\circ\text{C}$	± 3.5		V	C
Maximum operating voltage		$T_J = 25^\circ\text{C}$		± 6	V	A
		$T_J = 0^\circ\text{C to } 70^\circ\text{C}^{(2)}$		± 6		
		$T_J = -40^\circ\text{C to } 85^\circ\text{C}^{(2)}$		± 6		
Maximum quiescent current	$V_G = 1\text{ V}$	$T_J = 25^\circ\text{C}$	34	35	mA	A
		$T_J = 0^\circ\text{C to } 70^\circ\text{C}^{(2)}$		35.5		
		$T_J = -40^\circ\text{C to } 85^\circ\text{C}^{(2)}$		36		
Minimum quiescent current	$V_G = 1\text{ V}$	$T_J = 25^\circ\text{C}$	34	32.5	mA	A
		$T_J = 0^\circ\text{C to } 70^\circ\text{C}^{(2)}$		32		
		$T_J = -40^\circ\text{C to } 85^\circ\text{C}^{(2)}$		31.5		

VCA820

SBOS395D – OCTOBER 2007 – REVISED SEPTEMBER 2015

www.ti.com
Electrical Characteristics: $V_S = \pm 5\text{ V}$ (continued)

 At $A_{VMAX} = 20\text{ dB}$, $R_F = 1\text{ k}\Omega$, $R_G = 200\ \Omega$, and $R_L = 100\ \Omega$, unless otherwise noted.

PARAMETER	TEST CONDITIONS	MIN	TYP	MAX	UNIT	TEST LEVEL ⁽¹⁾
Power-supply rejection ratio (-PSRR)	$T_J = 25^\circ\text{C}$	-61	-68		dB	A
	$T_J = 0^\circ\text{C to } 70^\circ\text{C}^{(2)}$	-59				
	$T_J = -40^\circ\text{C to } 85^\circ\text{C}^{(2)}$	-58				

7.6 Typical Characteristics: $V_S = \pm 5\text{ V}$, DC Parameters

At $T_A = +25^\circ\text{C}$, $R_L = 100\ \Omega$, $V_G = +1\text{ V}$, and V_{IN} = single-ended input on $+V_{IN}$ with $-V_{IN}$ at ground, unless otherwise noted.

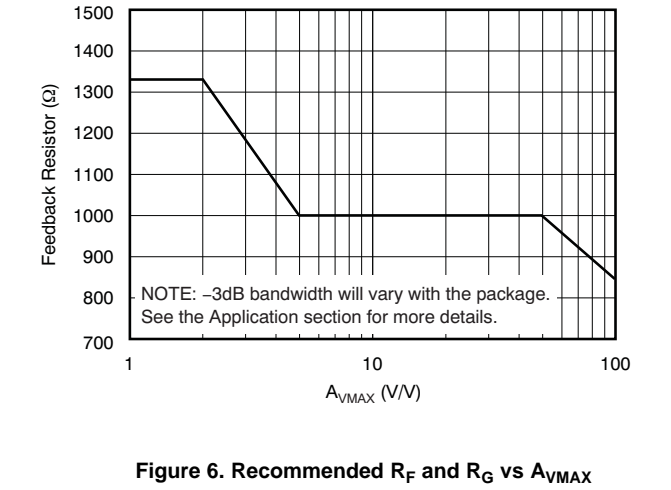
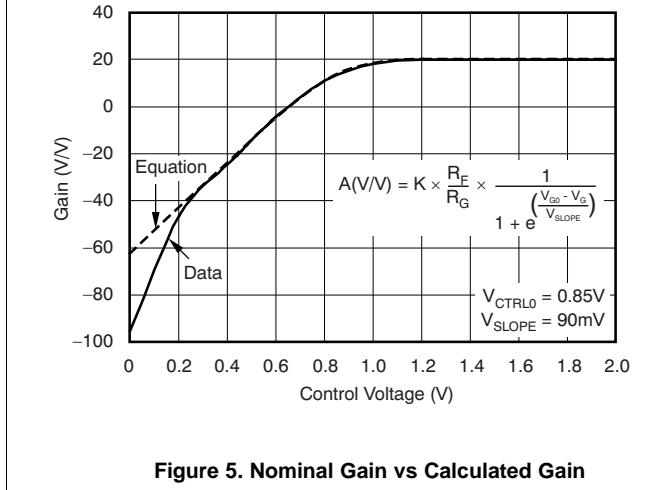
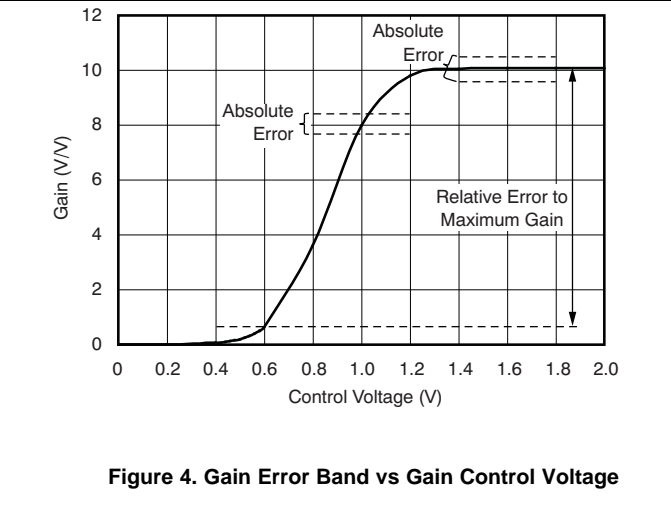
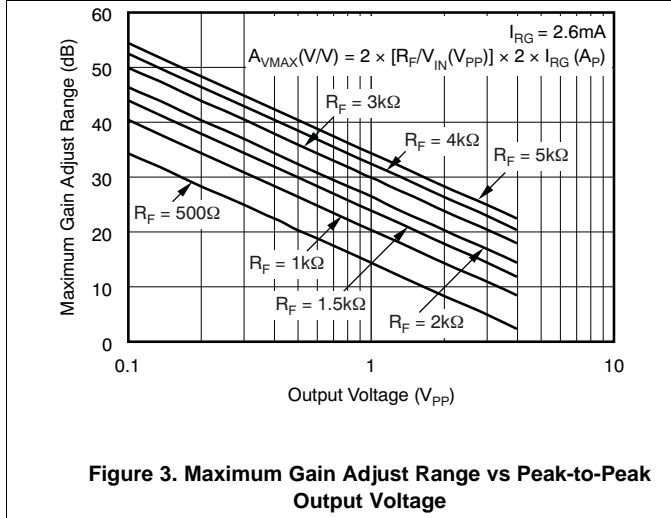
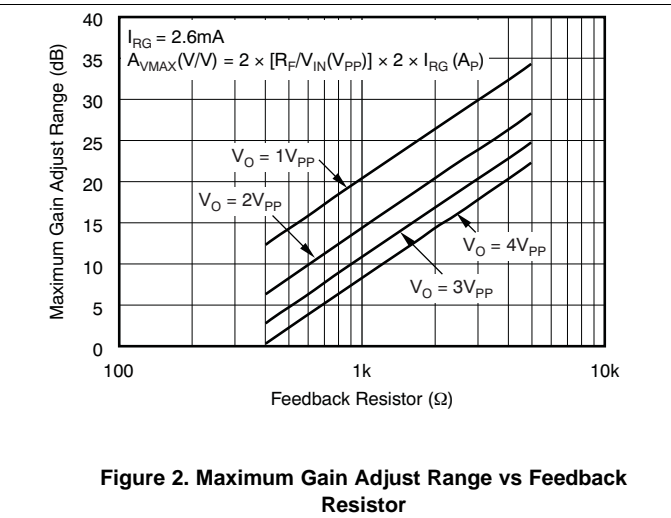
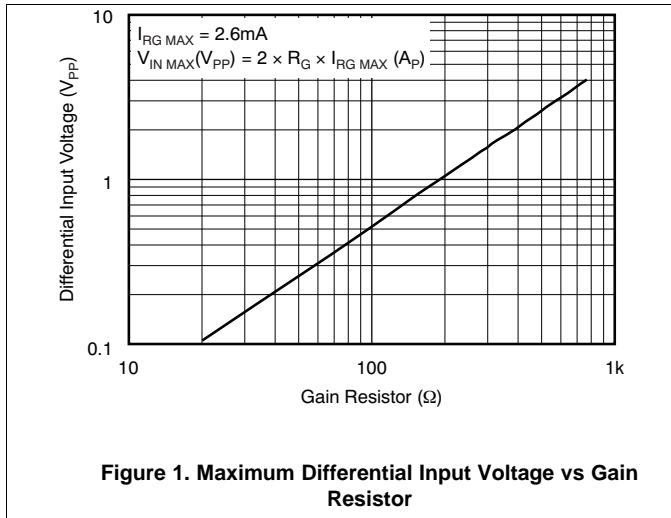

7.7 Typical Characteristics: $V_S = \pm 5\text{ V}$, DC and Power-Supply Parameters

At $T_A = +25^\circ\text{C}$, $R_L = 100\ \Omega$, $V_G = +1\text{ V}$, and V_{IN} = single-ended input on $+V_{IN}$ with $-V_{IN}$ at ground, unless otherwise noted.

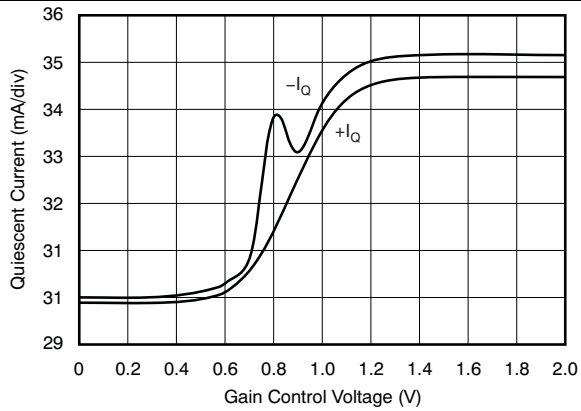

Figure 7. Supply Current vs Control Voltage ($A_{VMAX} = 6\text{ dB}$)

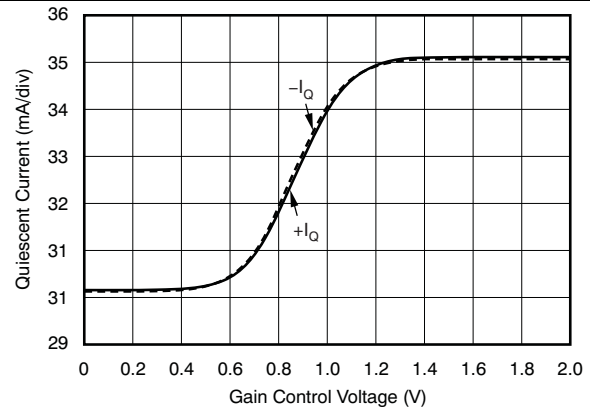

Figure 8. Supply Current vs Control Voltage ($A_{VMAX} = 20\text{ dB}$)

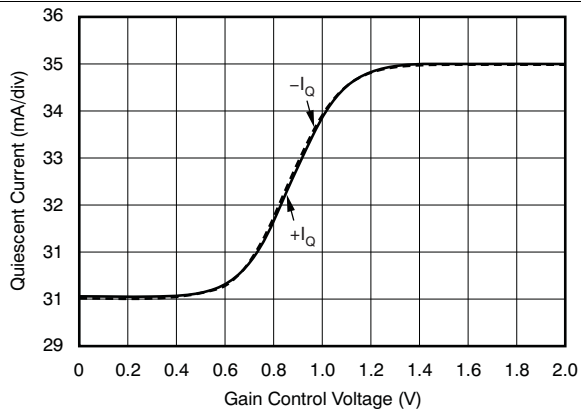

Figure 9. Supply Current vs Control Voltage ($A_{VMAX} = 40\text{ dB}$)

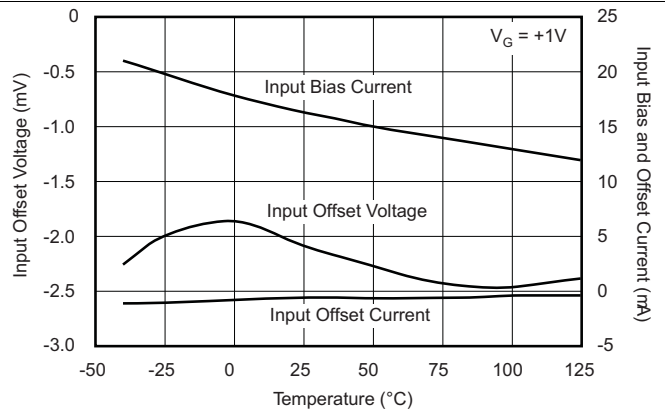

Figure 10. Typical DC Drift vs Temperature

7.8 Typical Characteristics: $V_S = \pm 5\text{ V}$, $A_{VMAX} = 6\text{ dB}$

At $T_A = +25^\circ\text{C}$, $R_L = 100\ \Omega$, $R_F = 1.33\ \text{k}\Omega$, $R_G = 1.33\ \text{k}\Omega$, $V_G = +2\text{ V}$, V_{IN} = single-ended input on $+V_{IN}$ with $-V_{IN}$ at ground, and SO-14 package, unless otherwise noted.

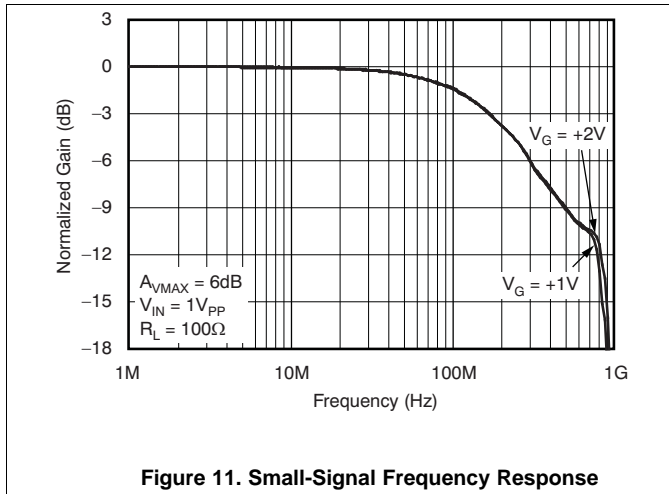

Figure 11. Small-Signal Frequency Response

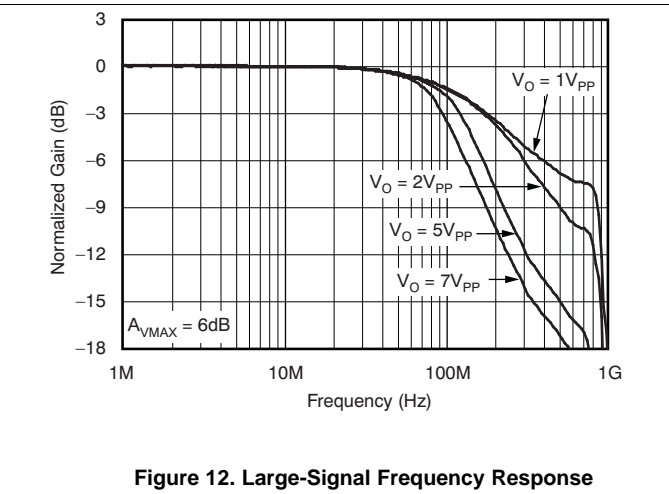

Figure 12. Large-Signal Frequency Response

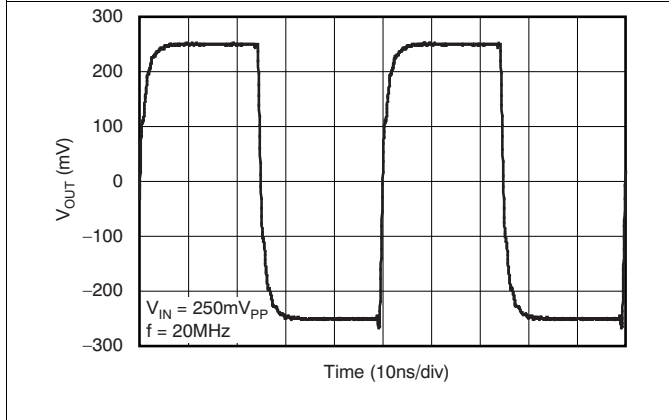

Figure 13. Small-Signal Pulse Response

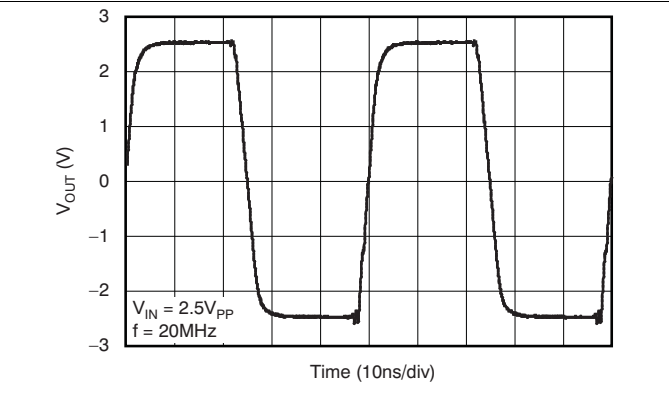

Figure 14. Large-Signal Pulse Response

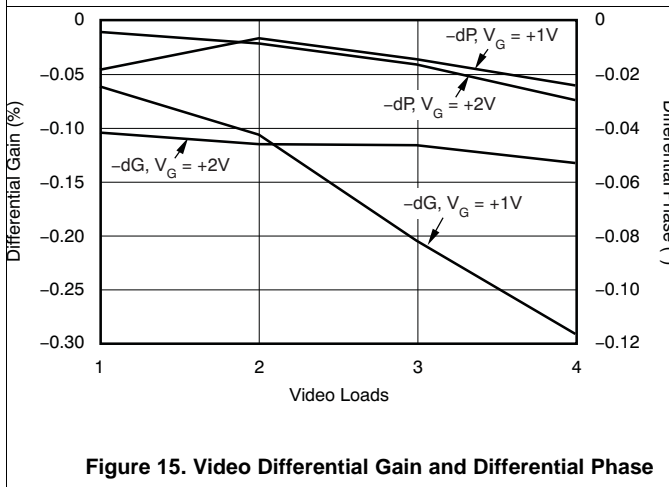

Figure 15. Video Differential Gain and Differential Phase

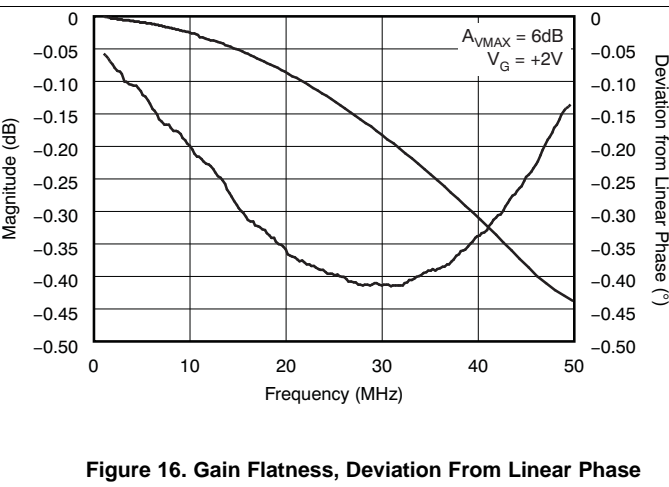

Figure 16. Gain Flatness, Deviation From Linear Phase

Typical Characteristics: $V_S = \pm 5\text{ V}$, $A_{VMAX} = 6\text{ dB}$ (continued)

At $T_A = +25^\circ\text{C}$, $R_L = 100\ \Omega$, $R_F = 1.33\ \text{k}\Omega$, $R_G = 1.33\ \text{k}\Omega$, $V_G = +2\ \text{V}$, V_{IN} = single-ended input on $+V_{IN}$ with $-V_{IN}$ at ground, and SO-14 package, unless otherwise noted.

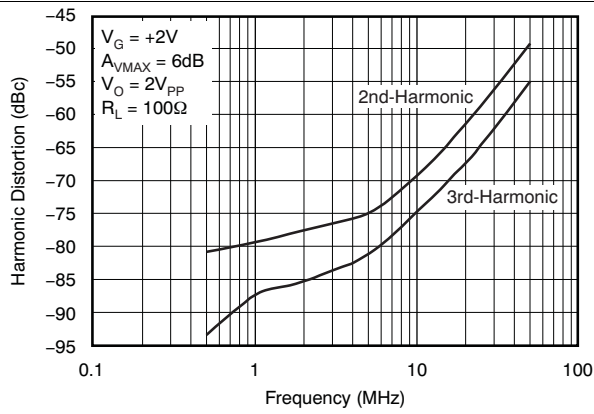

Figure 17. Harmonic Distortion vs Frequency

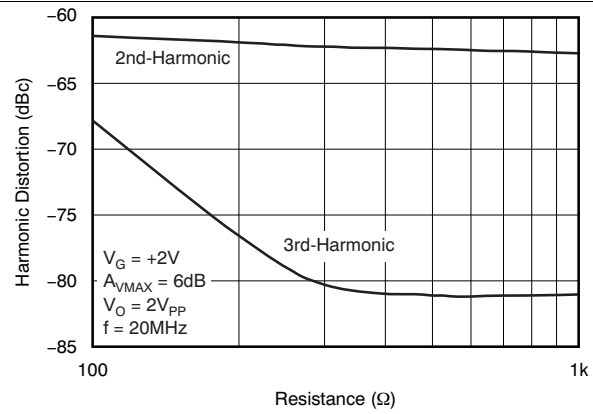

Figure 18. Harmonic Distortion vs Load Resistance

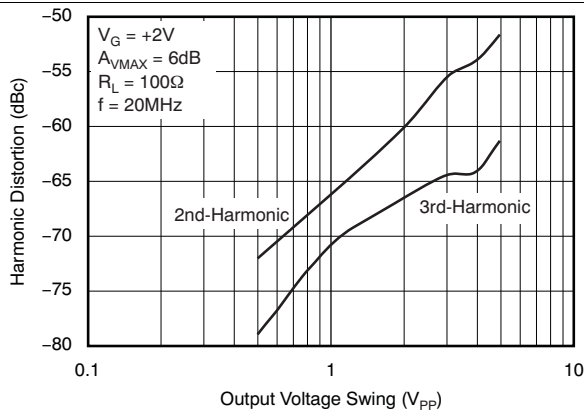

Figure 19. Harmonic Distortion vs Output Voltage

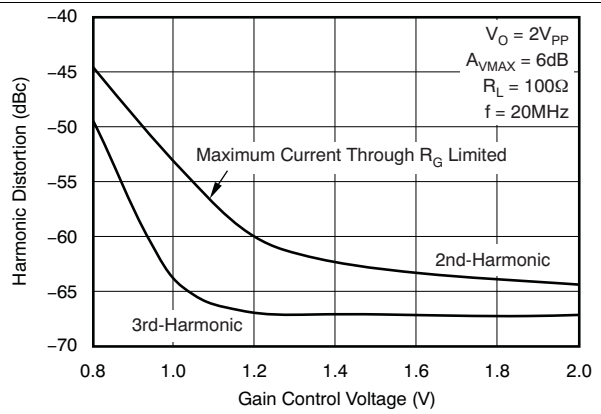

Figure 20. 20-MHz Harmonic Distortion vs Gain Control Voltage

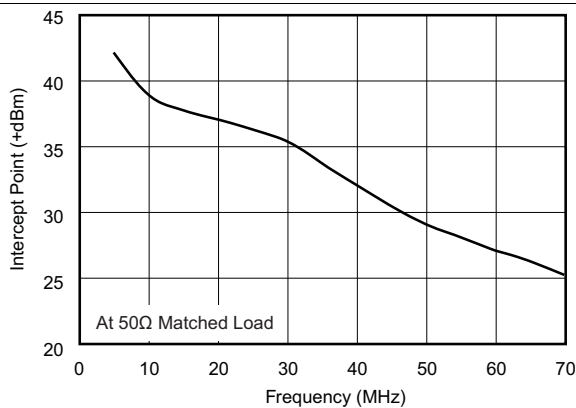

Figure 21. 2-Tone, 3rd-Order Intermodulation Intercept

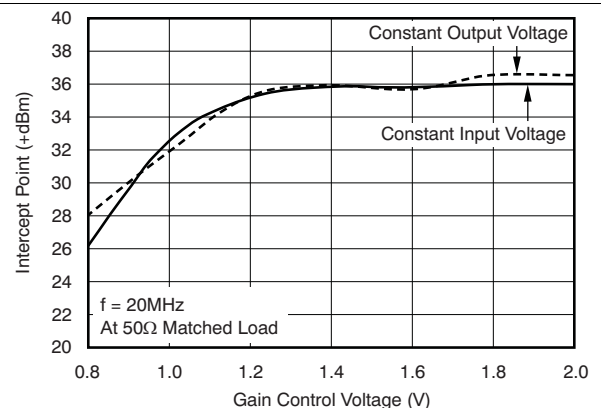

Figure 22. 2-Tone, 3rd-Order Intermodulation Intercept vs Gain Control Voltage

Typical Characteristics: $V_S = \pm 5\text{ V}$, $A_{VMAX} = 6\text{ dB}$ (continued)

At $T_A = +25^\circ\text{C}$, $R_L = 100\ \Omega$, $R_F = 1.33\ \text{k}\Omega$, $R_G = 1.33\ \text{k}\Omega$, $V_G = +2\text{ V}$, V_{IN} = single-ended input on $+V_{IN}$ with $-V_{IN}$ at ground, and SO-14 package, unless otherwise noted.

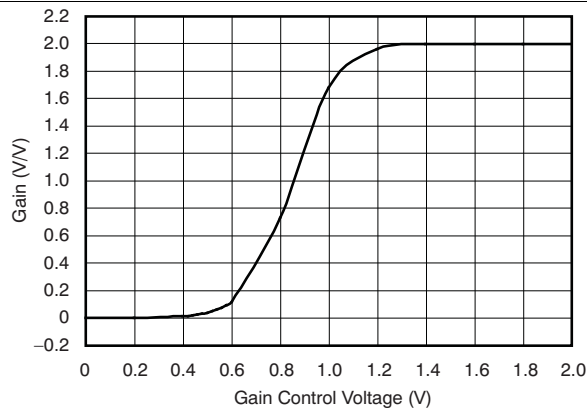

Figure 23. Gain vs Gain Control Voltage

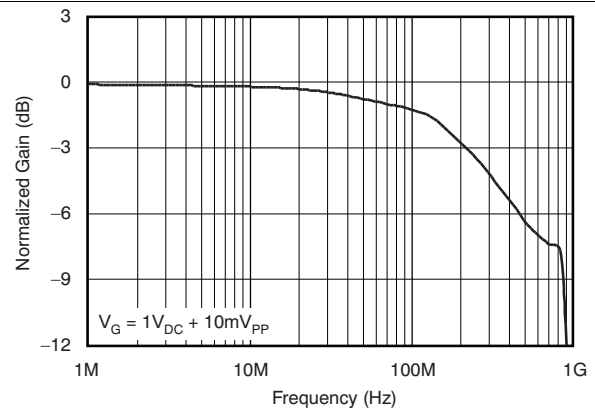

Figure 24. Frequency Response

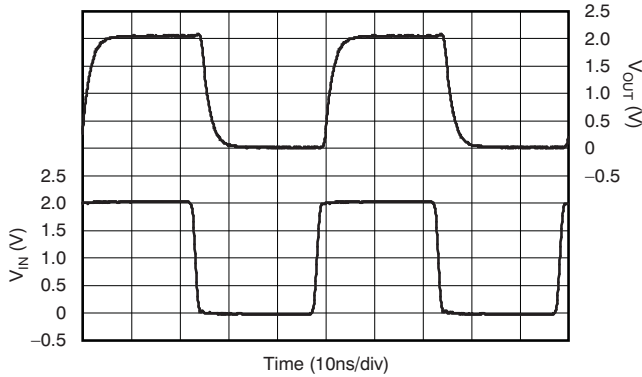

Figure 25. Gain Control Pulse Response

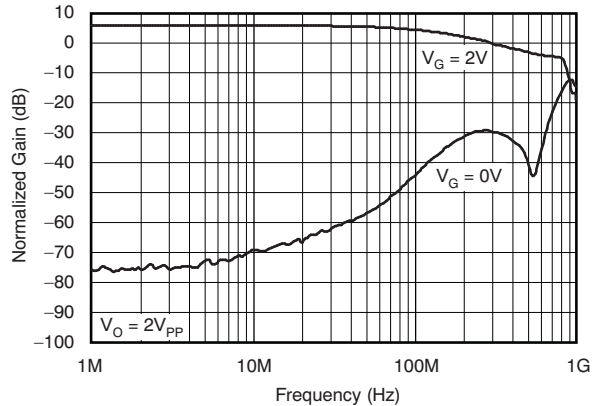

Figure 26. Fully-Attenuated Response

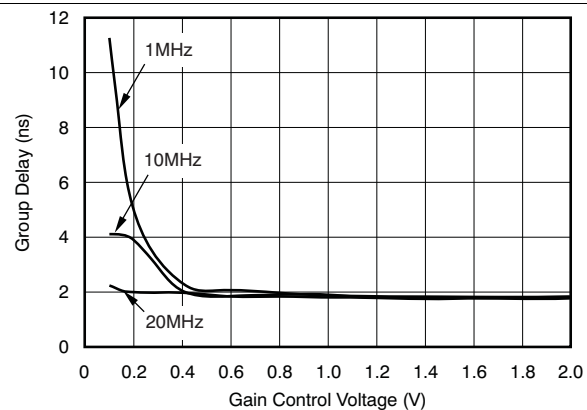

Figure 27. Group Delay vs Gain Control Voltage

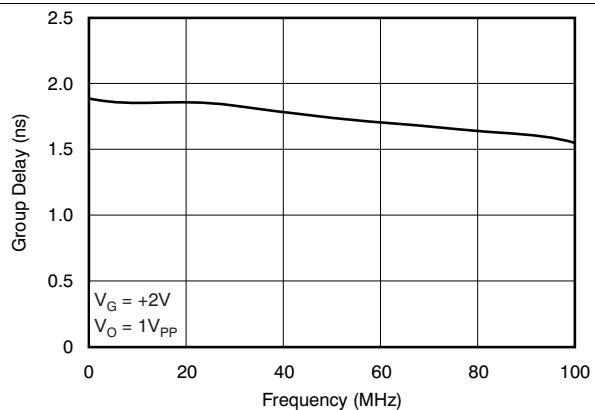

Figure 28. Group Delay vs Frequency

VCA820

SBOS395D – OCTOBER 2007 – REVISED SEPTEMBER 2015

www.ti.com

Typical Characteristics: $V_S = \pm 5\text{ V}$, $A_{VMAX} = 6\text{ dB}$ (continued)

At $T_A = +25^\circ\text{C}$, $R_L = 100\ \Omega$, $R_F = 1.33\text{ k}\Omega$, $R_G = 1.33\text{ k}\Omega$, $V_G = +2\text{ V}$, V_{IN} = single-ended input on $+V_{IN}$ with $-V_{IN}$ at ground, and SO-14 package, unless otherwise noted.

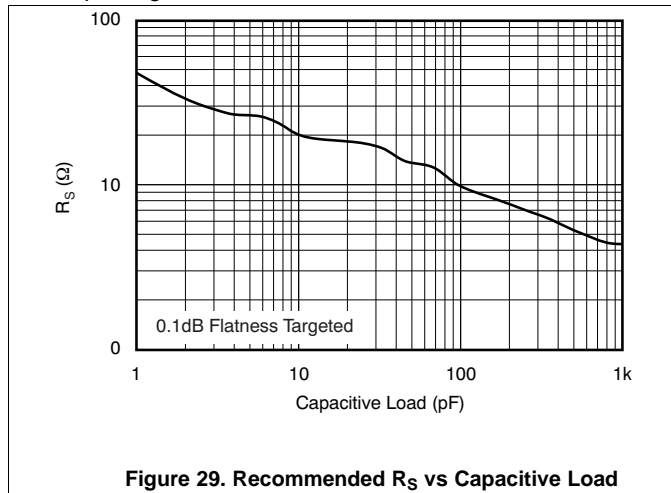

Figure 29. Recommended R_S vs Capacitive Load

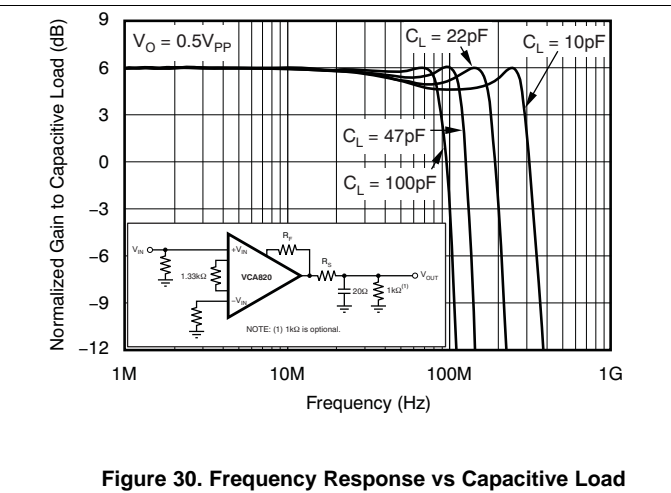

Figure 30. Frequency Response vs Capacitive Load

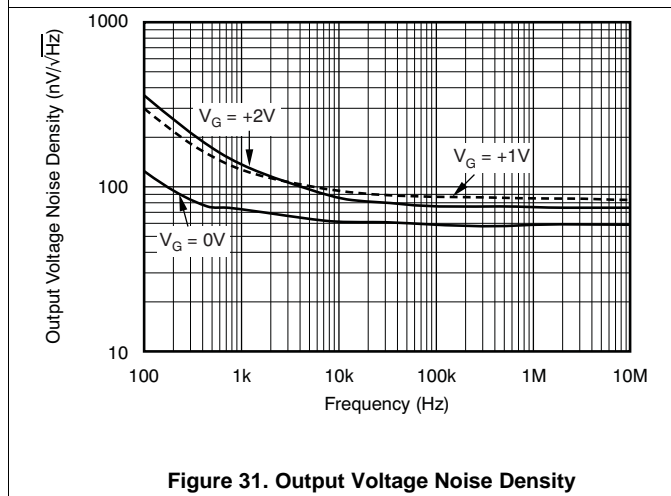

Figure 31. Output Voltage Noise Density

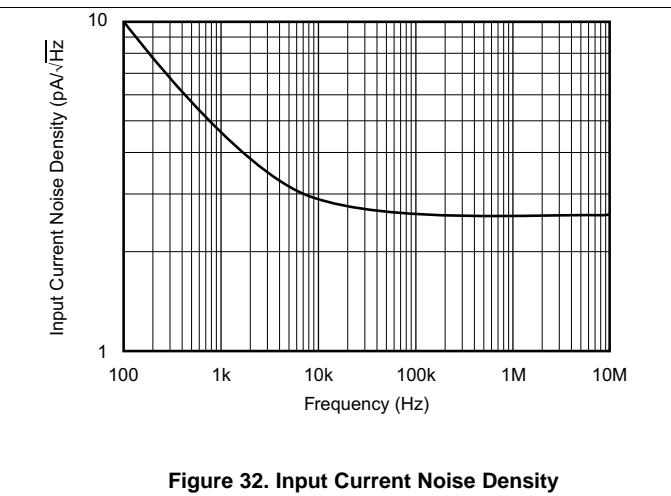
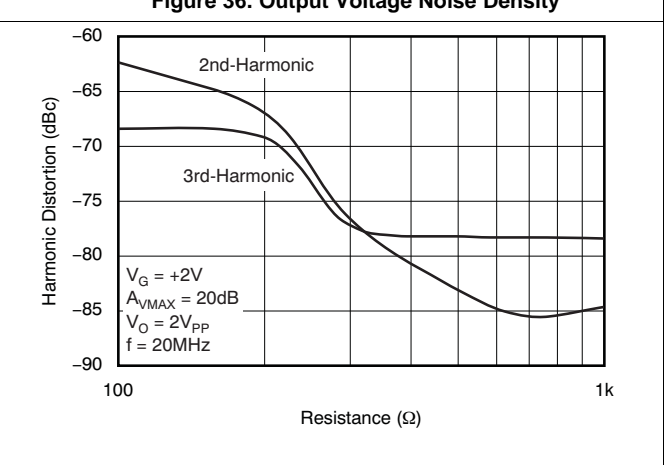
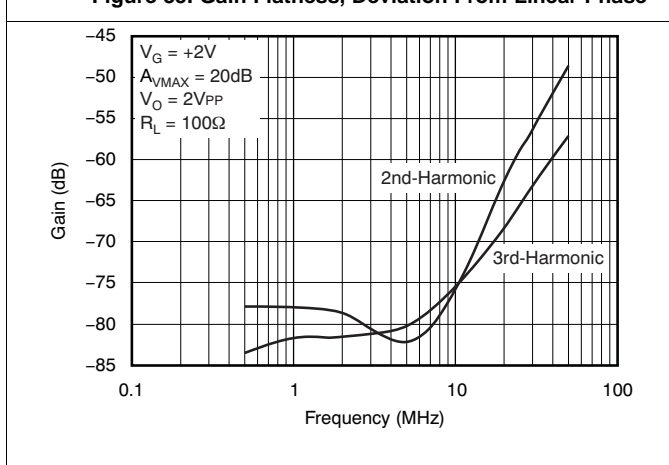
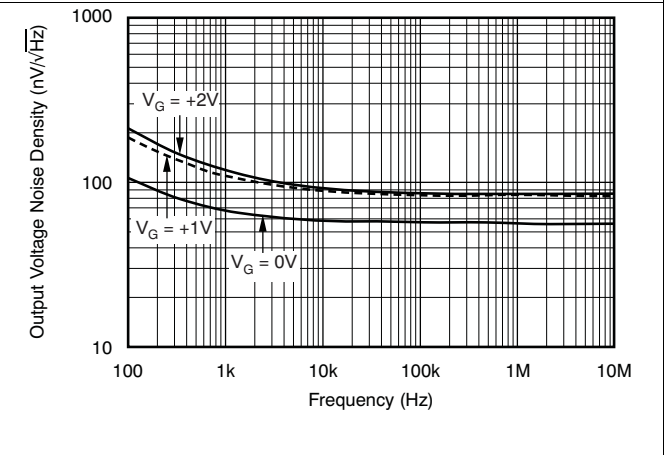
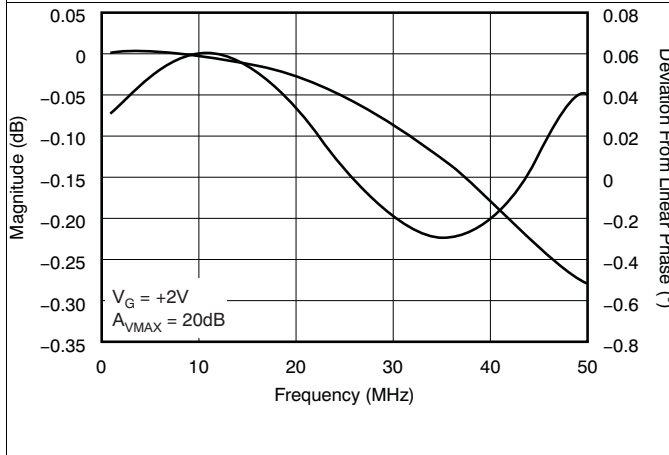
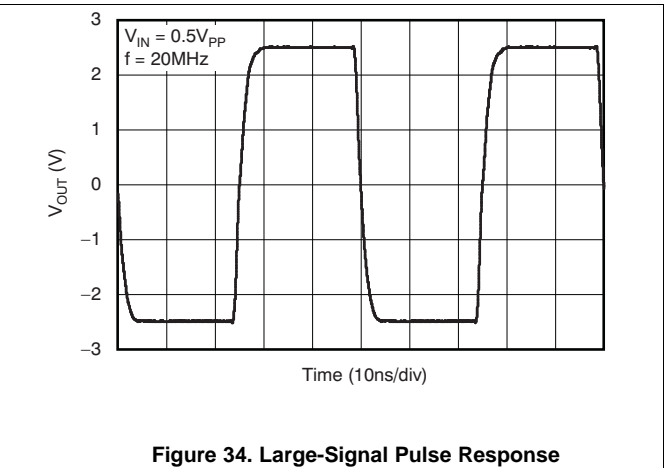
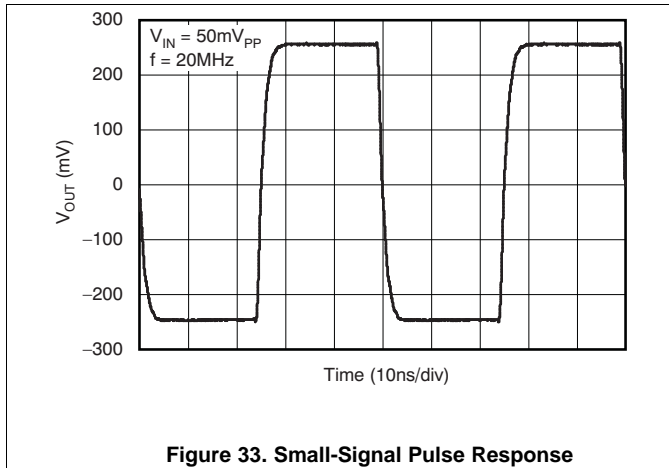

Figure 32. Input Current Noise Density

7.9 Typical Characteristics: $V_S = \pm 5\text{ V}$, $A_{VMAX} = 20\text{ dB}$

At $T_A = +25^\circ\text{C}$, $R_L = 100\ \Omega$, $R_F = 1\text{ k}\Omega$, $R_G = 200\ \Omega$, $V_G = +2\text{ V}$, and V_{IN} = single-ended input on $+V_{IN}$ with $-V_{IN}$ at ground, unless otherwise noted.



Typical Characteristics: $V_S = \pm 5\text{ V}$, $A_{VMAX} = 20\text{ dB}$ (continued)

At $T_A = +25^\circ\text{C}$, $R_L = 100\ \Omega$, $R_F = 1\text{ k}\Omega$, $R_G = 200\ \Omega$, $V_G = +2\text{ V}$, and $V_{IN} = \text{single-ended input on } +V_{IN} \text{ with } -V_{IN} \text{ at ground}$, unless otherwise noted.

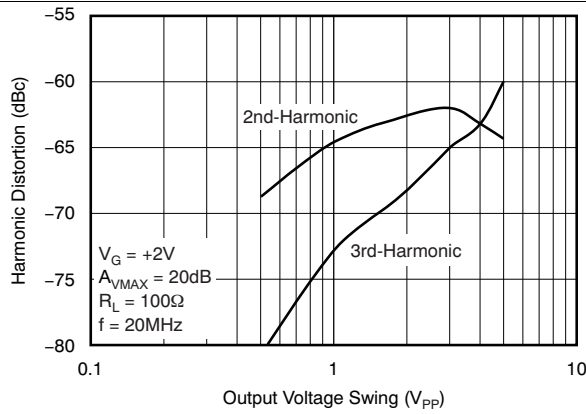

Figure 39. Harmonic Distortion vs Output Voltage

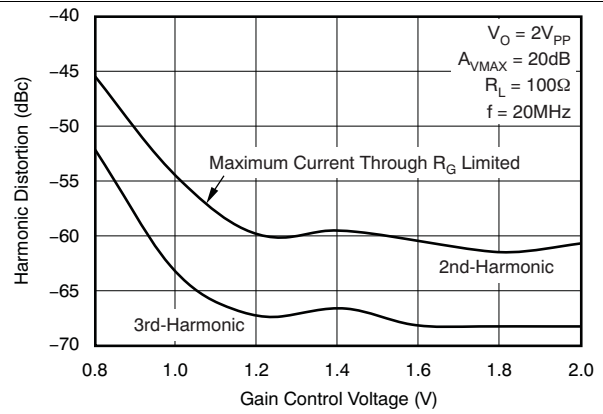

Figure 40. 20-MHz Harmonic Distortion vs Gain Control Voltage

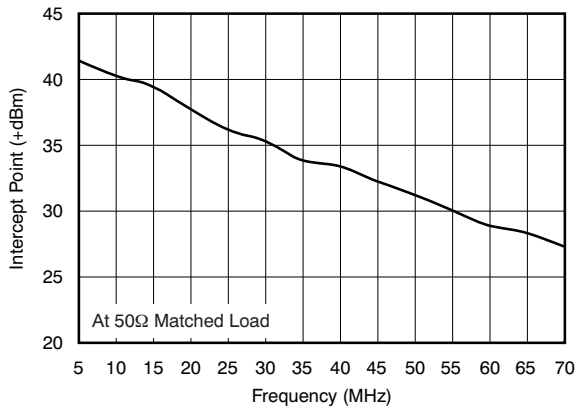

Figure 41. 2-Tone, 3rd-Order Intermodulation Intercept ($G_{MAX} = +10\text{ V/V}$)

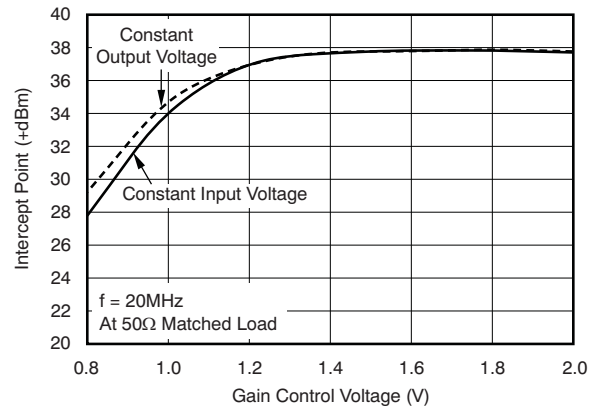

Figure 42. 2-Tone, 3rd-Order Intermodulation Intercept vs Gain Control Voltage ($f_{IN} = 20\text{ MHz}$)

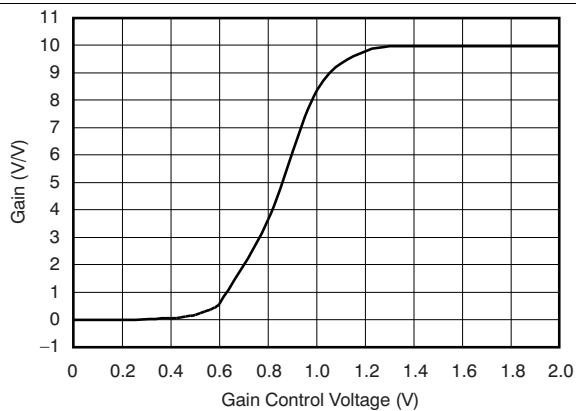

Figure 43. Gain vs Gain Control Voltage

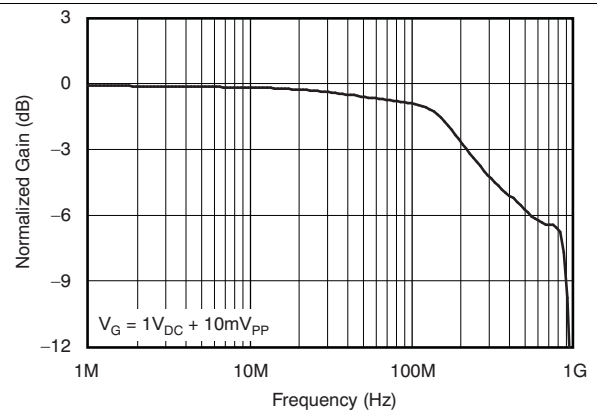

Figure 44. Gain Control Frequency Response

Typical Characteristics: $V_S = \pm 5\text{ V}$, $A_{VMAX} = 20\text{ dB}$ (continued)

At $T_A = +25^\circ\text{C}$, $R_L = 100\ \Omega$, $R_F = 1\text{ k}\Omega$, $R_G = 200\ \Omega$, $V_G = +2\text{ V}$, and $V_{IN} =$ single-ended input on $+V_{IN}$ with $-V_{IN}$ at ground, unless otherwise noted.

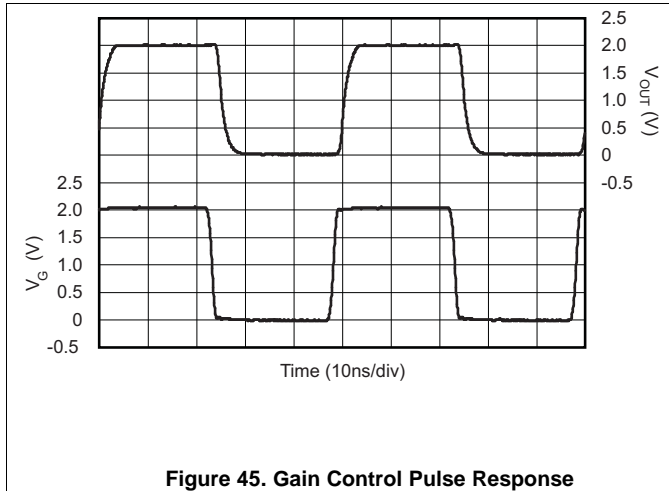

Figure 45. Gain Control Pulse Response

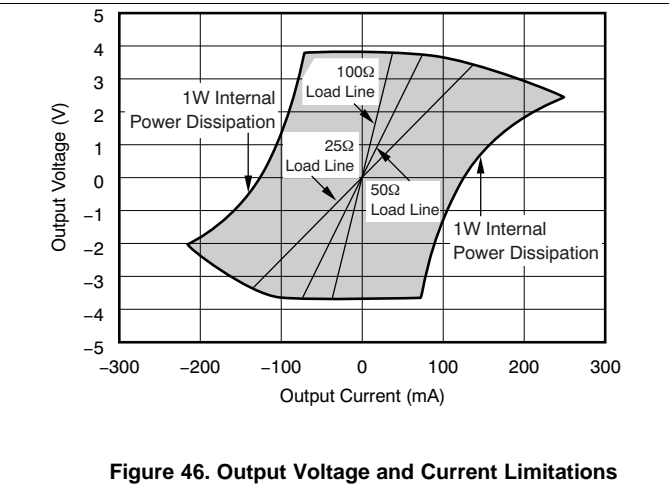

Figure 46. Output Voltage and Current Limitations

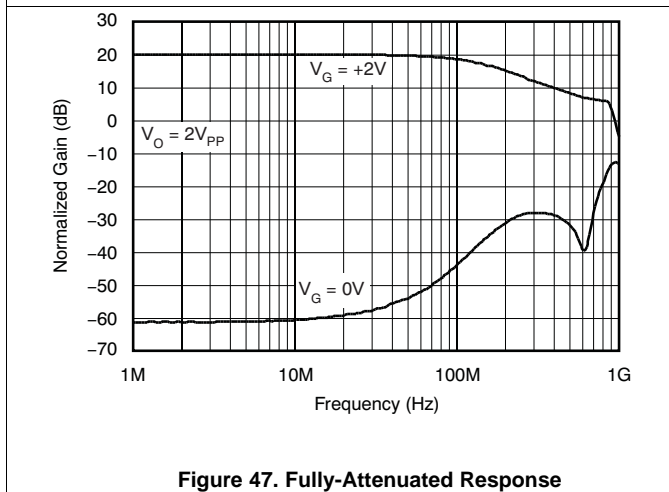

Figure 47. Fully-Attenuated Response

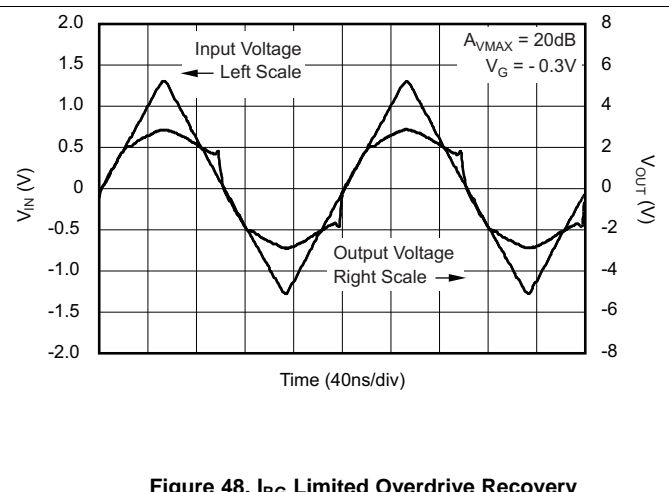

Figure 48. I_{RG} Limited Overdrive Recovery

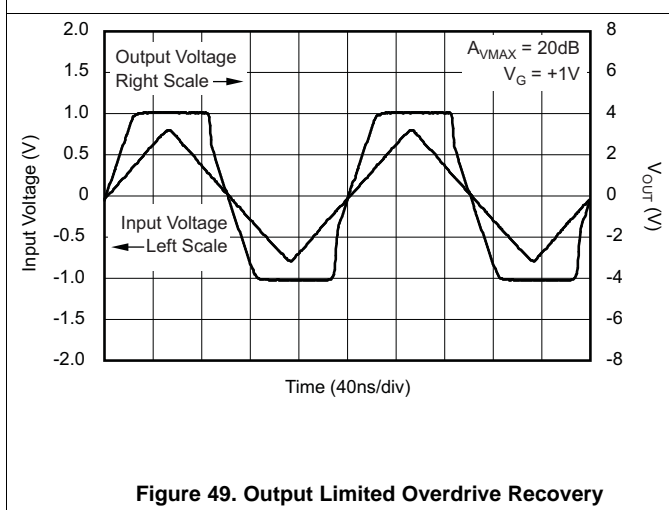

Figure 49. Output Limited Overdrive Recovery

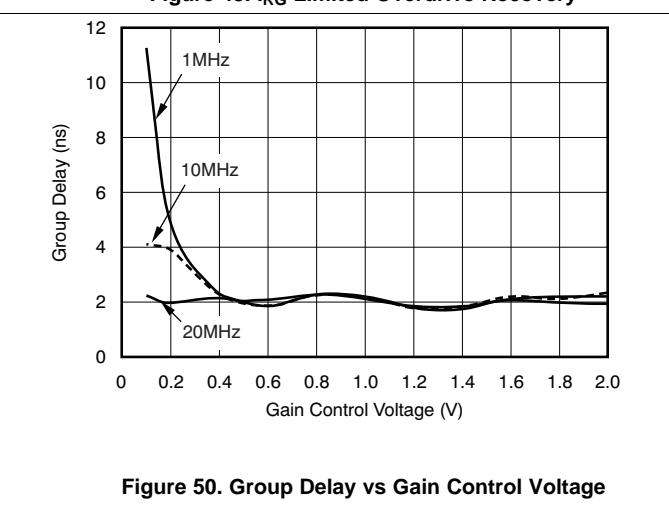

Figure 50. Group Delay vs Gain Control Voltage

Typical Characteristics: $V_S = \pm 5\text{ V}$, $A_{V_{MAX}} = 20\text{ dB}$ (continued)

At $T_A = +25^\circ\text{C}$, $R_L = 100\ \Omega$, $R_F = 1\text{ k}\Omega$, $R_G = 200\ \Omega$, $V_G = +2\text{ V}$, and V_{IN} = single-ended input on $+V_{IN}$ with $-V_{IN}$ at ground, unless otherwise noted.

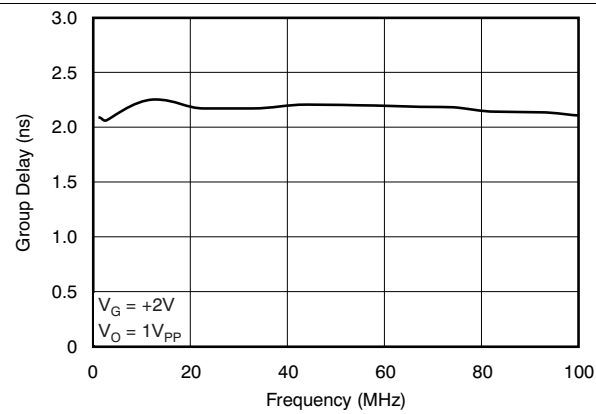

Figure 51. Group Delay vs Frequency

7.10 Typical Characteristics: $V_S = \pm 5\text{ V}$, $A_{VMAX} = 40\text{ dB}$

At $T_A = +25^\circ\text{C}$, $R_L = 100\ \Omega$, $R_F = 845\ \Omega$, $R_G = 16.9\ \Omega$, $V_G = +2\text{ V}$, V_{IN} = single-ended input on $+V_{IN}$ with $-V_{IN}$ at ground, and SO-14 package, unless otherwise noted.

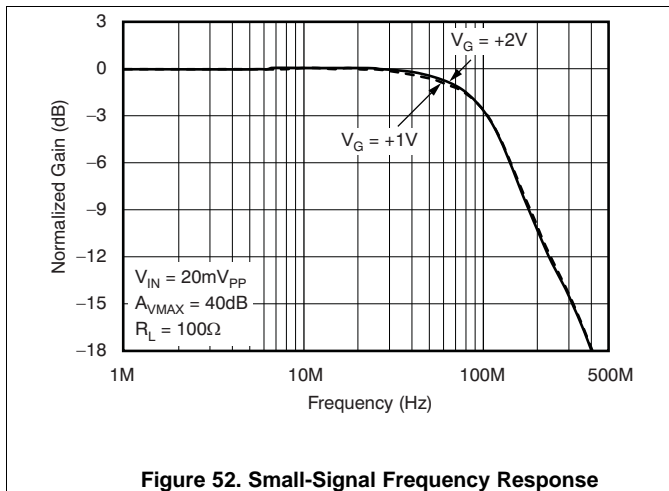

Figure 52. Small-Signal Frequency Response

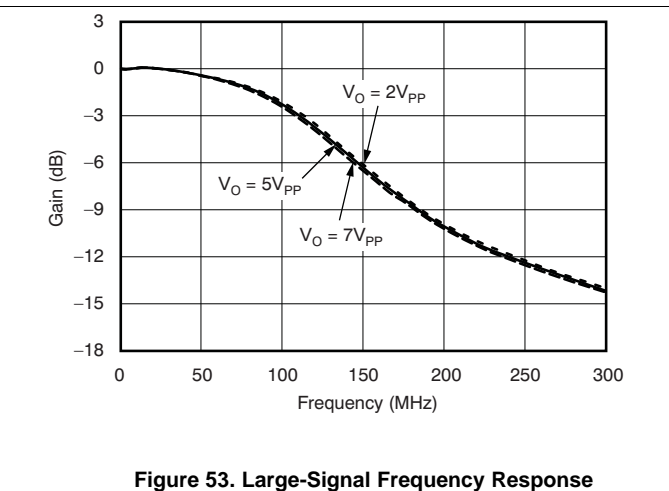

Figure 53. Large-Signal Frequency Response

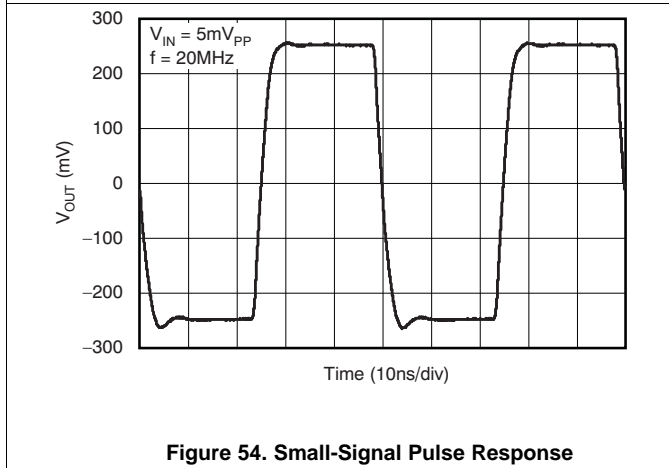

Figure 54. Small-Signal Pulse Response

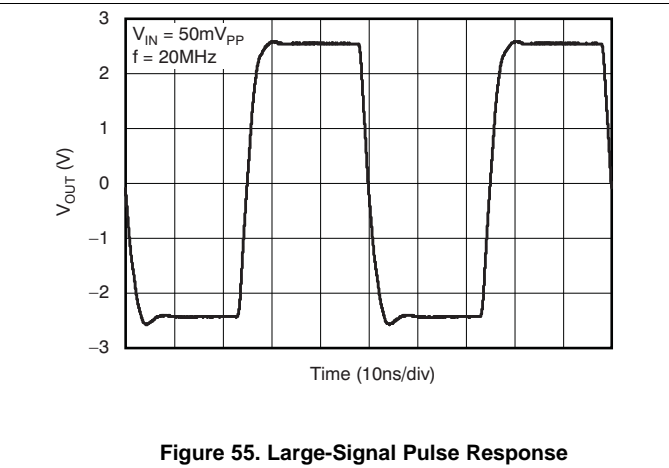

Figure 55. Large-Signal Pulse Response

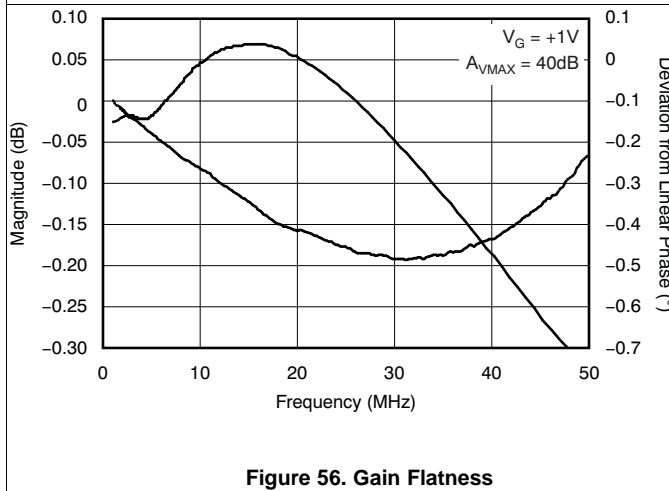

Figure 56. Gain Flatness

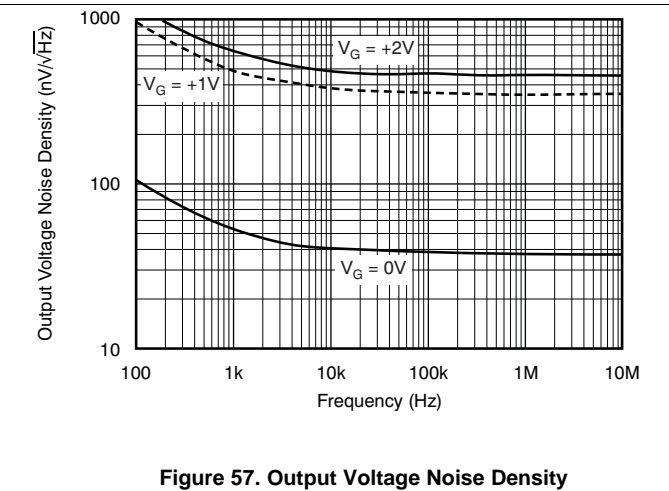

Figure 57. Output Voltage Noise Density

Typical Characteristics: $V_S = \pm 5\text{ V}$, $A_{VMAX} = 40\text{ dB}$ (continued)

At $T_A = +25^\circ\text{C}$, $R_L = 100\ \Omega$, $R_F = 845\ \Omega$, $R_G = 16.9\ \Omega$, $V_G = +2\text{ V}$, V_{IN} = single-ended input on $+V_{IN}$ with $-V_{IN}$ at ground, and SO-14 package, unless otherwise noted.

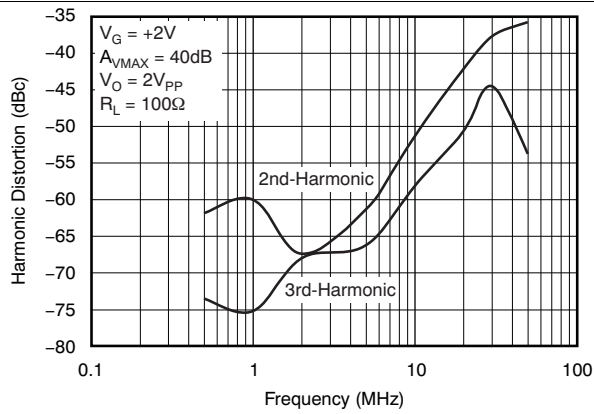

Figure 58. Harmonic Distortion vs Frequency

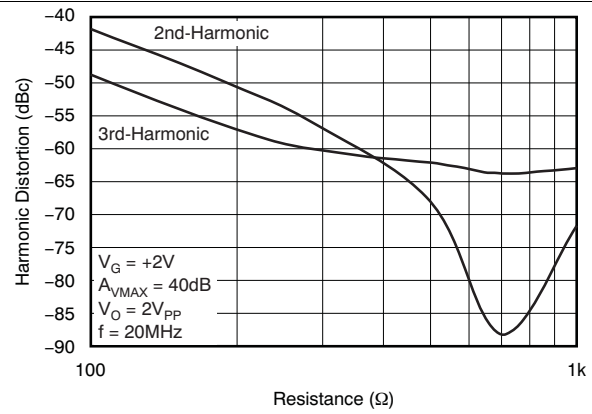

Figure 59. Harmonic Distortion vs Load Resistance

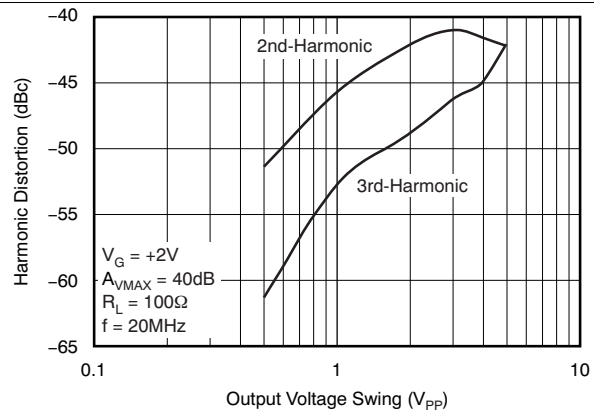

Figure 60. Harmonic Distortion vs Output Voltage

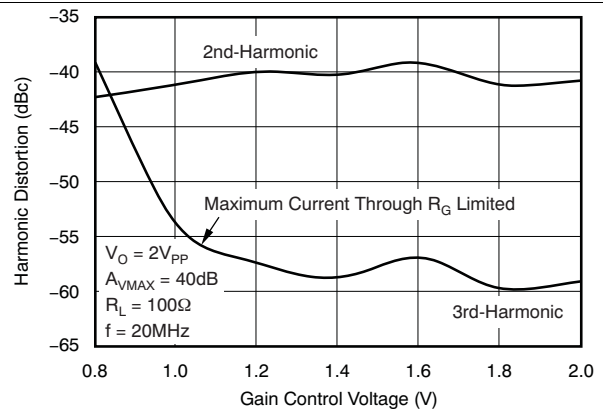

Figure 61. 20-MHz Harmonic Distortion vs Gain Control Voltage

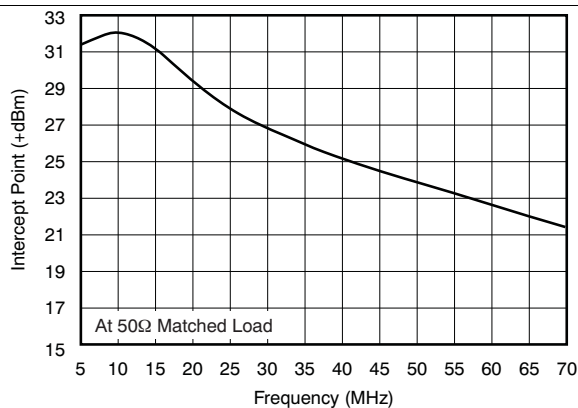

Figure 62. 2-Tone, 3rd-Order Intermodulation Intercept

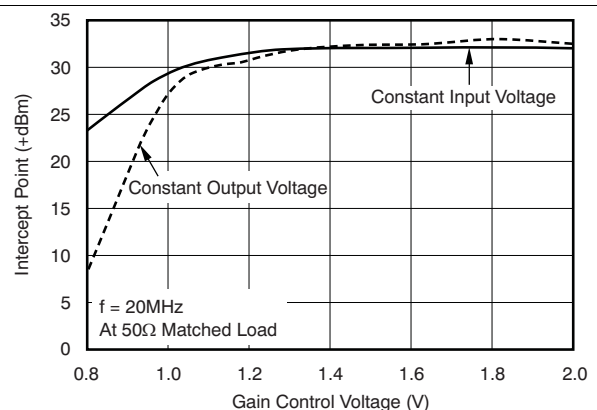

Figure 63. 2-Tone, 3rd-Order Intermodulation Intercept vs Gain Control Voltage ($f_{IN} = 20\text{ MHz}$)

Typical Characteristics: $V_S = \pm 5\text{ V}$, $A_{VMAX} = 40\text{ dB}$ (continued)

At $T_A = +25^\circ\text{C}$, $R_L = 100\ \Omega$, $R_F = 845\ \Omega$, $R_G = 16.9\ \Omega$, $V_G = +2\text{ V}$, V_{IN} = single-ended input on $+V_{IN}$ with $-V_{IN}$ at ground, and SO-14 package, unless otherwise noted.

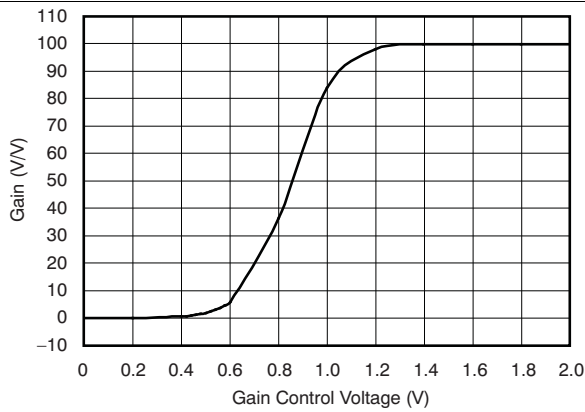

Figure 64. Gain vs Gain Control Voltage

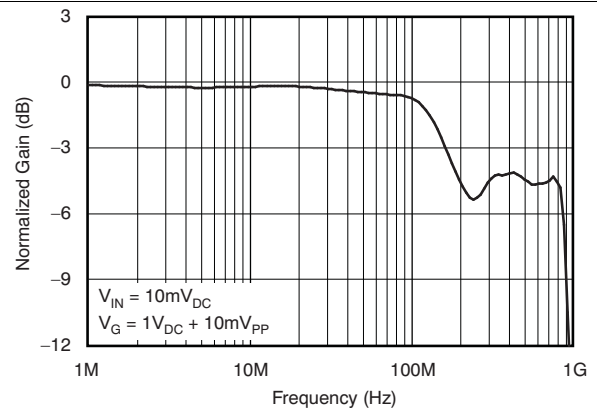

Figure 65. Gain Control Frequency

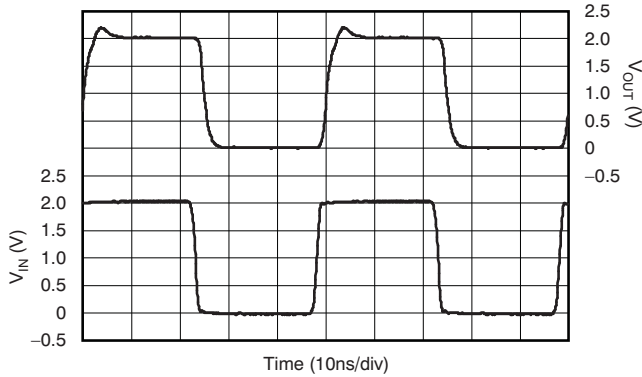

Figure 66. Gain Control Pulse Response

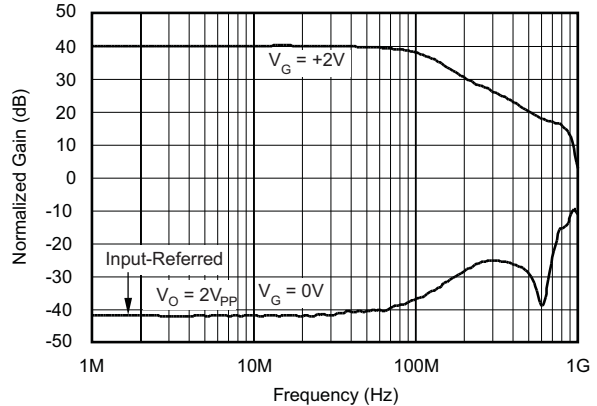

Figure 67. Fully-Attenuated Response

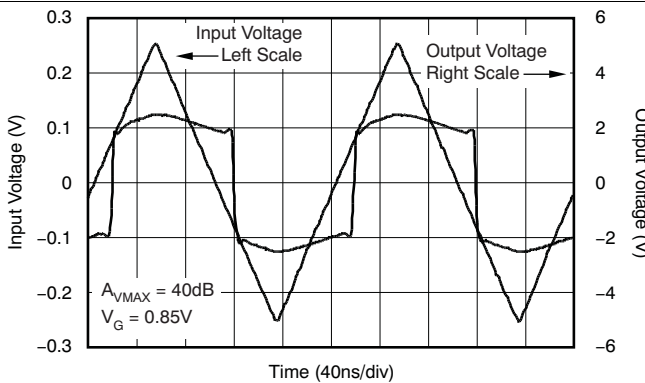

Figure 68. Input Limited Overdrive Recovery

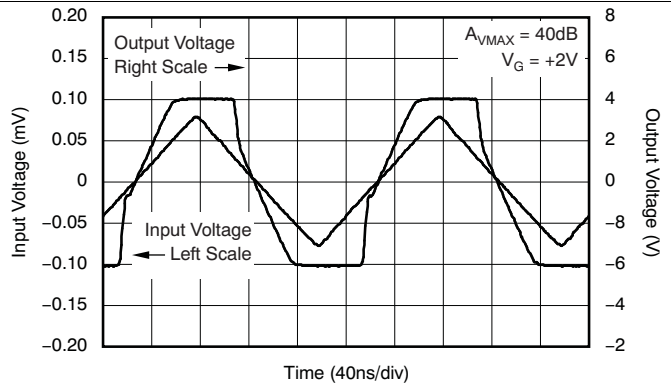

Figure 69. Output Limited Overdrive Recovery

Typical Characteristics: $V_S = \pm 5\text{ V}$, $A_{VMAX} = 40\text{ dB}$ (continued)

At $T_A = +25^\circ\text{C}$, $R_L = 100\ \Omega$, $R_F = 845\ \Omega$, $R_G = 16.9\ \Omega$, $V_G = +2\text{ V}$, V_{IN} = single-ended input on $+V_{IN}$ with $-V_{IN}$ at ground, and SO-14 package, unless otherwise noted.

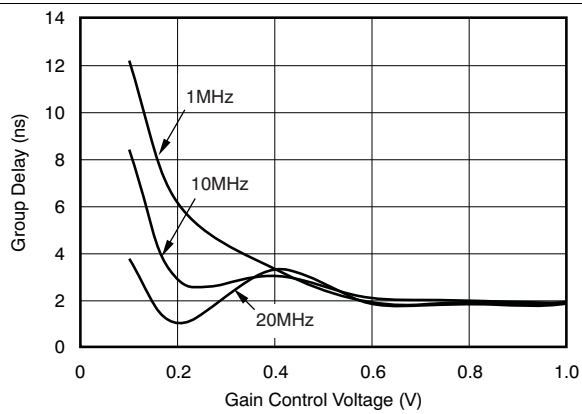

Figure 70. Group Delay vs Gain Control Voltage

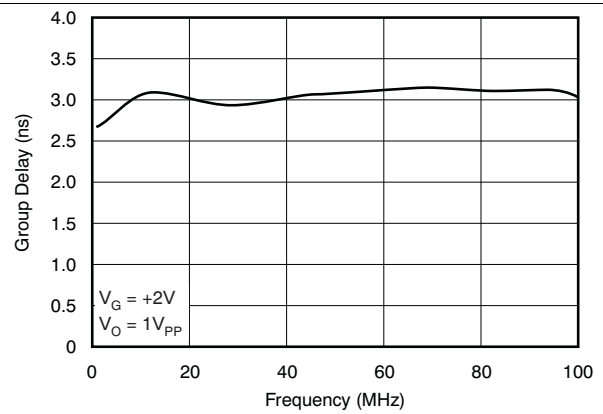

Figure 71. Group Delay vs Frequency

8 Detailed Description

8.1 Overview

The VCA820 is a voltage controlled variable gain amplifier with differential inputs and a single ended output. The maximum gain is set by external resistors while the gain range is controlled by an external analog voltage. The maximum gain is designed for gains of 2 V/V up to 100 V/V and the analog control allows a gain range of over 40 dB. The VCA820 Input consists of two buffers which, together create a fully symmetrical, high impedance differential input with a typical common mode rejection of 80 dB. The gain set resistor is connected between the two input buffer output pins, so that the input impedance is independent of the gain settings. The bipolar inputs have a input voltage range of +1.6 and -2.1 V on ± 5 -V supplies. The amplifier maximum gain is set by external resistors, but the internal gain control circuit is controlled by a continuously variable, analog voltage. The gain control is a multiplier stage which is linear in dB. The gain control input pin operates over a voltage range of 0 V to 2 V. The VCA820 contains a high-speed, high-current output buffer. The output stage can typically swing ± 3.9 V and source and sink ± 160 mA. The VCA820 can be operated over a voltage range of ± 3.5 V to ± 6 V.

8.2 Functional Block Diagram

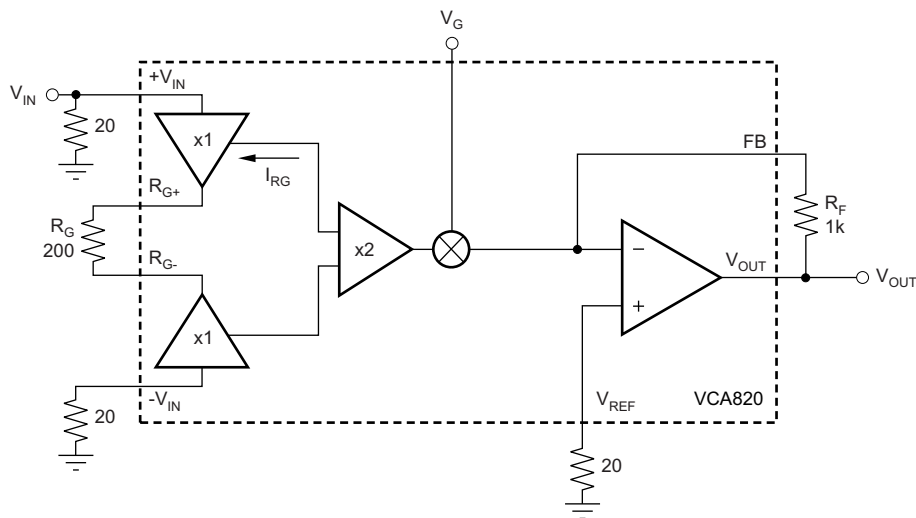

8.3 Feature Description

The VCA820 can be operated with both single ended or differential input signals. The inputs present consistently high impedance across all gain configurations. By using an analog control signal the amplifier gain is continuously variable for smooth, glitch-free gain changes. With a large signal bandwidth of 137 MHz and a slew rate of 1700 V/ μ s the VCA820 offers linear performance over a wide range of signal amplitudes and gain settings. The low-impedance/high-current output buffer can drive loads ranging from low impedance transmission lines to high-impedance, switched-capacitor analog to digital converters. By using closely matched internal components the VCA820 offers gain accuracy of ± 0.4 dB.

8.4 Device Functional Modes

The VCA820 functions as a differential input, single-ended output variable gain amplifier. This functional mode is enabled by applying power to the amplifier supply pins and is disabled by turning the power off.

The gain is continuously variable through the analog gain control input. While the gain range is fixed the maximum gain is set by two external components, R_f and R_g as shown in the [Functional Block Diagram](#). The maximum gain is equal to $2x (R_f / R_g)$. This gain is achieved with a 2-V voltage on the gain adjust pin VG. As the voltage decreases on the VG pin, the gain decreases in a linear in dB fashion with over 40 dB of gain range from 2-V to 0-V control voltage.

As with most other differential input amplifiers, inputs can be applied to either one or both of the amplifier inputs. The amplifier gain is controlled through the gain control pin.

8.4.1 Maximum Gain of Operation

This section describes the use of the VCA820 in a fixed-gain application in which the V_G control pin is set at $V_G = +2$ V. The tradeoffs described here are with bandwidth, gain, and output voltage range.

In the case of an application that does not make use of the V_{GAIN} , but requires some other characteristic of the VCA820, the R_G resistor must be set such that the maximum current flowing through the resistance I_{RG} is less than ± 2.6 -mA typical, or 5.2 mA_{PP} as defined in the [Electrical Characteristics: \$V_S = \pm 5\$ V](#) table, and must follow [Equation 1](#).

$$I_{RG} = \frac{V_{OUT}}{A_{VMAX} \times R_G} \quad (1)$$

As illustrated in [Equation 1](#), once the output dynamic range and maximum gain are defined, the gain resistor is set. This gain setting in turn affects the bandwidth, because in order to achieve the gain (and with a set gain element), the feedback element of the output stage amplifier is set as well. Keeping in mind that the output amplifier of the VCA820 is a current-feedback amplifier, the larger the feedback element, the lower the bandwidth as the feedback resistor is the compensation element.

Limiting the discussion to the input voltage only and ignoring the output voltage and gain, [Figure 1](#) illustrates the tradeoff between the input voltage and the current flowing through the gain resistor.

8.4.2 Output Current and Voltage

The VCA820 provides output voltage and current capabilities that are unsurpassed in a low-cost monolithic VCA. Under no-load conditions at $+25^\circ\text{C}$, the output voltage typically swings closer than 1 V to either supply rails; the $+25^\circ\text{C}$ swing limit is within 1.2 V of either rails. Into a 15- Ω load (the minimum tested load), it is tested to deliver more than ± 160 mA.

The specifications described above, though familiar in the industry, consider voltage and current limits separately. In many applications, it is the voltage \times current, or *V-I product*, that is more relevant to circuit operation. Refer to the [Output Voltage and Current Limitations](#) plot ([Figure 46](#)) in the Typical Characteristics. The X- and Y-axes of this graph show the zero-voltage output current limit and the zero-current output voltage limit, respectively. The four quadrants give a more detailed view of the VCA820 output drive capabilities, noting that the graph is bounded by a *Safe Operating Area* of 1W maximum internal power dissipation. Superimposing resistor load lines onto the plot shows that the VCA820 can drive ± 2.5 V into 25 Ω or ± 3.5 V into 50 Ω without exceeding the output capabilities or the 1-W dissipation limit. A 100- Ω load line (the standard test circuit load) shows the full ± 3.9 -V output swing capability, as shown in the [Typical Characteristics](#).

The minimum specified output voltage and current over-temperature are set by worst-case simulations at the cold temperature extreme. Only at cold startup do the output current and voltage decrease to the numbers shown in the [Electrical Characteristics](#) tables. As the output transistors deliver power, the respective junction temperatures increase, increasing the available output voltage swing, and increasing the available output current. In steady-state operation, the available output voltage and current is always greater than that temperature shown in the over-temperature specifications because the output stage junction temperatures are higher than the specified operating ambient.

Device Functional Modes (continued)

8.4.3 Input Voltage Dynamic Range

The VCA820 has an input dynamic range limited to +1.6 V and –2.1 V. Increasing the input voltage dynamic range can be done by using an attenuator network on the input. If the VCA820 is trying to regulate the amplitude at the output, such as in an AGC application, the input voltage dynamic range is directly proportional to [Equation 2](#).

$$V_{IN(PP)} = R_G \times I_{RG(PP)} \quad (2)$$

As such, for unity-gain or under-attenuated conditions, the input voltage must be limited to the CMIR of ±1.6 V (3.2 V_{PP}) and the current (I_{RQ}) must flow through the gain resistor, ±2.6 mA (5.2 mA_{PP}). This configuration sets a minimum value for R_E such that the gain resistor has to be greater than [Equation 3](#).

$$R_{GMIN} = \frac{3.2V_{PP}}{5.2mA_{PP}} = 615.4\Omega \quad (3)$$

Values lower than 615.4Ω are gain elements that result in reduced input range, as the dynamic input range is limited by the current flowing through the gain resistor R_G (I_{RG}). If the I_{RG} current is limiting the performance of the circuit, the input stage of the VCA820 goes into overdrive, resulting in limited output voltage range. Such I_{RG}-limited overdrive conditions are shown in [Figure 48](#) for the gain of 20 dB and [Figure 68](#) for the 40-dB gain.

8.4.4 Output Voltage Dynamic Range

With its large output current capability and its wide output voltage swing of ±3.9-V typical on 100-Ω load, it is easy to forget other types of limitations that the VCA820 can encounter. For these limitations, careful analysis must be done to avoid input stage limitation, either voltage or I_{RG} current; also, consider the gain limitation, as the control pin V_G varies, affecting other aspects of the circuit.

8.4.5 Bandwidth

The output stage of the VCA820 is a wideband current-feedback amplifier. As such, the external feedback resistance is the compensation of the last stage. Reducing the feedback element and maintaining the gain constant limits the useful range of I_{RG}, and therefore reducing the gain adjust range. For a given gain, reducing the gain element limits the maximum achievable output voltage swing.

8.4.6 Offset Adjustment

As a result of the internal architecture used on the VCA820, the output offset voltage originates from the output stage and from the input stage and multiplier core. [Figure 87](#) illustrates how to compensate both sources of the output offset voltage. Use this procedure to compensate the output offset voltage: starting with the output stage compensation, set V_G = 0 V to eliminate all offset contribution of the input stage and multiplier core. Adjust the output stage offset compensation potentiometer. Finally, set V_G = +1 V to the maximum gain and adjust the input stage and multiplier core potentiometer. This procedure effectively eliminates all offset contribution at the maximum gain. Because adjusting the gain modifies the contribution of the input stage and the multiplier core, some residual output offset voltage remains.

8.4.7 Noise

The VCA820 offers 8.2-nV/√Hz input-referred voltage noise density at a gain of 20 dB and 1.8-pA/√Hz input-referred current noise density. The input-referred voltage noise density considers that all noise terms, except the input current noise on each of the two input pins but including the thermal noise of both the feedback resistor and the gain resistor, are expressed as one term.

This model is formulated in [Equation 4](#) and [Figure 86](#).

$$e_o = A_{VMAX} \times \sqrt{2 \times (R_s \times i_n)^2 + e_n^2 + 2 \times 4kTR_s} \quad (4)$$

A more complete model is illustrated in [Figure 88](#). For additional information on this model and the actual modeled noise terms, please contact the High-Speed Product Application Support team at www.ti.com.

Device Functional Modes (continued)

8.4.8 Input and ESD Protection

The VCA820 is built using a very high-speed complementary bipolar process. The internal junction breakdown voltages are relatively low for these very small geometry devices. These breakdowns are reflected in the table.

All pins on the VCA820 are internally protected from ESD by means of a pair of back-to-back reverse-biased diodes to either power supply, as shown in [Figure 72](#). These diodes begin to conduct when the pin voltage exceeds either power supply by approximately 0.7 V. This situation can occur with loss of the amplifier power supplies while a signal source is still present. The diodes can typically withstand a continuous current of 30 mA without destruction. To ensure long-term reliability, however, diode current should be externally limited to 10 mA whenever possible.

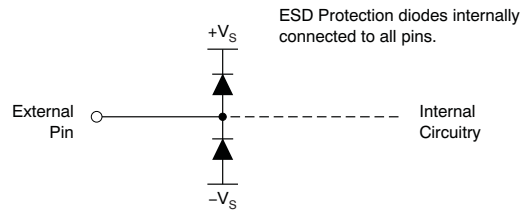

Figure 72. Internal ESD Protection

9 Application and Implementation

NOTE

Information in the following applications sections is not part of the TI component specification, and TI does not warrant its accuracy or completeness. TI's customers are responsible for determining suitability of components for their purposes. Customers should validate and test their design implementation to confirm system functionality.

9.1 Application Information

The VCA820 has flexible maximum gain which is set by the Rf and Rg resistors shown in [Functional Block Diagram](#). The maximum gain is equal to $2x (R_f / R_g)$. This gain is achieved with a 2-V voltage on the gain adjust pin VG. As the voltage decreases on the VG pin, the gain decreases in a linear in dB fashion with over 40 dB of gain range from 2-V to 0-V control voltage.

9.1.1 Design-In Tools

9.1.1.1 Demonstration Boards

Two printed circuit boards (PCBs) are available to assist in the initial evaluation of circuit performance using the VCA820 in its two package options. Both of these are offered free of charge as unpopulated PCBs, delivered with a user's guide. The summary information for these fixtures is shown in [Table 2](#).

Table 2. EVM Ordering Information

PRODUCT	PACKAGE	BOARD PART NUMBER	LITERATURE REQUEST NUMBER
VCA820ID	SO-14	DEM-VCA-SO-1B	SBOU050
VCA820IDGS	MSOP-10	DEM-VCA-MSOP-1A	SBOU051

The demonstration fixtures can be requested at the Texas Instruments web site (www.ti.com) through the VCA820 product folder.

9.1.1.2 Macromodels and Applications Support

Computer simulation of circuit performance using SPICE is often useful when analyzing the performance of analog circuits and systems. This principle is particularly true for video and RF amplifier circuits where parasitic capacitance and inductance can play a major role in circuit performance. A [SPICE model](#) for the VCA820 is available through the TI web page. The applications group is also available for design assistance. The models available from TI predict typical small-signal ac performance, transient steps, dc performance, and noise under a wide variety of operating conditions. The models include the noise terms found in the electrical specifications of the relevant product data sheet.

9.1.2 Operating Suggestions

Operating the VCA820 optimally for a specific application requires trade-offs between bandwidth, input dynamic range and the maximum input voltage, the maximum gain of operation and gain, output dynamic range and the maximum input voltage, the package used, loading, and layout and bypass recommendations. The [Typical Characteristics](#) have been defined to cover a wide range of external and operating conditions to describe the VCA820 operation. There are four sections in the Typical Characteristics:

- $V_S = \pm 5\text{ V}$ [DC Parameters](#) and $V_S = \pm 5\text{ V}$ [DC and Power-Supply Parameters](#), which include DC operation and the intrinsic limitation of a VCA820 design
- $V_S = \pm 5\text{ V}$, $A_{VMAX} = 6\text{ dB}$ [Gain of 6-dB Operation](#)
- $V_S = \pm 5\text{ V}$, $A_{VMAX} = 20\text{ dB}$ [Gain of 20-dB Operation](#)
- $V_S = \pm 5\text{ V}$, $A_{VMAX} = 40\text{ dB}$ [Gain of 40-dB Operation](#)

Where the Typical Characteristics describe the actual performance that can be achieved by using the amplifier properly, the following sections describe in detail the trade-offs needed to achieve this level of performance.

Application Information (continued)

9.1.2.1 Package Considerations

The VCA820 is available in both SO-14 and MSOP-10 packages. Each package has, for the different gains used in the typical characteristics, different values of R_F and R_G in order to achieve the same performance detailed in the *Electrical Characteristics* table.

Figure 73 shows a test gain circuit for the VCA820. Table 3 lists the recommended configuration for the SO-14 and MSOP-10 package.

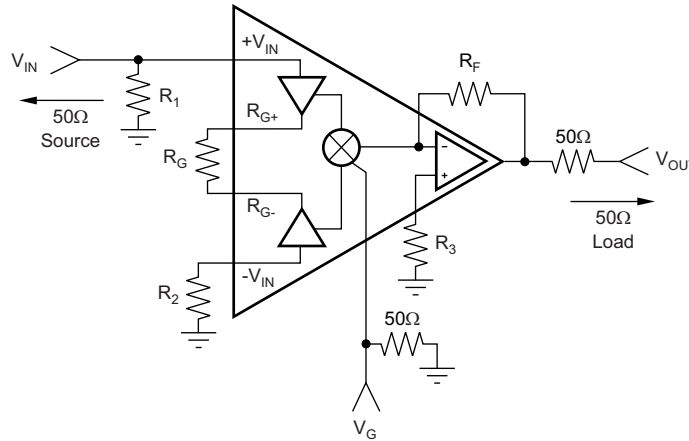
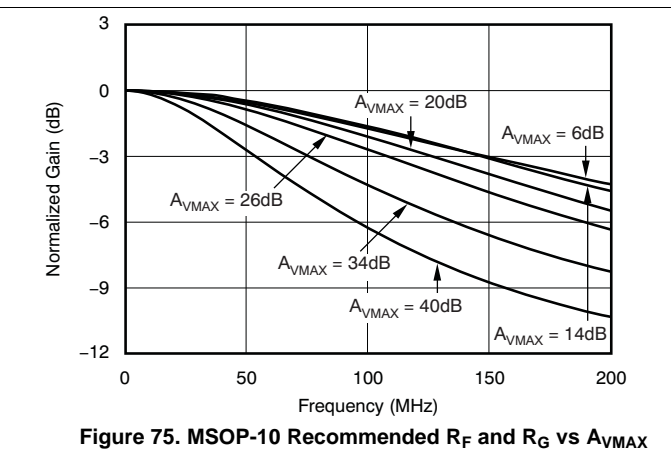
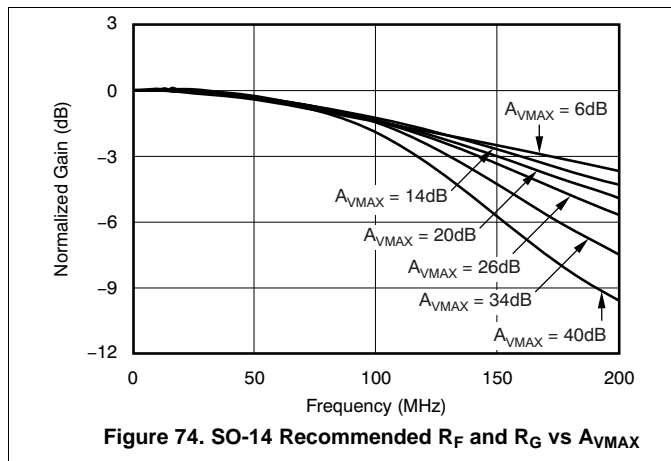

Figure 73. Test Circuit

Table 3. SO-14 and MSOP-10 R_F and R_G Configurations

	G = 2	G = 10	G = 100
R_F	1.33 kΩ	1 kΩ	845 Ω
R_G	1.33 kΩ	200 Ω	16.9 Ω

There are no differences between the packages in the recommended values for the gain and feedback resistors. However, the bandwidth for the VCA820IDGS (MSOP-10 package) is lower than the bandwidth for the VCA820ID (SO-14 package). This difference is true for all gains, but especially true for gains greater than 5 V/V, as can be seen in Figure 74 and Figure 75. The scale must be changed to a linear scale to view the details.



9.2 Typical Applications

9.2.1 Wideband Variable Gain Amplifier Operation

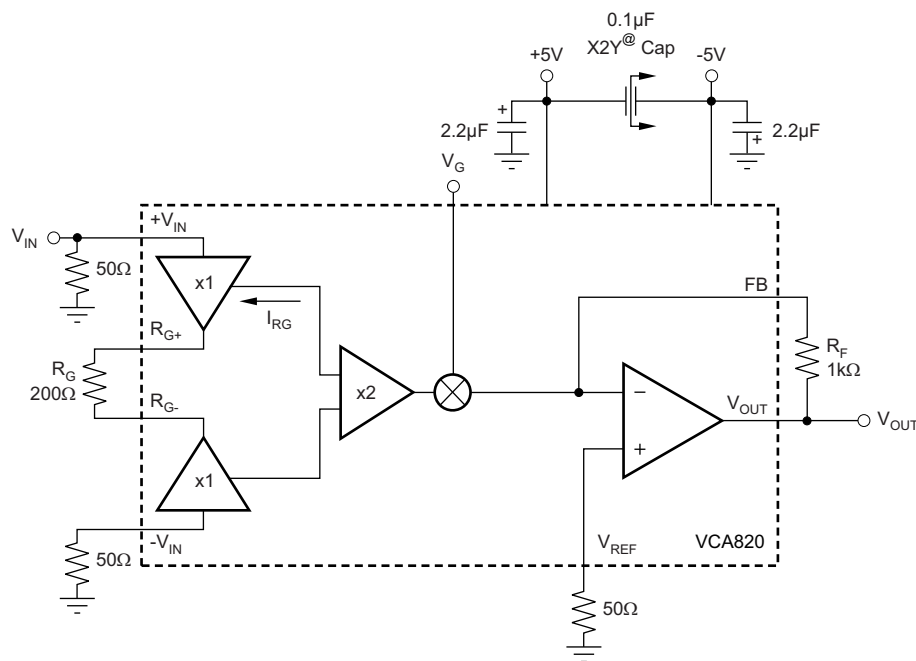

Figure 76. DC-Coupled, $A_{V_{MAX}} = 20$ dB, Bipolar Supply Specification and Test Circuit

9.2.1.1 Design Requirements

The design shown in Figure 76 supports a single-ended input, continuously variable gain control and a single-ended output. This configuration is used to achieve the best performance with a bipolar supply. This circuit also requires a maximum gain of 10 V/V and low noise.

9.2.1.2 Detailed Design Procedure

The VCA820 provides an exceptional combination of high output power capability with a wideband, greater than 40-dB gain adjust range, linear in dB variable gain amplifier. The VCA820 input stage places the transconductance element between two input buffers, using the output currents as the forward signal. As the differential input voltage rises, a signal current is generated through the gain element. This current is then mirrored and gained by a factor of two before reaching the multiplier. The other input of the multiplier is the voltage gain control pin, V_G . Depending on the voltage present on V_G , up to two times the gain current is provided to the transimpedance output stage. The transimpedance output stage is a current-feedback amplifier providing high output current capability and high slew rate, 1700 V/ μ s. This exceptional full-power performance comes at the price of a relatively high quiescent current (34mA), but a low input voltage noise for this type of architecture (8.2 nV/ $\sqrt{\text{Hz}}$).

Figure 76 shows the dc-coupled, gain of 20 dB, dual power-supply circuit used as the basis of the ± 5 V and . For test purposes, the input impedance is set to 50 Ω with a resistor to ground and the output impedance is set to 50 Ω with a series output resistor. Voltage swings reported in the table are taken directly at the input and output pins, while output power (dBm) is at the matched 50- Ω load. For the circuit in Figure 76, the total effective load is 100 Ω || 1 k Ω . Note that for the SO-14 package, there is a voltage reference pin, V_{REF} (pin 9). For the SO-14 package, this pin must be connected to ground through a 20- Ω resistor in order to avoid possible oscillations of the output stage. In the MSOP-10 package, this pin is internally connected to ground and does not require such precaution. An X2Y[®] capacitor has been used for power-supply bypassing. The combination of low inductance, high resonance frequency, and integration of three capacitors in one package (two capacitors to ground and one across the supplies) of this capacitor contributes to the low second-harmonic distortion reported in the [Electrical Characteristics](#) table. More information on how the VCA820 operates can be found in the section.

VCA820

SBOS395D – OCTOBER 2007 – REVISED SEPTEMBER 2015

www.ti.com

9.2.1.3 Application Curves

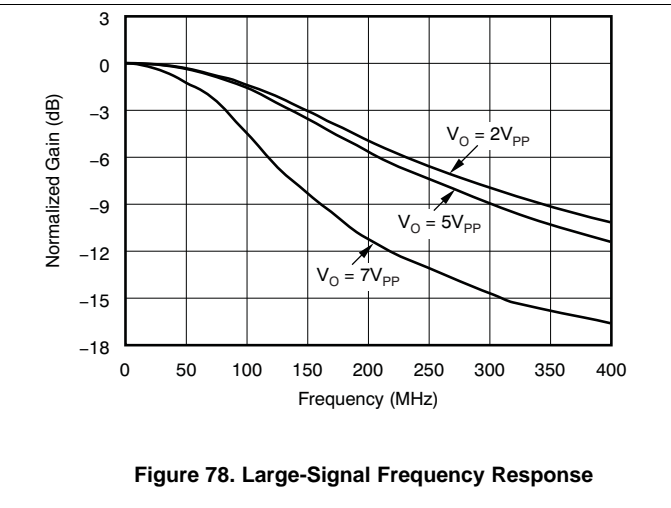
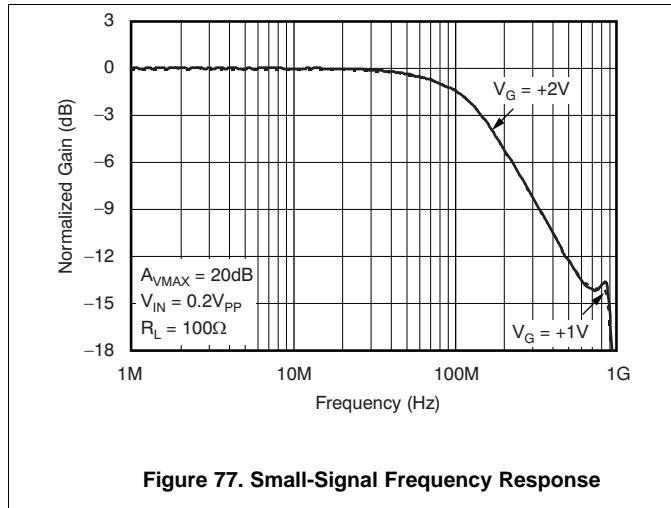

9.2.2 Difference Amplifier

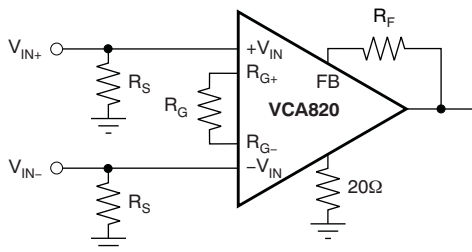

Figure 79. Wideband Differential to Single-Ended Amplifier

9.2.2.1 Design Requirements

For a difference amplifier, the design requirements are differential voltage gain, common mode rejection, and load drive capability. This circuit delivers differential gain of $2 \cdot (R_f/R_g)$, and CMRR as shown in Figure 80.

9.2.2.2 Detailed Design Procedure

Because both inputs of the VCA820 are high-impedance, a difference amplifier can be implemented without any major problem. This implementation is shown in Figure 79. This circuit provides excellent common-mode rejection ratio (CMRR) as long as the input is within the CMRR range of -2.1 V to $+1.6$ V. Note that this circuit does not make use of the gain control pin, V_G . Also, it is recommended to choose R_S such that the pole formed by R_S and the parasitic input capacitance does not limit the bandwidth of the circuit. The common-mode rejection ratio for this circuit implemented in a gain of 20 dB for $V_G = +2$ V is shown in Figure 80. Note that because the gain control voltage is fixed and is normally set to $+2$ V, the feedback element can be reduced in order to increase the bandwidth. When reducing the feedback element make sure that the VCA820 is not limited by common-mode input voltage, the current flowing through R_G , or any other limitation described in this data sheet.

9.2.2.3 Application Curve

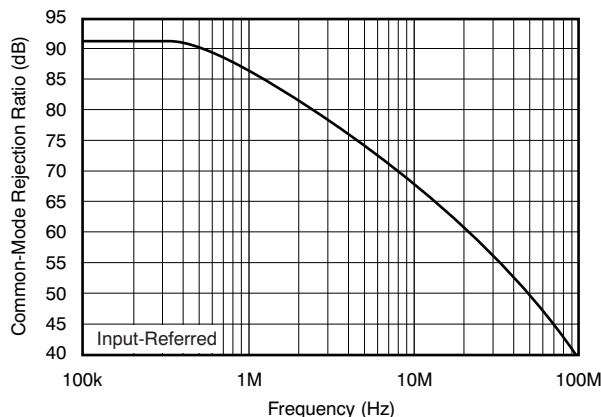

Figure 80. Common-Mode Rejection Ratio

9.2.3 Differential Equalizer

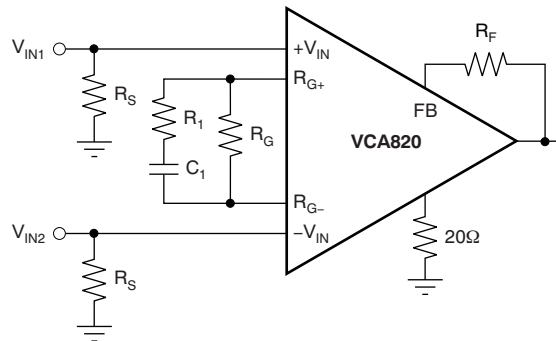

Figure 81. Differential Equalizer

9.2.3.1 Design Requirements

Signals that travel over a length of cable experience an attenuation that is proportional to the square root of the frequency. For this reason, a flat response amplifier will not restore the original signal. To replicate the original signal, the higher frequency signal components require more gain. The circuit in Figure 81 has one stage of frequency shaping to help restore a signal transmitted along a cable. If needed, additional frequency shaping stages can be added as shown in Figure 82.

9.2.3.2 Detailed Design Procedure

If the application requires frequency shaping (the transition from one gain to another), the VCA820 can be used advantageously because its architecture allows the application to isolate the input from the gain setting elements. Figure 81 shows an implementation of such a configuration. The transfer function is shown in Equation 5.

$$G = 2 \times \frac{R_F}{R_G} \times \frac{1 + sR_G C_1}{1 + sR_1 C_1} \tag{5}$$

This transfer function has one pole, P_1 (located at $R_G C_1$), and one zero, Z_1 (located at $R_1 C_1$). When equalizing an RC load, R_L and C_L , compensate the pole added by the load located at $R_L C_L$ with the zero Z_1 . Knowing R_L , C_L , and R_G allows the user to select C_1 as a first step and then calculate R_1 . Using $R_L = 75 \Omega$, $C_L = 100 \text{ pF}$ and wanting the VCA820 to operate at a gain of +2 V/V, which gives $R_F = R_G = 1.33 \text{ k}\Omega$, allows the user to select $C_1 = 5 \text{ pF}$ to ensure a positive value for the resistor R_1 . With all these values known, R_1 can be calculated to be 170 Ω . The frequency response for both the initial, unequalized frequency response and the resulting equalized frequency response are illustrated in Figure 82.

9.2.3.3 Application Curve

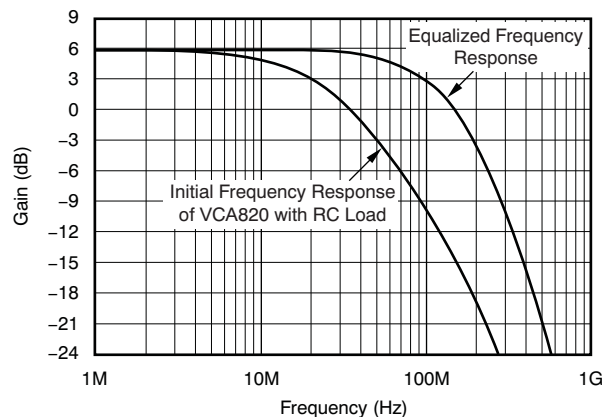

Figure 82. Differential Equalization of an RC Load

9.2.4 Differential Cable Equalizer

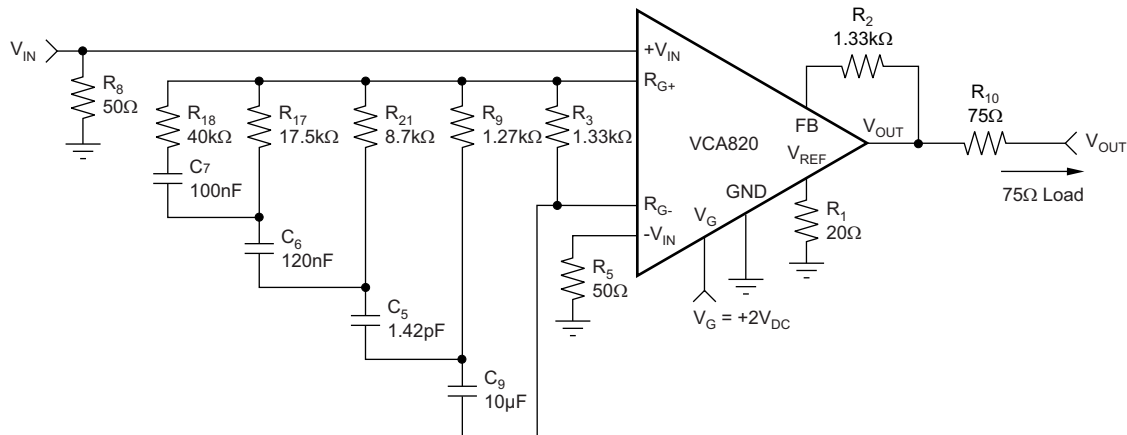

Figure 83. Differential Cable Equalizer

9.2.4.1 Design Requirements

Signals that travel over a length of cable experience an attenuation that is proportional to the square root of the frequency. For this reason, a fixed bandwidth amplifier will not restore the original signal. To replicate the original signal, the higher frequency signal components require more gain. The circuit in Figure 83 has multiple stages of frequency shaping to help restore a signal transmitted along a cable. This circuit is similar to the one shown in Figure 81, but is much more accurate in replicating the $1/\sqrt{f}$ frequency response shape.

9.2.4.2 Detailed Design Procedure

A differential cable equalizer can easily be implemented using the VCA820. An example of a cable equalization for 100 feet of Belden Cable 1694F is illustrated in Figure 83, with the result for this implementation shown in Figure 84. This implementation has a maximum error of 0.2 dB from dc to 40 MHz.

Note that this implementation shows the cable attenuation side-by-side with the equalization in the same plot. For a given frequency, the equalization function realized with the VCA820 matches the cable attenuation. The circuit in Figure 83 is a driver circuit. To implement a receiver circuit, the signal is received differentially between the $+V_{IN}$ and $-V_{IN}$ inputs.

For a detailed design procedure, refer to SBOA124.

9.2.4.3 Application Curve

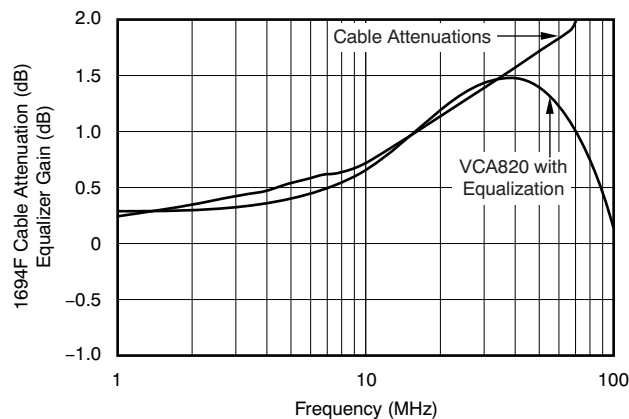

Figure 84. Cable Attenuation versus Equalizer Gain

9.2.5 AGC Loop

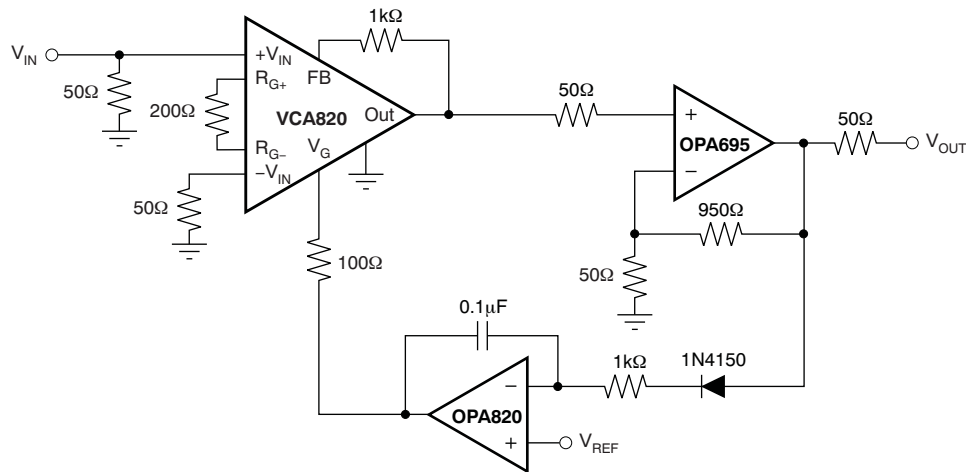

Figure 85. AGC Loop

9.2.5.1 Design Requirements

When dynamic signal amplitude correction is required, an AGC loop will provide real-time gain control. The requirements for this circuit are fast gain control response and linear in dB gain control. The time constant of the loop is set with the 0.1- μ F capacitor and the 1-k Ω resistor. The OPA695 provides additional load driving capability.

9.2.5.2 Detailed Design Procedure

In the typical AGC loop shown in [Figure 85](#), the OPA695 follows the VCA820 to provide 40 dB of overall gain. The output of the OPA695 is rectified and integrated by an OPA820 to control the gain of the VCA820. When the output level exceeds the reference voltage (V_{REF}), the integrator ramps down reducing the gain of the AGC loop. Conversely, if the output is too small, the integrator ramps up increasing the net gain and the output voltage.

9.3 System Examples

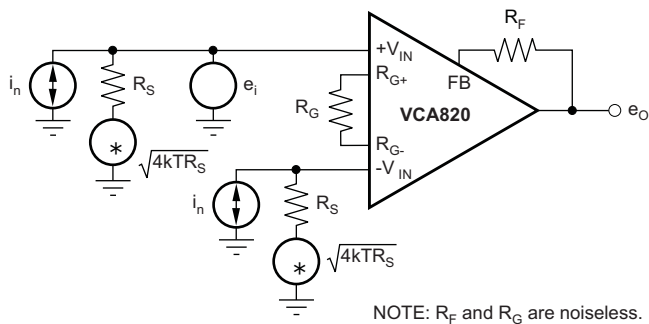

Figure 86. Simple Noise Model

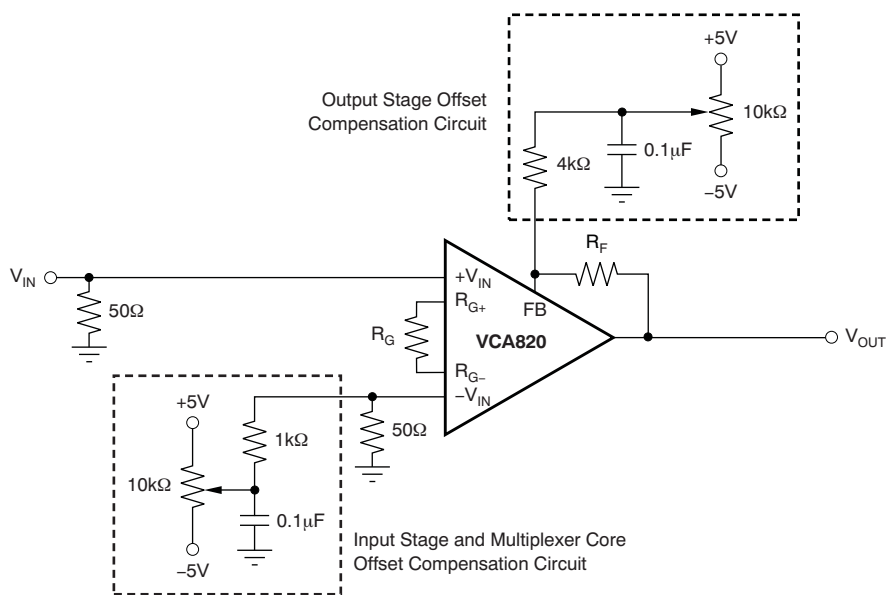

Figure 87. Adjusting the Input and Output Voltage Sources

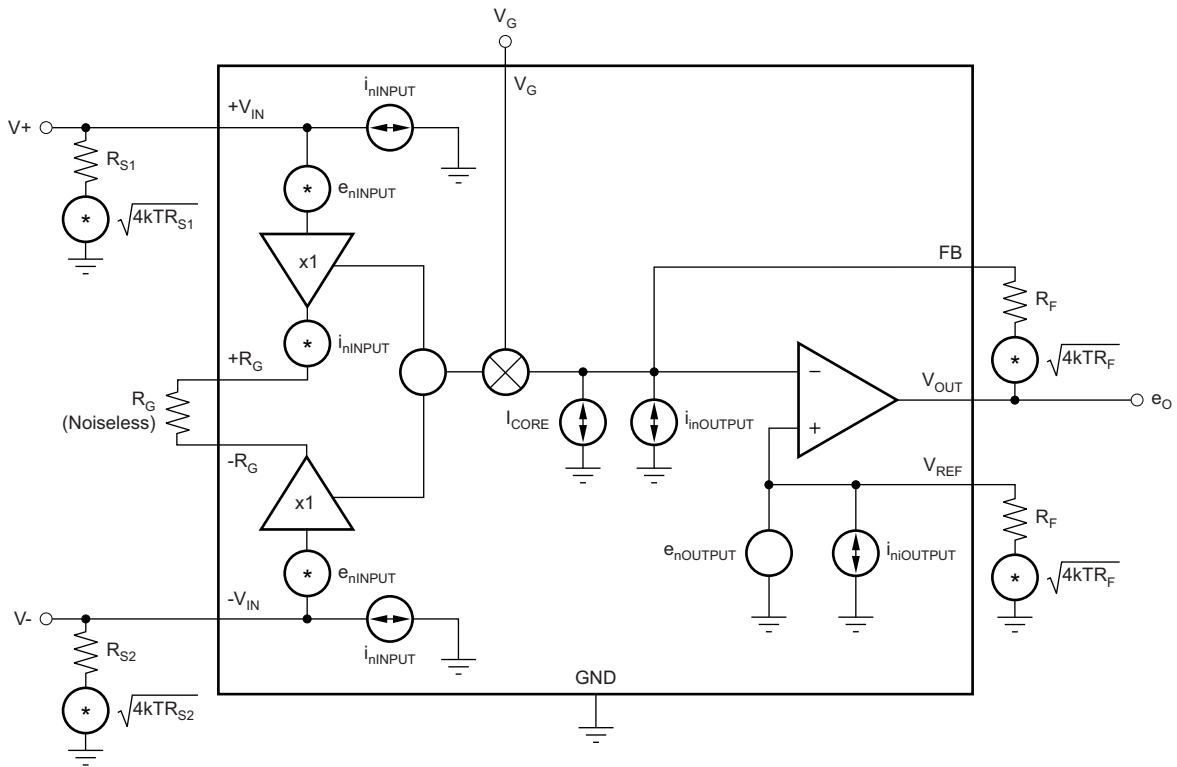

Figure 88. Full Noise Model

10 Power Supply Recommendations

High-speed amplifiers require low inductance power supply traces and low ESR bypass capacitors. The power supply voltage should be centered on the desired amplifier output voltage, so for ground referenced output signals, split supplies are required. The power supply voltage should be from 7 V to 12 V.

11 Layout

11.1 Layout Guidelines

Achieving optimum performance with a high-frequency amplifier such as the VCA820 requires careful attention to printed circuit board (PCB) layout parasitics and external component types. Recommendations to optimize performance include:

- Minimize parasitic capacitance to any ac ground for all of the signal I/O pins. This recommendation includes the ground pin (pin 2). Parasitic capacitance on the output can cause instability: on both the inverting input and the noninverting input, it can react with the source impedance to cause unintentional band limiting. To reduce unwanted capacitance, a window around the signal I/O pins should be opened in all of the ground and power planes around those pins. Otherwise, ground and power planes should be unbroken elsewhere on the board. Place a small series resistance (greater than 25 Ω) with the input pin connected to ground to help decouple package parasitics.
- Minimize the distance (less than 0.25") from the power-supply pins to high-frequency 0.1- μ F decoupling capacitors. At the device pins, the ground and power plane layout should not be in close proximity to the signal I/O pins. Avoid narrow power and ground traces to minimize inductance between the pins and the decoupling capacitors. The power-supply connections should always be decoupled with these capacitors. Larger (2.2 μ F to 6.8 μ F) decoupling capacitors, effective at lower frequencies, should also be used on the main supply pins. These capacitors may be placed somewhat farther from the device and may be shared among several devices in the same area of the PCB.
- Careful selection and placement of external components preserve the high-frequency performance of the VCA820. Resistors should be a very low reactance type. Surface-mount resistors work best and allow a tighter overall layout. Metal-film and carbon composition, axially-leaded resistors can also provide good high-frequency performance. Again, keep the leads and PCB trace length as short as possible. Never use wire-wound type resistors in a high-frequency application. Because the output pin is the most sensitive to parasitic capacitance, always position the series output resistor, if any, as close as possible to the output pin. Other network components, such as inverting or non-inverting input termination resistors, should also be placed close to the package.
- Connections to other wideband devices on the board may be made with short direct traces or through onboard transmission lines. For short connections, consider the trace and the input to the next device as a lumped capacitive load. Relatively wide traces (50 mils to 100 mils, or 1.27 mm to 2.54 mm) should be used, preferably with ground and power planes opened up around them.
- Socketing a high-speed part like the VCA820 is not recommended. The additional lead length and pin-to-pin capacitance introduced by the socket can create an extremely troublesome parasitic network, which can make it almost impossible to achieve a smooth, stable frequency response. Best results are obtained by soldering the VCA820 onto the board.

11.2 Layout Example

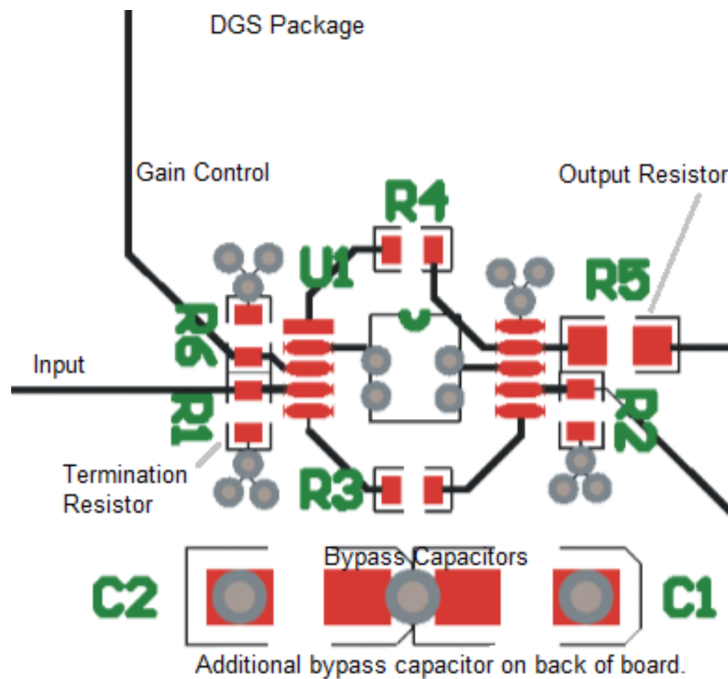

Figure 89. VCA820 Recommended Layout

11.3 Thermal Considerations

The VCA820 does not require heatsinking or airflow in most applications. The maximum desired junction temperature sets the maximum allowed internal power dissipation as described in this section. In no case should the maximum junction temperature be allowed to exceed +150°C.

Operating junction temperature (T_J) is given by [Equation 6](#):

$$T_J = T_A + P_D \times \theta_{JA} \quad (6)$$

The total internal power dissipation (P_D) is the sum of quiescent power (P_{DQ}) and additional power dissipated in the output stage (P_{DL}) to deliver load power. Quiescent power is simply the specified no-load supply current times the total supply voltage across the part. P_{DL} depends on the required output signal and load; for a grounded resistive load, however, it is at a maximum when the output is fixed at a voltage equal to one-half of either supply voltage (for equal bipolar supplies). Under this worst-case condition, $P_{DL} = V_S^2 / (4 \times R_L)$, where R_L is the resistive load.

Note that it is the power in the output stage and not in the load that determines internal power dissipation. As a worst-case example, compute the maximum T_J using a VCA820ID (SO-14 package) in the circuit of [Figure 76](#) operating at maximum gain and at the maximum specified ambient temperature of +85°C with a DC output voltage at half the supply into a 100-ohm load.

$$P_D = 10V(38mA) + 5^2 / (4 \times 100\Omega) = 442.5mW \quad (7)$$

$$\text{Maximum } T_J = +85^\circ\text{C} + (0.449W \times 80^\circ\text{C/W}) = 120.5^\circ\text{C} \quad (8)$$

This maximum operating junction temperature is well below most system level targets. Most applications should be lower because an absolute worst-case output stage power was assumed in this calculation of $V_{CC}/2$, which is beyond the output voltage range for the VCA820.

12 Device and Documentation Support

12.1 Device Support

12.1.1 Third-Party Products Disclaimer

TI'S PUBLICATION OF INFORMATION REGARDING THIRD-PARTY PRODUCTS OR SERVICES DOES NOT CONSTITUTE AN ENDORSEMENT REGARDING THE SUITABILITY OF SUCH PRODUCTS OR SERVICES OR A WARRANTY, REPRESENTATION OR ENDORSEMENT OF SUCH PRODUCTS OR SERVICES, EITHER ALONE OR IN COMBINATION WITH ANY TI PRODUCT OR SERVICE.

12.2 Community Resources

The following links connect to TI community resources. Linked contents are provided "AS IS" by the respective contributors. They do not constitute TI specifications and do not necessarily reflect TI's views; see TI's [Terms of Use](#).

TI E2E™ Online Community *TI's Engineer-to-Engineer (E2E) Community*. Created to foster collaboration among engineers. At e2e.ti.com, you can ask questions, share knowledge, explore ideas and help solve problems with fellow engineers.

Design Support *TI's Design Support* Quickly find helpful E2E forums along with design support tools and contact information for technical support.

12.3 Trademarks

E2E is a trademark of Texas Instruments.

X2Y is a registered trademark of X2Y Attenuators LLC.

All other trademarks are the property of their respective owners.

12.4 Electrostatic Discharge Caution



These devices have limited built-in ESD protection. The leads should be shorted together or the device placed in conductive foam during storage or handling to prevent electrostatic damage to the MOS gates.

12.5 Glossary

SLYZ022 — *TI Glossary*.

This glossary lists and explains terms, acronyms, and definitions.

13 Mechanical, Packaging, and Orderable Information

The following pages include mechanical, packaging, and orderable information. This information is the most current data available for the designated devices. This data is subject to change without notice and revision of this document. For browser-based versions of this data sheet, refer to the left-hand navigation.

PACKAGING INFORMATION

Orderable Device	Status (1)	Package Type	Package Drawing	Pins	Package Qty	Eco Plan (2)	Lead/Ball Finish (6)	MSL Peak Temp (3)	Op Temp (°C)	Device Marking (4/5)	Samples
VCA820ID	ACTIVE	SOIC	D	14	50	Green (RoHS & no Sb/Br)	CU NIPDAU	Level-2-260C-1 YEAR	-40 to 85	VCA820ID	Samples
VCA820IDG4	ACTIVE	SOIC	D	14	50	Green (RoHS & no Sb/Br)	CU NIPDAU	Level-2-260C-1 YEAR	-40 to 85	VCA820ID	Samples
VCA820IDGSR	ACTIVE	VSSOP	DGS	10	2500	Green (RoHS & no Sb/Br)	CU NIPDAU CU NIPDAUAG	Level-2-260C-1 YEAR	-40 to 85	BOQ	Samples
VCA820IDGST	ACTIVE	VSSOP	DGS	10	250	Green (RoHS & no Sb/Br)	CU NIPDAU CU NIPDAUAG	Level-2-260C-1 YEAR	-40 to 85	BOQ	Samples
VCA820IDGSTG4	ACTIVE	VSSOP	DGS	10	250	Green (RoHS & no Sb/Br)	CU NIPDAU	Level-2-260C-1 YEAR	-40 to 85	BOQ	Samples
VCA820IDR	ACTIVE	SOIC	D	14	2500	Green (RoHS & no Sb/Br)	CU NIPDAU	Level-2-260C-1 YEAR	-40 to 85	VCA820ID	Samples

(1) The marketing status values are defined as follows:

ACTIVE: Product device recommended for new designs.

LIFEBUY: TI has announced that the device will be discontinued, and a lifetime-buy period is in effect.

NRND: Not recommended for new designs. Device is in production to support existing customers, but TI does not recommend using this part in a new design.

PREVIEW: Device has been announced but is not in production. Samples may or may not be available.

OBSOLETE: TI has discontinued the production of the device.

(2) Eco Plan - The planned eco-friendly classification: Pb-Free (RoHS), Pb-Free (RoHS Exempt), or Green (RoHS & no Sb/Br) - please check <http://www.ti.com/productcontent> for the latest availability information and additional product content details.

TBD: The Pb-Free/Green conversion plan has not been defined.

Pb-Free (RoHS): TI's terms "Lead-Free" or "Pb-Free" mean semiconductor products that are compatible with the current RoHS requirements for all 6 substances, including the requirement that lead not exceed 0.1% by weight in homogeneous materials. Where designed to be soldered at high temperatures, TI Pb-Free products are suitable for use in specified lead-free processes.

Pb-Free (RoHS Exempt): This component has a RoHS exemption for either 1) lead-based flip-chip solder bumps used between the die and package, or 2) lead-based die adhesive used between the die and leadframe. The component is otherwise considered Pb-Free (RoHS compatible) as defined above.

Green (RoHS & no Sb/Br): TI defines "Green" to mean Pb-Free (RoHS compatible), and free of Bromine (Br) and Antimony (Sb) based flame retardants (Br or Sb do not exceed 0.1% by weight in homogeneous material)

(3) MSL, Peak Temp. - The Moisture Sensitivity Level rating according to the JEDEC industry standard classifications, and peak solder temperature.

(4) There may be additional marking, which relates to the logo, the lot trace code information, or the environmental category on the device.

(5) Multiple Device Markings will be inside parentheses. Only one Device Marking contained in parentheses and separated by a "~" will appear on a device. If a line is indented then it is a continuation of the previous line and the two combined represent the entire Device Marking for that device.

⁽⁶⁾ Lead/Ball Finish - Orderable Devices may have multiple material finish options. Finish options are separated by a vertical ruled line. Lead/Ball Finish values may wrap to two lines if the finish value exceeds the maximum column width.

Important Information and Disclaimer: The information provided on this page represents TI's knowledge and belief as of the date that it is provided. TI bases its knowledge and belief on information provided by third parties, and makes no representation or warranty as to the accuracy of such information. Efforts are underway to better integrate information from third parties. TI has taken and continues to take reasonable steps to provide representative and accurate information but may not have conducted destructive testing or chemical analysis on incoming materials and chemicals. TI and TI suppliers consider certain information to be proprietary, and thus CAS numbers and other limited information may not be available for release.

In no event shall TI's liability arising out of such information exceed the total purchase price of the TI part(s) at issue in this document sold by TI to Customer on an annual basis.

TAPE AND REEL INFORMATION



QUADRANT ASSIGNMENTS FOR PIN 1 ORIENTATION IN TAPE



*All dimensions are nominal

Device	Package Type	Package Drawing	Pins	SPQ	Reel Diameter (mm)	Reel Width W1 (mm)	A0 (mm)	B0 (mm)	K0 (mm)	P1 (mm)	W (mm)	Pin1 Quadrant
VCA820IDGSR	VSSOP	DGS	10	2500	330.0	12.4	5.3	3.4	1.4	8.0	12.0	Q1
VCA820IDGST	VSSOP	DGS	10	250	180.0	12.4	5.3	3.4	1.4	8.0	12.0	Q1
VCA820IDR	SOIC	D	14	2500	330.0	16.4	6.5	9.0	2.1	8.0	16.0	Q1

TAPE AND REEL BOX DIMENSIONS

*All dimensions are nominal

Device	Package Type	Package Drawing	Pins	SPQ	Length (mm)	Width (mm)	Height (mm)
VCA820IDGSR	VSSOP	DGS	10	2500	367.0	367.0	35.0
VCA820IDGST	VSSOP	DGS	10	250	210.0	185.0	35.0
VCA820IDR	SOIC	D	14	2500	367.0	367.0	38.0

DGS (S-PDSO-G10)

PLASTIC SMALL-OUTLINE PACKAGE

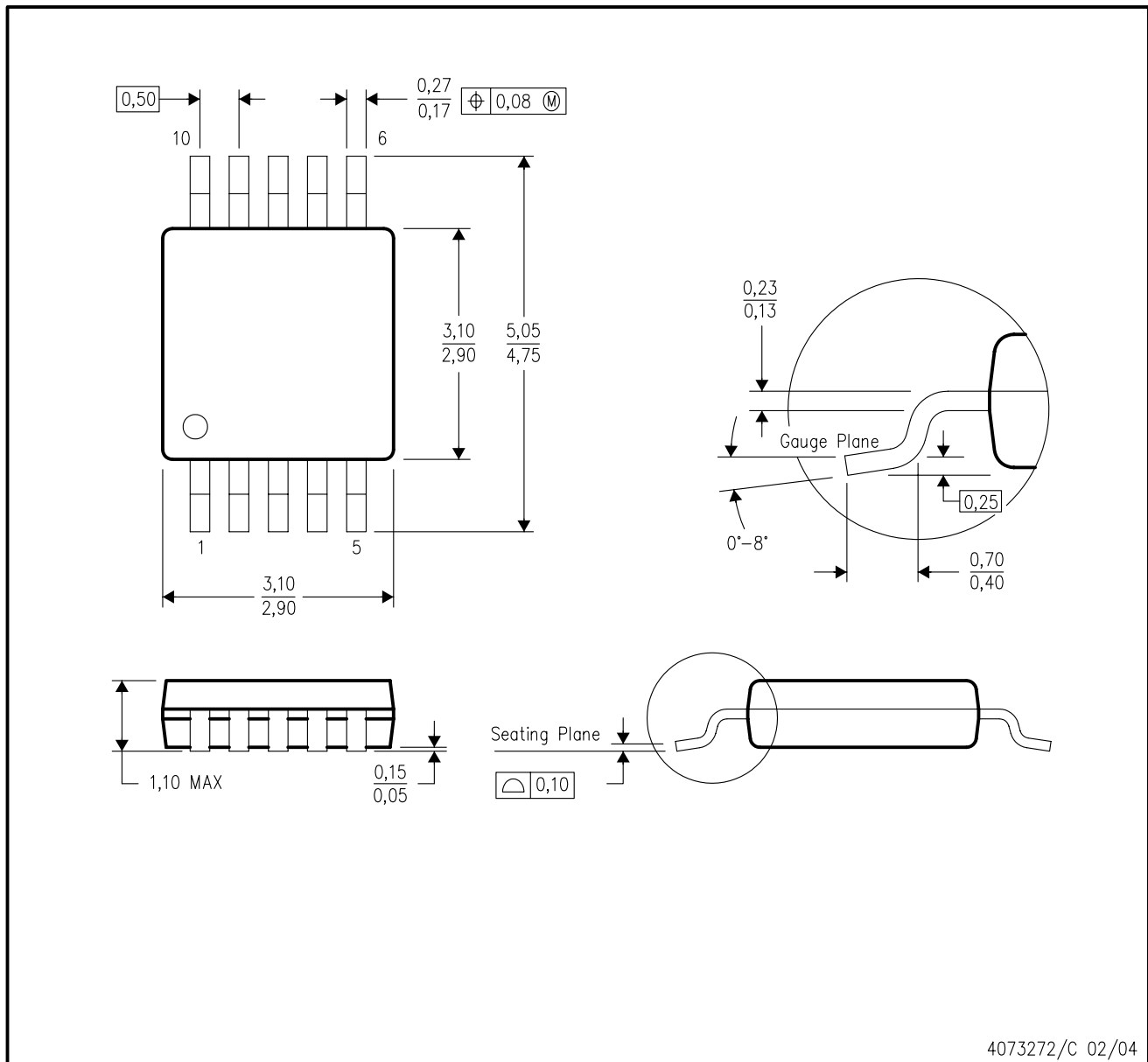

- NOTES:
- A. All linear dimensions are in millimeters.
 - B. This drawing is subject to change without notice.
 - C. Body dimensions do not include mold flash or protrusion.
 - D. Falls within JEDEC MO-187 variation BA.

DGS (S-PDSO-G10)

PLASTIC SMALL OUTLINE PACKAGE

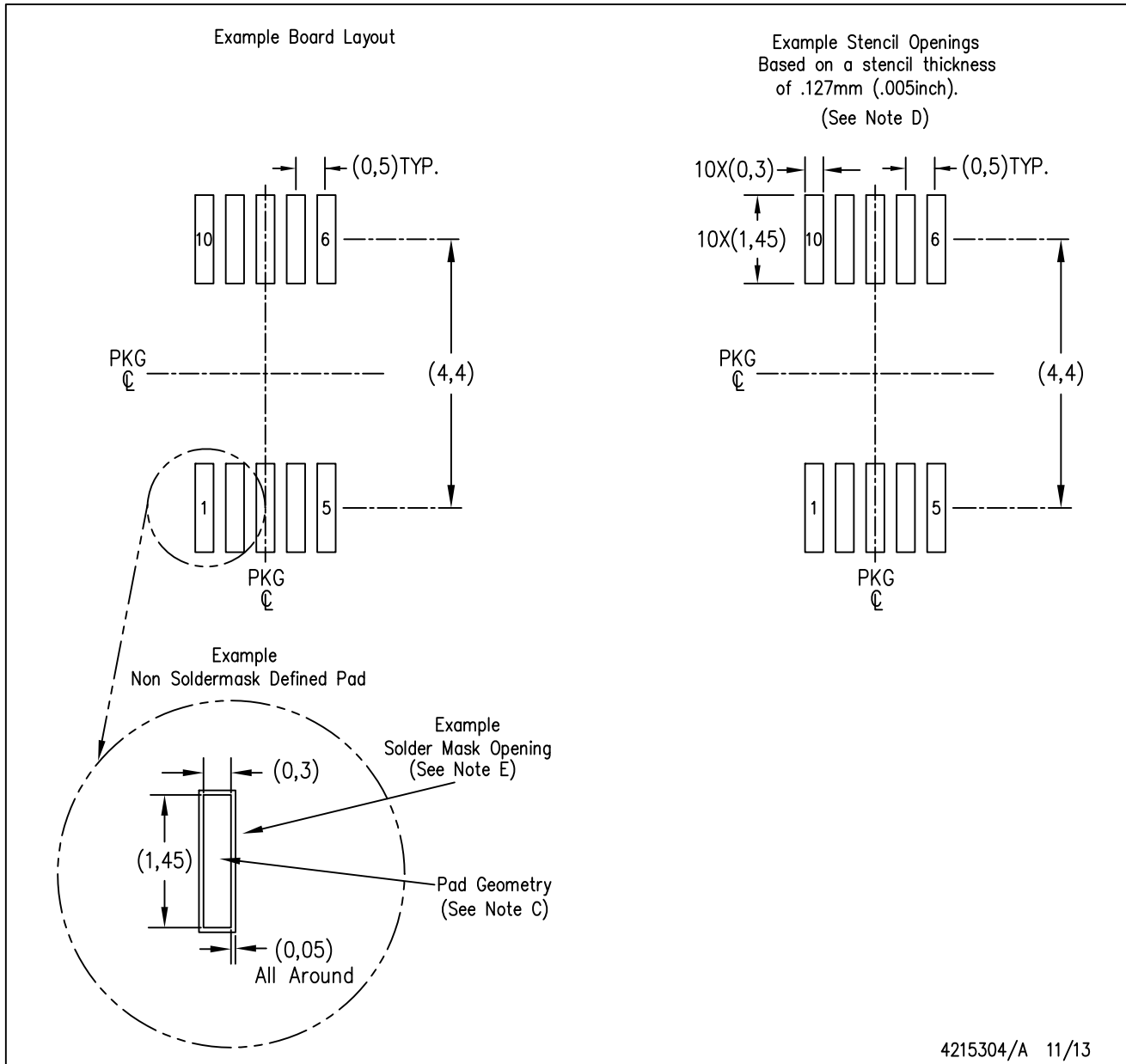



- NOTES:
- A. All linear dimensions are in millimeters.
 - B. This drawing is subject to change without notice.
 - C. Publication IPC-7351 is recommended for alternate designs.
 - D. Laser cutting apertures with trapezoidal walls and also rounding corners will offer better paste release. Customers should contact their board assembly site for stencil design recommendations. Refer to IPC-7525 for other stencil recommendations.
 - E. Customers should contact their board fabrication site for solder mask tolerances between and around signal pads.

D (R-PDSO-G14)

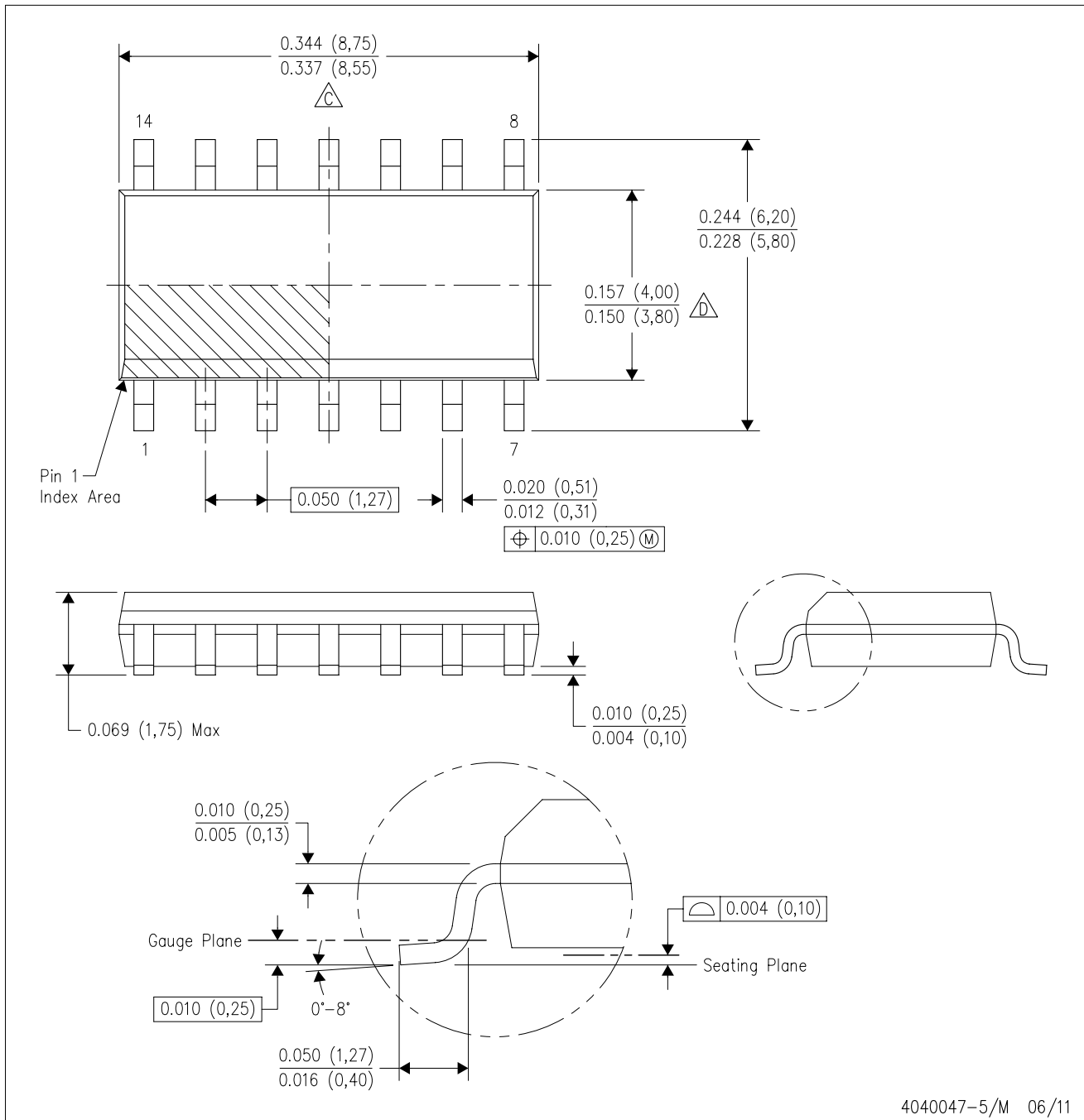
PLASTIC SMALL OUTLINE



4040047-5/M 06/11

- NOTES:
- A. All linear dimensions are in inches (millimeters).
 - B. This drawing is subject to change without notice.
 -  Body length does not include mold flash, protrusions, or gate burrs. Mold flash, protrusions, or gate burrs shall not exceed 0.006 (0,15) each side.
 -  Body width does not include interlead flash. Interlead flash shall not exceed 0.017 (0,43) each side.
 - E. Reference JEDEC MS-012 variation AB.

D (R-PDSO-G14)

PLASTIC SMALL OUTLINE

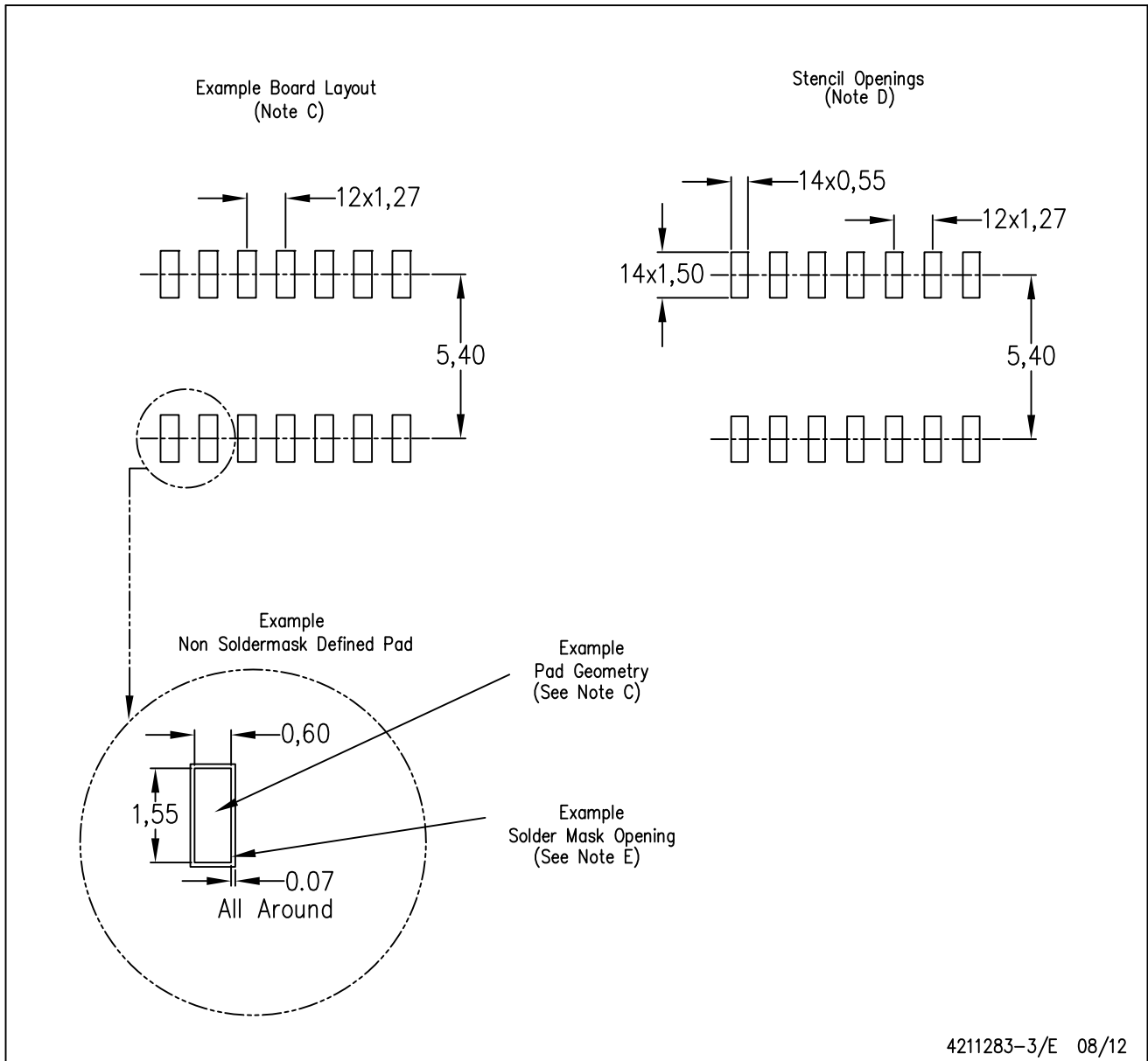

- NOTES:
- A. All linear dimensions are in millimeters.
 - B. This drawing is subject to change without notice.
 - C. Publication IPC-7351 is recommended for alternate designs.
 - D. Laser cutting apertures with trapezoidal walls and also rounding corners will offer better paste release. Customers should contact their board assembly site for stencil design recommendations. Refer to IPC-7525 for other stencil recommendations.
 - E. Customers should contact their board fabrication site for solder mask tolerances between and around signal pads.

IMPORTANT NOTICE

Texas Instruments Incorporated and its subsidiaries (TI) reserve the right to make corrections, enhancements, improvements and other changes to its semiconductor products and services per JESD46, latest issue, and to discontinue any product or service per JESD48, latest issue. Buyers should obtain the latest relevant information before placing orders and should verify that such information is current and complete. All semiconductor products (also referred to herein as "components") are sold subject to TI's terms and conditions of sale supplied at the time of order acknowledgment.

TI warrants performance of its components to the specifications applicable at the time of sale, in accordance with the warranty in TI's terms and conditions of sale of semiconductor products. Testing and other quality control techniques are used to the extent TI deems necessary to support this warranty. Except where mandated by applicable law, testing of all parameters of each component is not necessarily performed.

TI assumes no liability for applications assistance or the design of Buyers' products. Buyers are responsible for their products and applications using TI components. To minimize the risks associated with Buyers' products and applications, Buyers should provide adequate design and operating safeguards.

TI does not warrant or represent that any license, either express or implied, is granted under any patent right, copyright, mask work right, or other intellectual property right relating to any combination, machine, or process in which TI components or services are used. Information published by TI regarding third-party products or services does not constitute a license to use such products or services or a warranty or endorsement thereof. Use of such information may require a license from a third party under the patents or other intellectual property of the third party, or a license from TI under the patents or other intellectual property of TI.

Reproduction of significant portions of TI information in TI data books or data sheets is permissible only if reproduction is without alteration and is accompanied by all associated warranties, conditions, limitations, and notices. TI is not responsible or liable for such altered documentation. Information of third parties may be subject to additional restrictions.

Resale of TI components or services with statements different from or beyond the parameters stated by TI for that component or service voids all express and any implied warranties for the associated TI component or service and is an unfair and deceptive business practice. TI is not responsible or liable for any such statements.

Buyer acknowledges and agrees that it is solely responsible for compliance with all legal, regulatory and safety-related requirements concerning its products, and any use of TI components in its applications, notwithstanding any applications-related information or support that may be provided by TI. Buyer represents and agrees that it has all the necessary expertise to create and implement safeguards which anticipate dangerous consequences of failures, monitor failures and their consequences, lessen the likelihood of failures that might cause harm and take appropriate remedial actions. Buyer will fully indemnify TI and its representatives against any damages arising out of the use of any TI components in safety-critical applications.

In some cases, TI components may be promoted specifically to facilitate safety-related applications. With such components, TI's goal is to help enable customers to design and create their own end-product solutions that meet applicable functional safety standards and requirements. Nonetheless, such components are subject to these terms.

No TI components are authorized for use in FDA Class III (or similar life-critical medical equipment) unless authorized officers of the parties have executed a special agreement specifically governing such use.

Only those TI components which TI has specifically designated as military grade or "enhanced plastic" are designed and intended for use in military/aerospace applications or environments. Buyer acknowledges and agrees that any military or aerospace use of TI components which have **not** been so designated is solely at the Buyer's risk, and that Buyer is solely responsible for compliance with all legal and regulatory requirements in connection with such use.

TI has specifically designated certain components as meeting ISO/TS16949 requirements, mainly for automotive use. In any case of use of non-designated products, TI will not be responsible for any failure to meet ISO/TS16949.

Products

Audio	www.ti.com/audio
Amplifiers	amplifier.ti.com
Data Converters	dataconverter.ti.com
DLP® Products	www.dlp.com
DSP	dsp.ti.com
Clocks and Timers	www.ti.com/clocks
Interface	interface.ti.com
Logic	logic.ti.com
Power Mgmt	power.ti.com
Microcontrollers	microcontroller.ti.com
RFID	www.ti-rfid.com
OMAP Applications Processors	www.ti.com/omap
Wireless Connectivity	www.ti.com/wirelessconnectivity

Applications

Automotive and Transportation	www.ti.com/automotive
Communications and Telecom	www.ti.com/communications
Computers and Peripherals	www.ti.com/computers
Consumer Electronics	www.ti.com/consumer-apps
Energy and Lighting	www.ti.com/energy
Industrial	www.ti.com/industrial
Medical	www.ti.com/medical
Security	www.ti.com/security
Space, Avionics and Defense	www.ti.com/space-avionics-defense
Video and Imaging	www.ti.com/video

TI E2E Community

e2e.ti.com